

MOR

by Julien Renault

LIFT sofa 2SP

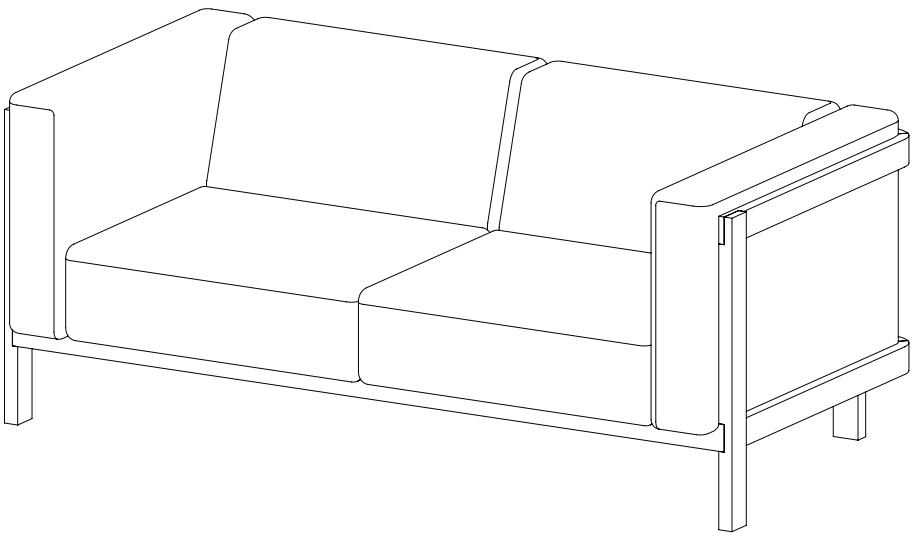

LIFT sofa 2SP

ABOUT

Inspired by the graceful mechanics of elevators and the iconic LC 2 chair by Le Corbusier, the LIFT sofa takes both its name and aesthetic cues from these influences. Crafted by the hands of Julien Renault, this masterpiece pays homage to refined design, expert craftsmanship, and unparalleled quality. Set apart from conventional sofas, the LIFT sofa boasts a distinct feature—a pristine wooden framework on its back that mirrors the contour of the cushions, unspoiled by the intrusion of bolts or screws.

Available in a range of sizes from a single seater to a spacious three-seater, the LIFT sofa collection offers versatility in its choice of ash, oak, and walnut wood options. Complementing this, a diverse selection of fabric and leather upholstery colors can be chosen to tailor the piece to your taste.

With its understated yet captivating aesthetic, the LIFT sofa effortlessly complements a multitude of environments. Its discreet charisma exudes an inviting charm that seamlessly merges comfort and sophistication.

CARE AND MAINTENANCE

The following care instructions are recommendations only.

Wood

MOR seals its veneers with a high-quality finish. For this reason, to clean solid wood and veneered surfaces, we recommend using a soft, slightly damp cloth, with a mild detergent in the case of stubborn dirt. We recommend that you always use environmentally friendly cleaning products and care for your furniture regularly and frequently. Before using any cleaning product, you should test it on an inconspicuous spot. Please follow the cleaning product manufacturer's instructions and contact a professional cleaning company in case of stubborn dirt or stains.

To avoid stains and other damage, liquids should be wiped away immediately. Wet surfaces should be dried immediately with a cloth. To extend the life of our products we apply a natural varnish to highlight and protect the properties of the natural wood. However, wood furniture reacts to environment. Exposure to light can alter its colour and also adapt its own moisture content levels to that of its environment. In the case of excessive fluctuations in temperature and humidity, however, it reacts by cracking and warping.

ROMO fabric

They are made from 63% cotton and 37% linen. ROMO advise to remove stains or liquid spills, use a clean, dry, soft towel or a sponge. Do not use bleach or other chemical solvents. The cushion cover can be washed in the washing machine. Use the gentle cycle program at 30° degrees. To wash, first close all zippers. Consult a specialist dry cleaner. If fabric has some wrinkling, use an iron in the medium temperature. As iron temperatures may vary, first test a small area before ironing the entire piece. Do not use a steamer or an iron set to the steam setting.

Leather

MOR leather elements are smooth high-quality crafted and should not be exposed to sunlight or heat sources. We recommend applying a mild cleaner once a year, to maintain the leather's natural water protective coat intact and its smoothness. For cleaning is recommended an appropriated leather cleaner in foam or liquid form, avoiding rubbing or pressure too hard and clean the entire surface, do not spot clean. Superficial dirt must be removed with a damp soft cloth, as to remove stains and in soiled spots should be applied a nonabrasive soap solution with a clean and a wet sponge. Clean well and let air dry. Do not apply direct water or wash grease spots. Do not use saddle soap, cleaning abrasive solvents, oils, furniture or shoe polishes, varnishes, detergents, or other aggressive substances. If stains remains or soiled areas persists, contact a professional cleaner. Remember that leather will age over time and create its own unique and lovely patina.

ASSEMBLY INSTRUCTIONS

1. The structure comes already assembled.

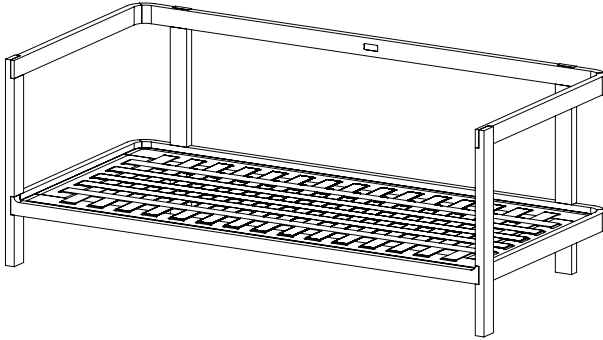

2. Place the cushions.

