

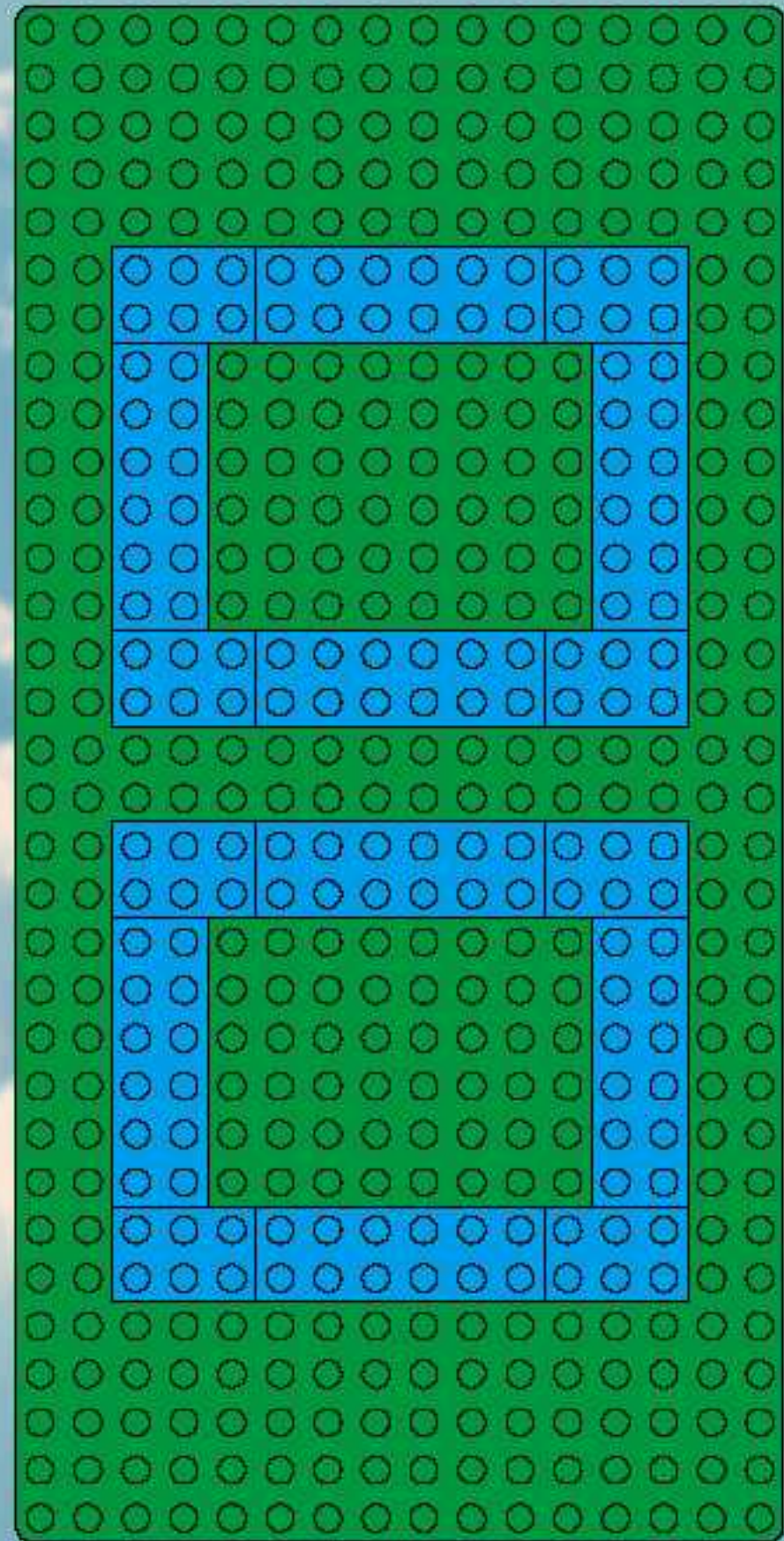

Minifigure

3 7 2 3

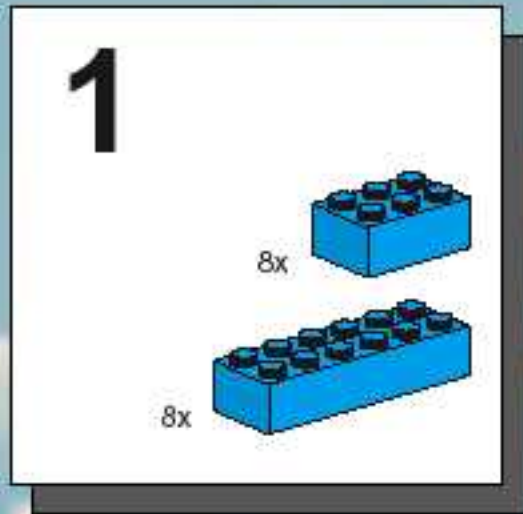

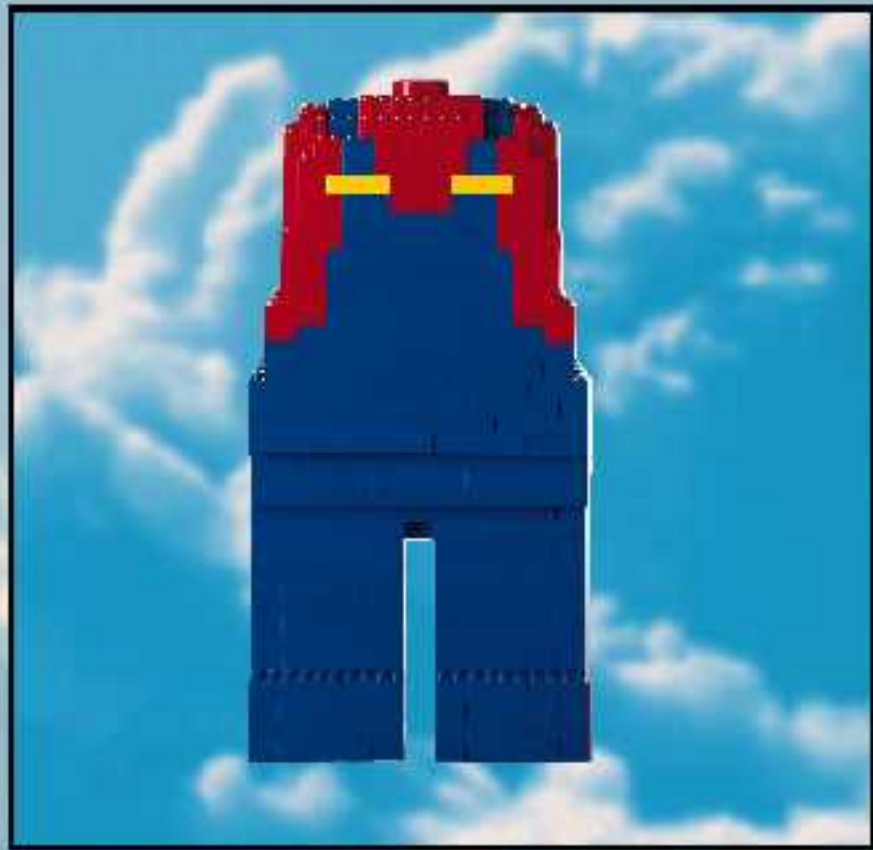

2

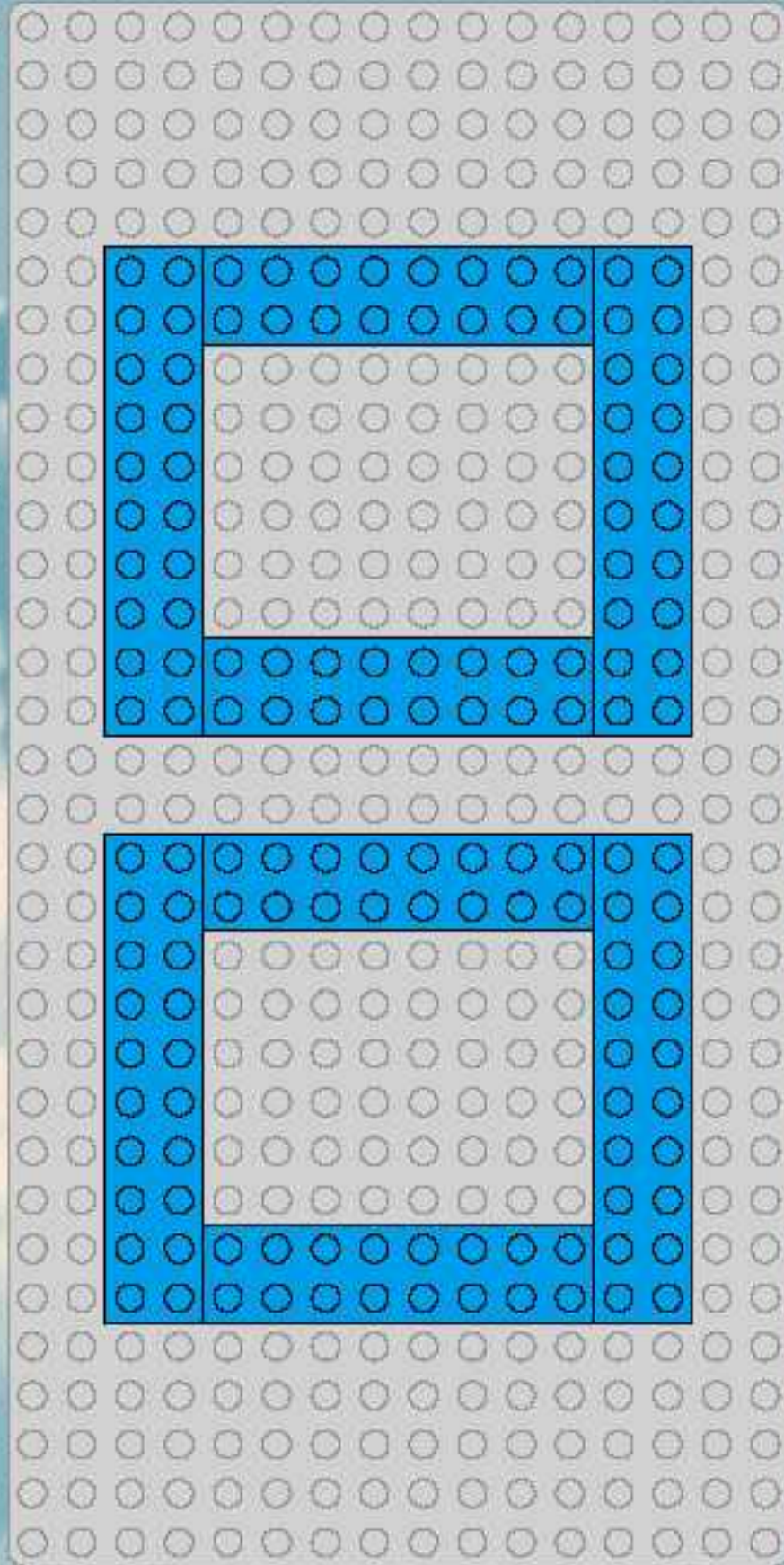

3

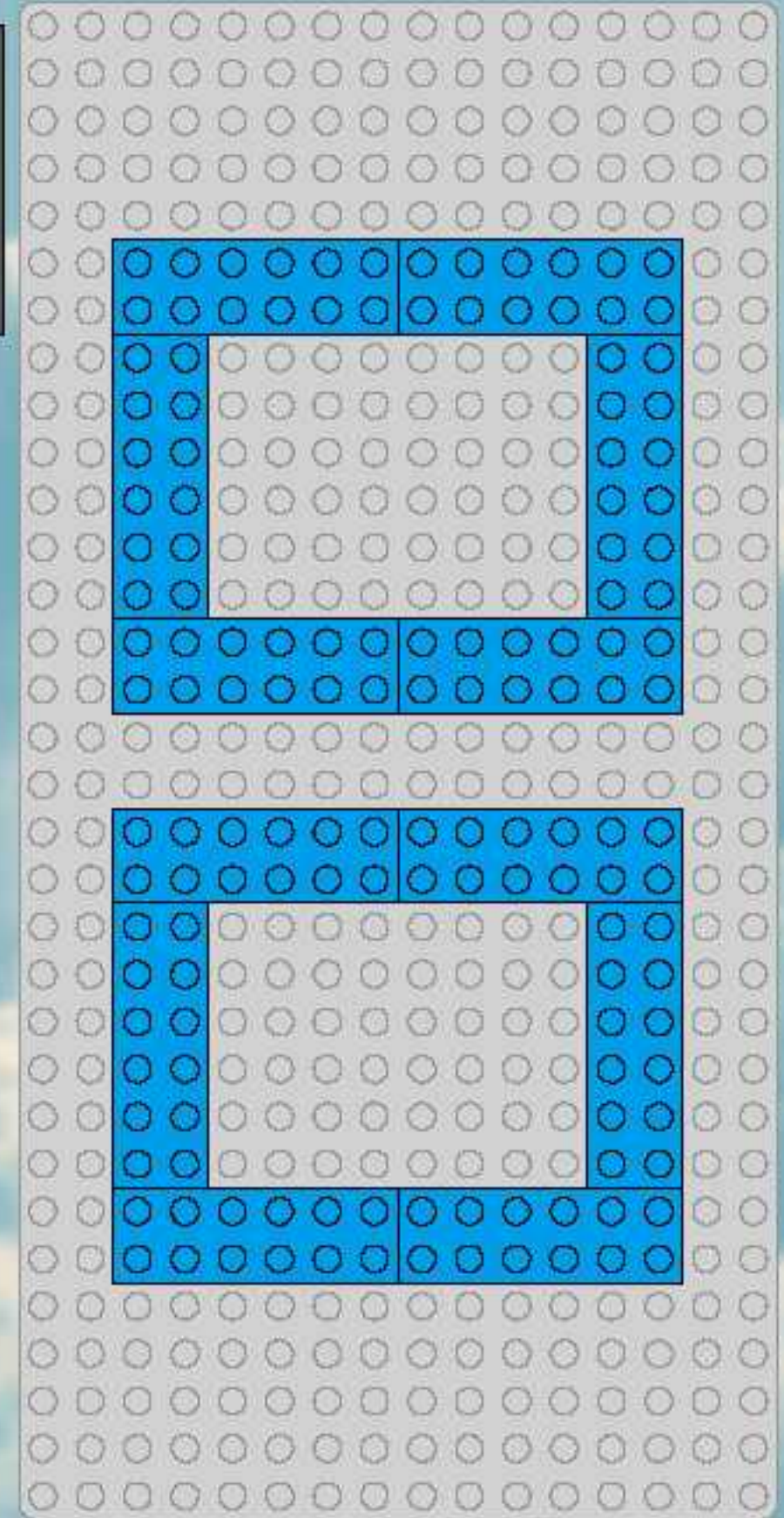

4

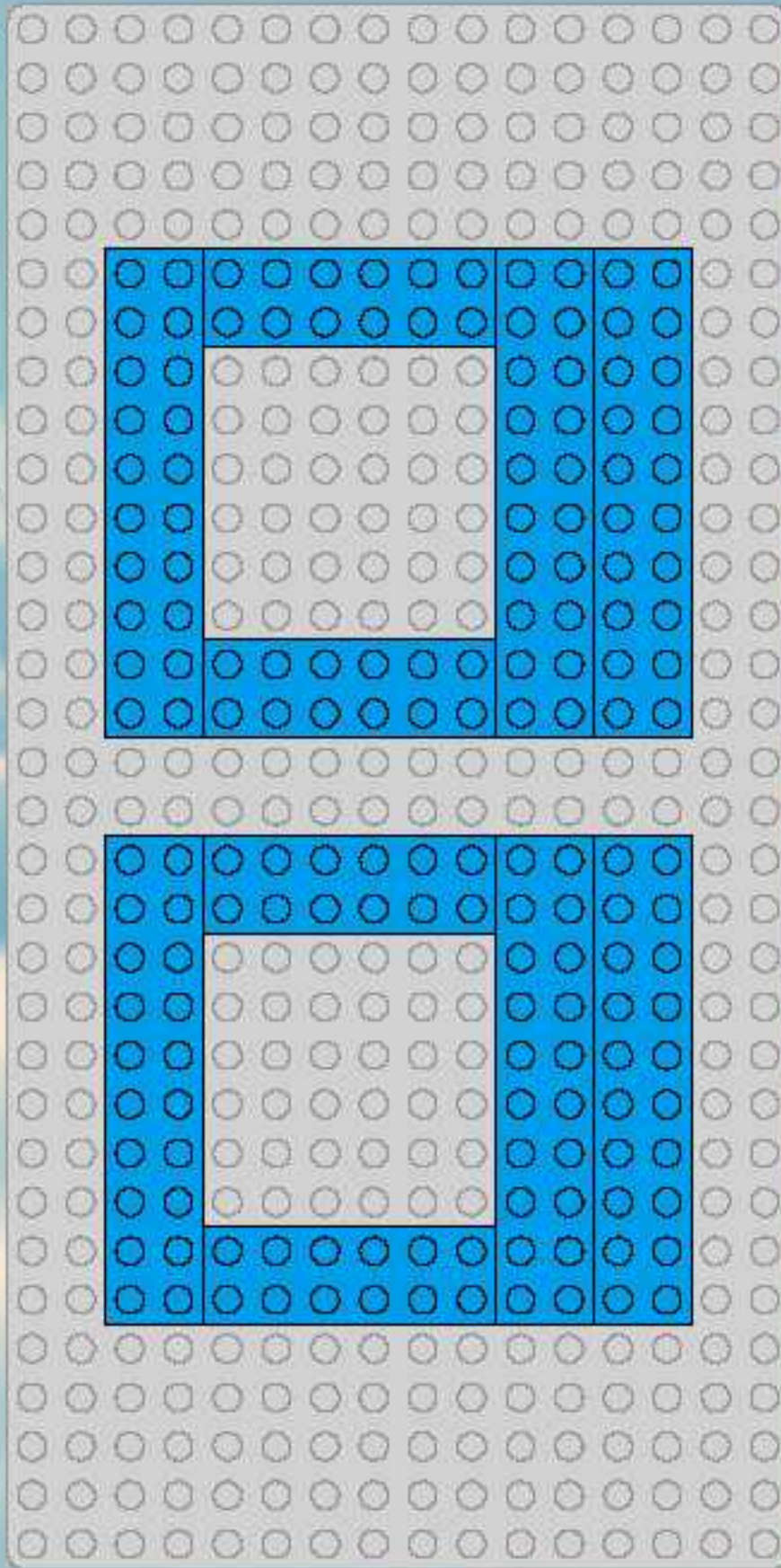

5

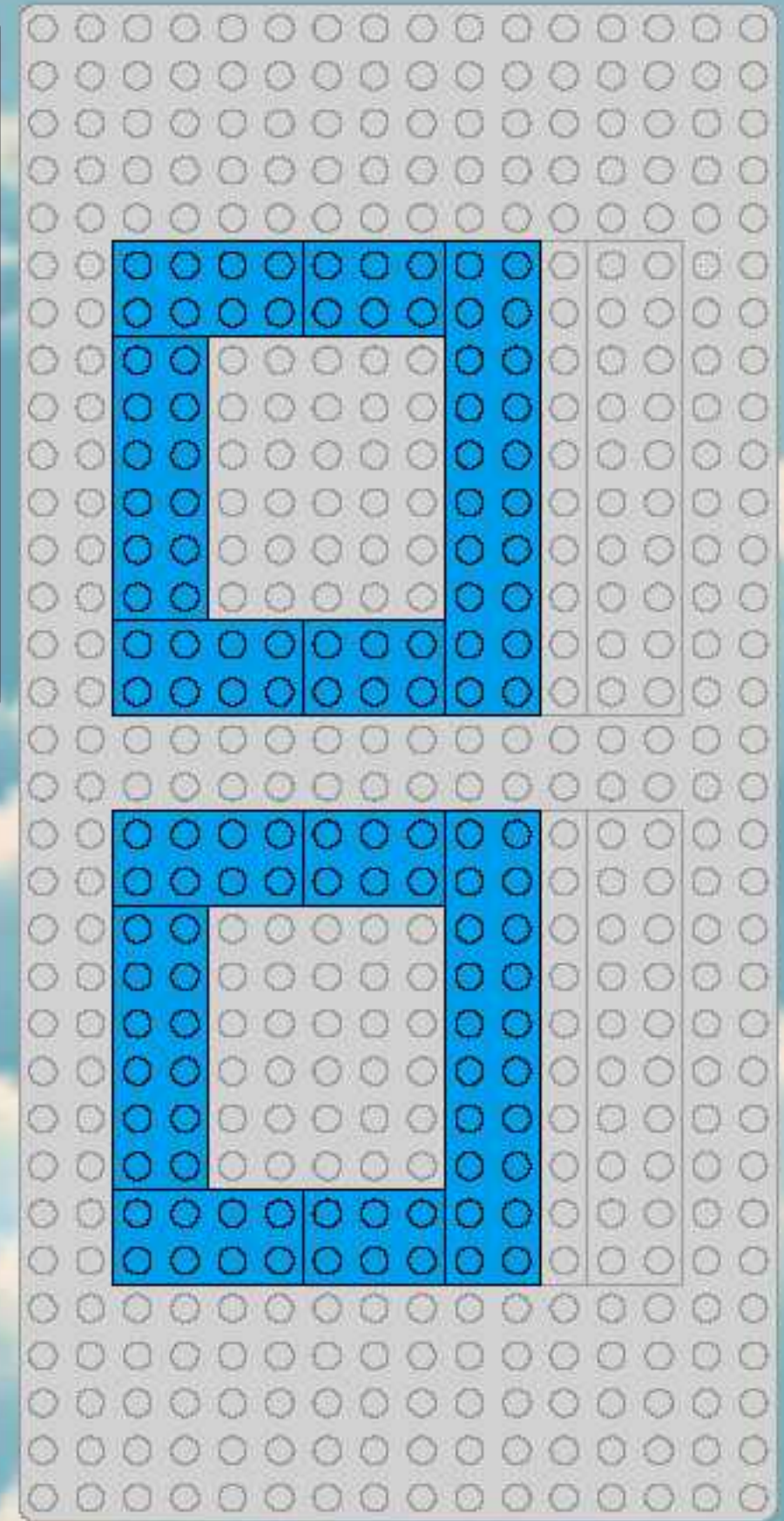

6

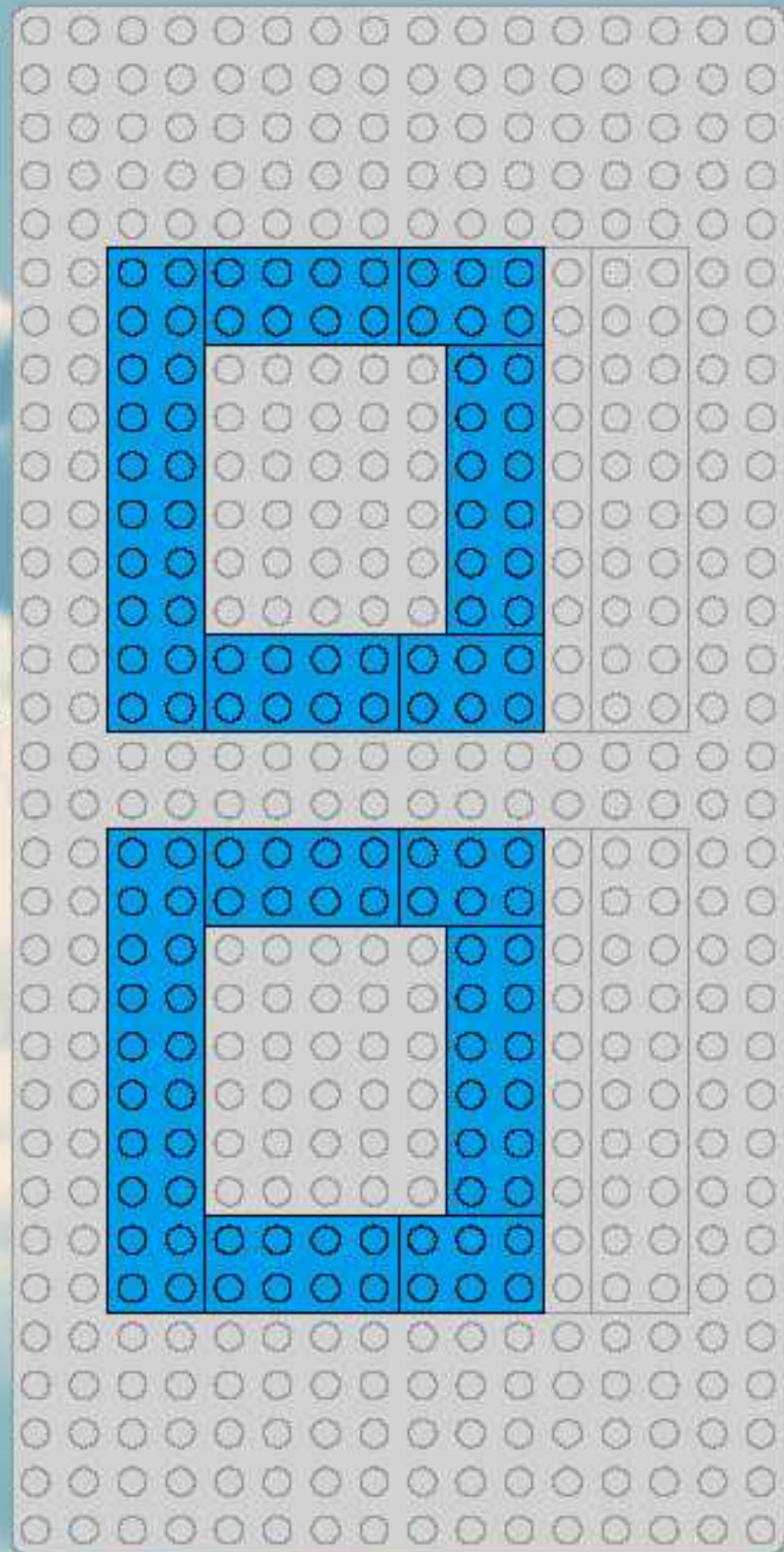
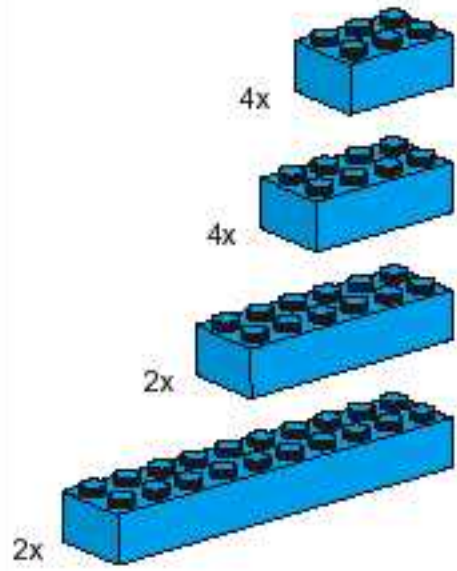

7

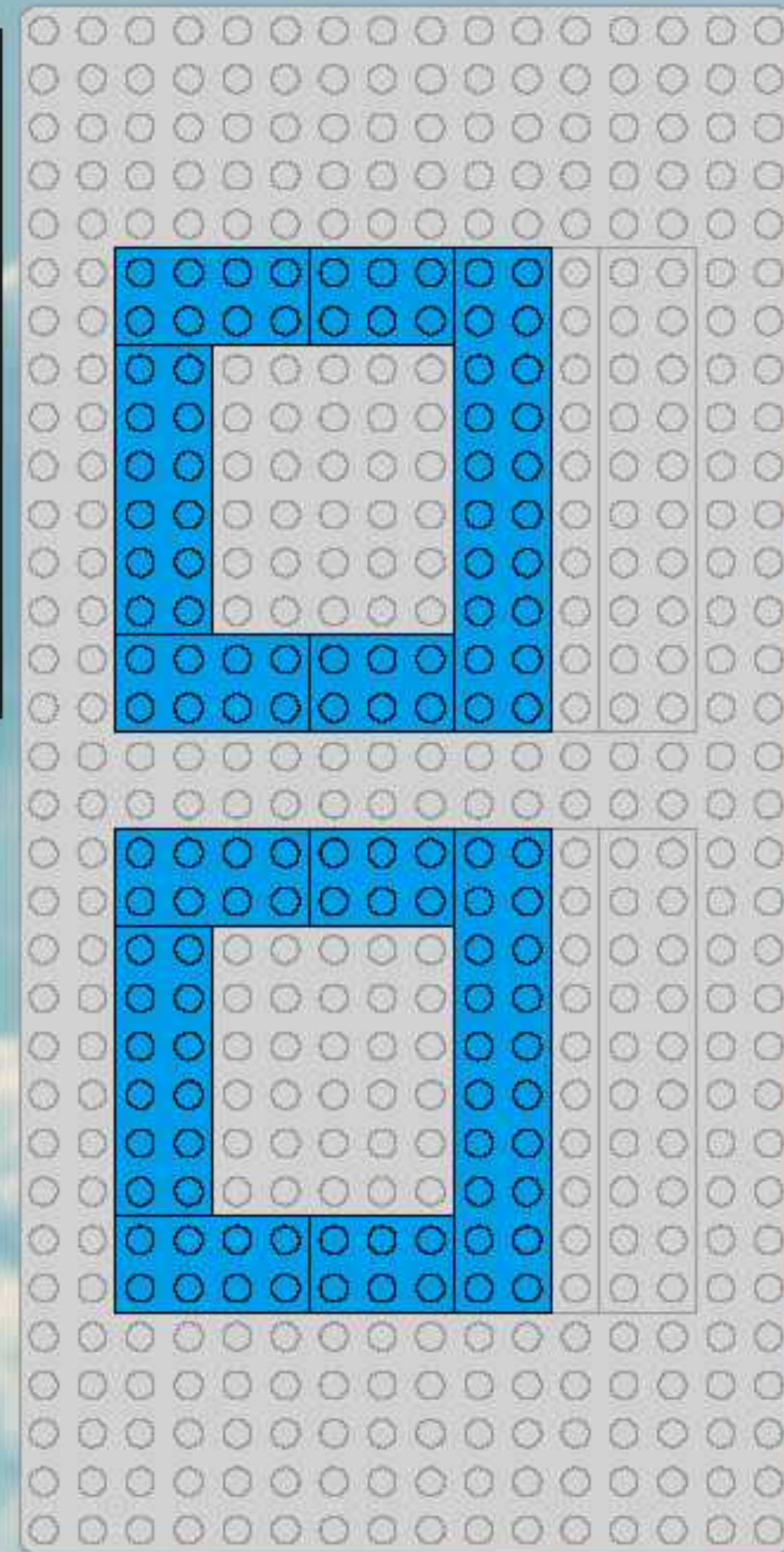
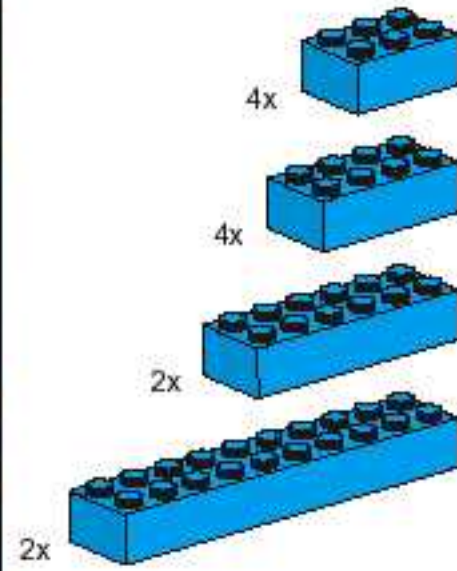

8

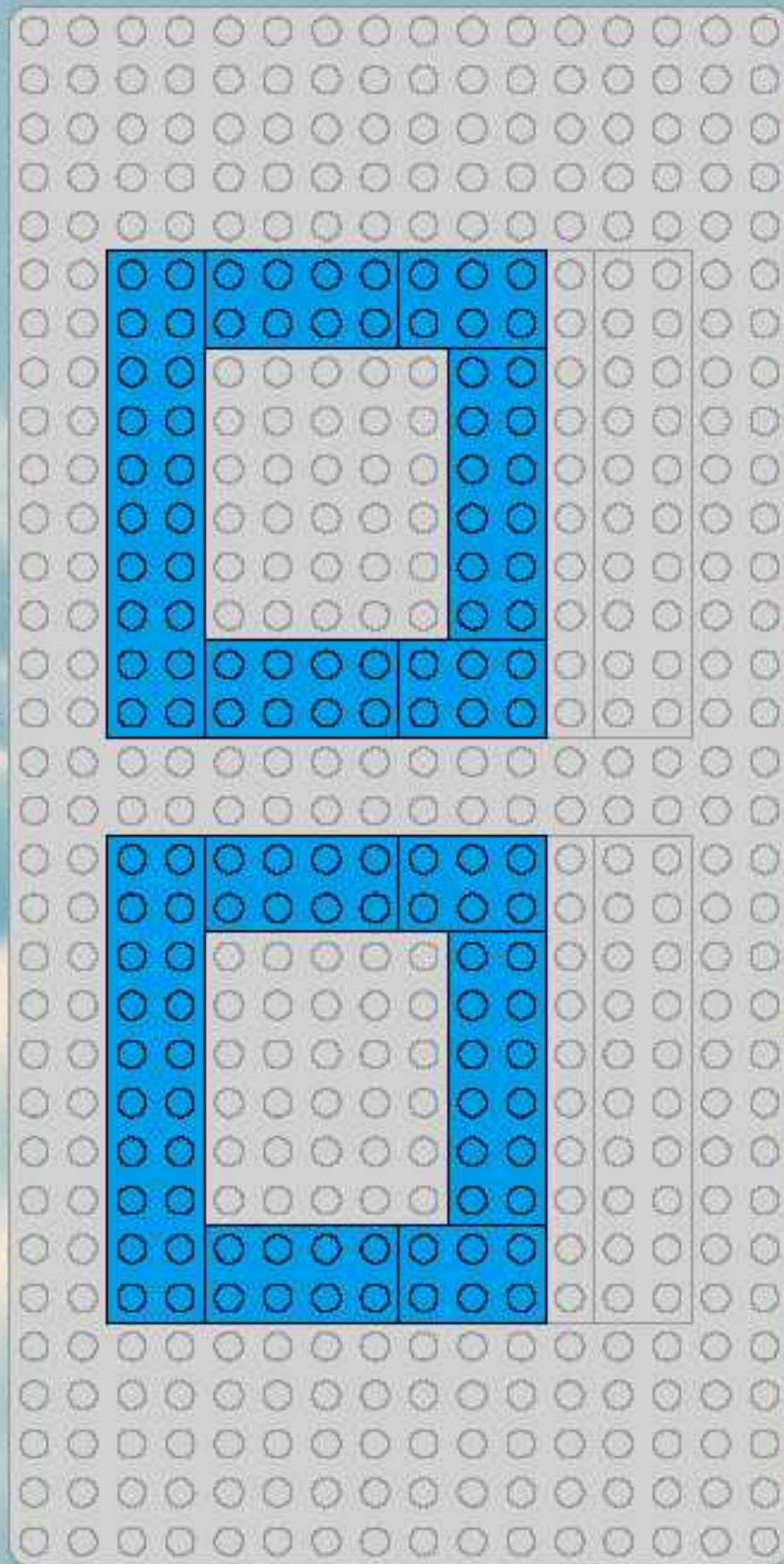
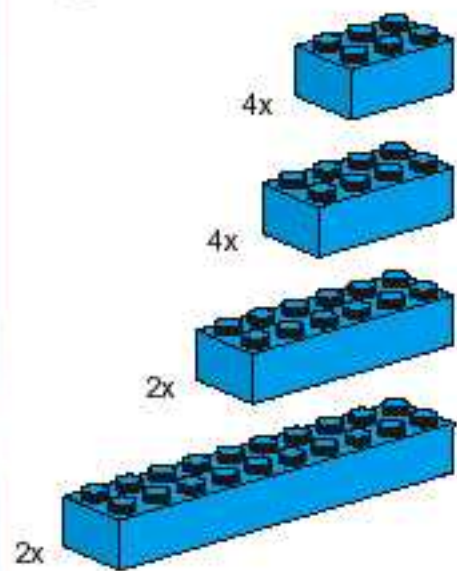

9

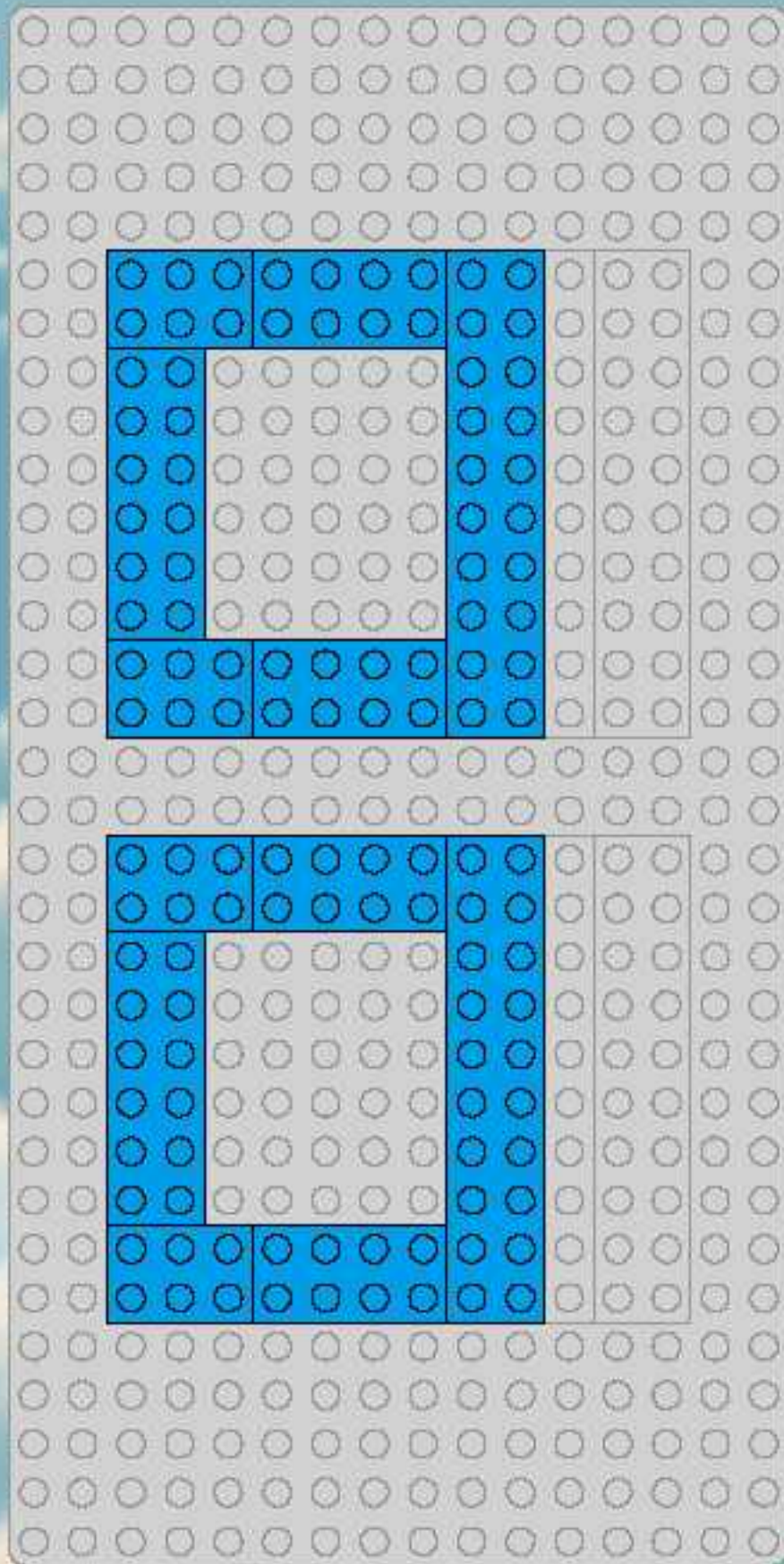
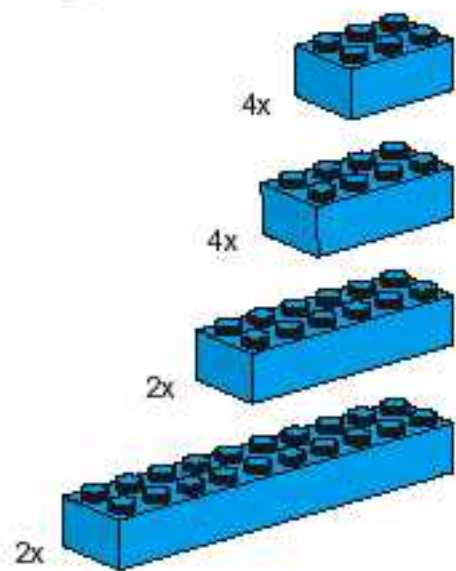

10

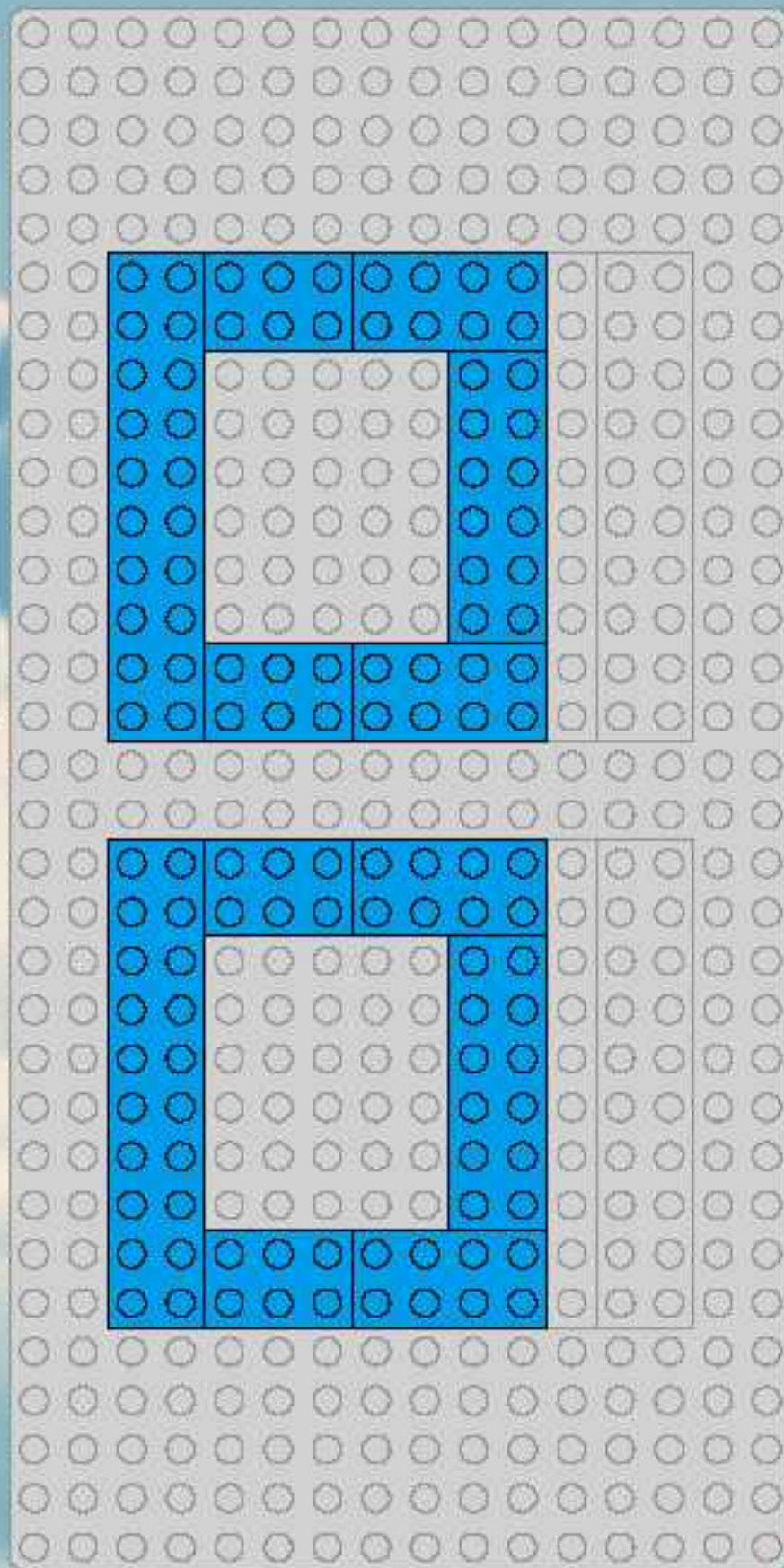
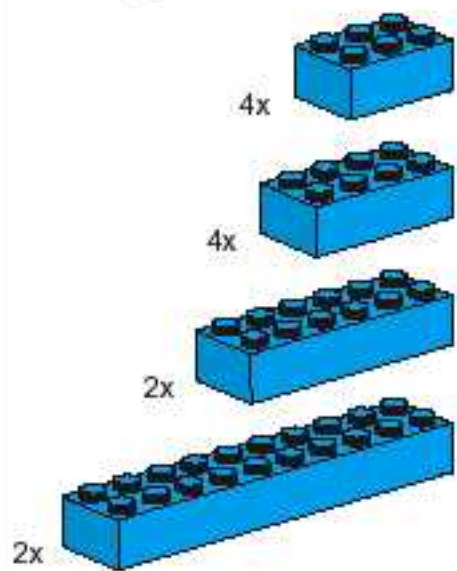

11

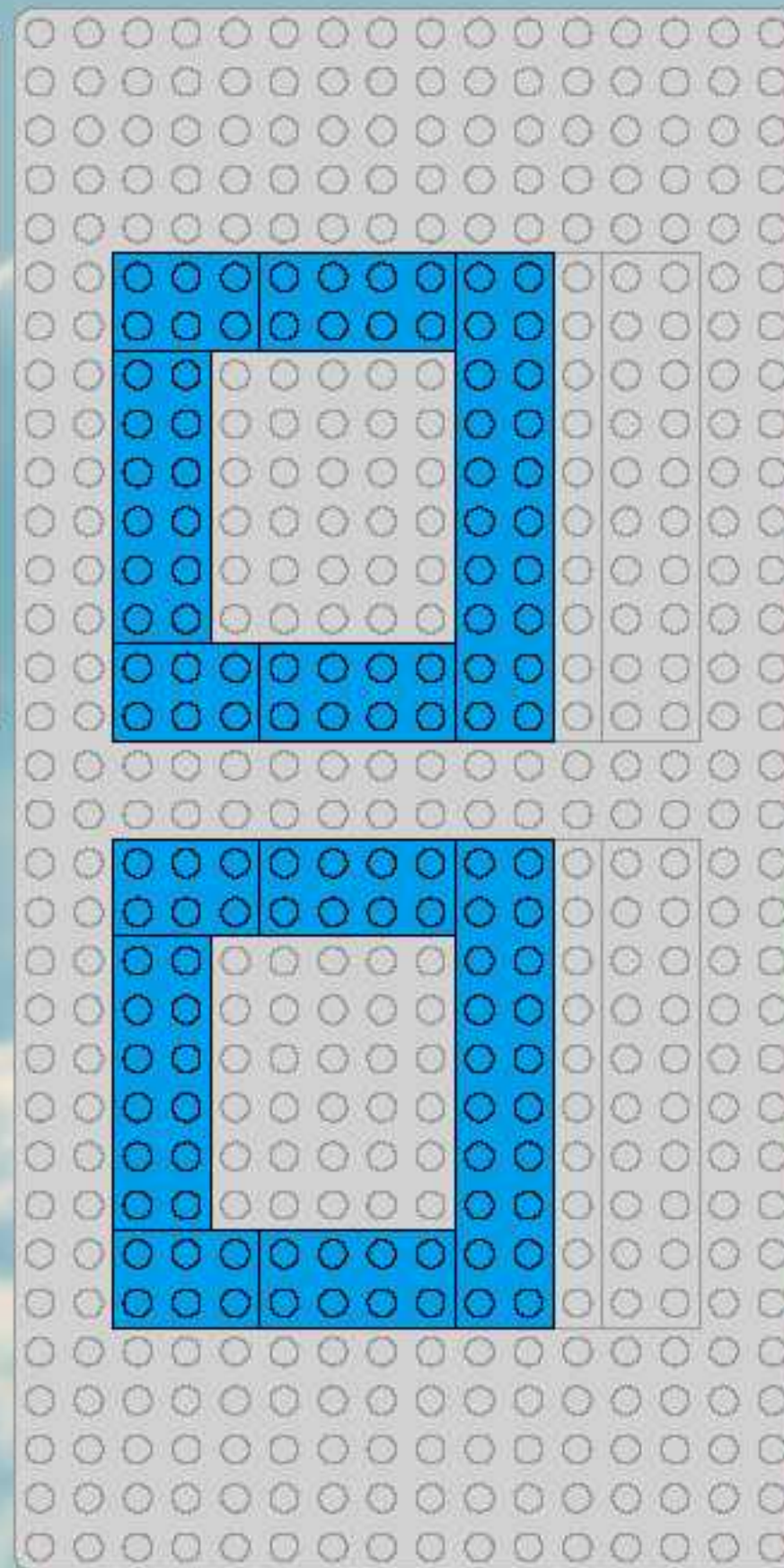
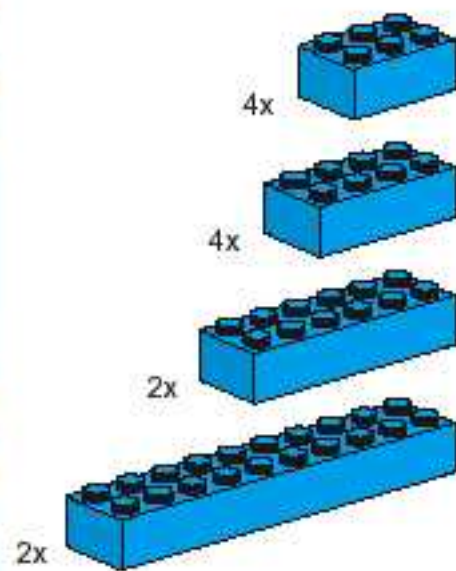

12

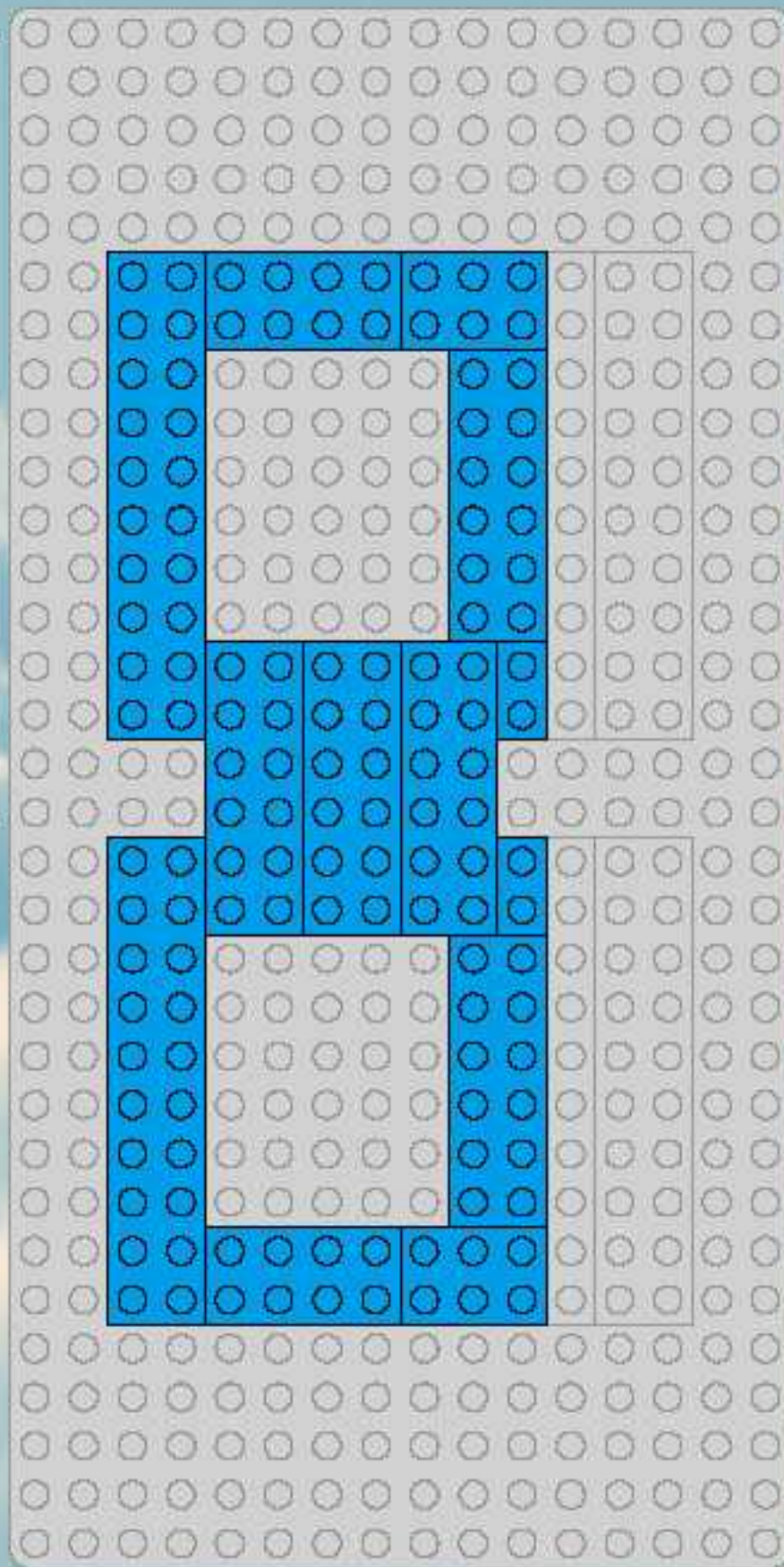
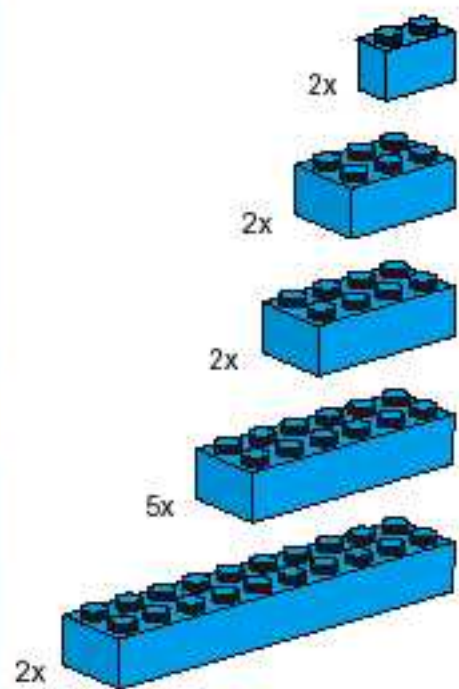

13

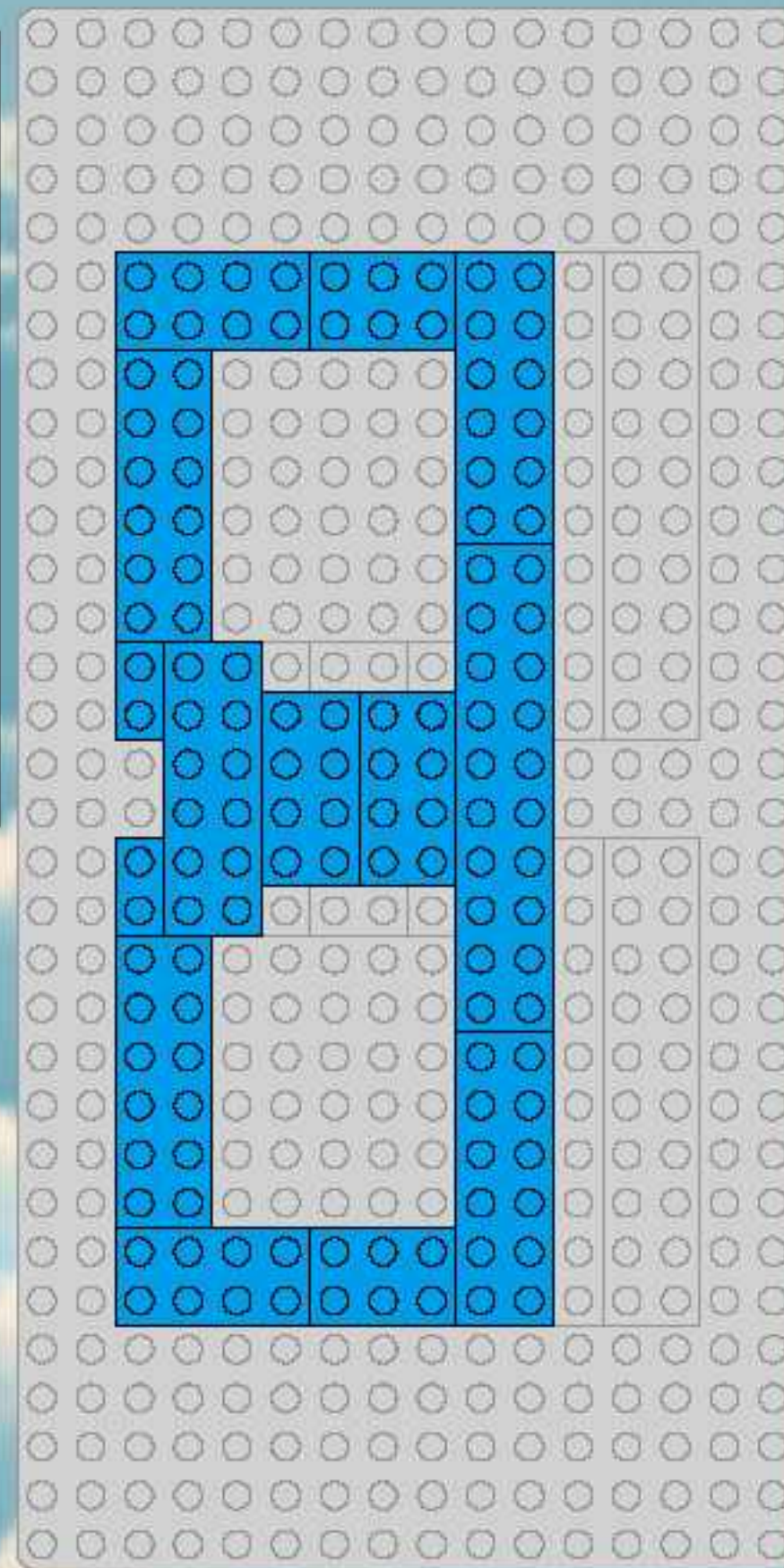
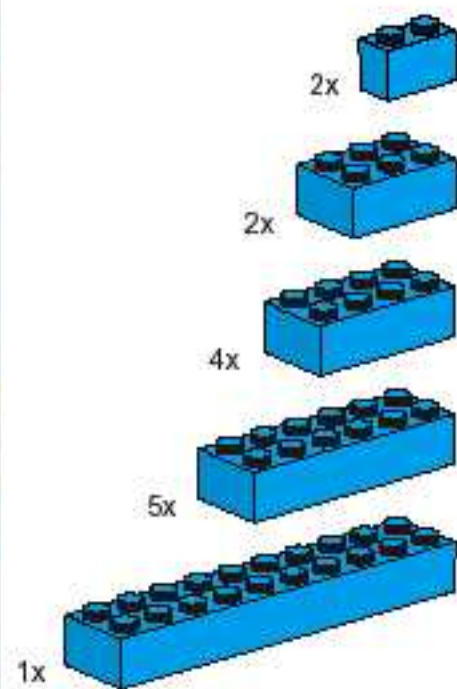

14

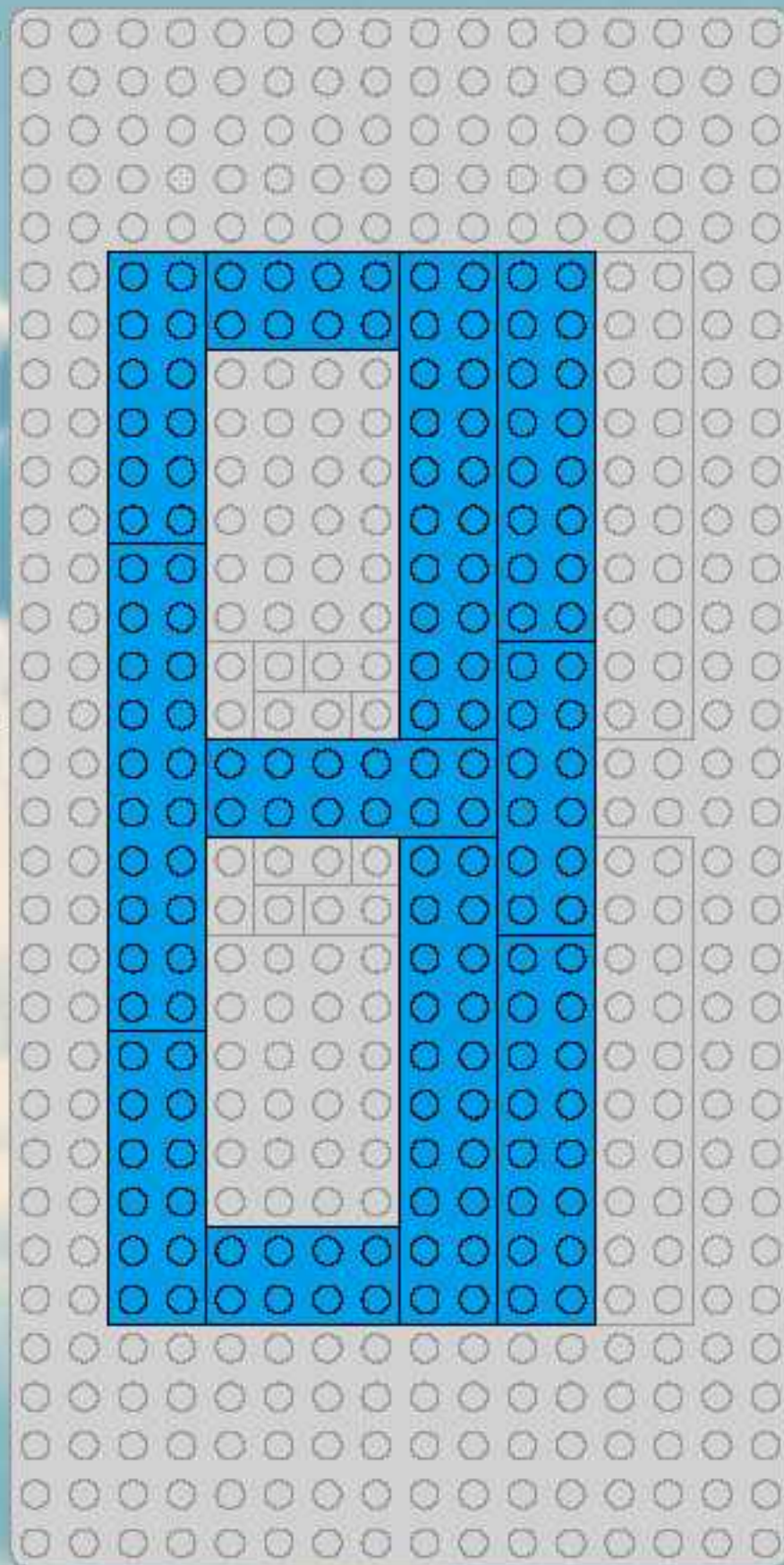
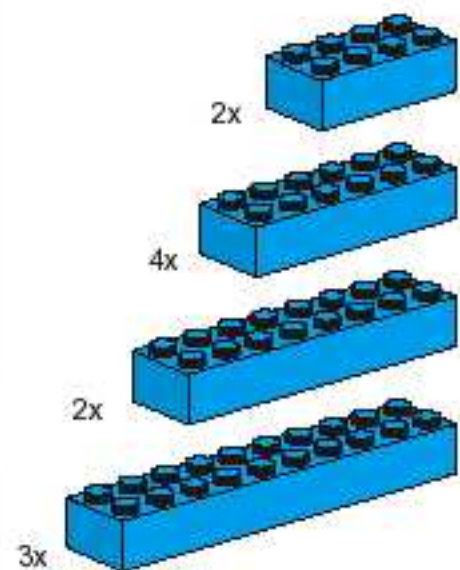

15

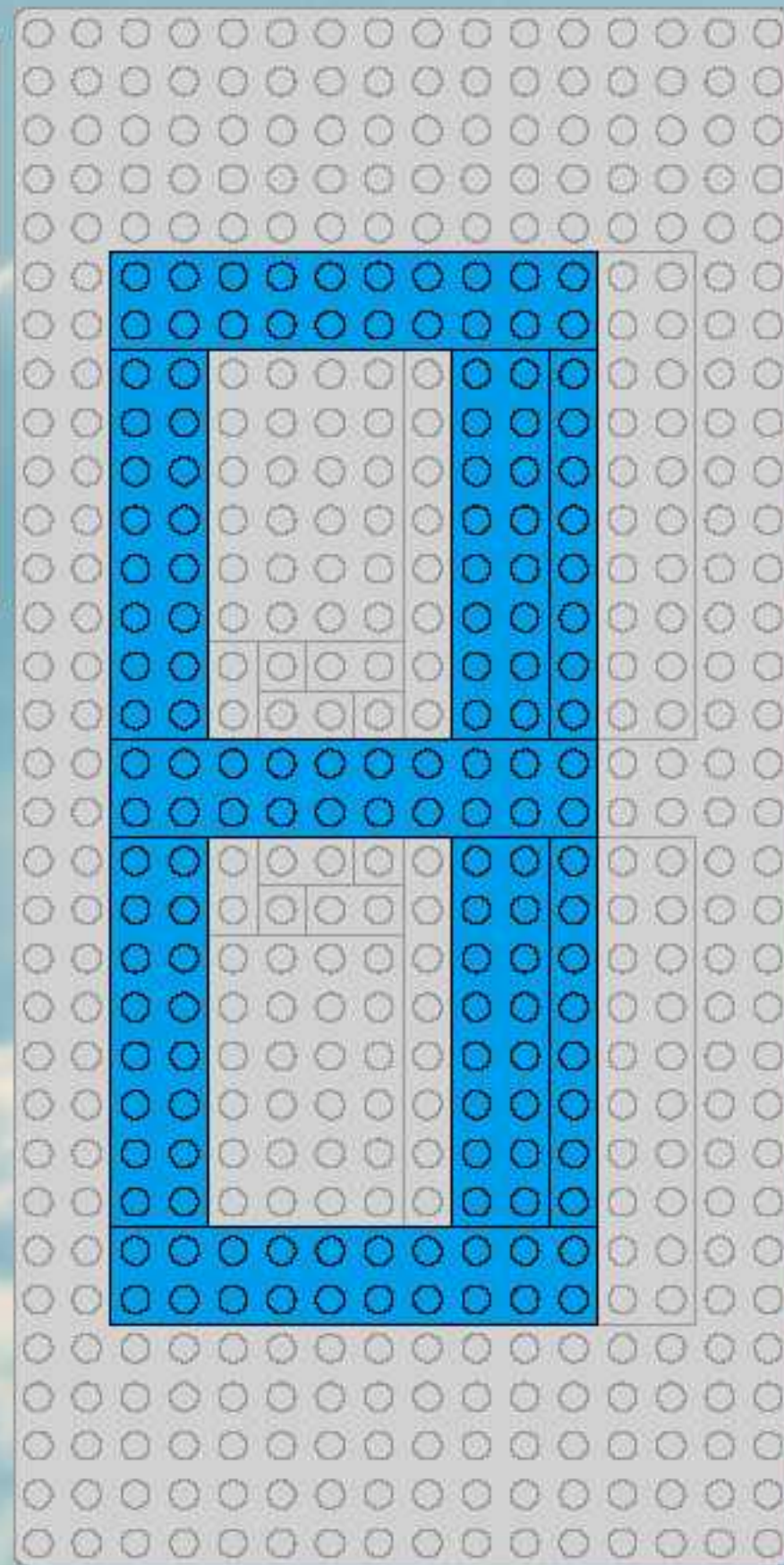
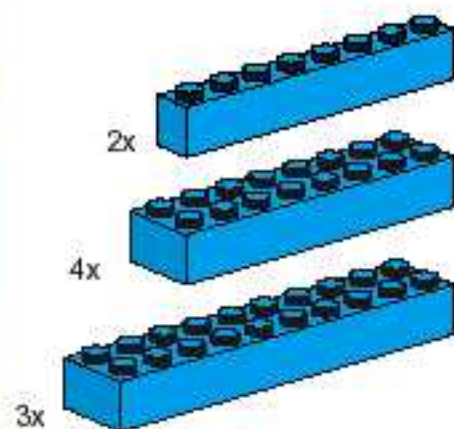

16

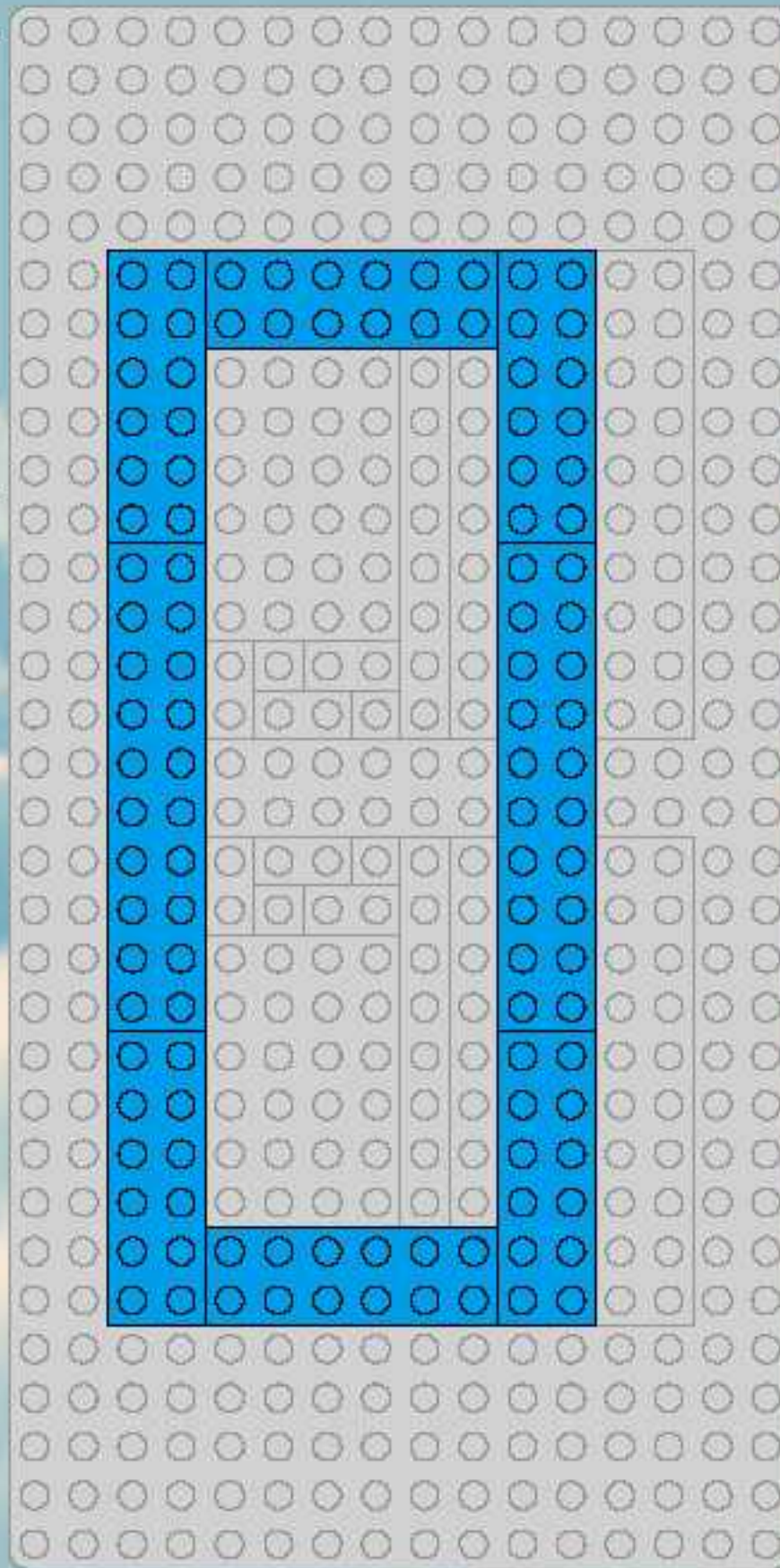
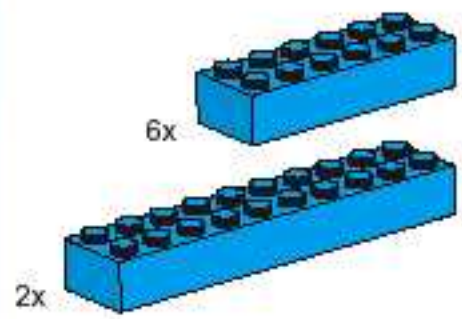

17

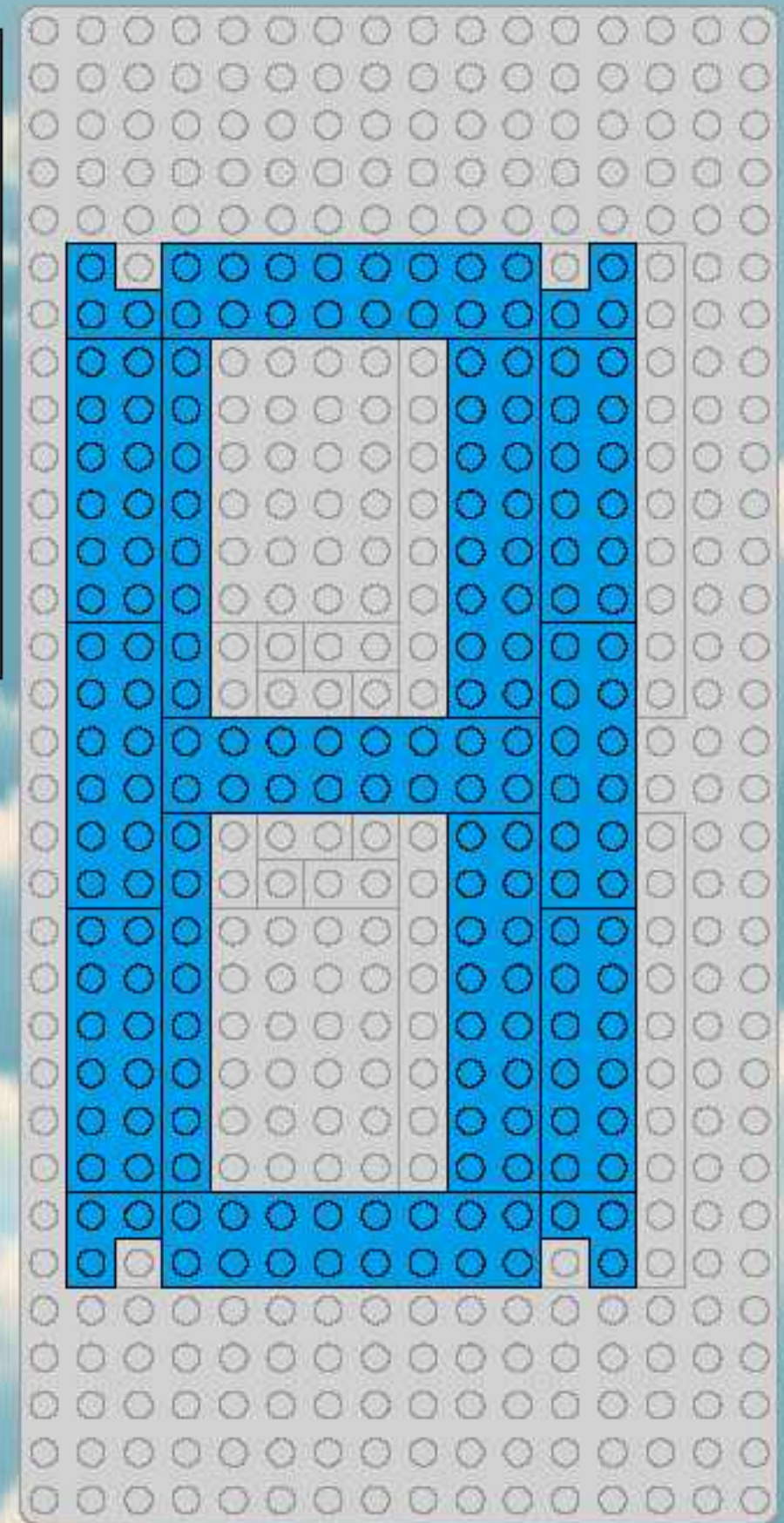
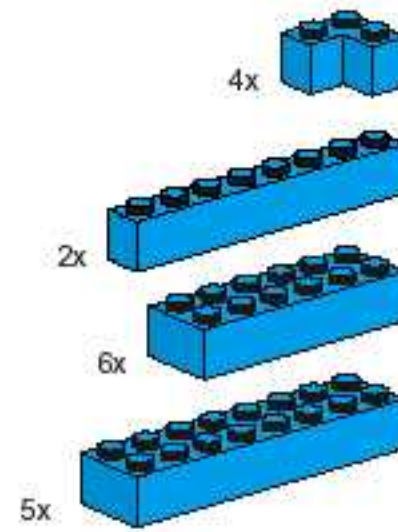

18

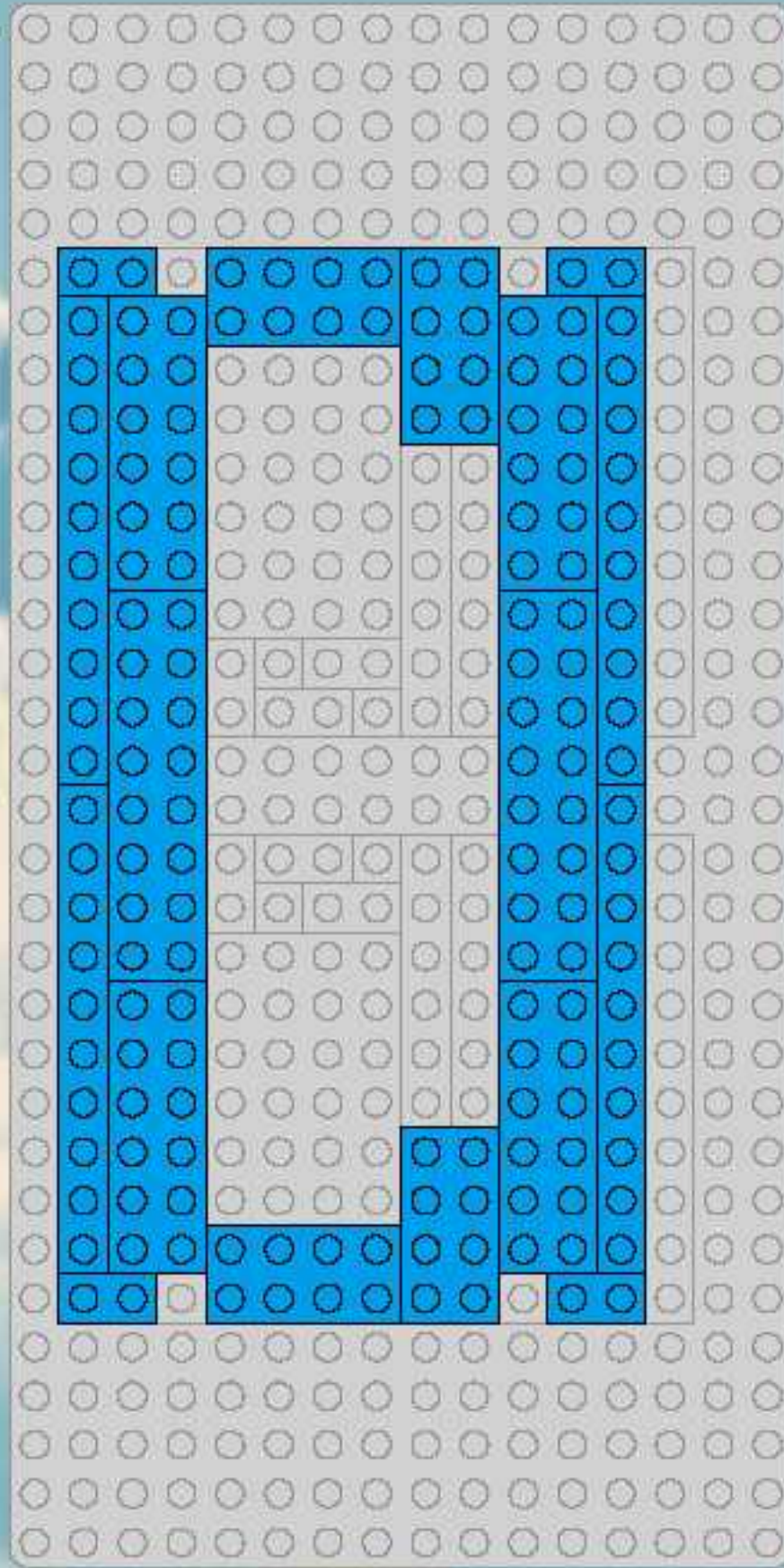
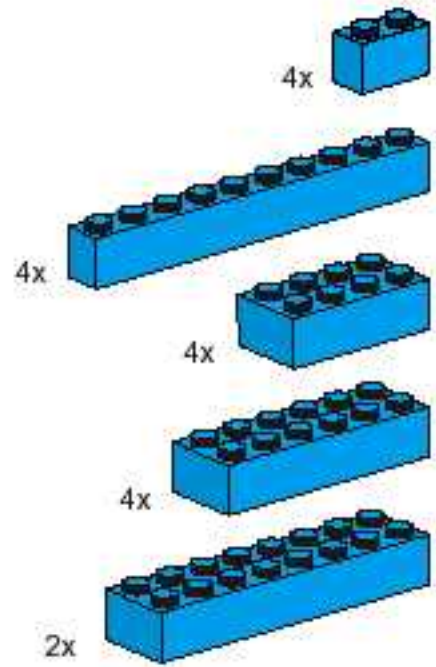

19

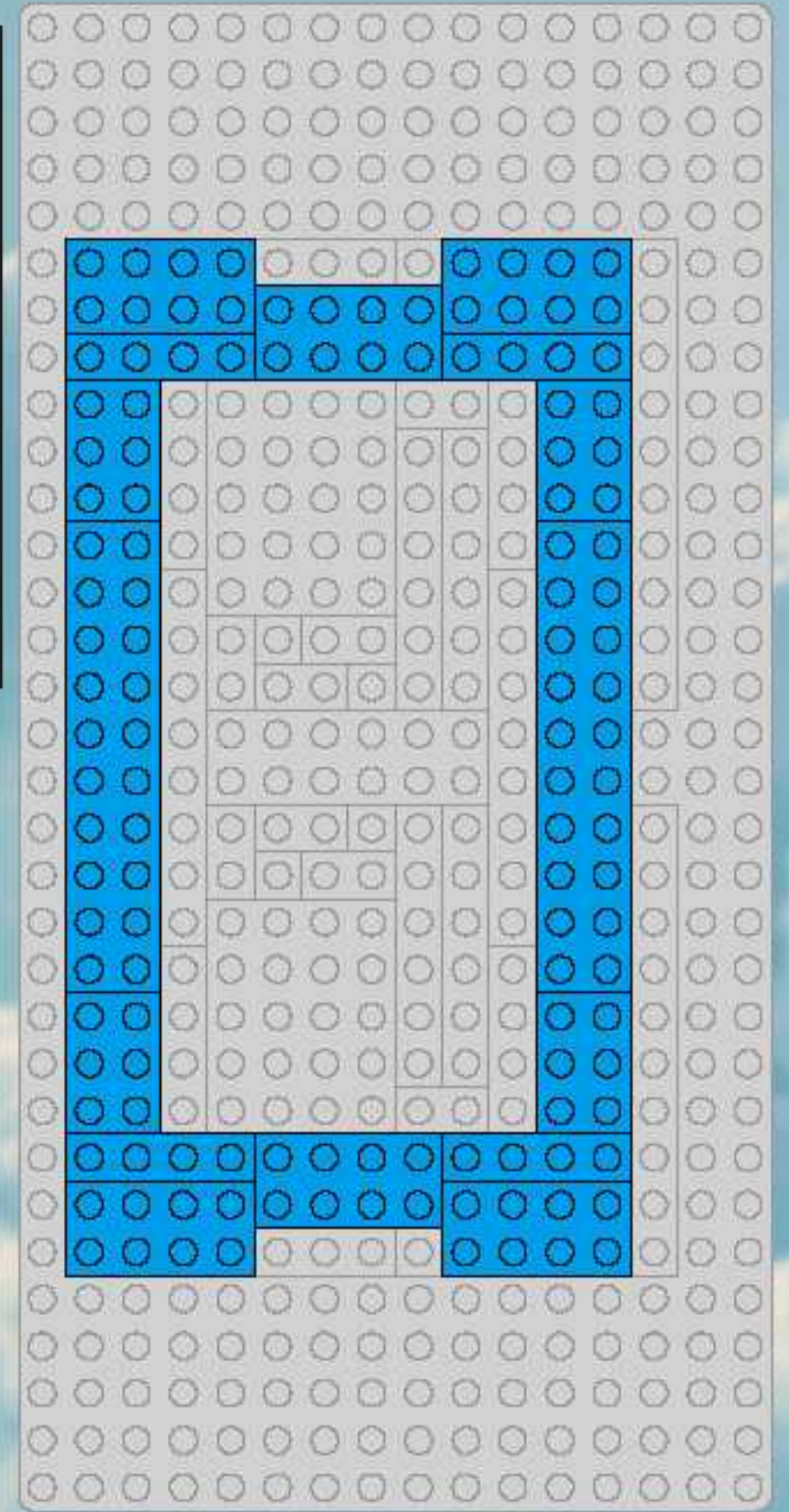
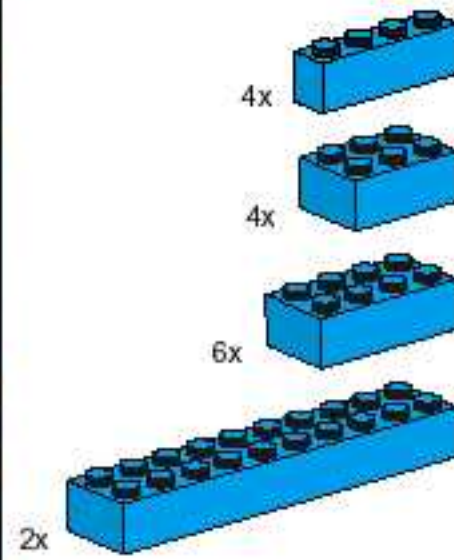

20

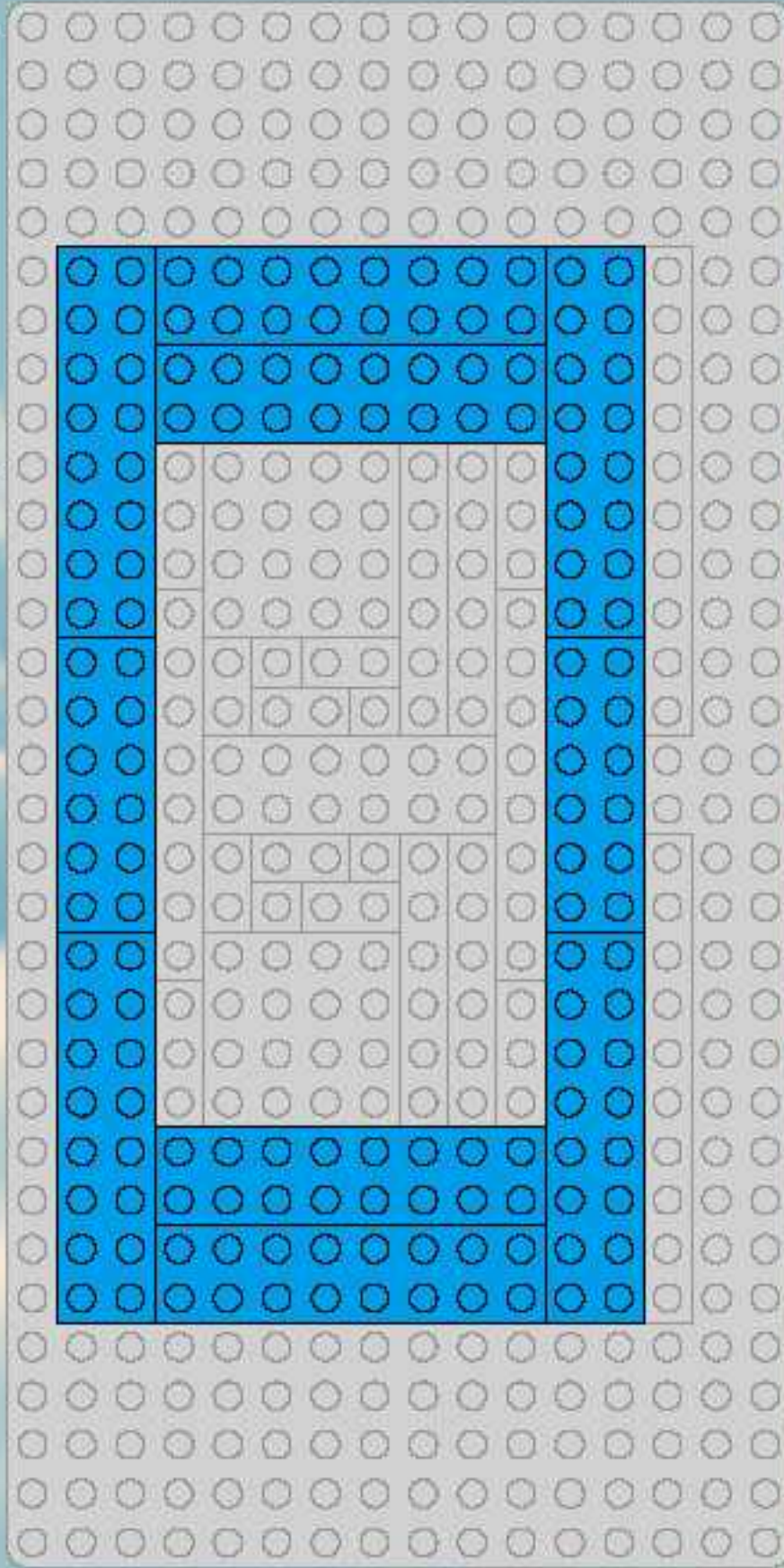

21

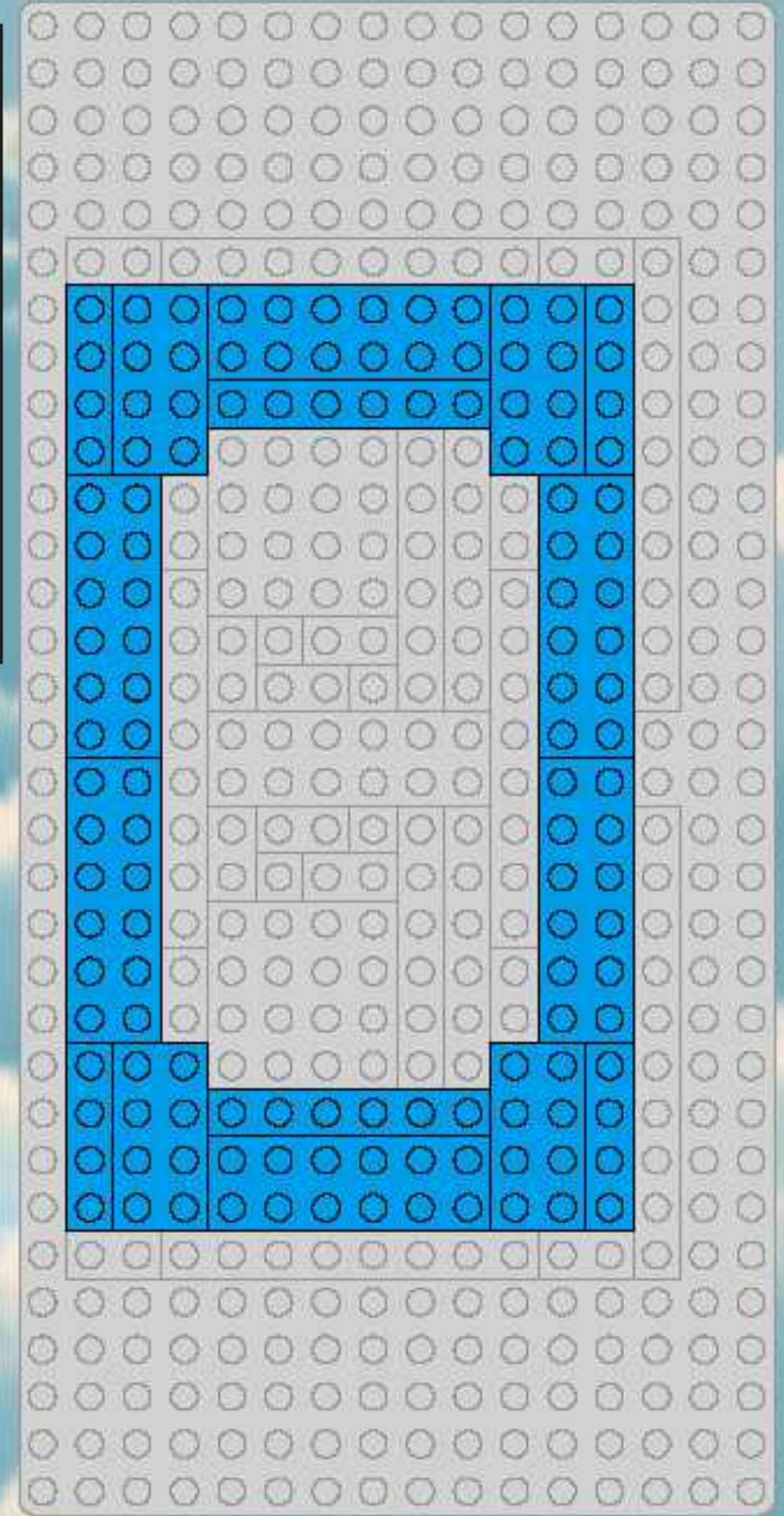

22

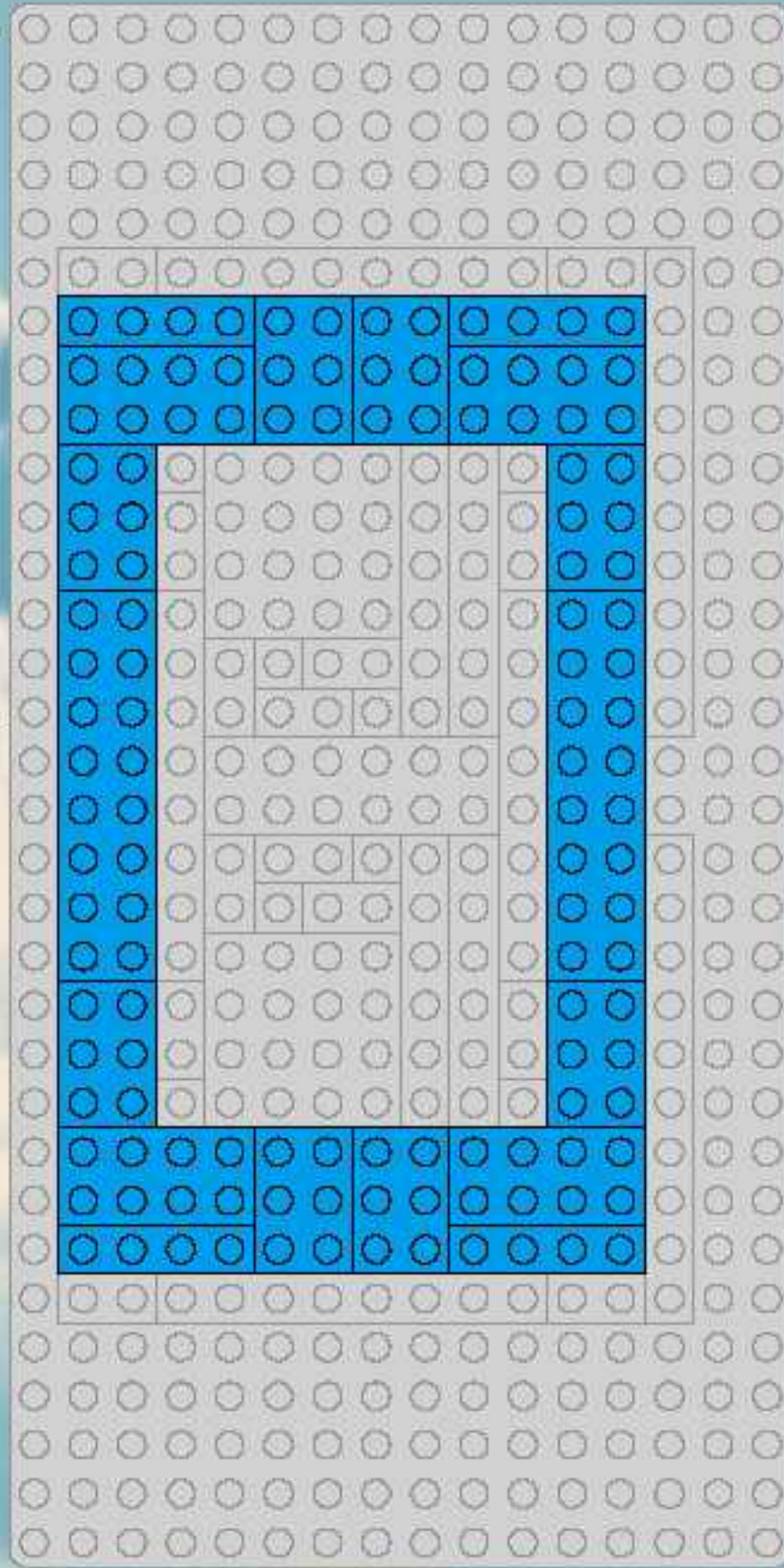
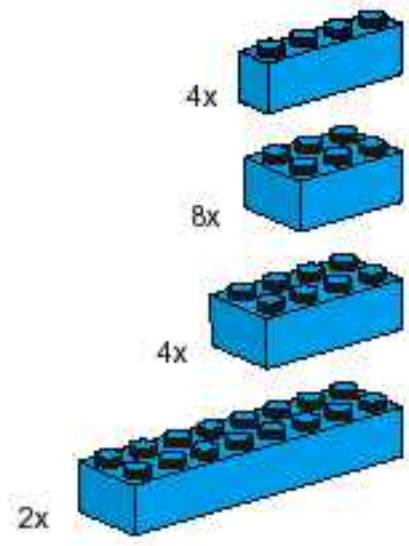

23

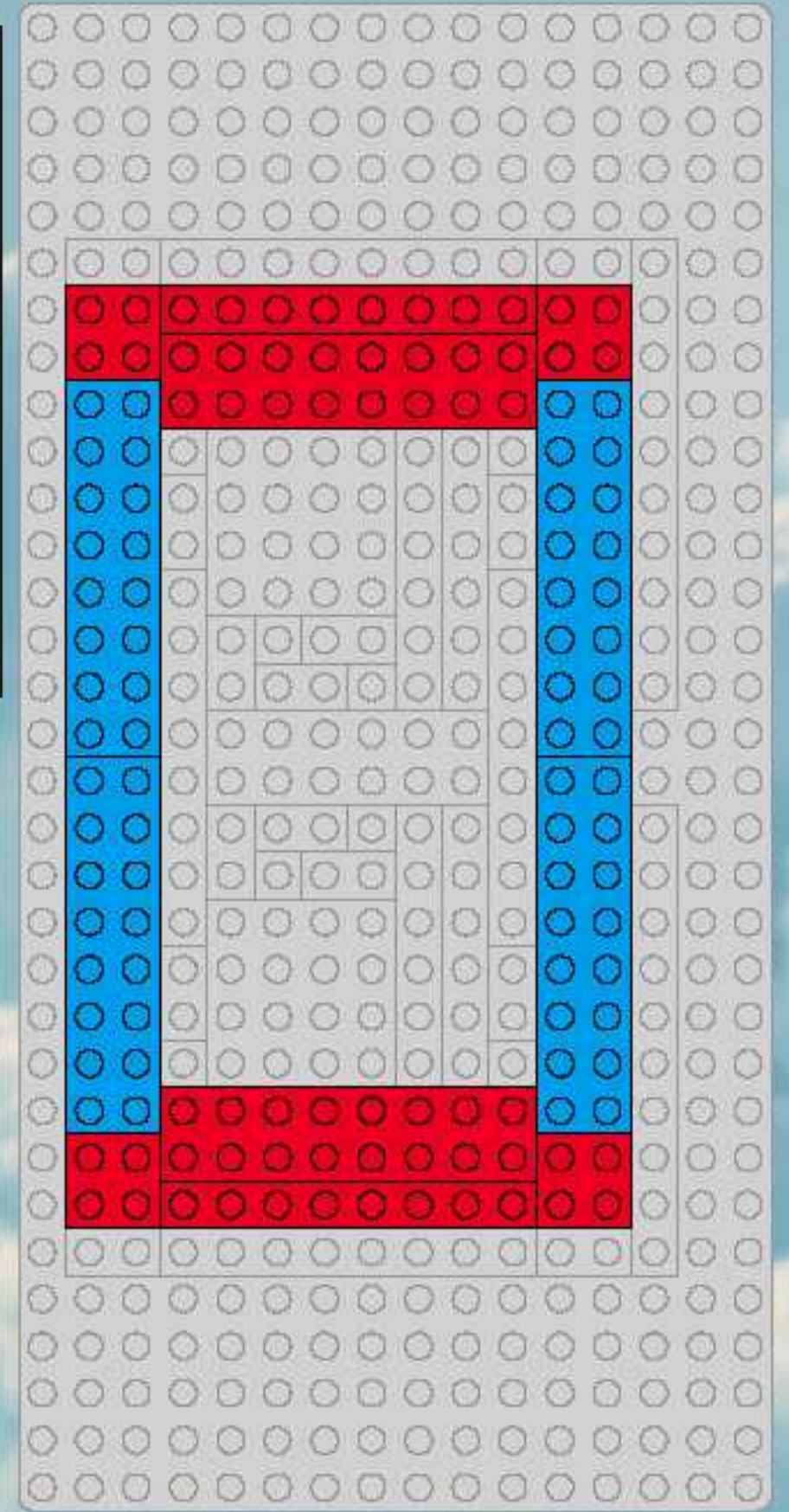
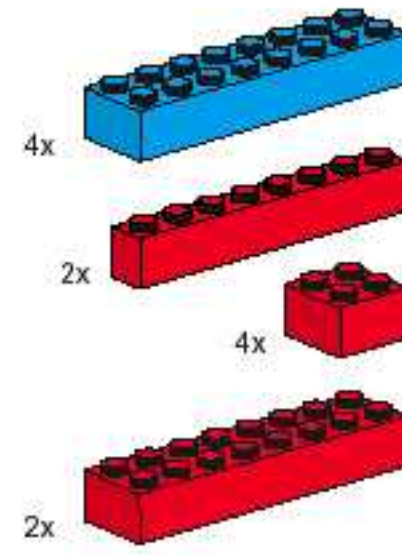

24

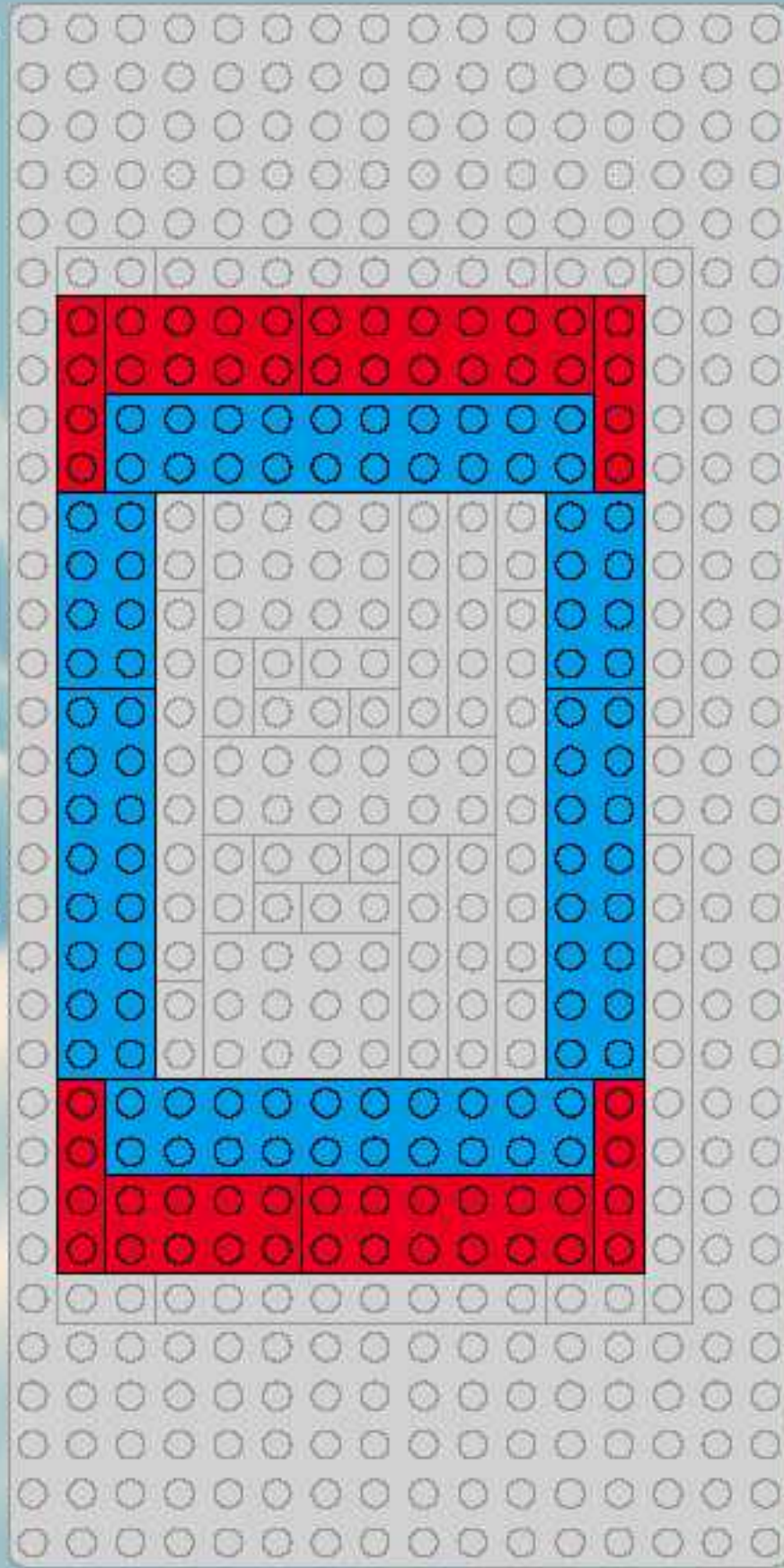
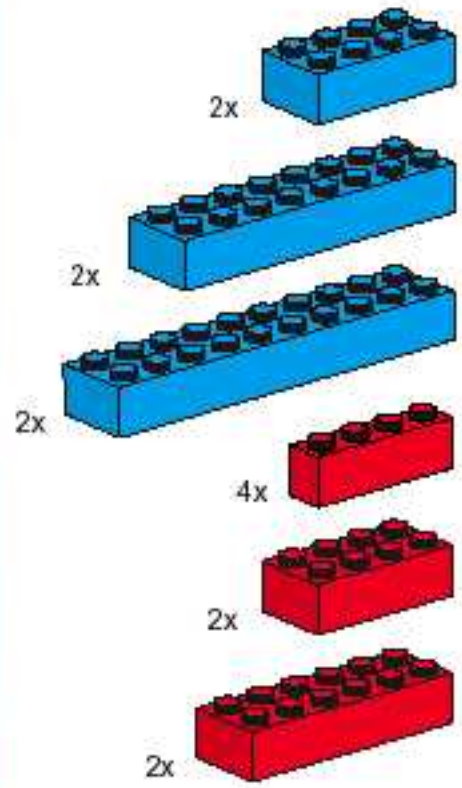

25

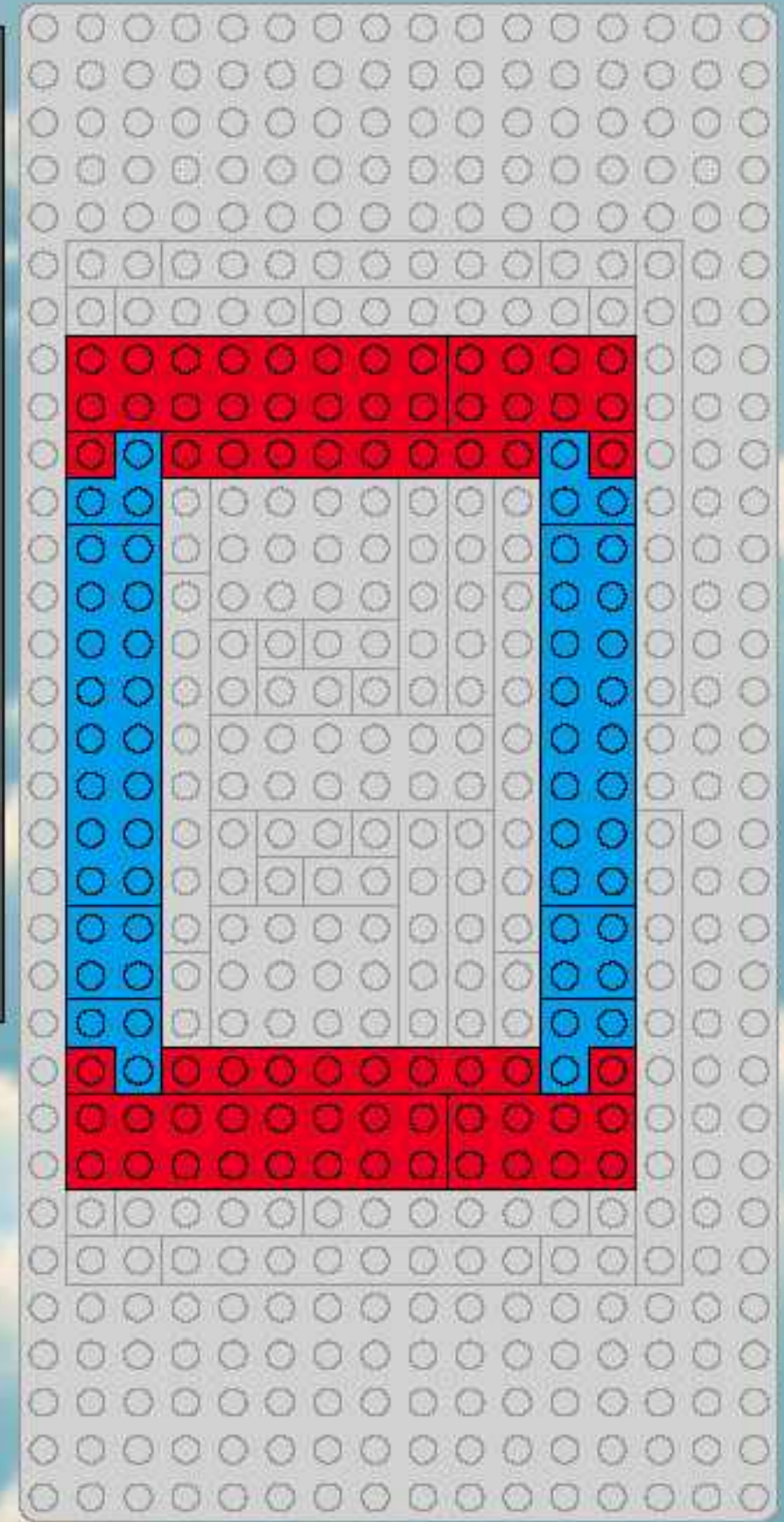
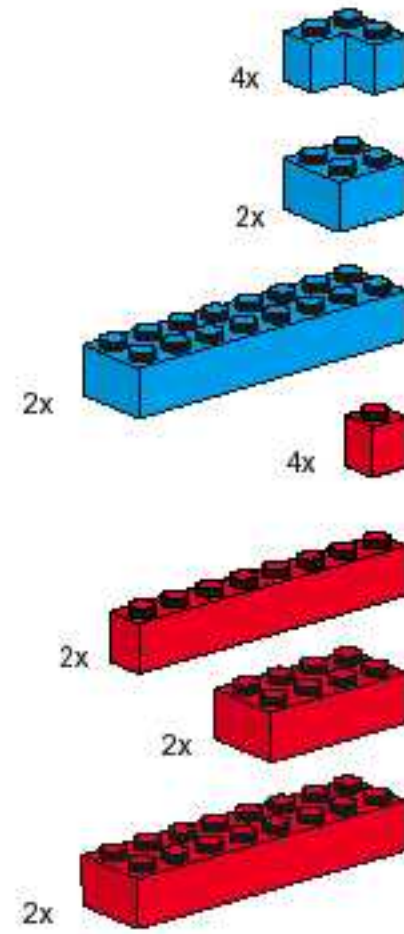

26

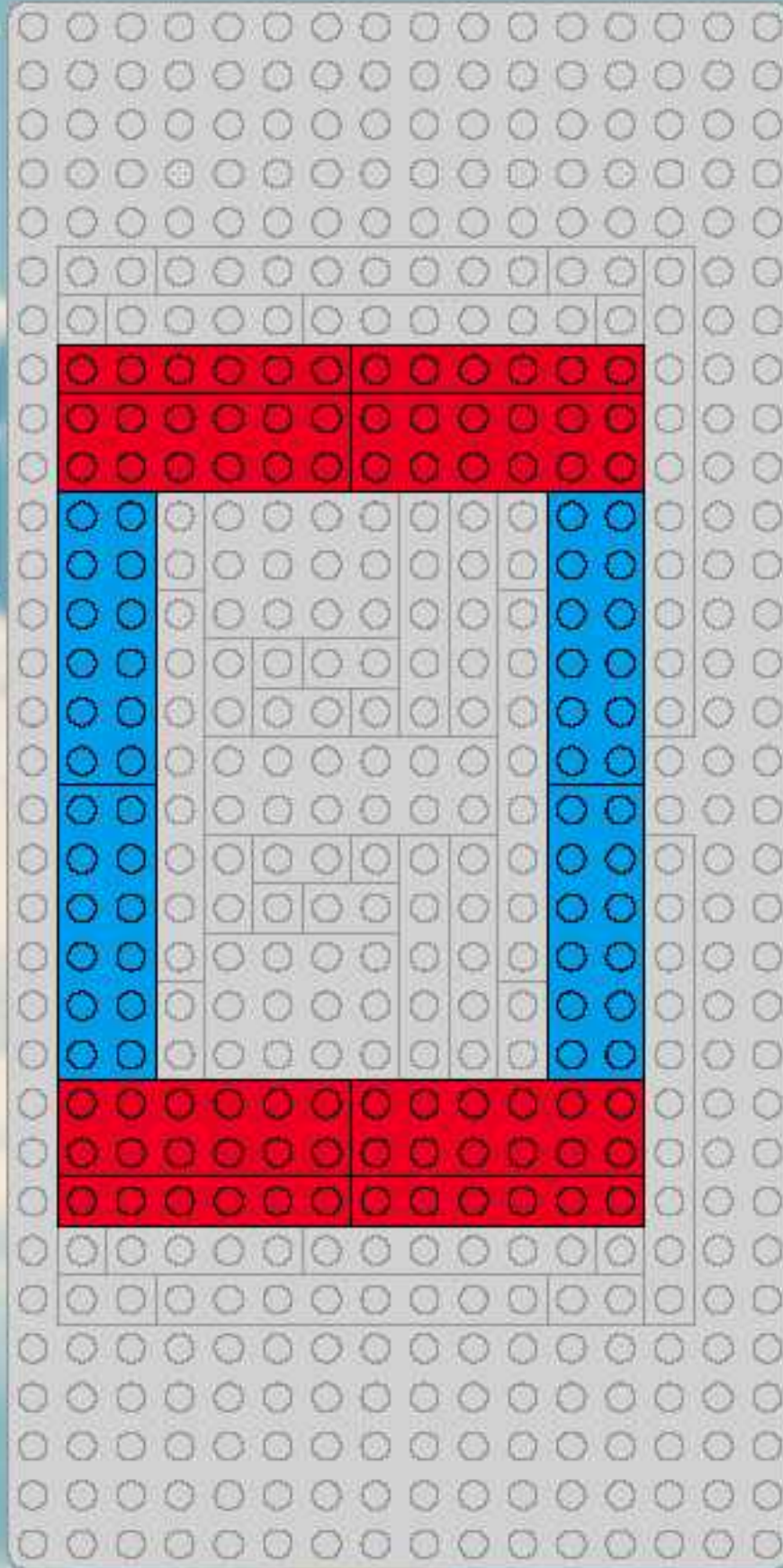
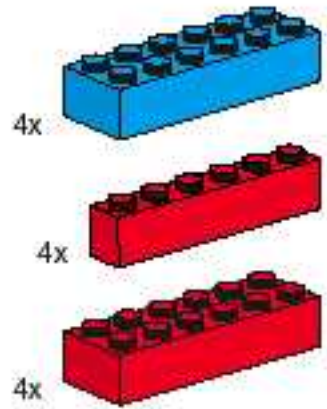

27

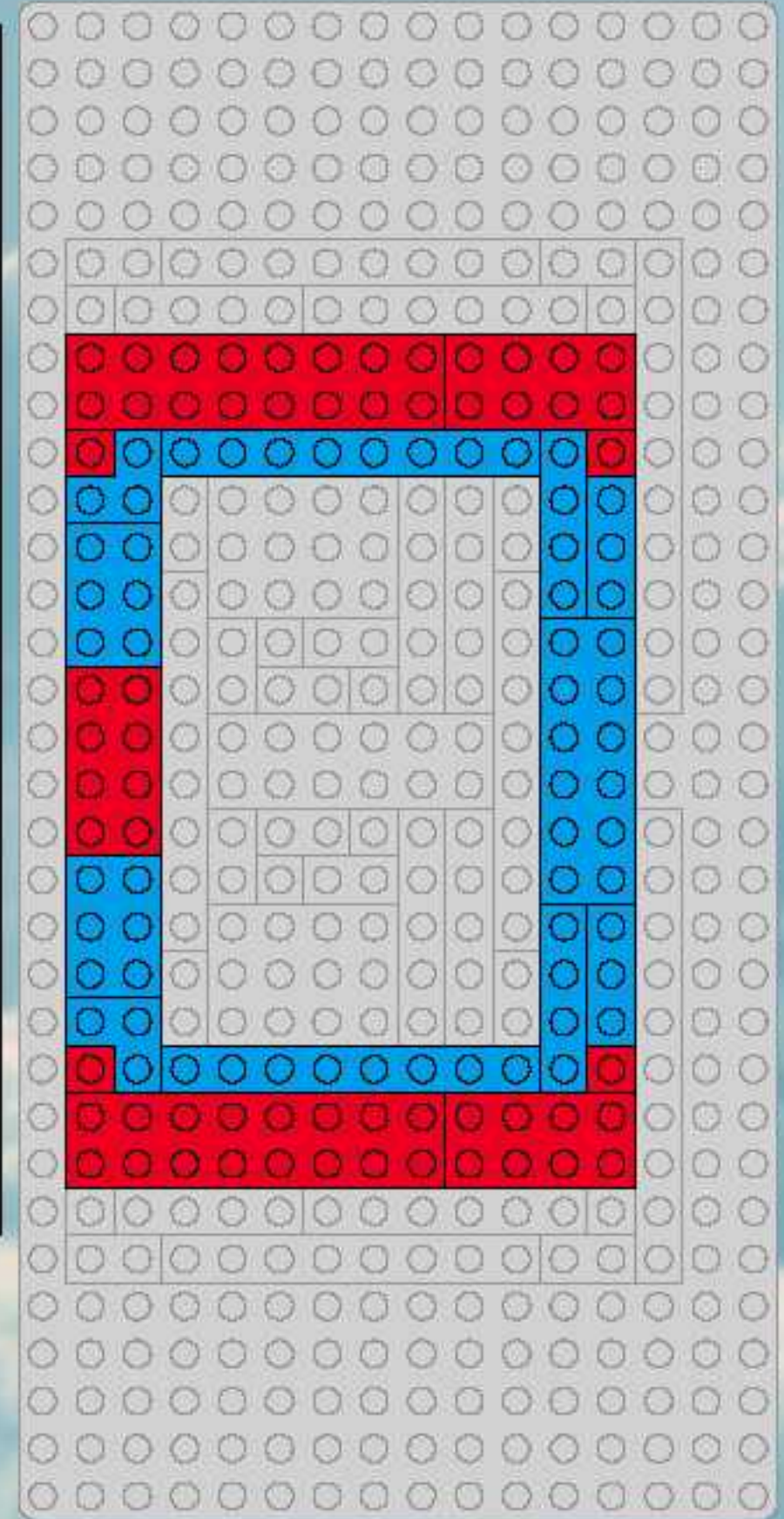
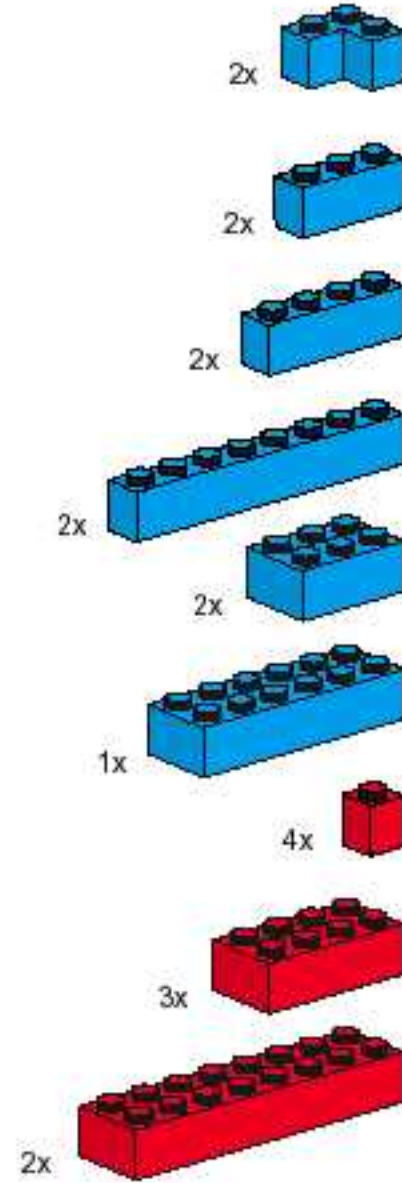

28

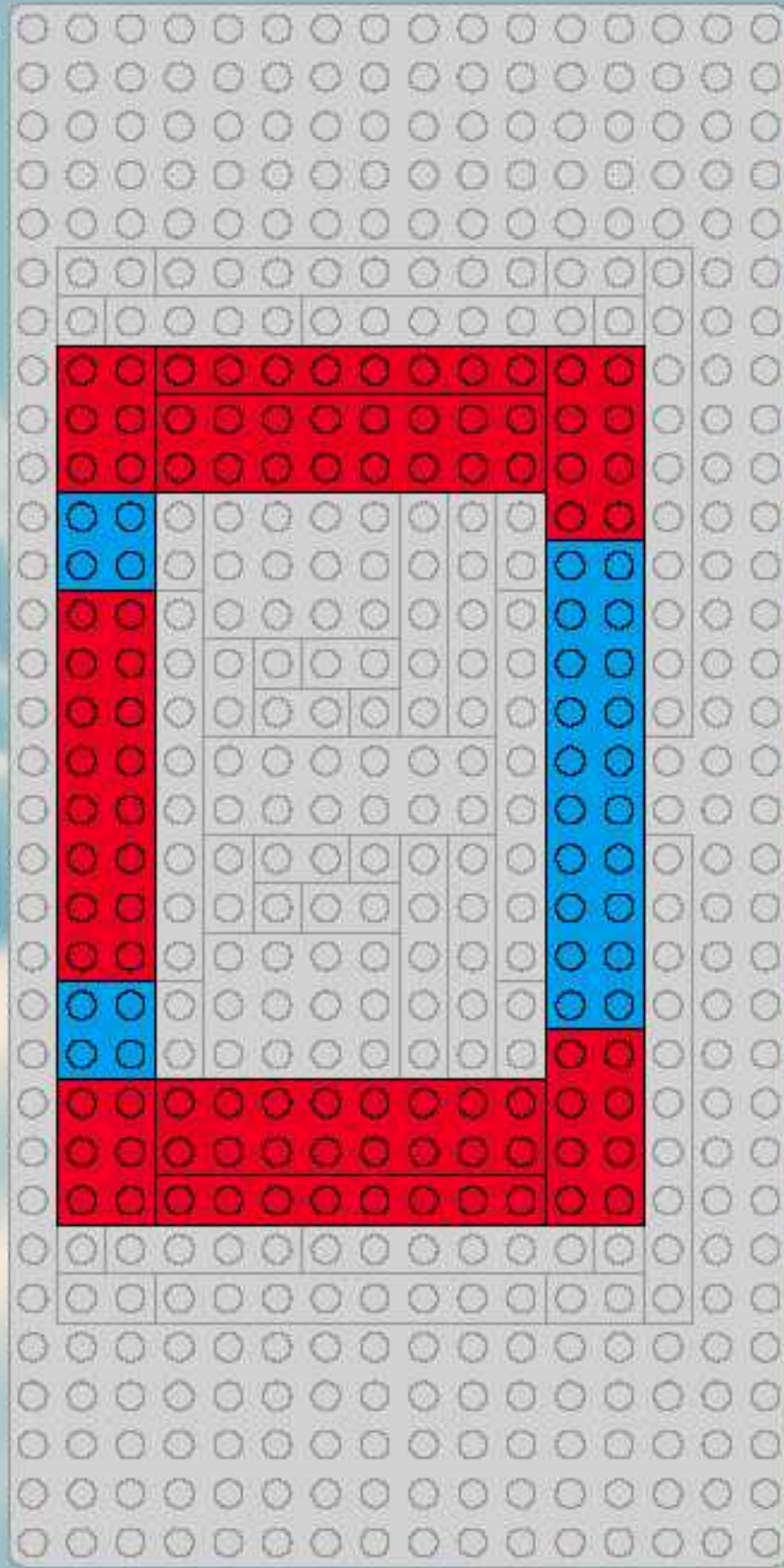
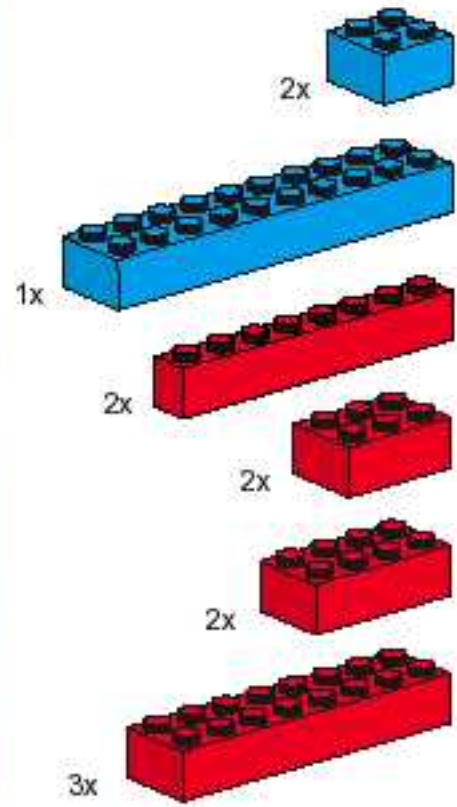

29

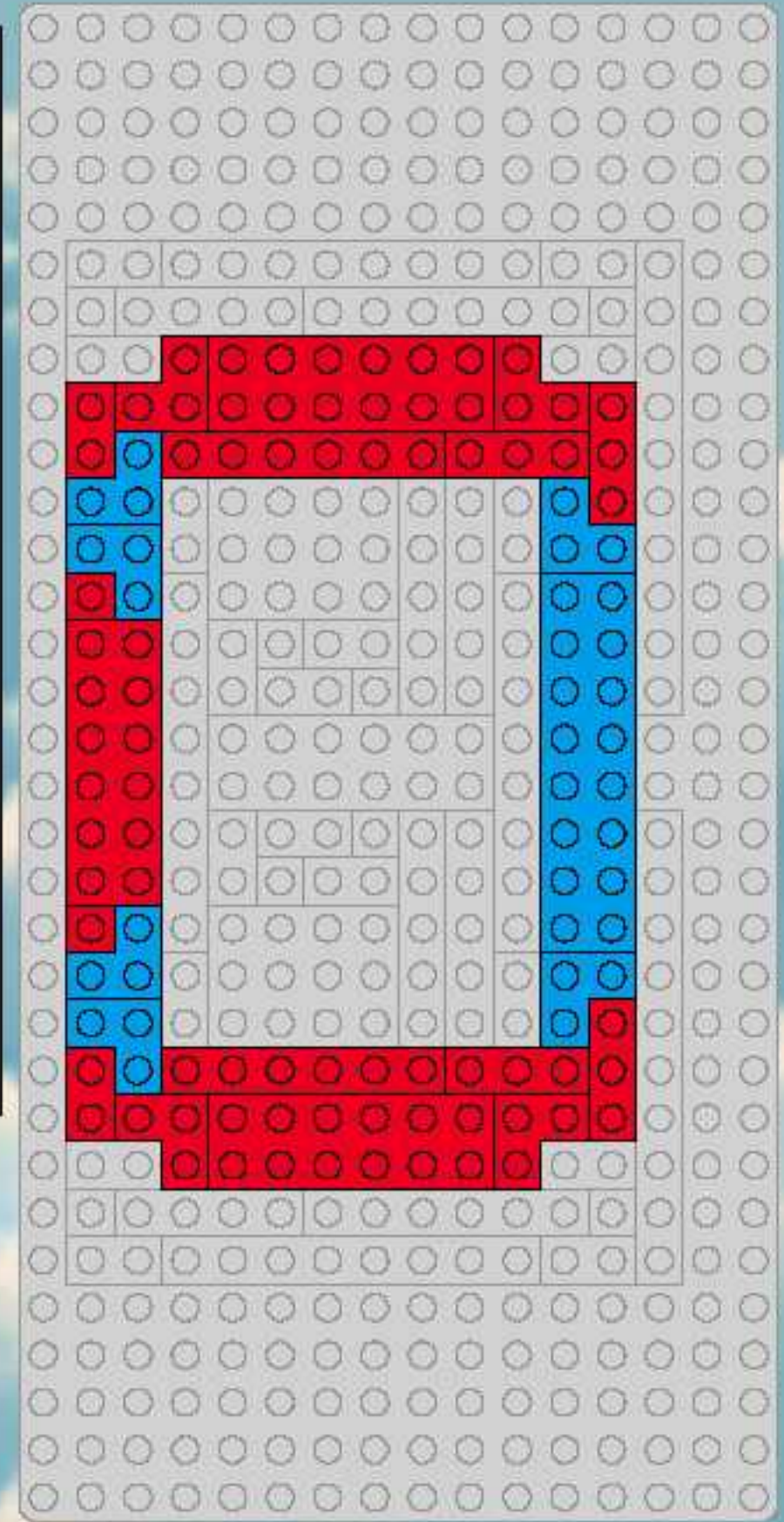
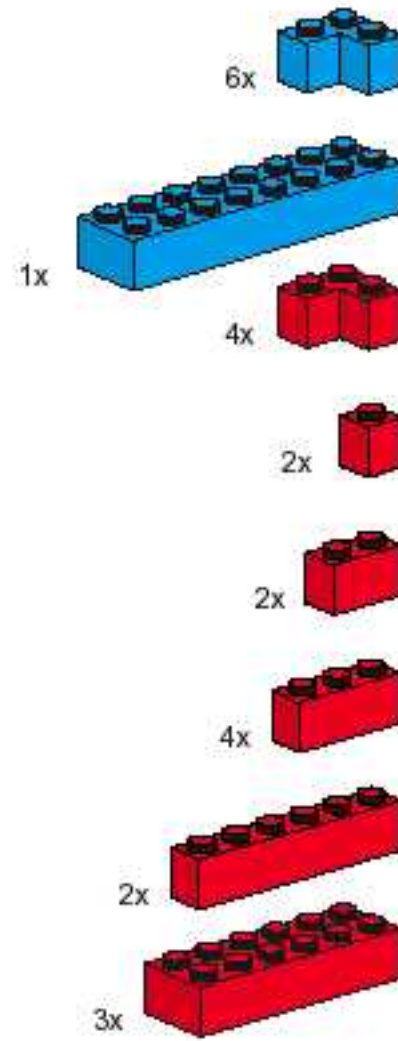

30

- 2x
- 2x
- 4x
- 2x
- 3x
- 2x
- 1x

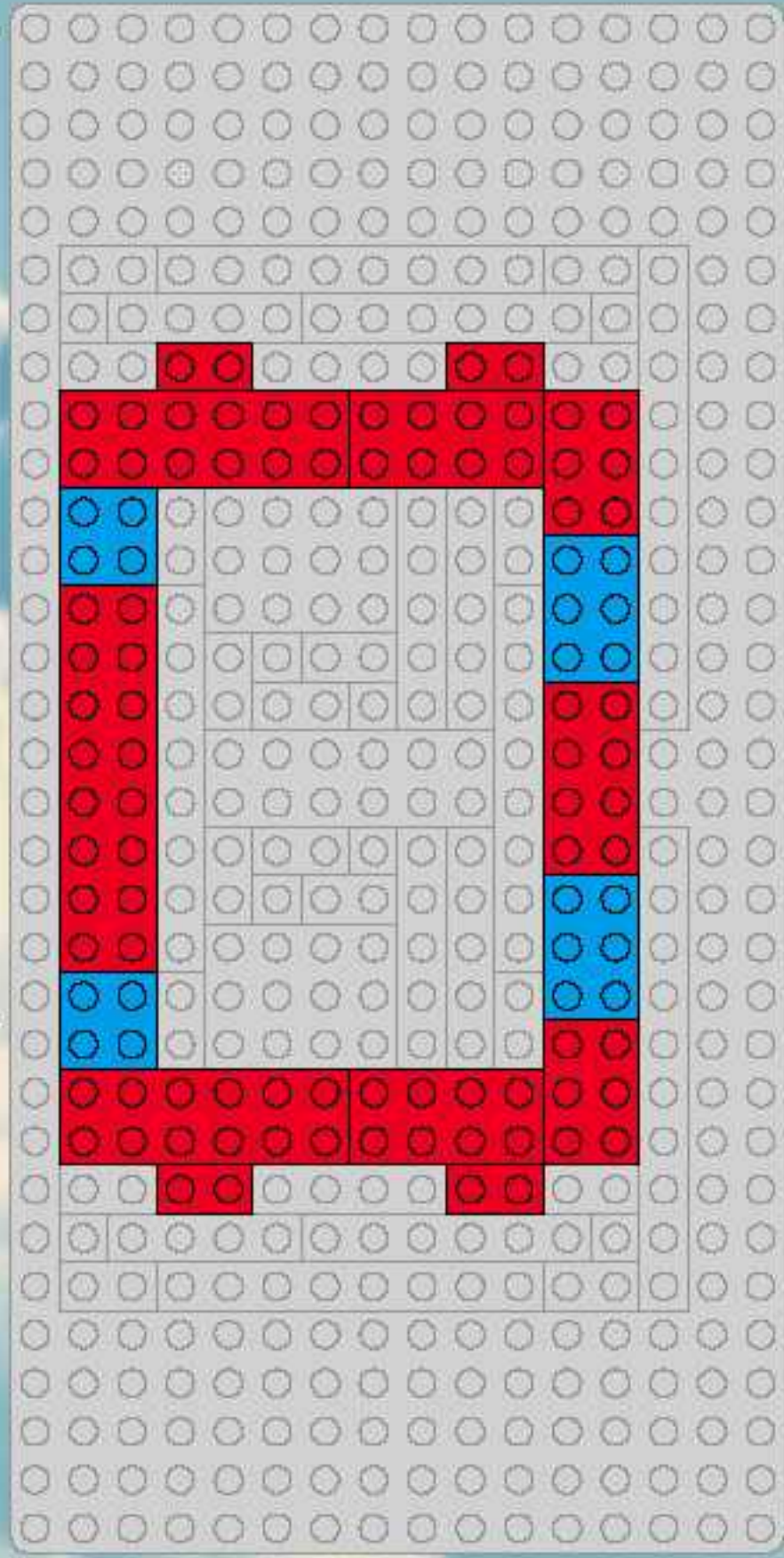

31

- 4x
- 2x
- 4x
- 8x
- 2x
- 4x
- 4x
- 1x
- 1x
- 2x
- 1x

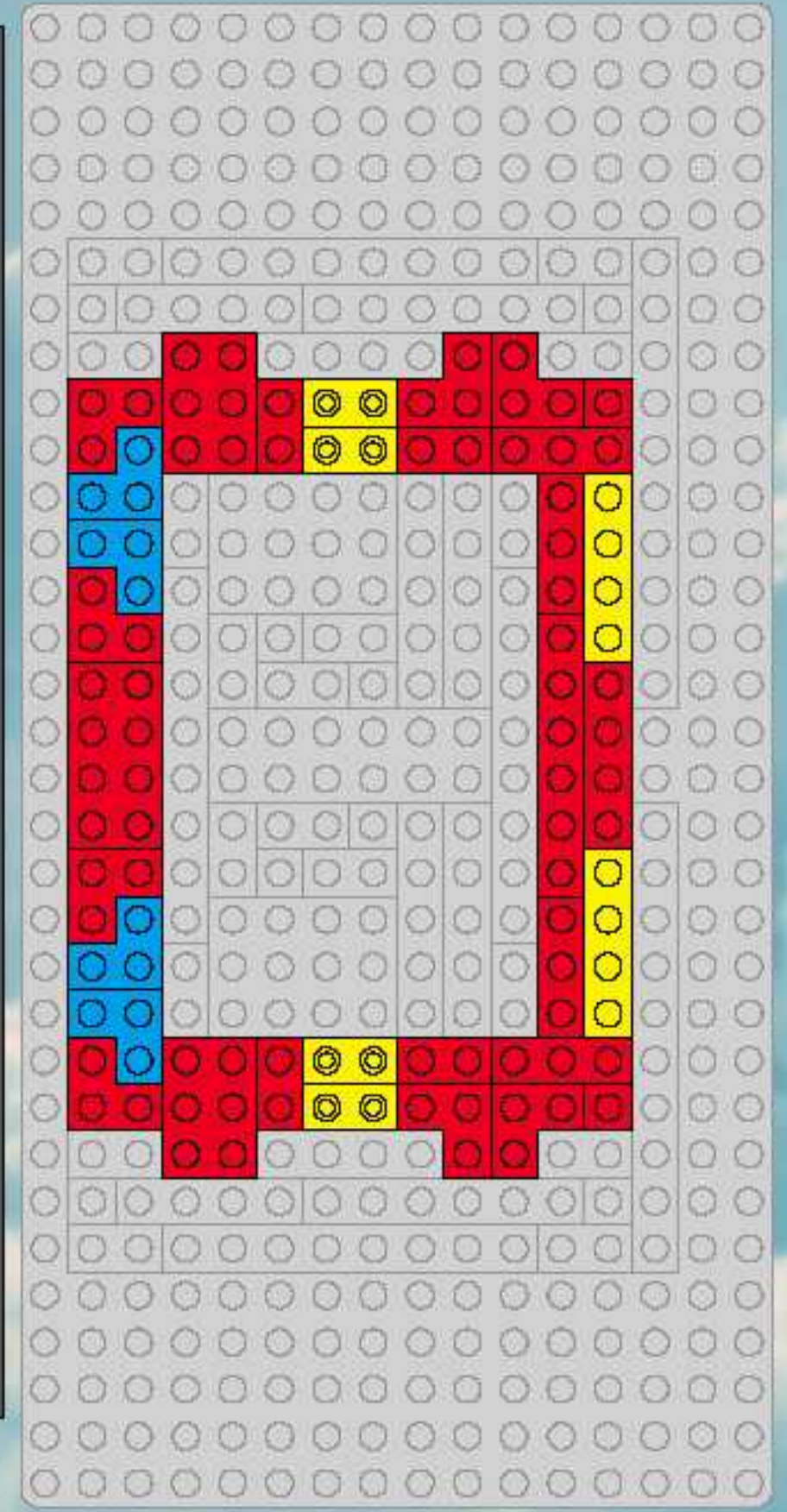

32

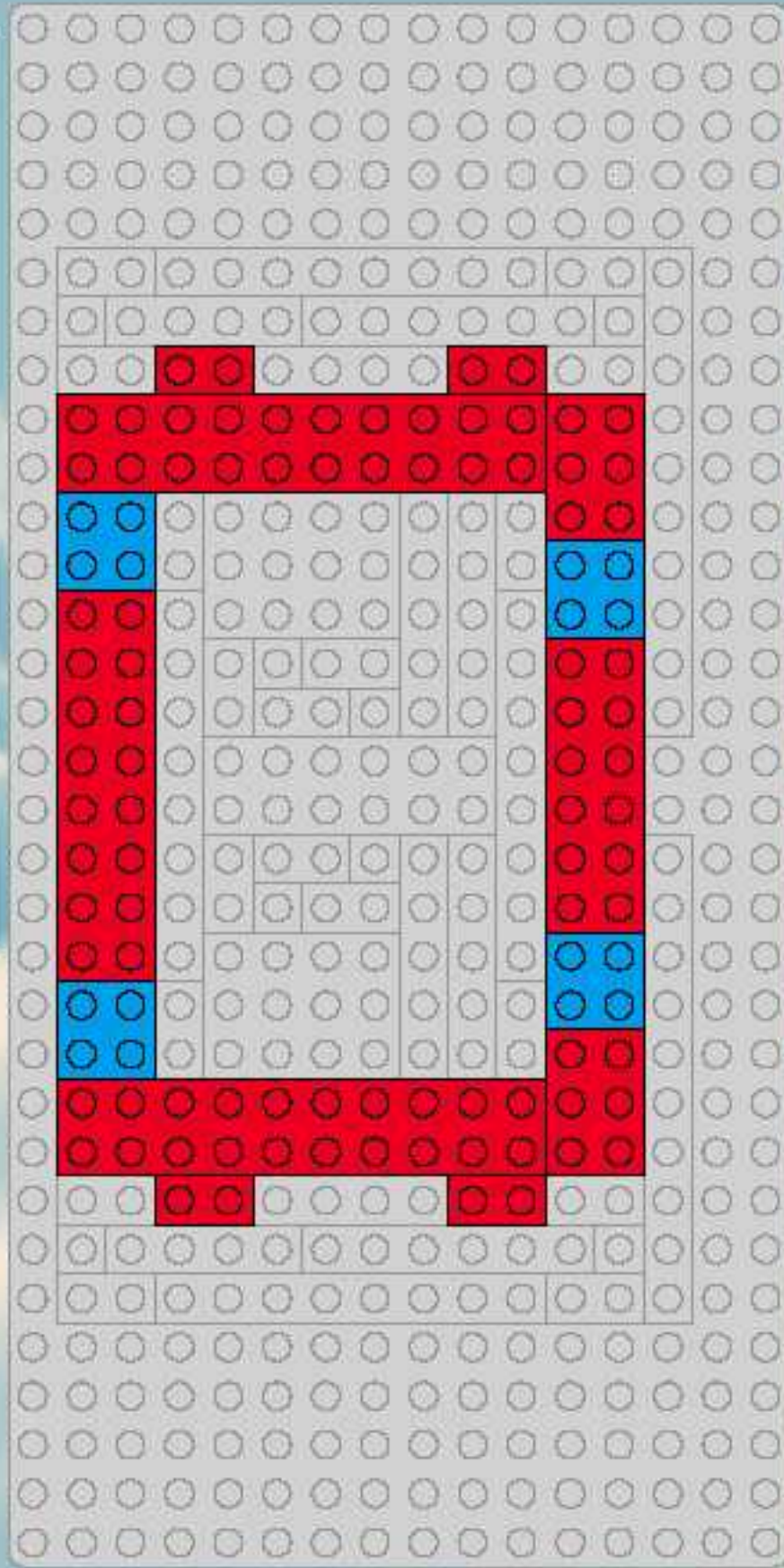
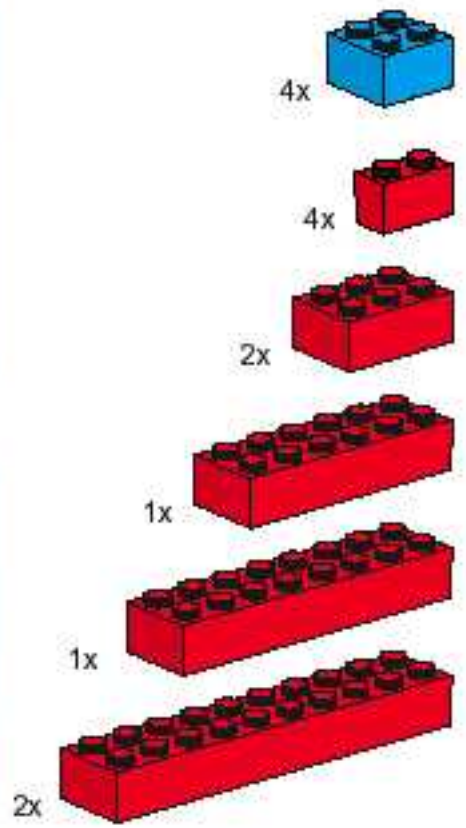

33

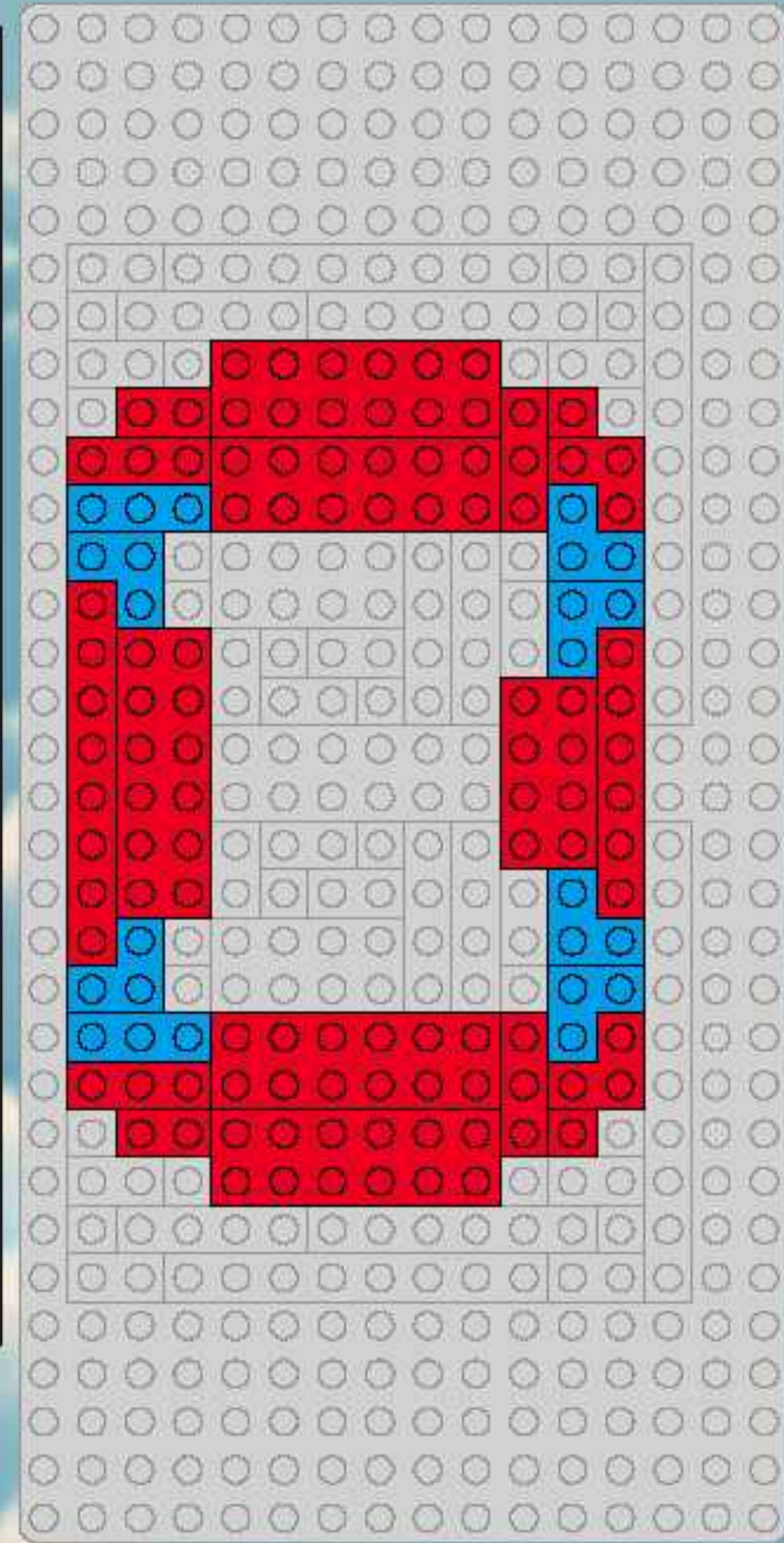
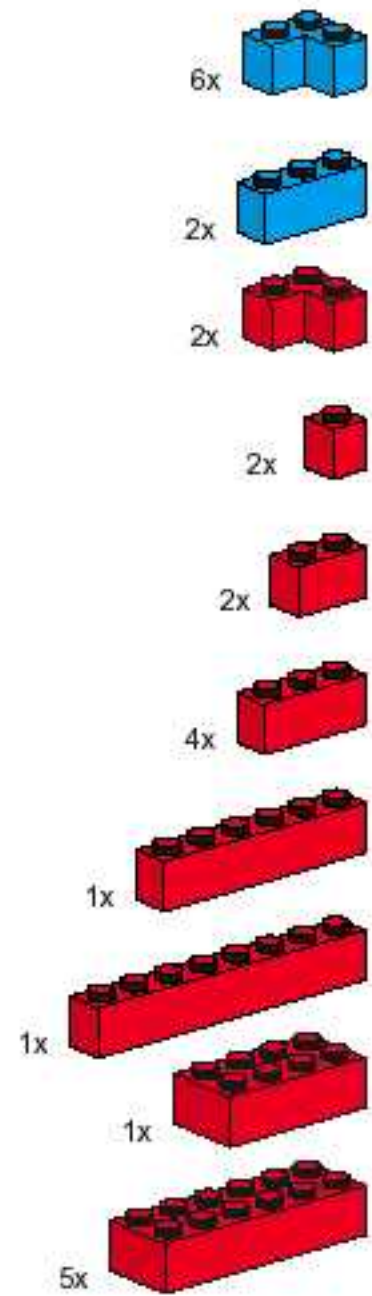

34

4x 

8x 

2x 

2x 

2x 

6x 

4x 

2x 

2x 

2x 

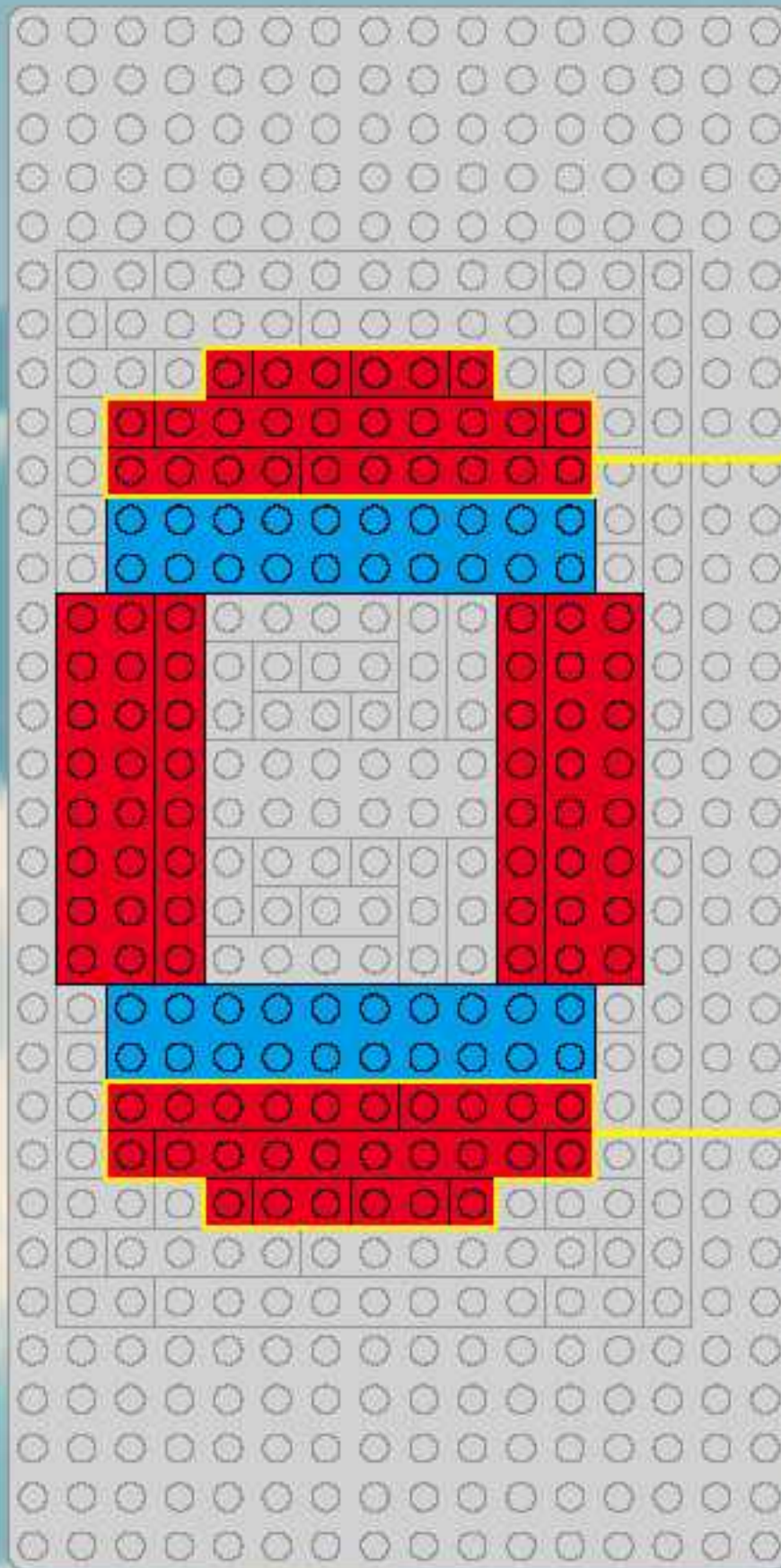

1

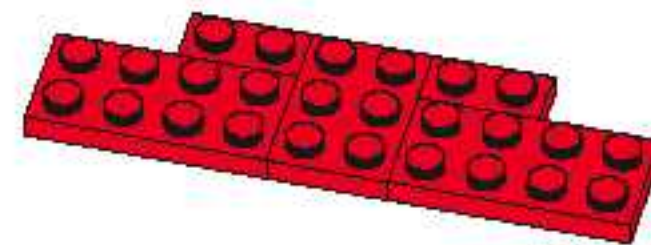

2

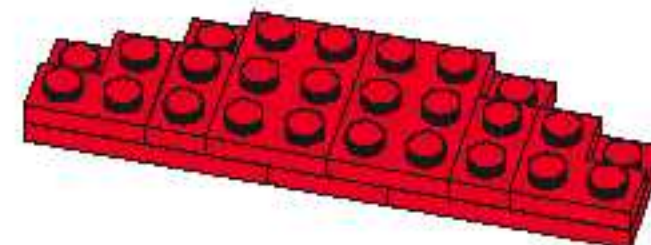

3

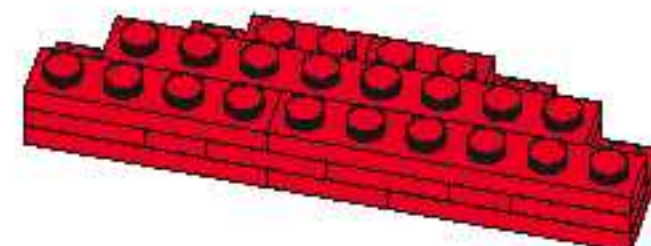

2x

35

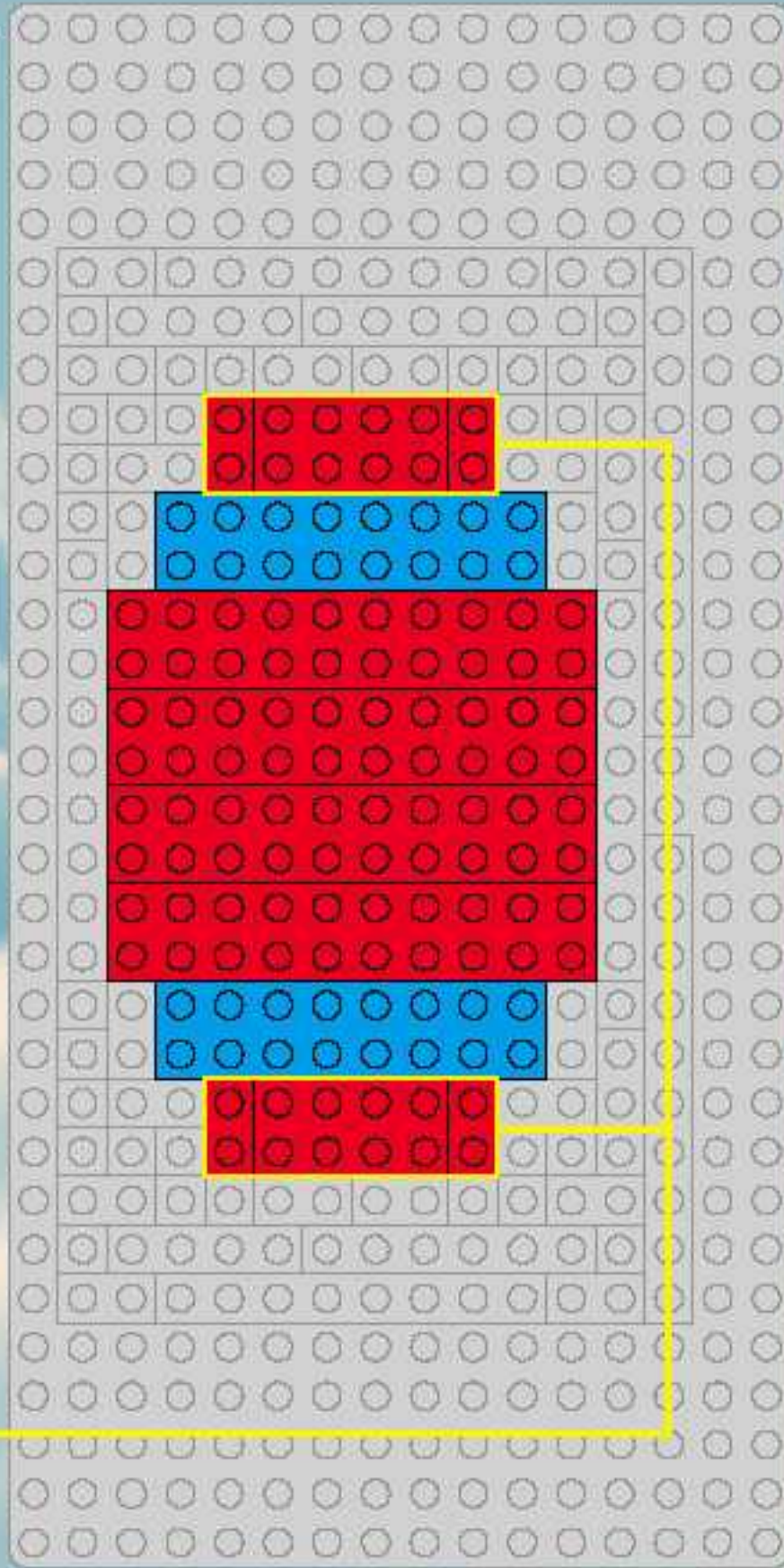
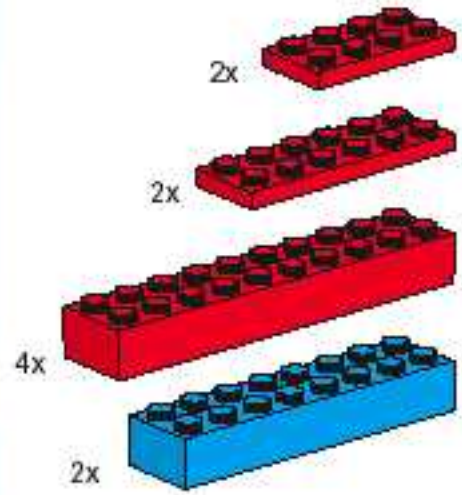

36

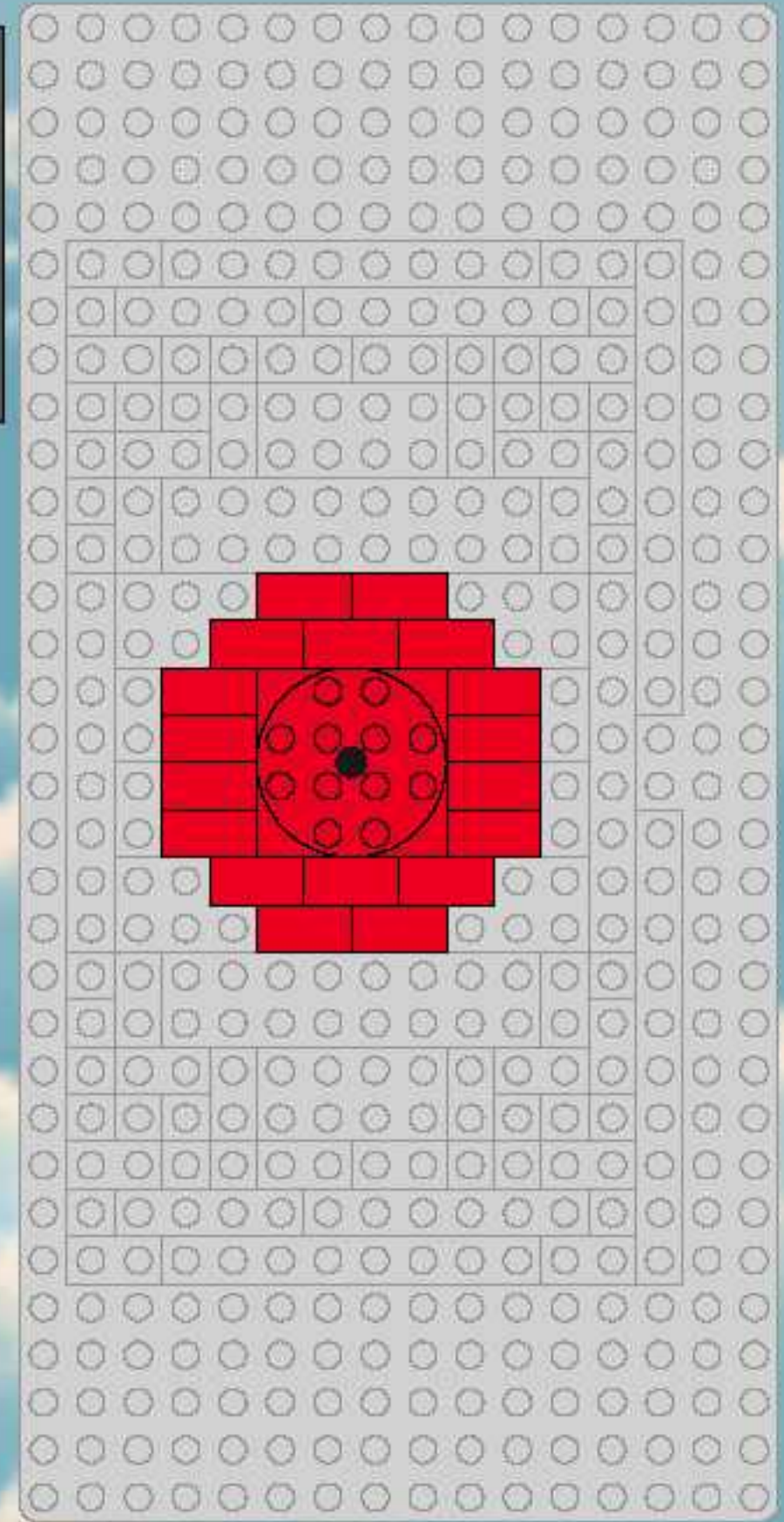
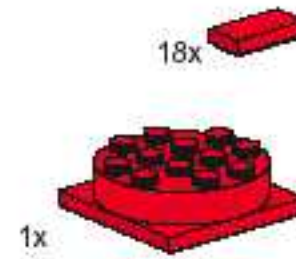

1

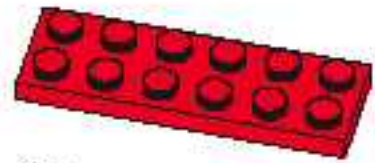

2

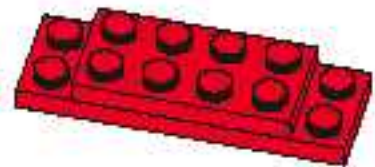

2x



1

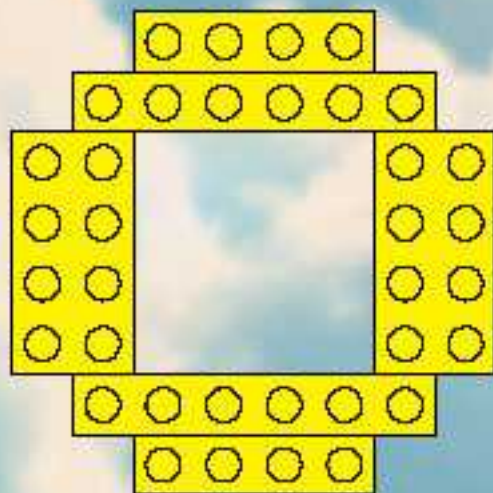
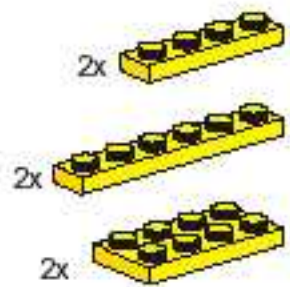

2

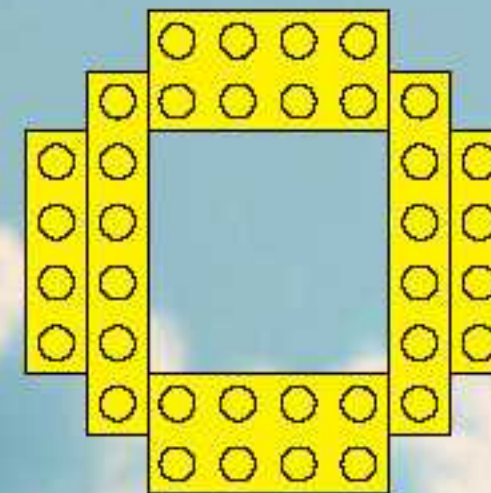
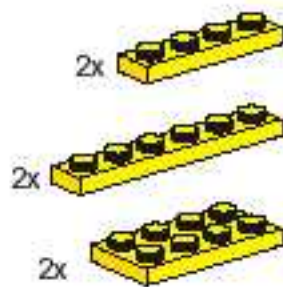

3

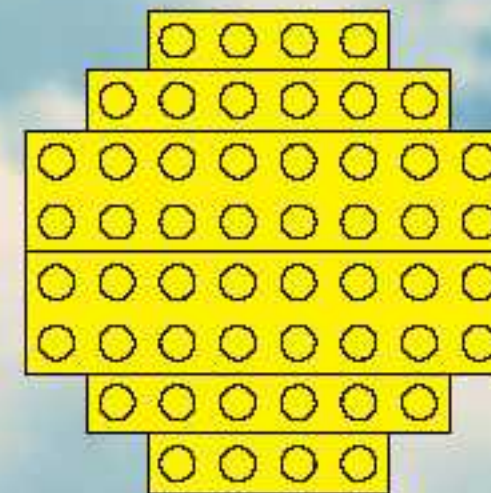
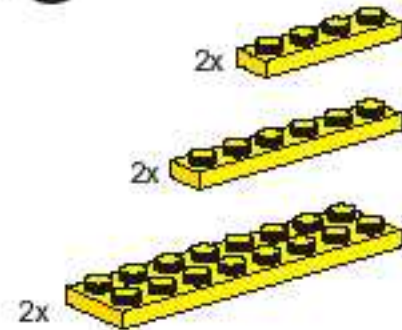

4

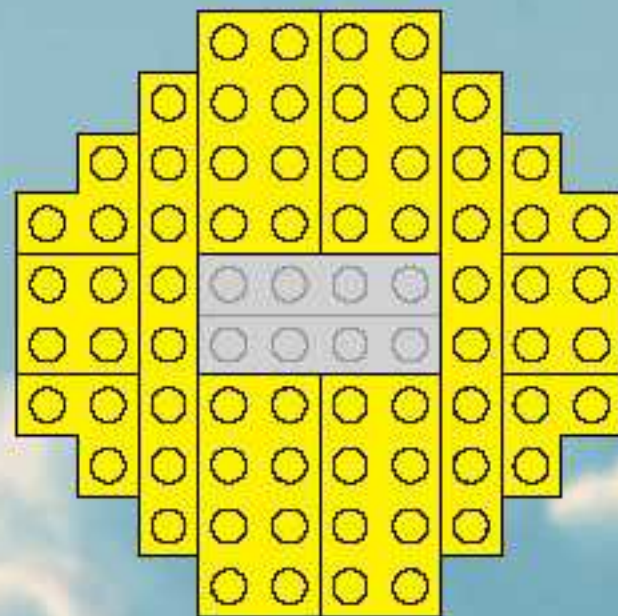
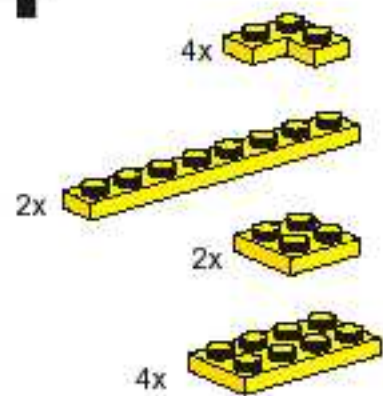

6

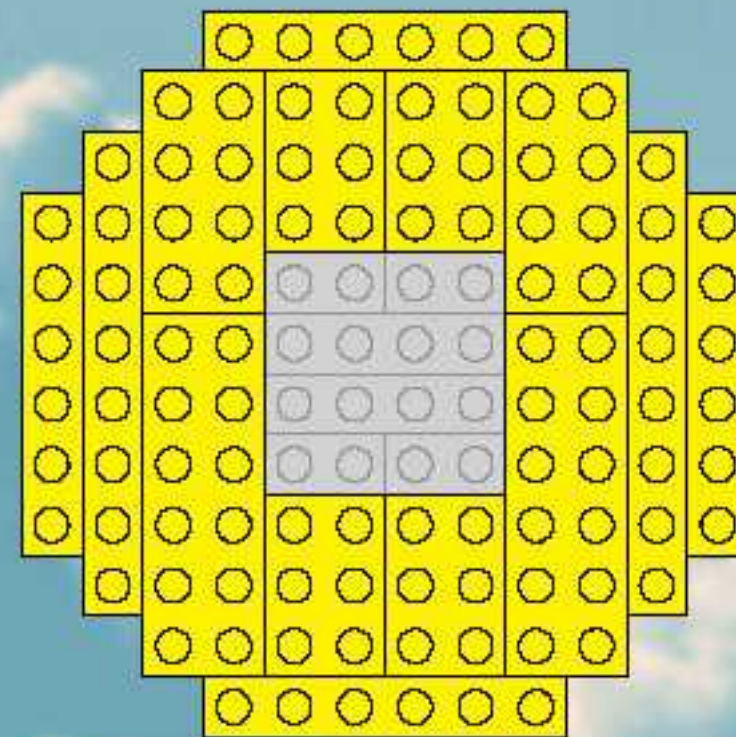
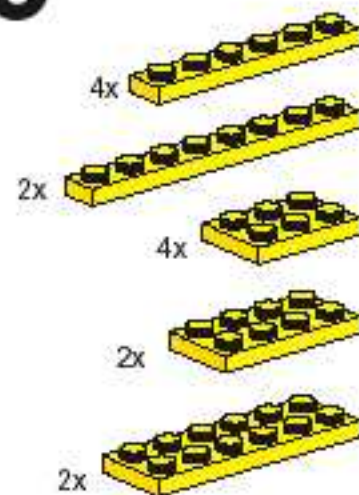

5

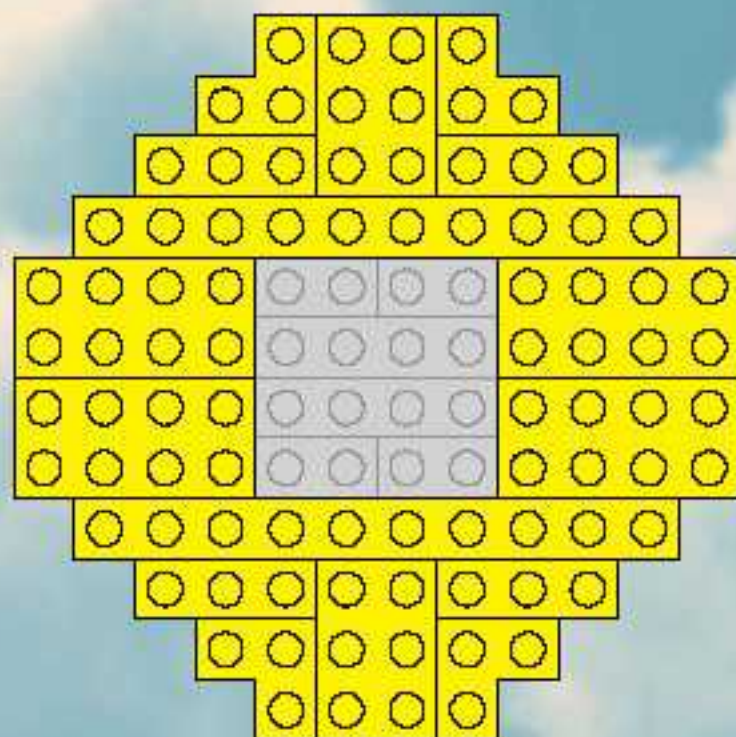
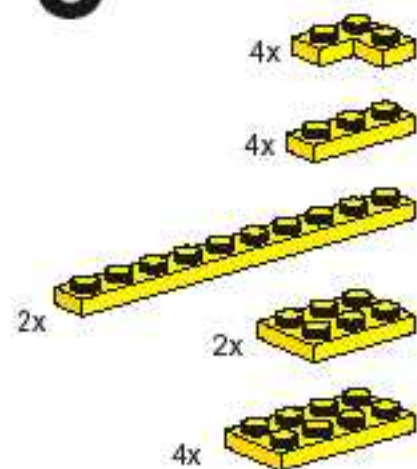

7

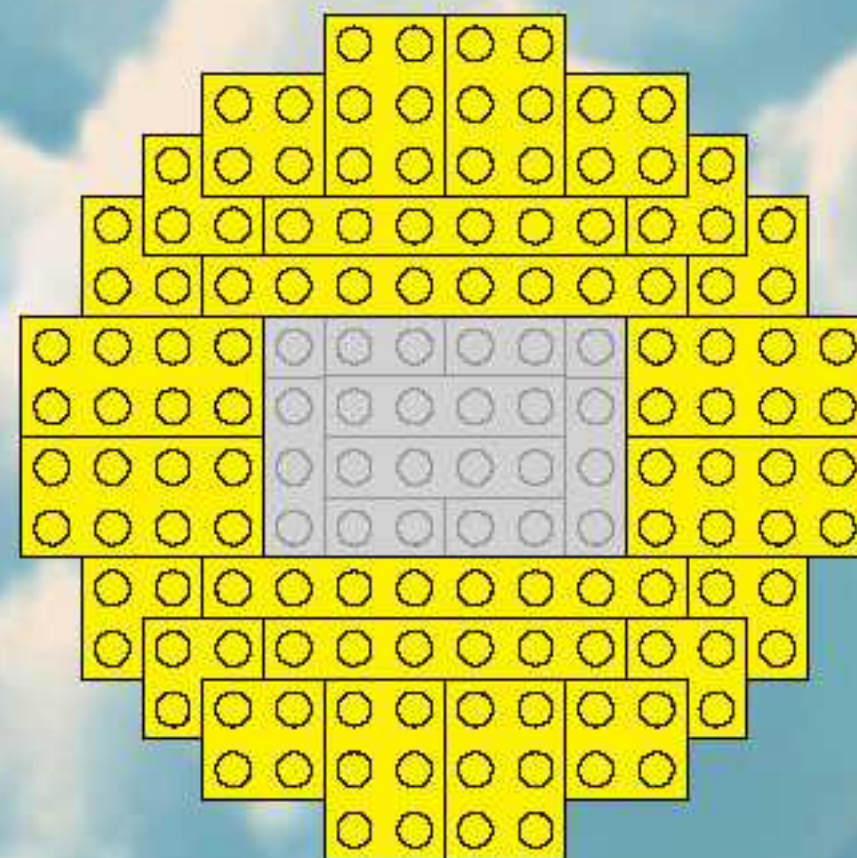
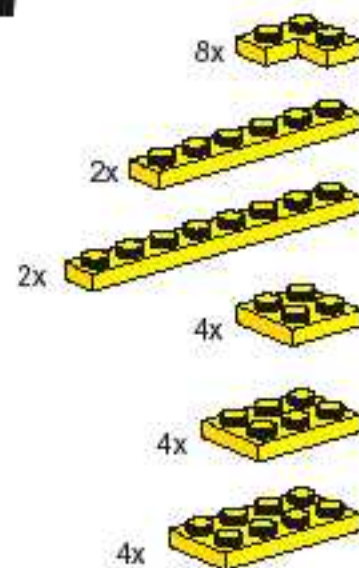

8

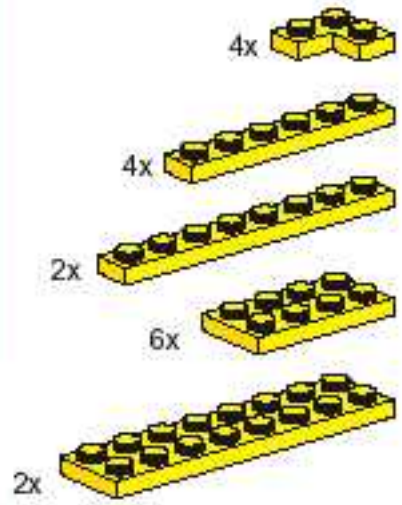

9

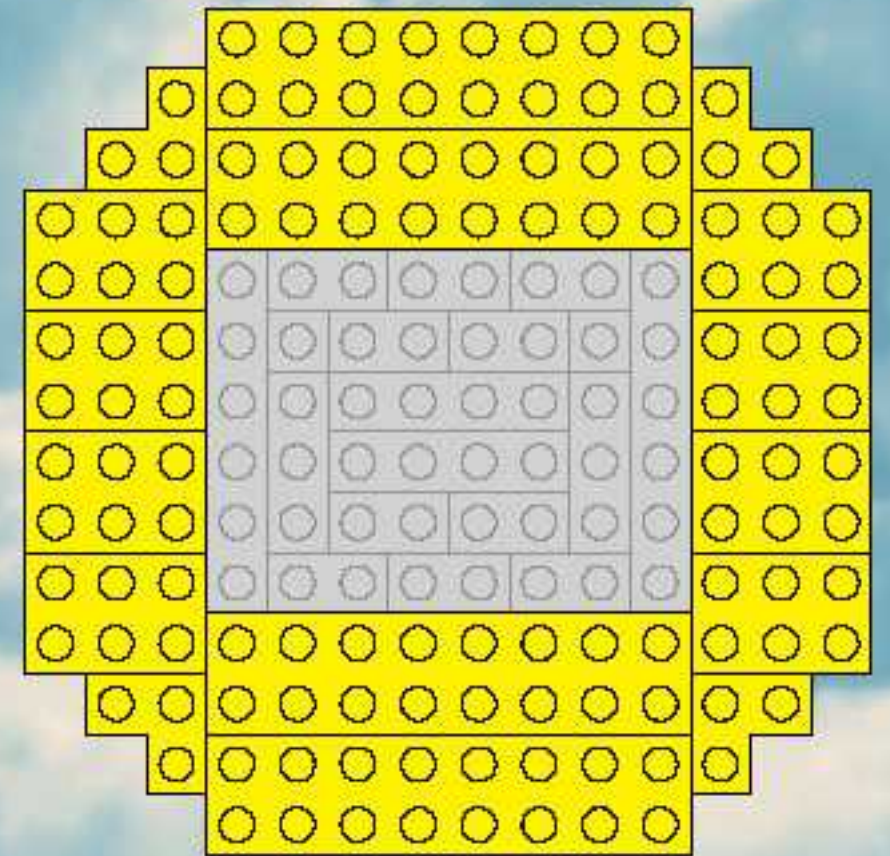
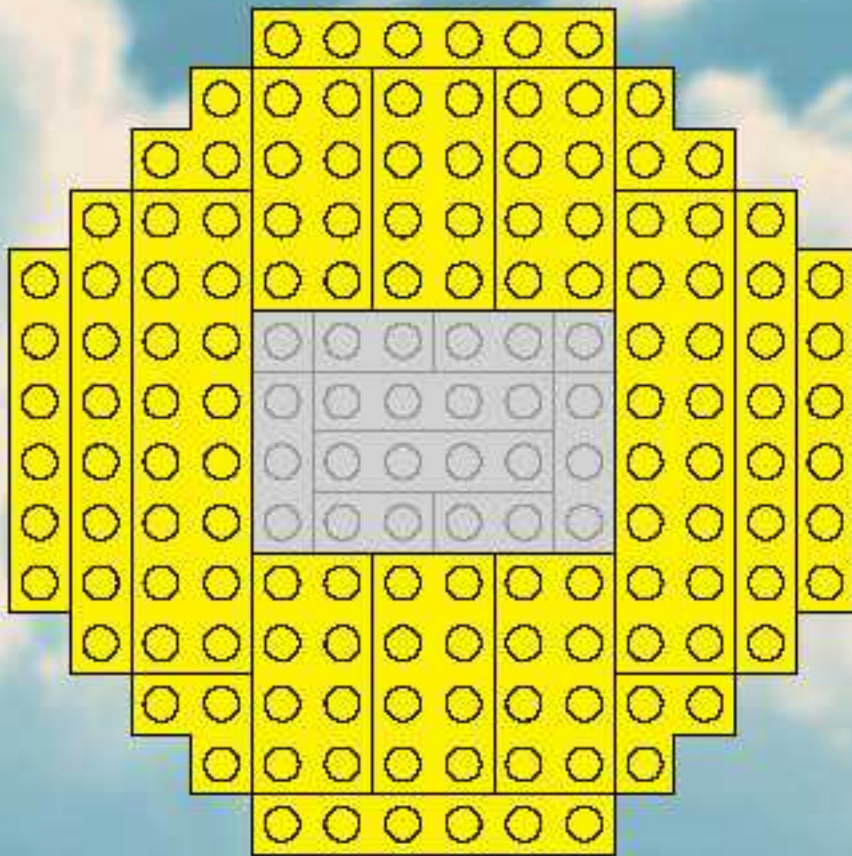
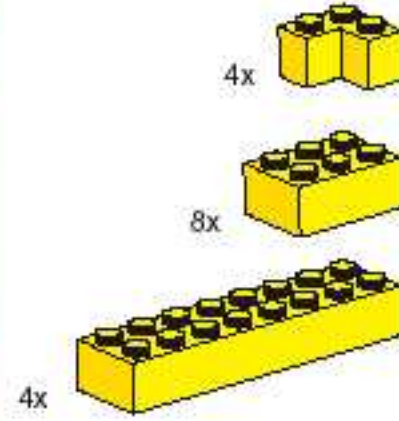

10

- 2x
- 2x
- 2x
- 1x
- 1x
- 1x
- 1x
- 2x
- 3x
- 5x
- 3x
- 2x
- 1x
- 1x

1

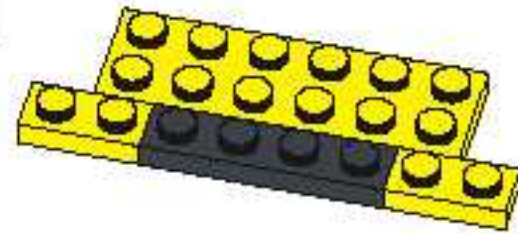

2



3

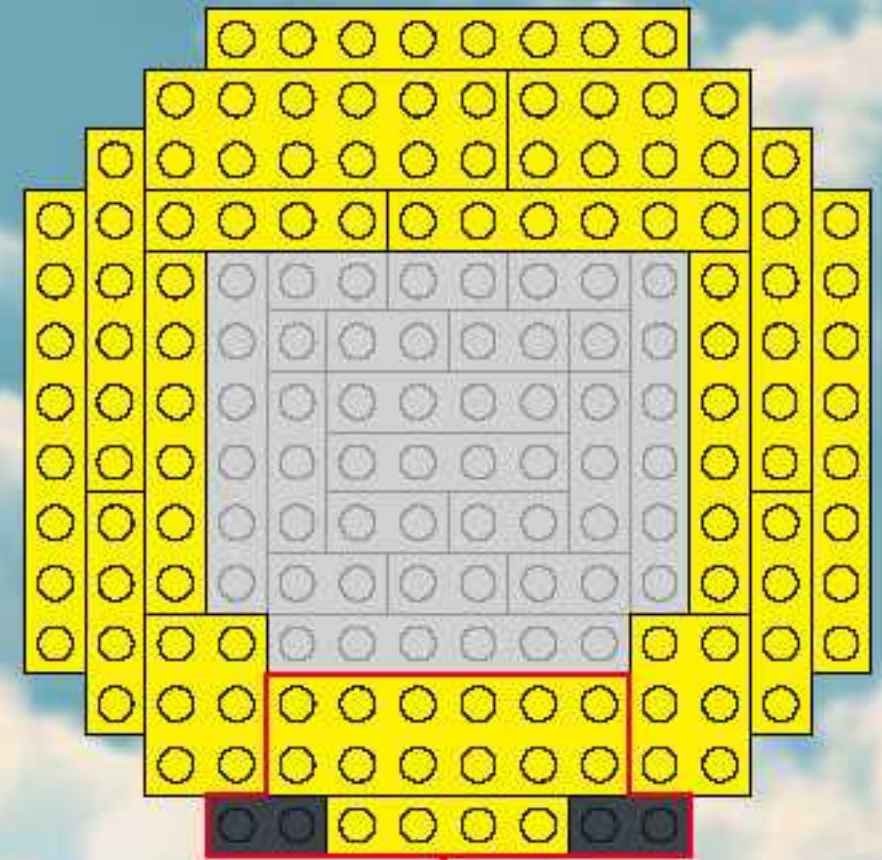
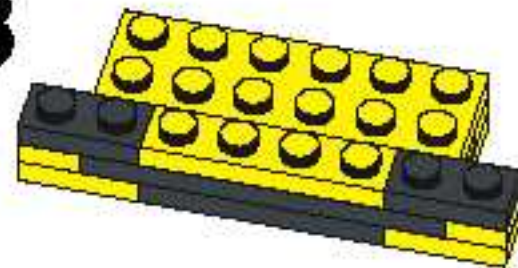

11



1



2

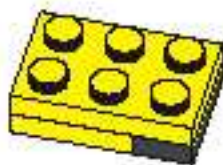

3

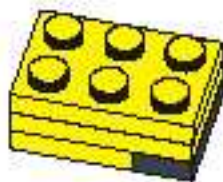

2x

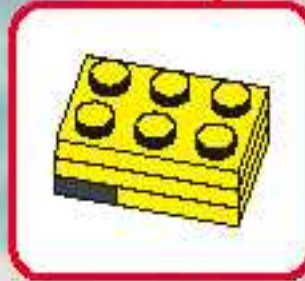
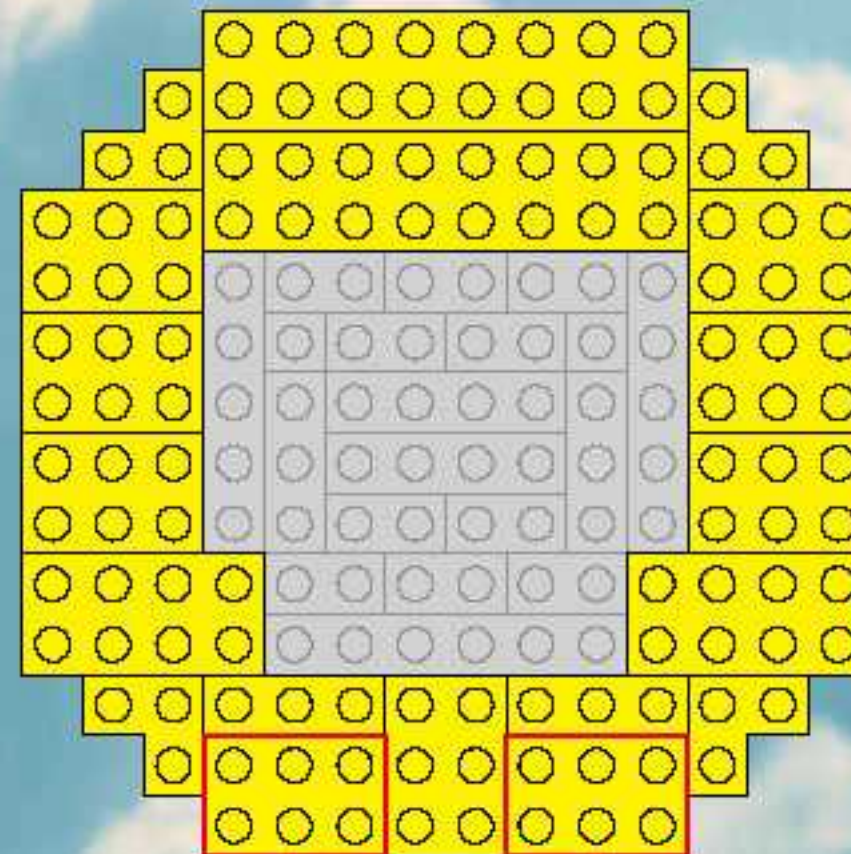

12

- 2x
- 2x
- 1x
- 1x
- 2x
- 2x
- 3x
- 1x
- 2x

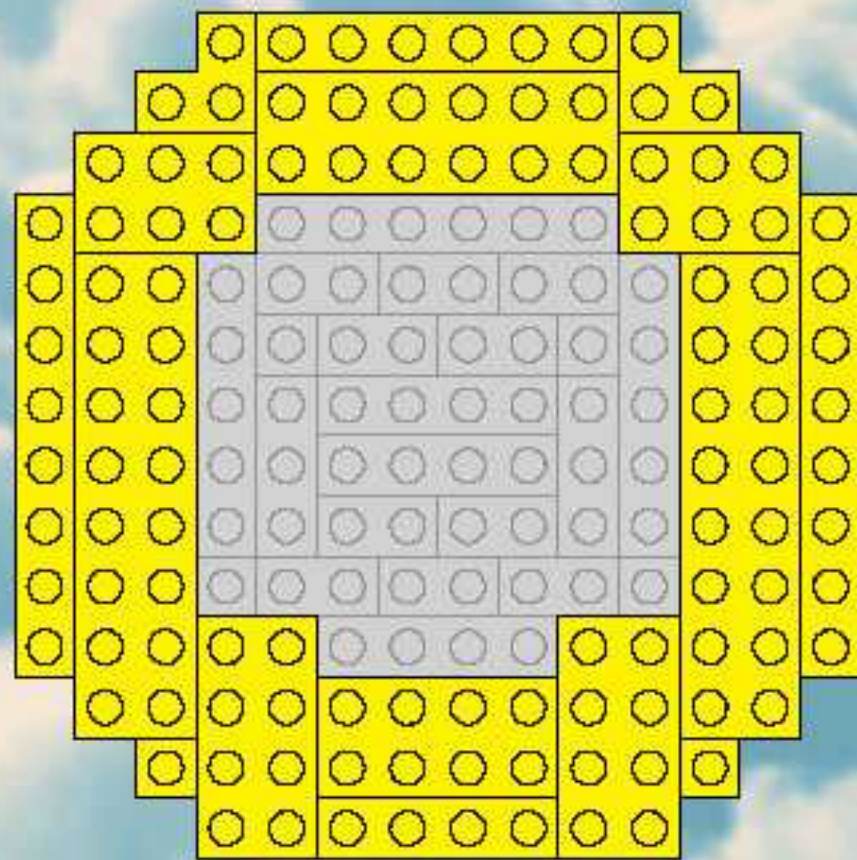

13

- 2x
- 2x
- 2x
- 6x
- 1x
- 1x
- 2x
- 2x
- 6x
- 2x

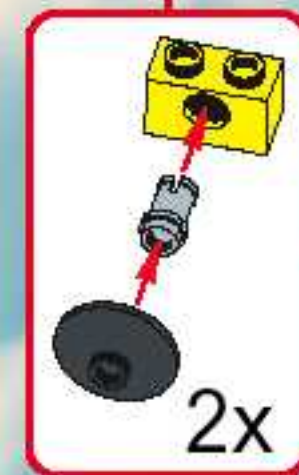
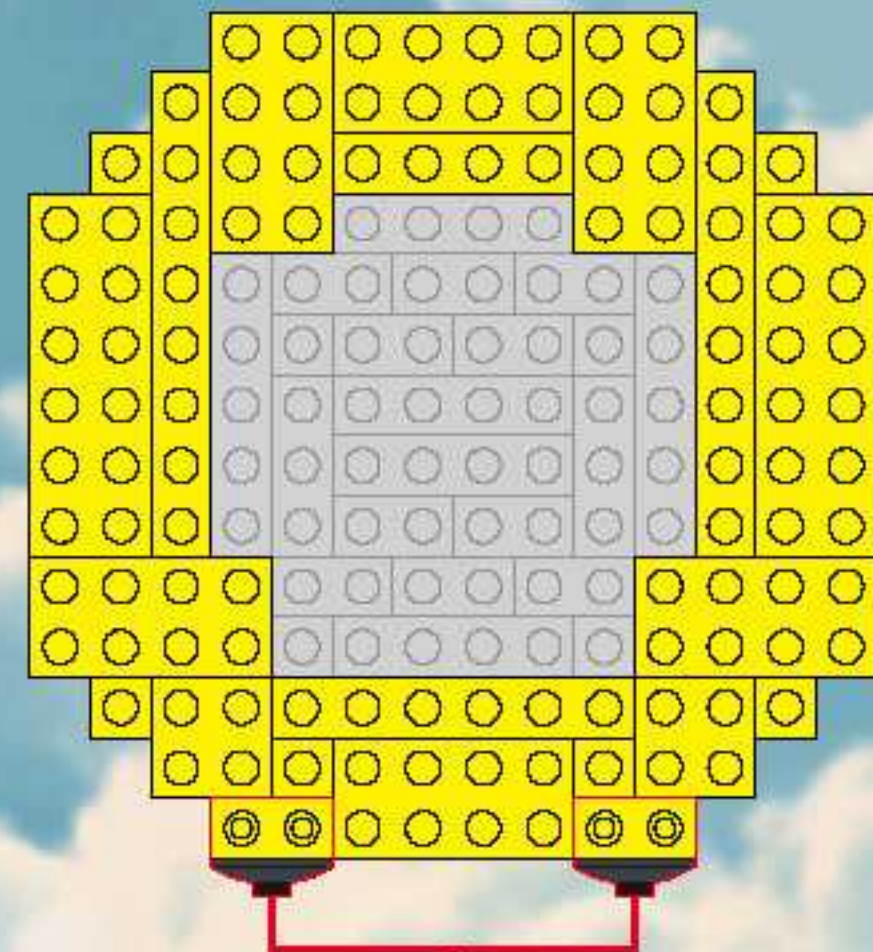

14

2x

2x

2x

4x

2x

6x

2x

2x

3x

1x

1x

4x

2x

1x

1

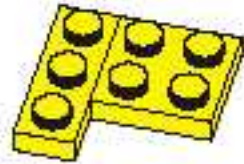

2

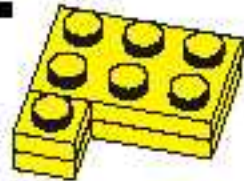

3



1

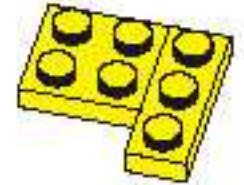

2

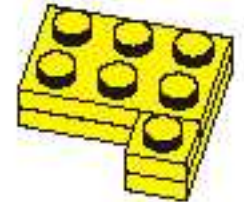

3

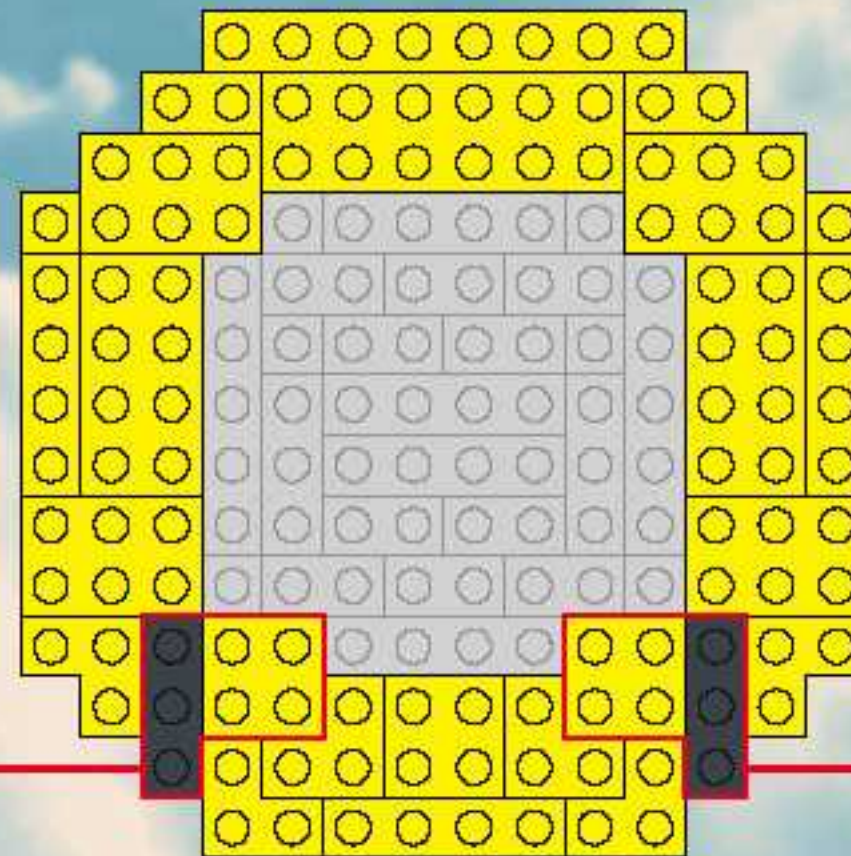

15

- 1x
- 2x
- 2x
- 1x
- 2x
- 4x
- 2x
- 4x
- 4x

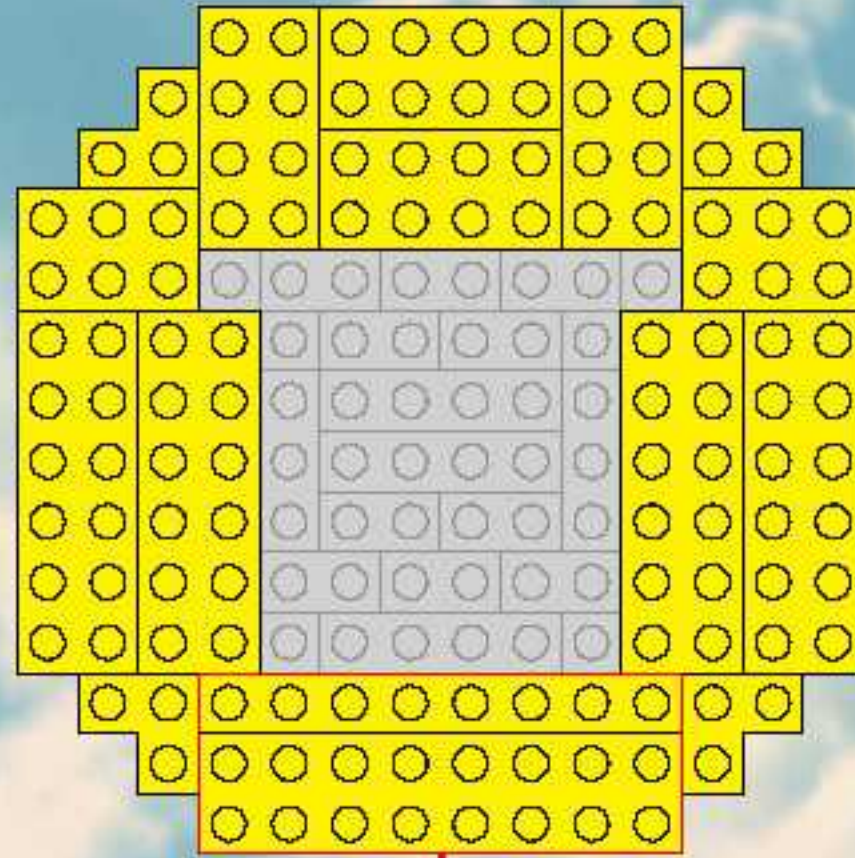

1

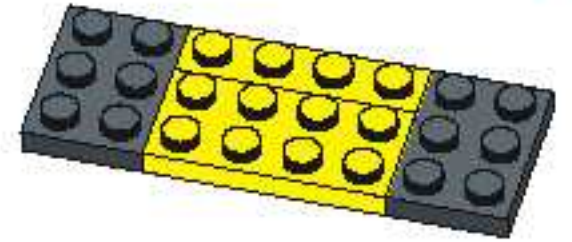

2

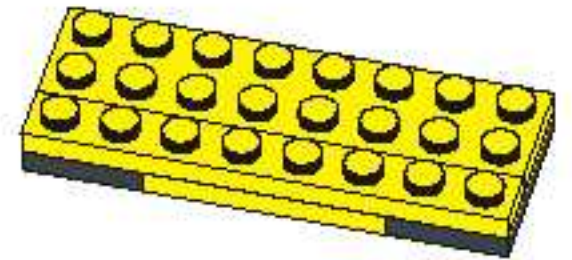

3

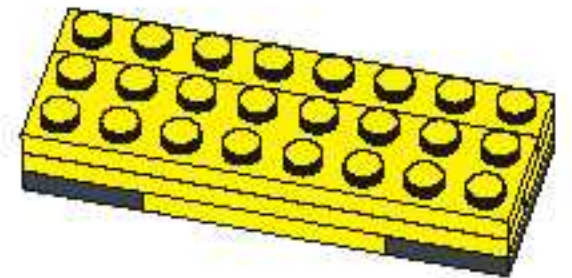

16

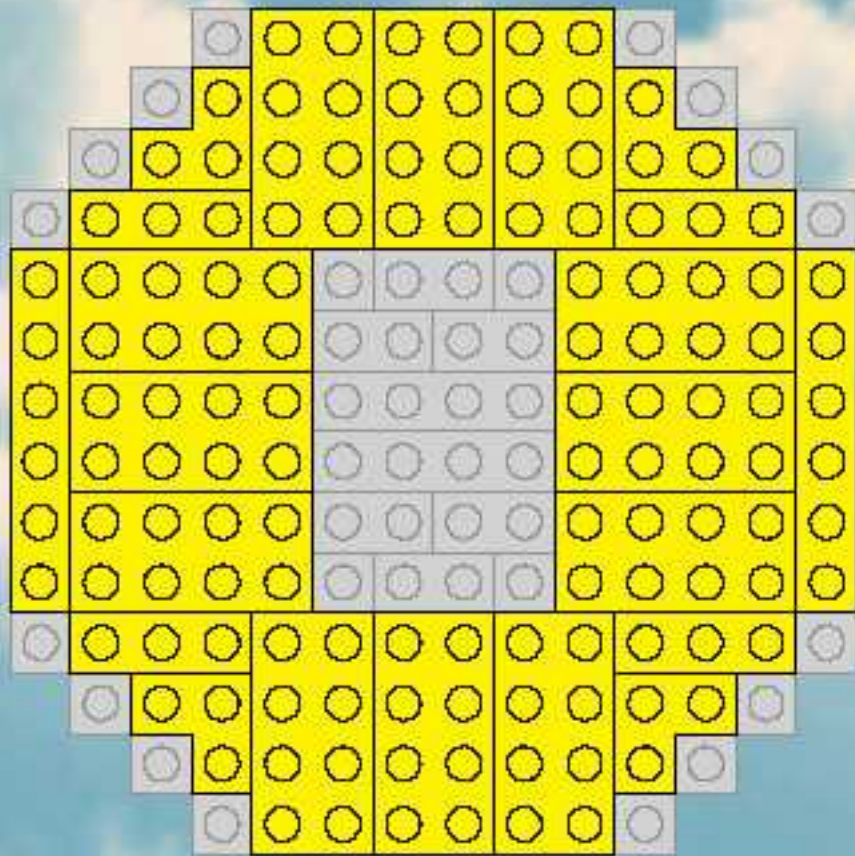

17

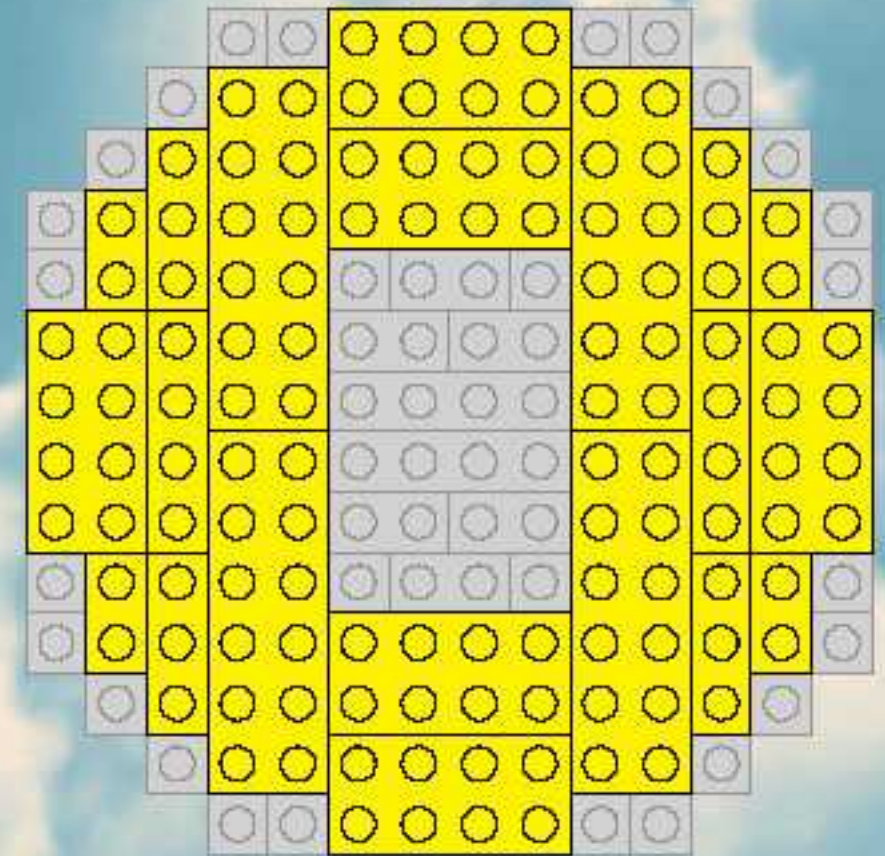
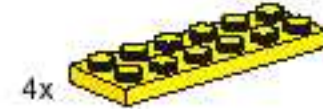

18

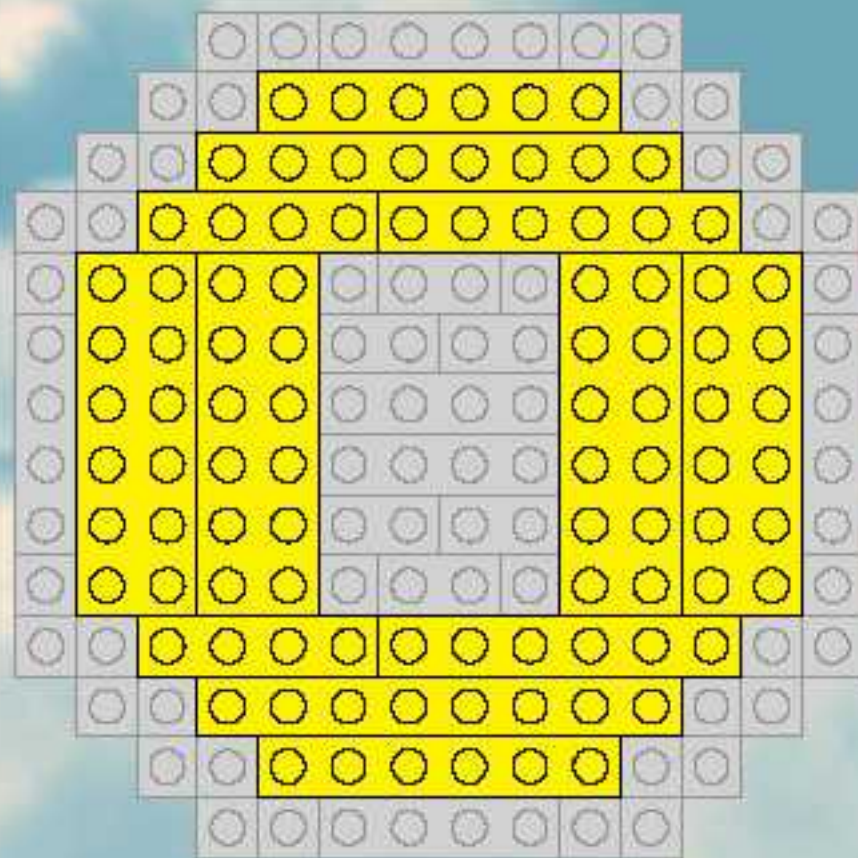
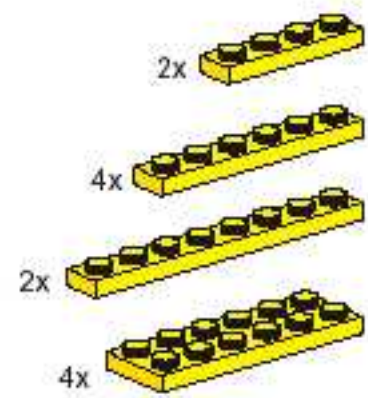

19

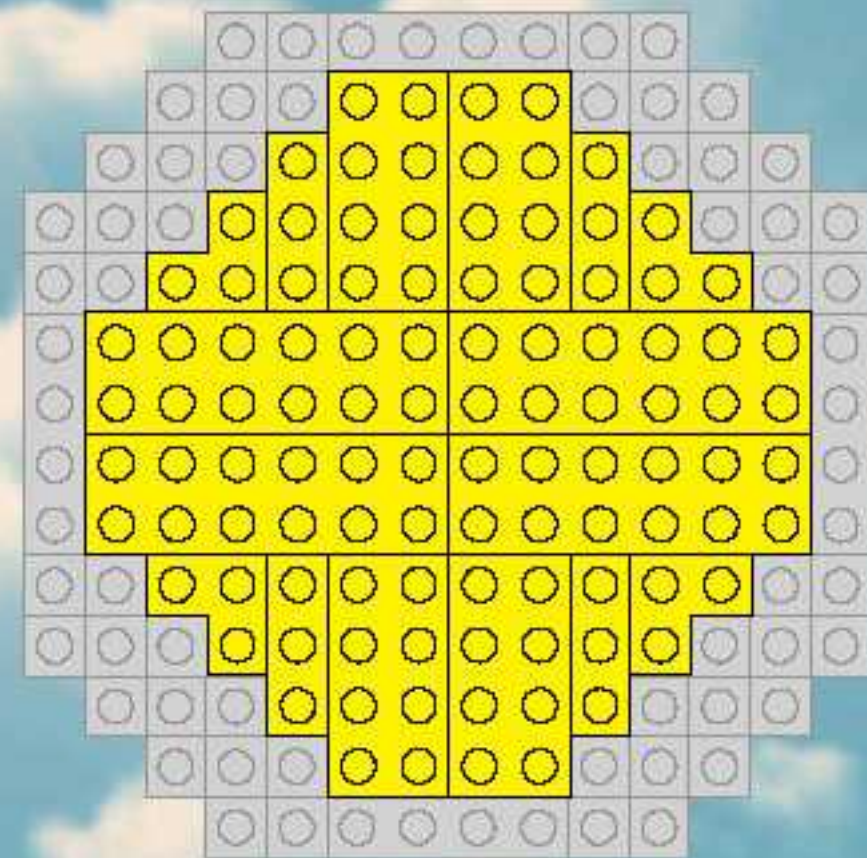
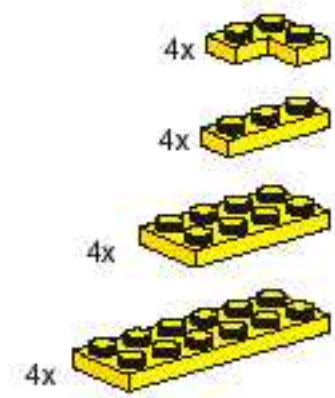

20

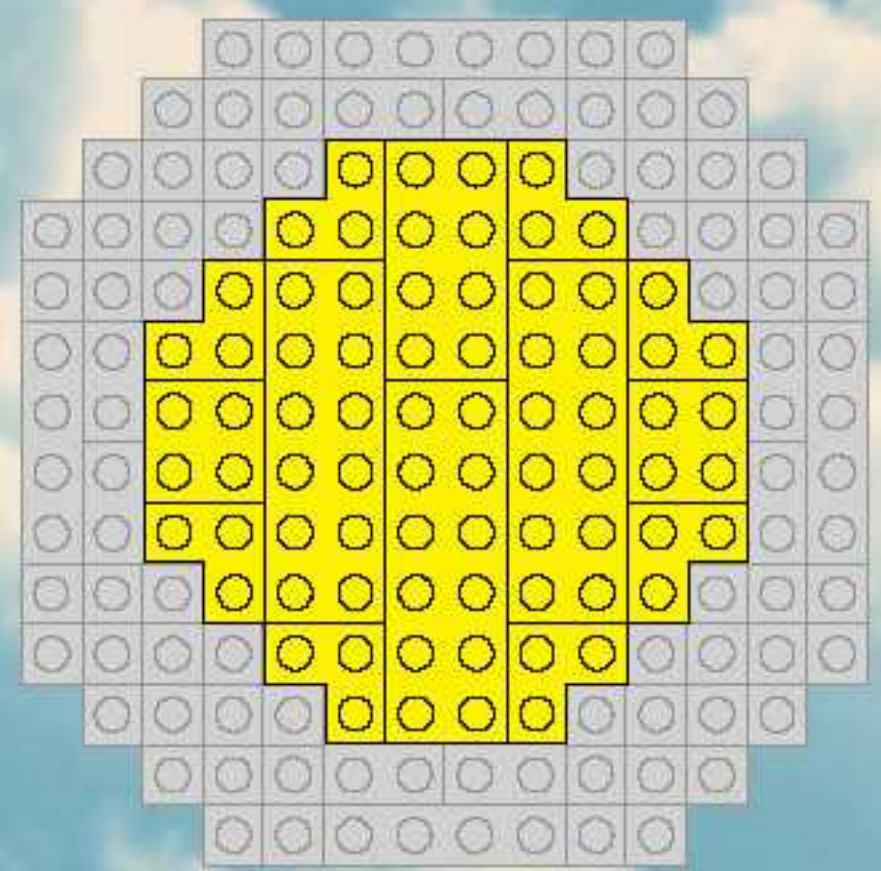

21

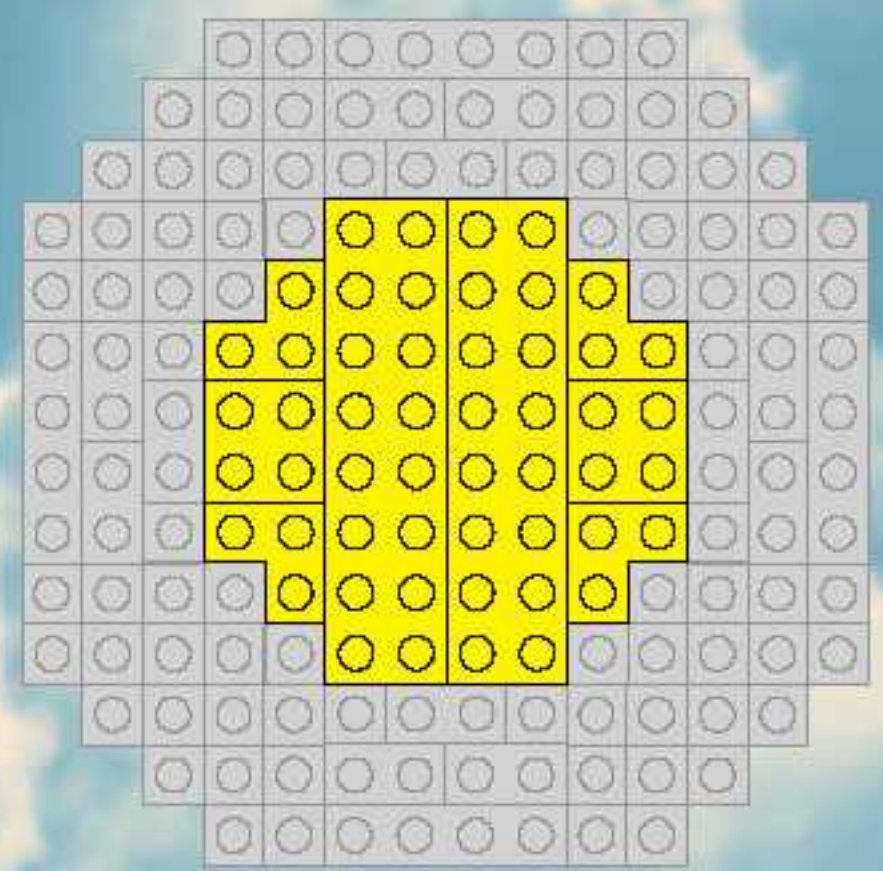
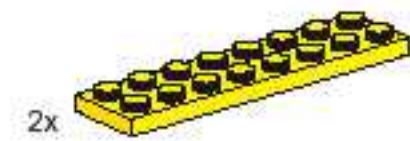

22





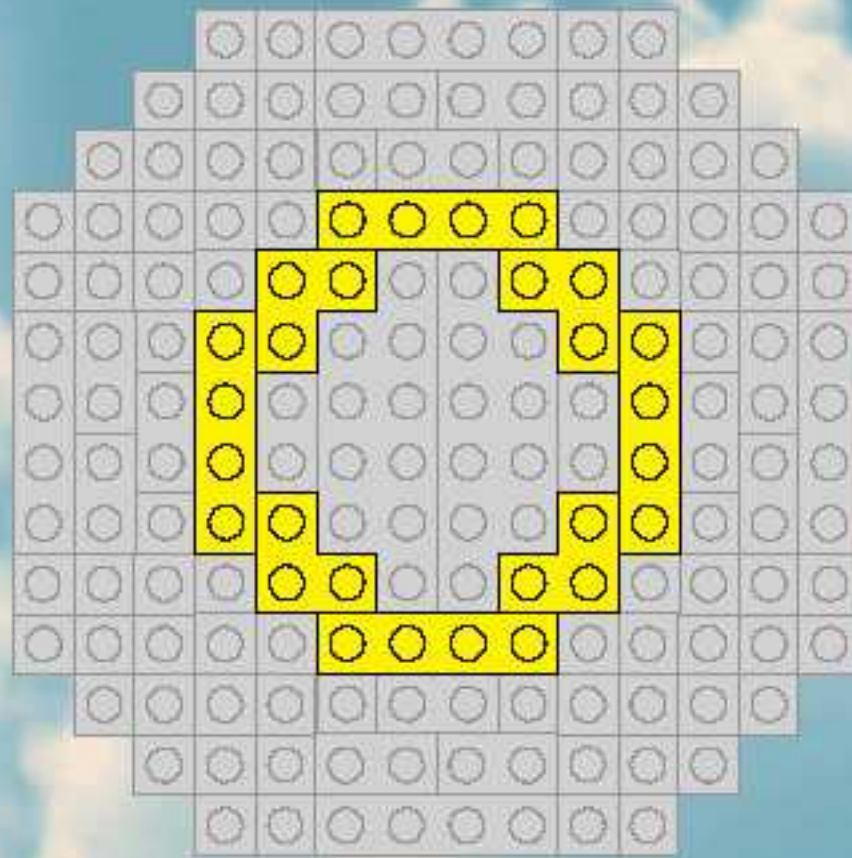

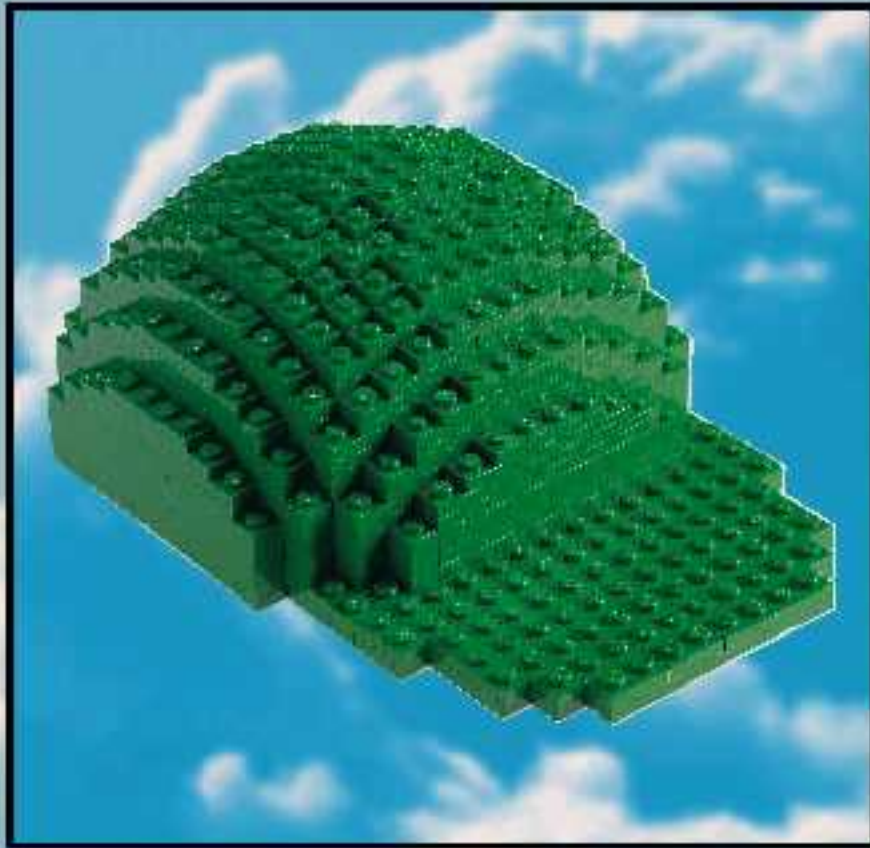

4x 

4x 





1

- 8x 
- 3x 
- 3x 
- 5x 
- 2x 
- 1x 
- 1x 
- 2x 

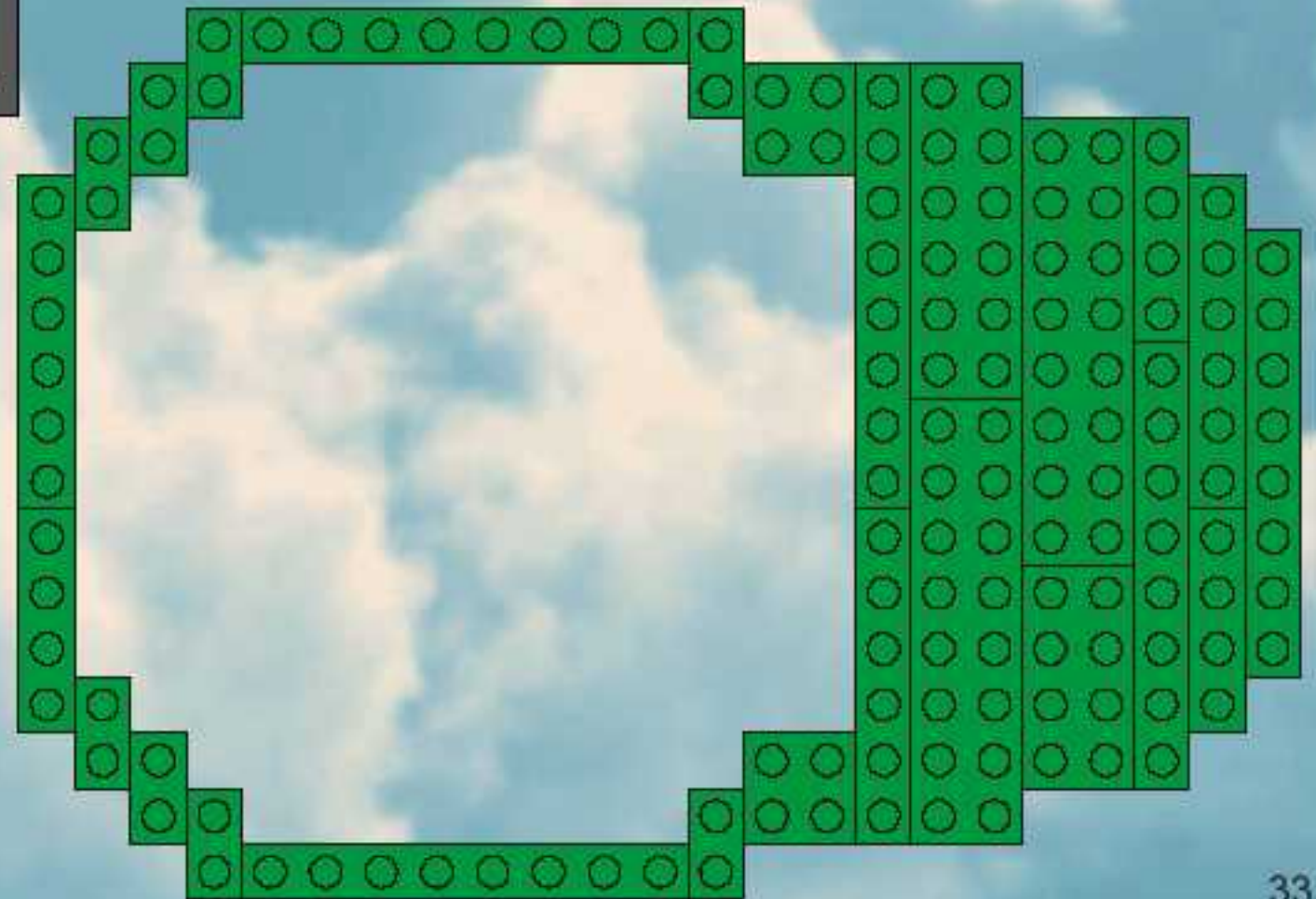

2

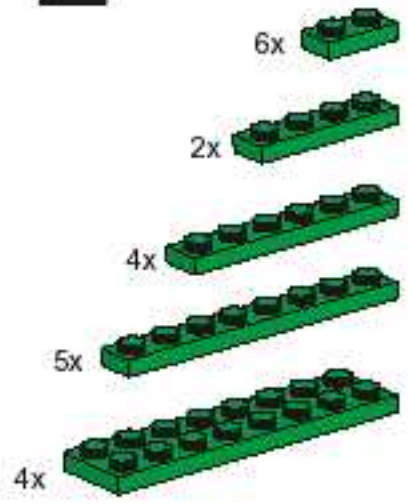

3

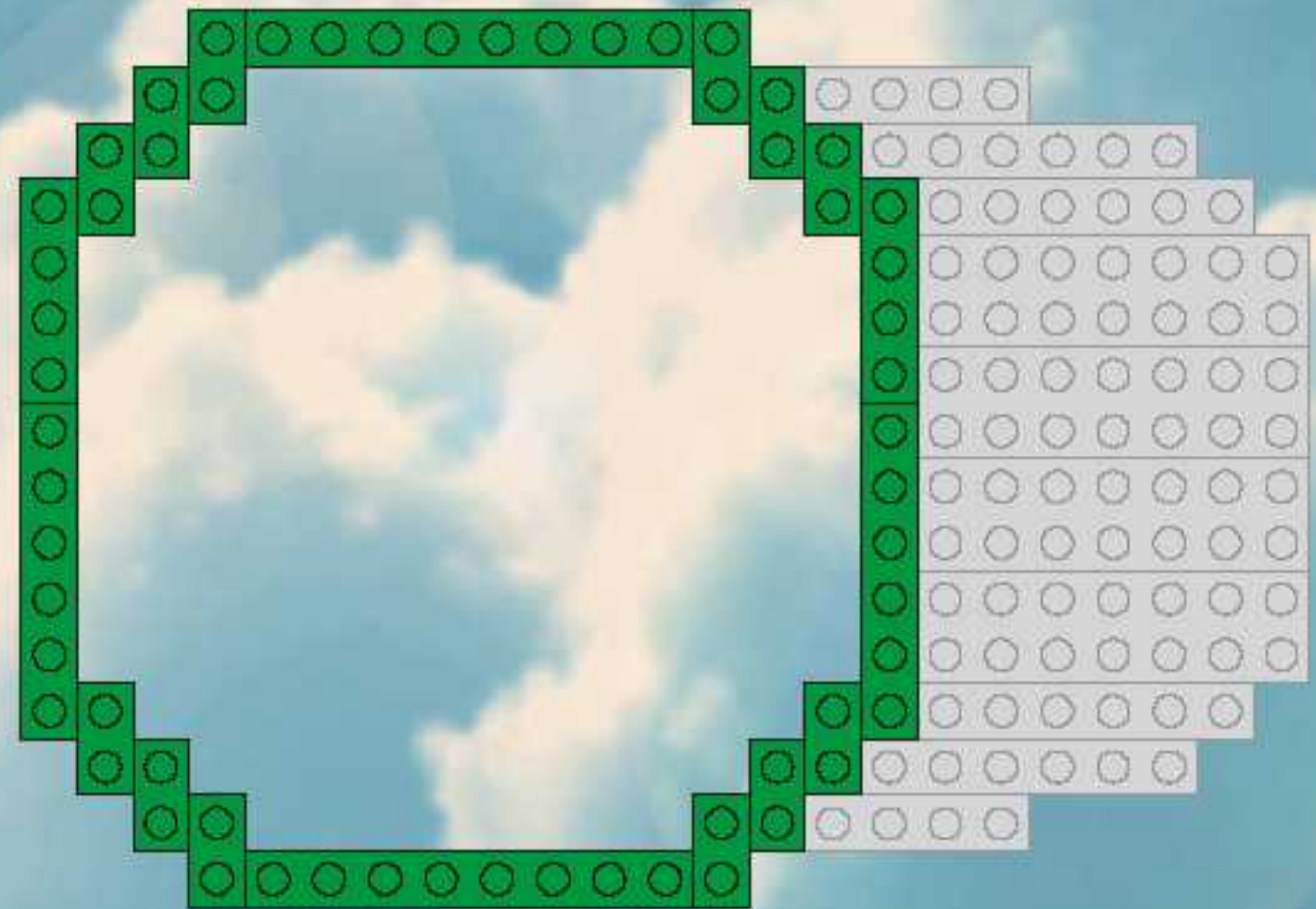
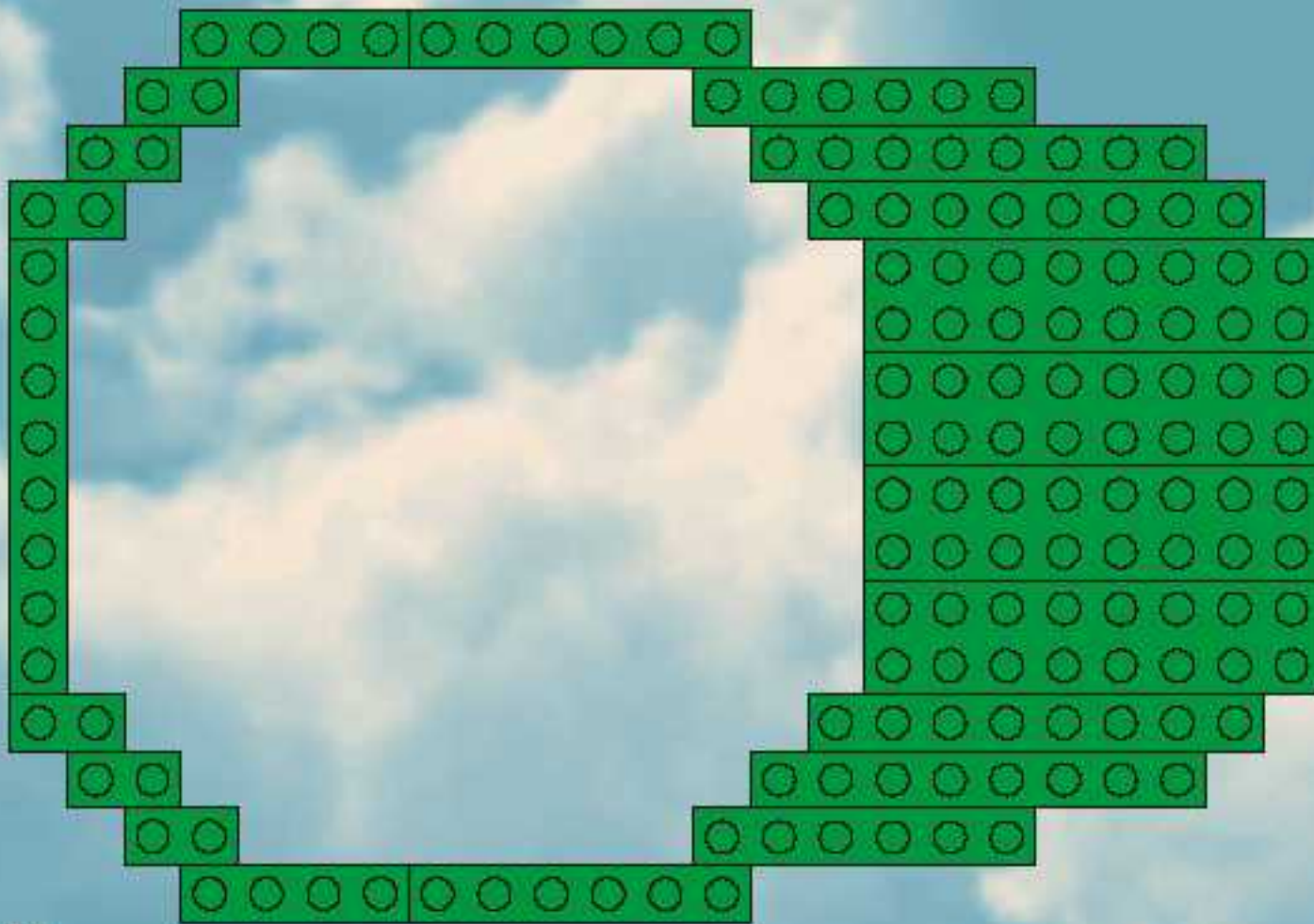
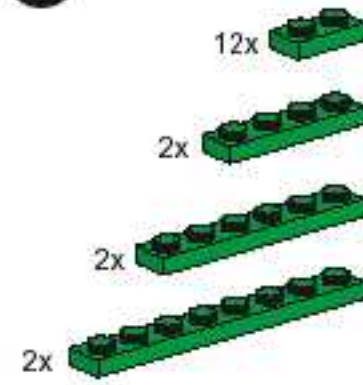

4

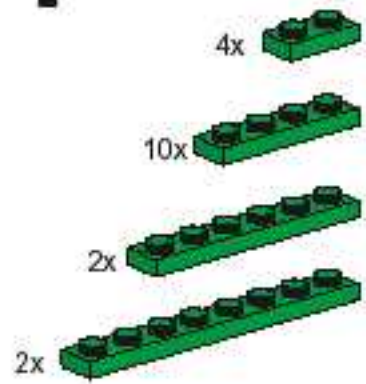

5

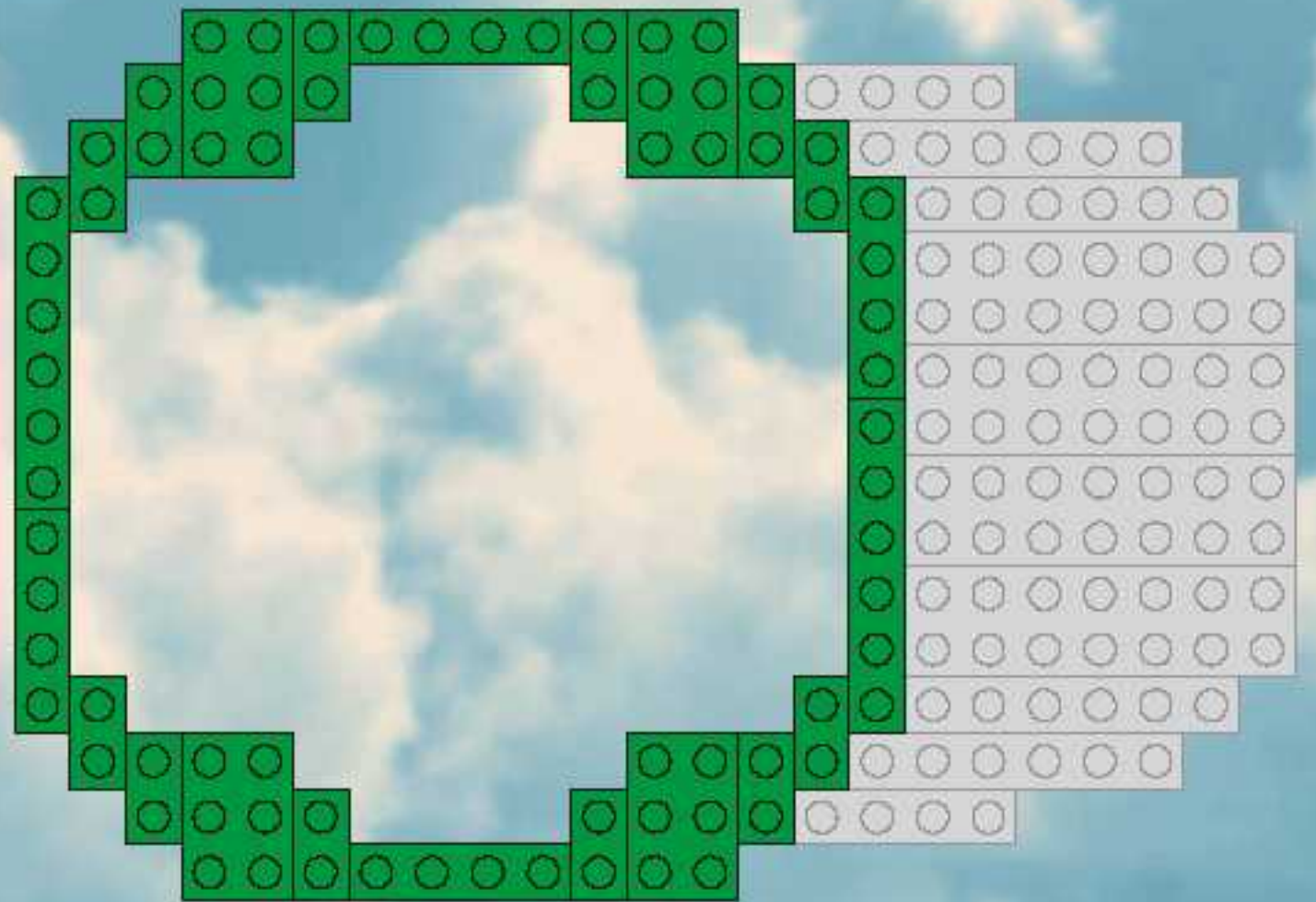
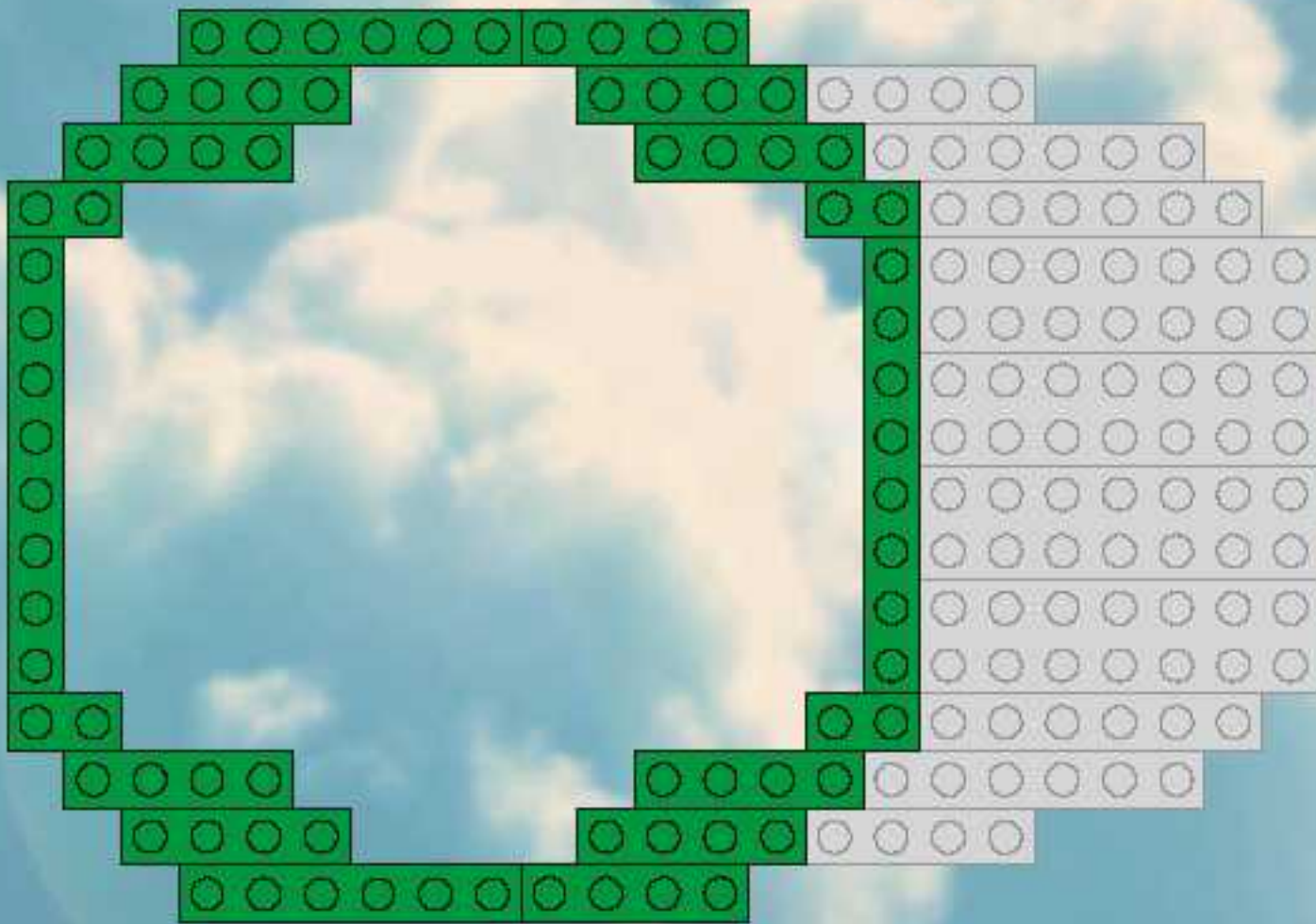
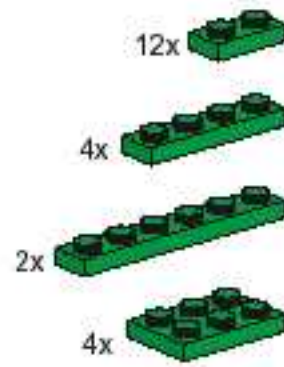



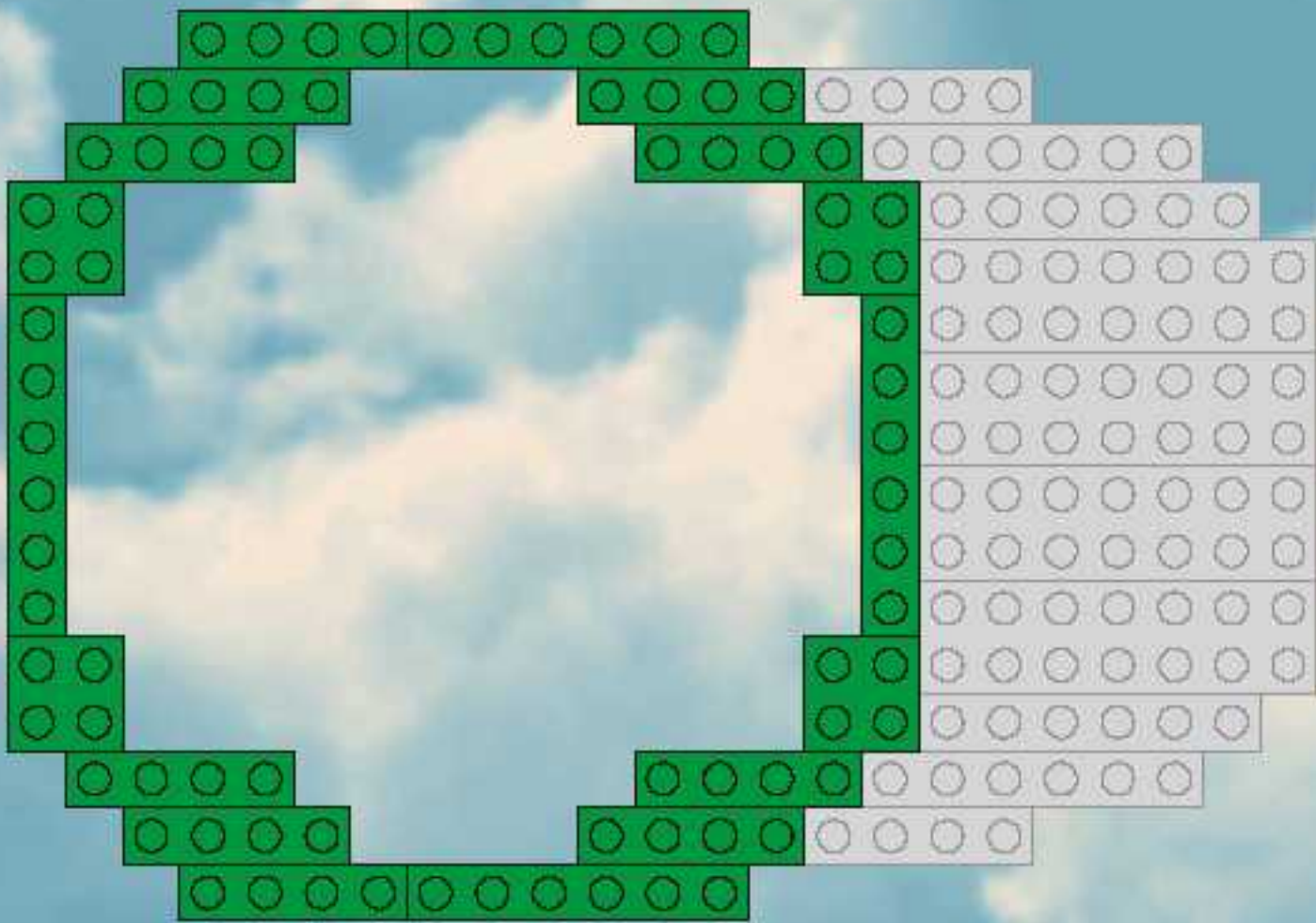
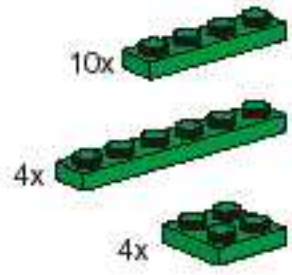

6

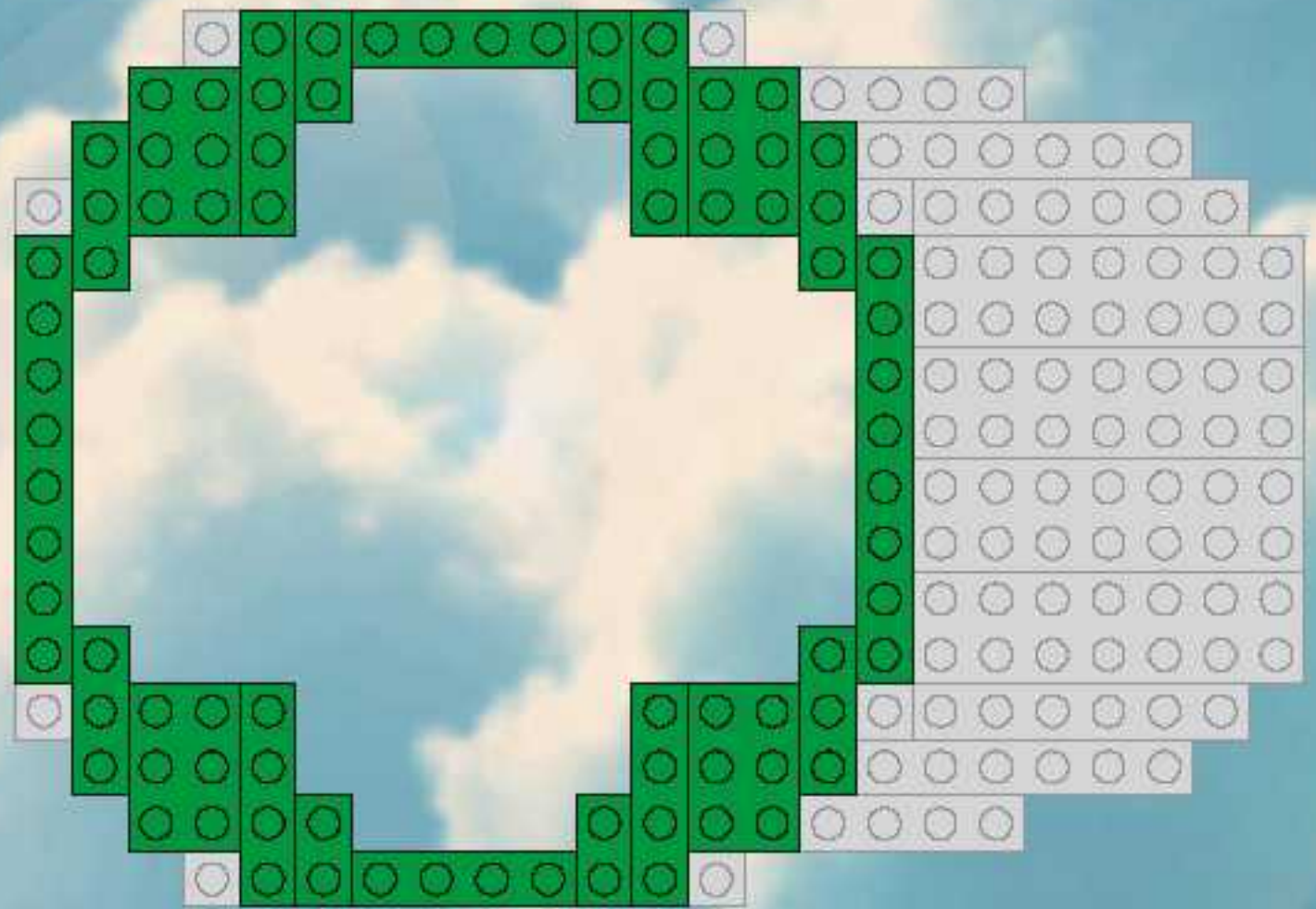
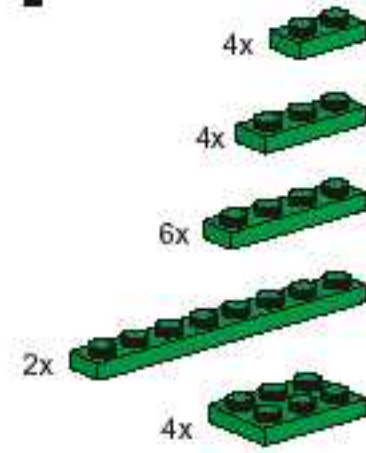





7



8

- 4x 
- 4x 
- 2x 
- 2x 
- 4x 

9

- 4x 
- 4x 
- 4x 
- 4x 

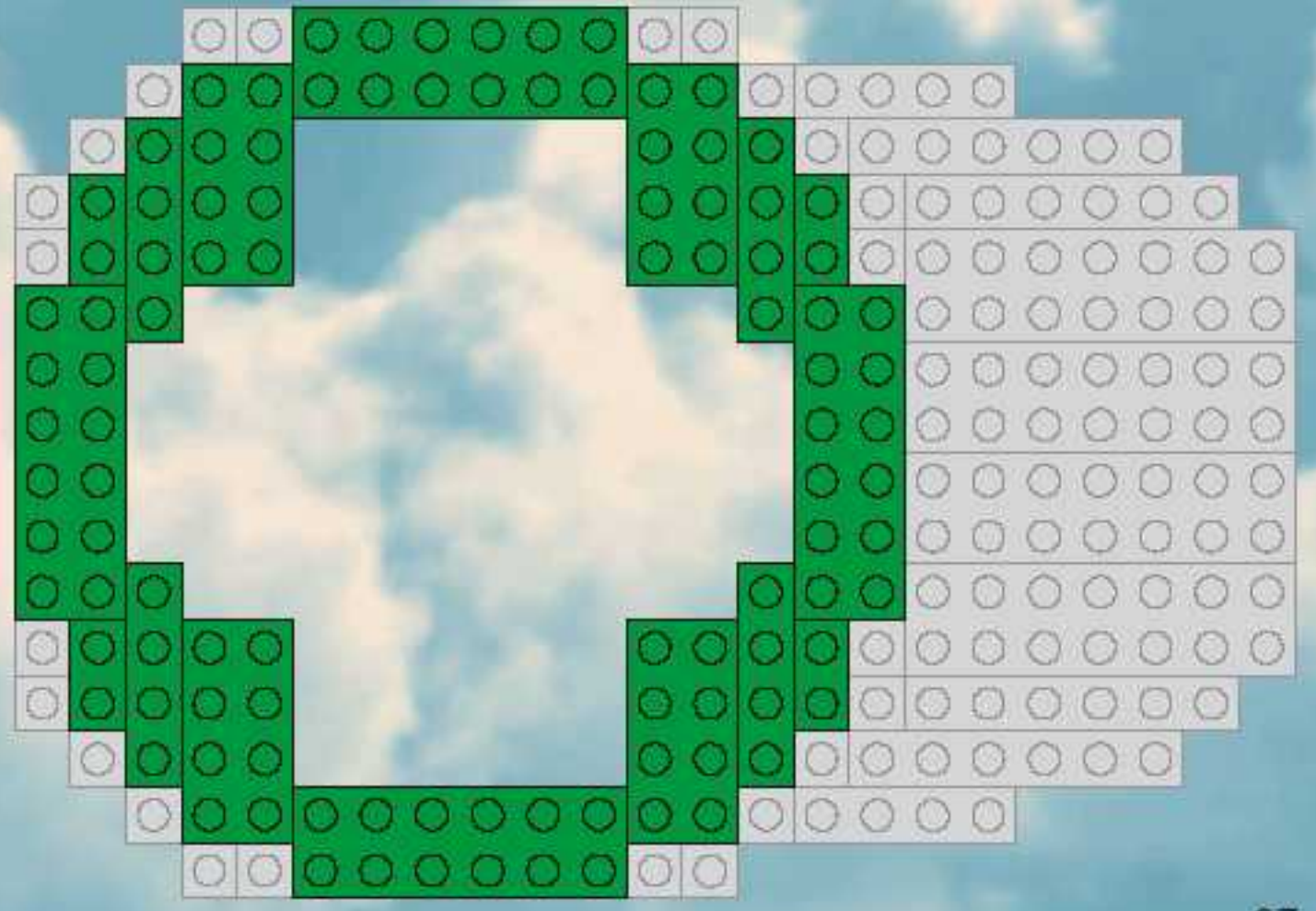
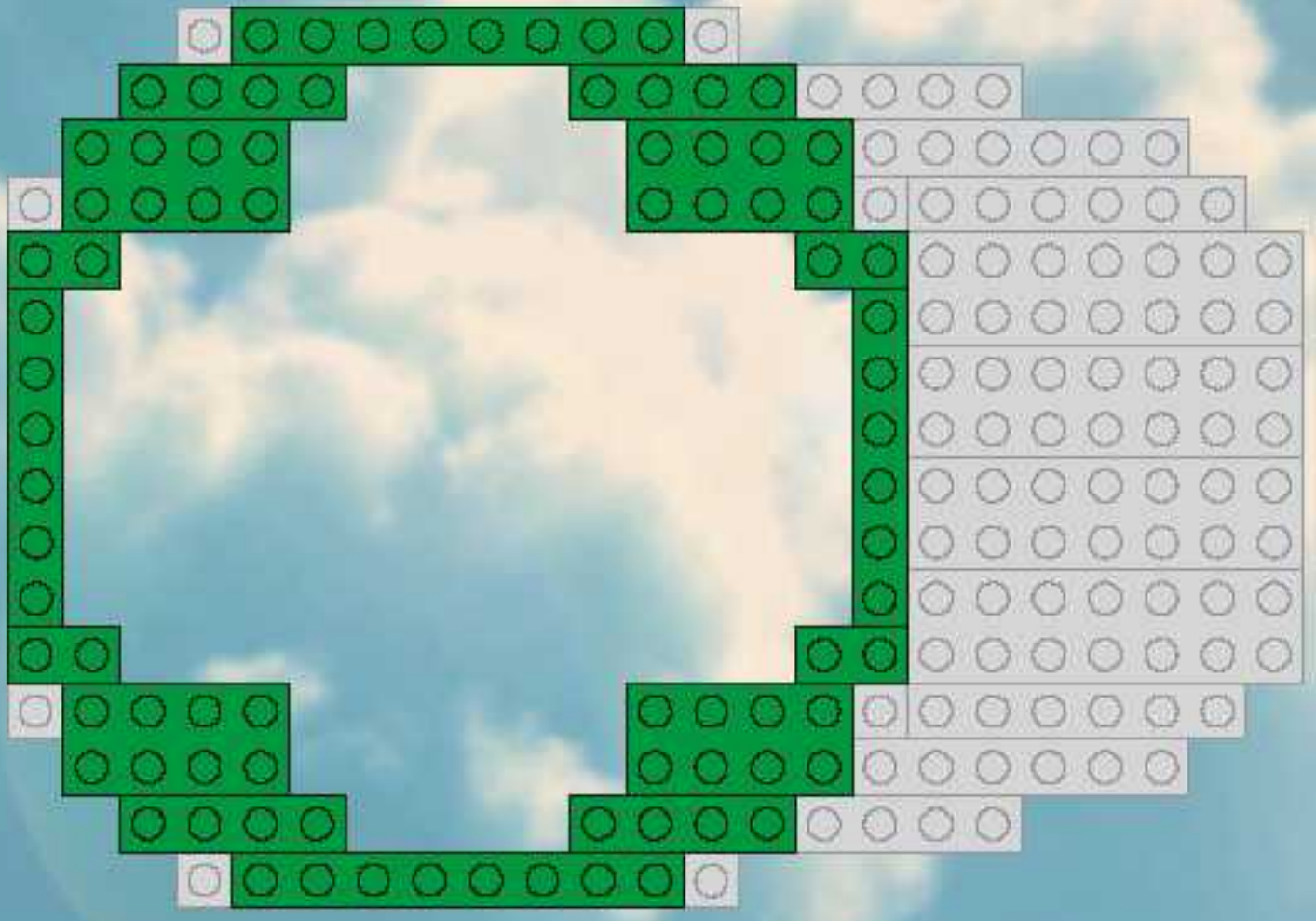

10

4x



4x



8x



4x



11

4x



2x



4x



2x

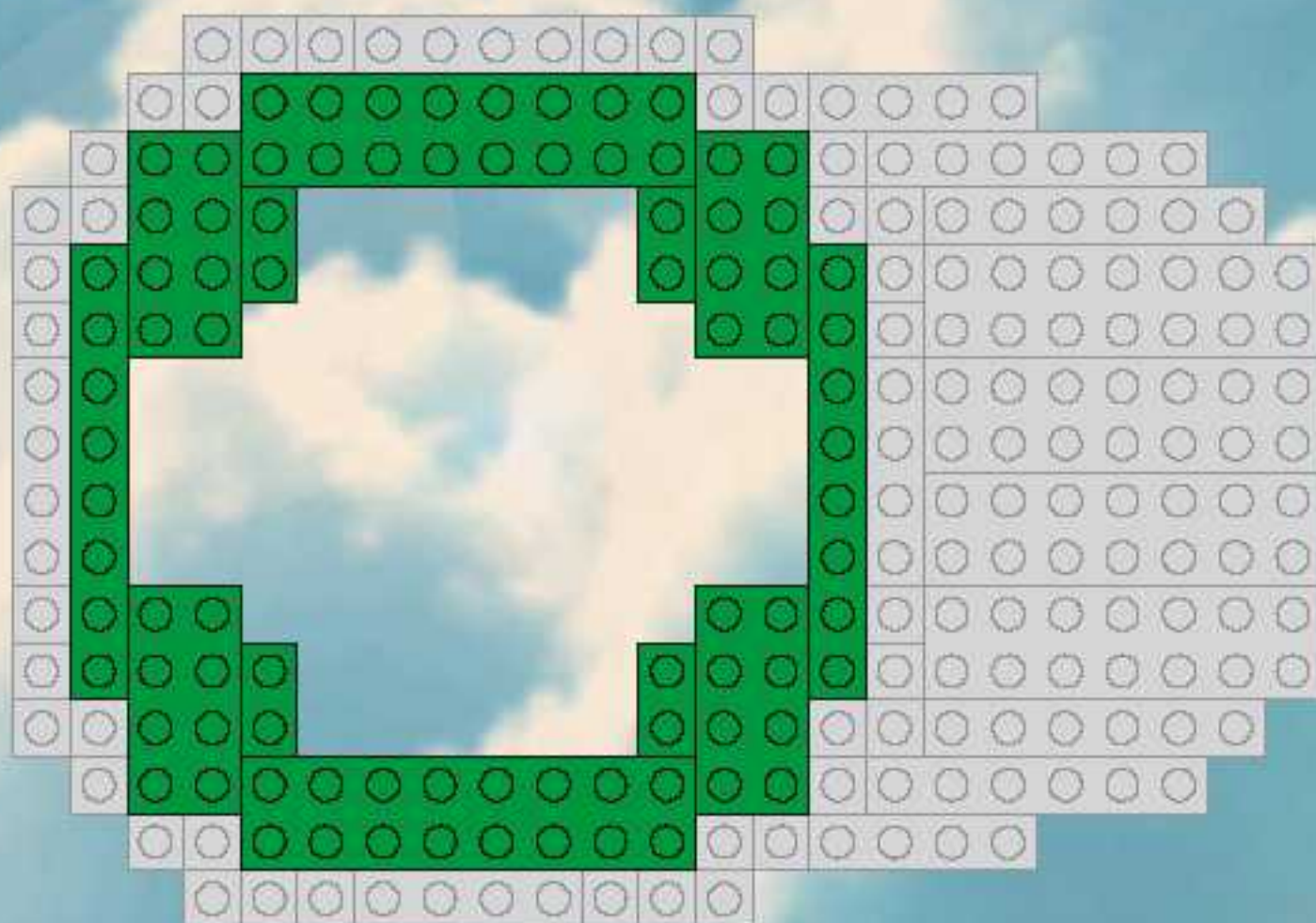
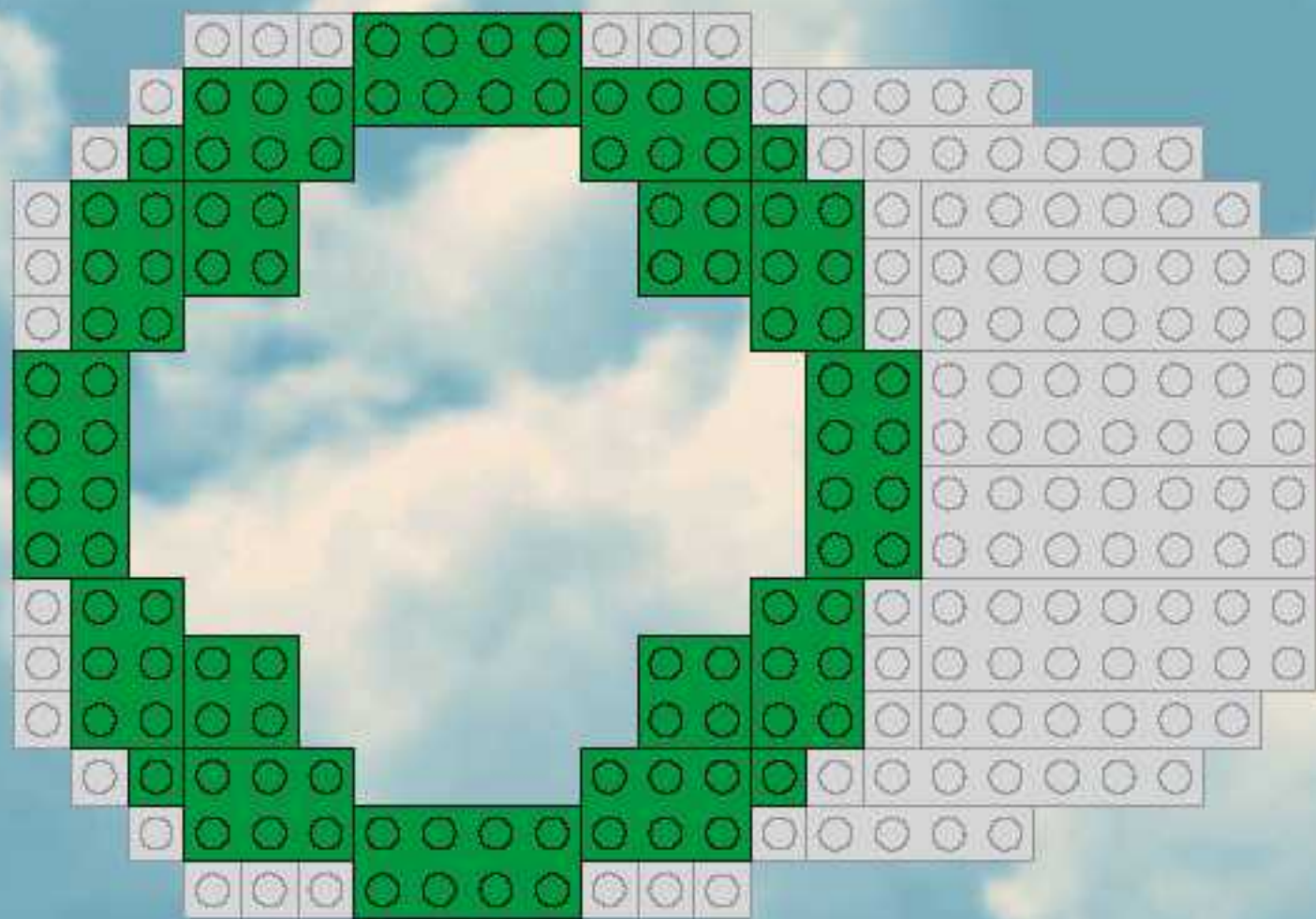

12

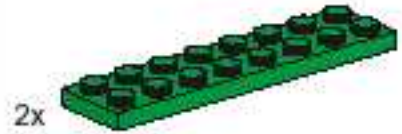

13

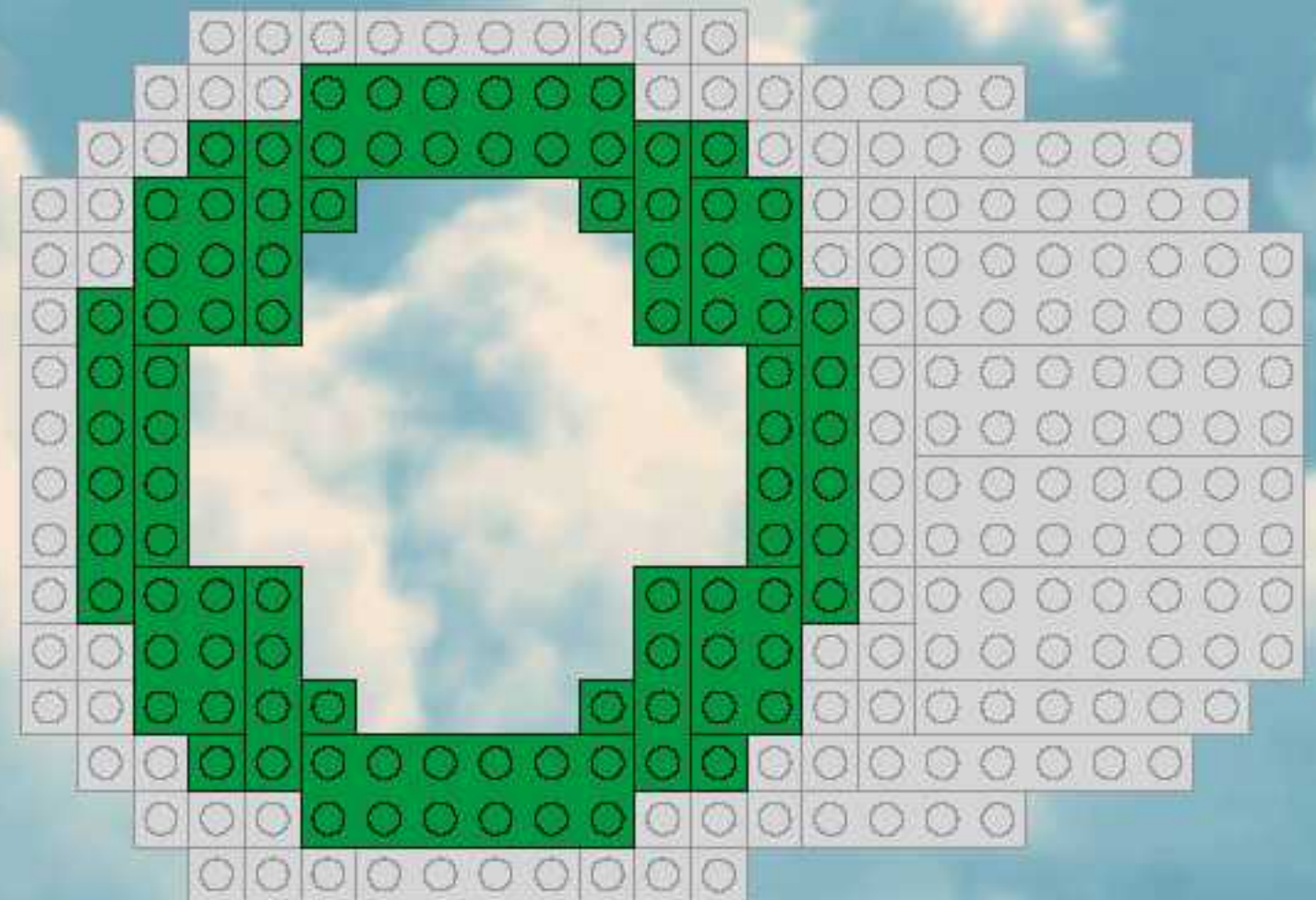
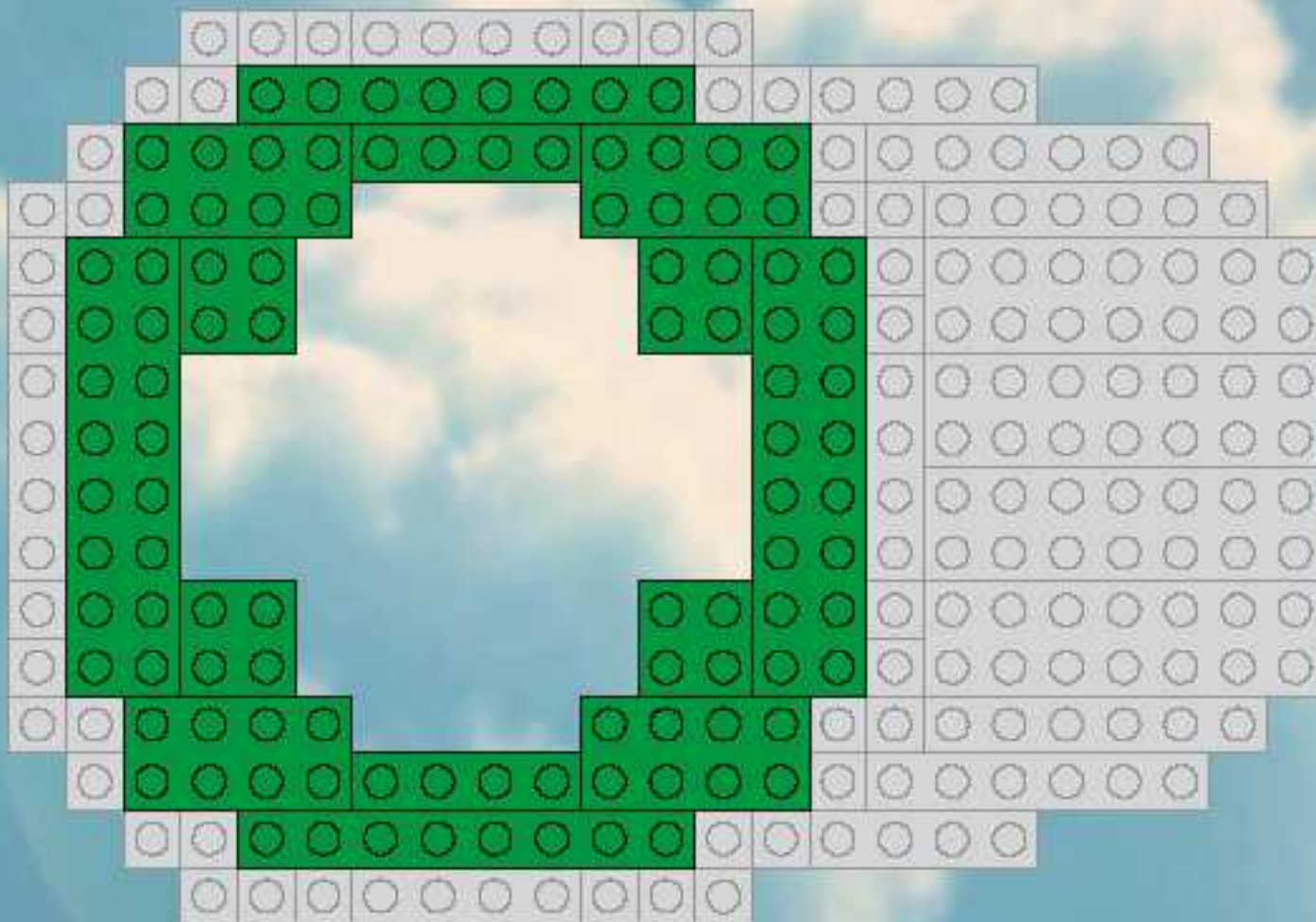

14



15

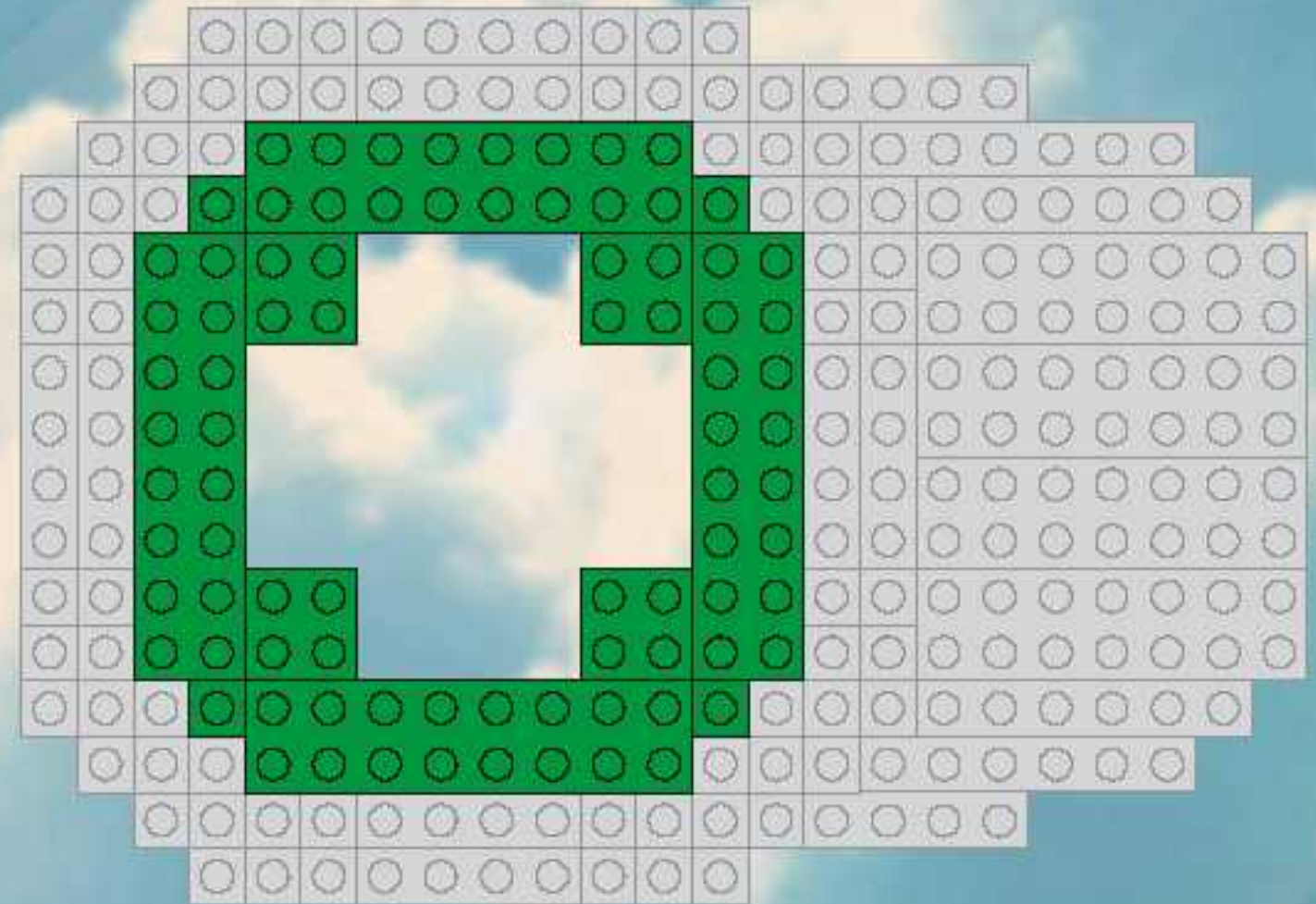
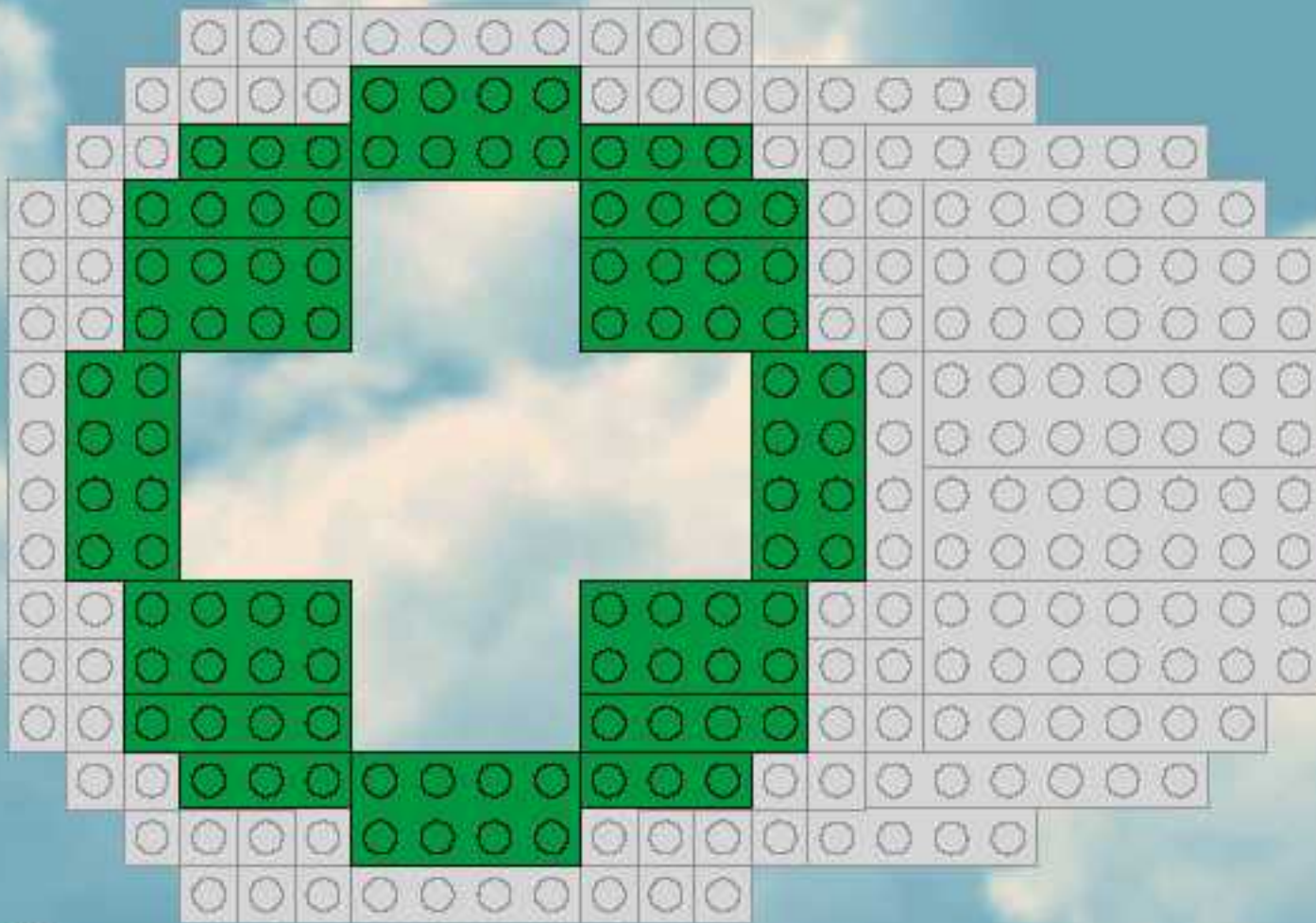

16

6x



4x



17

4x



2x



2x



4x



2x

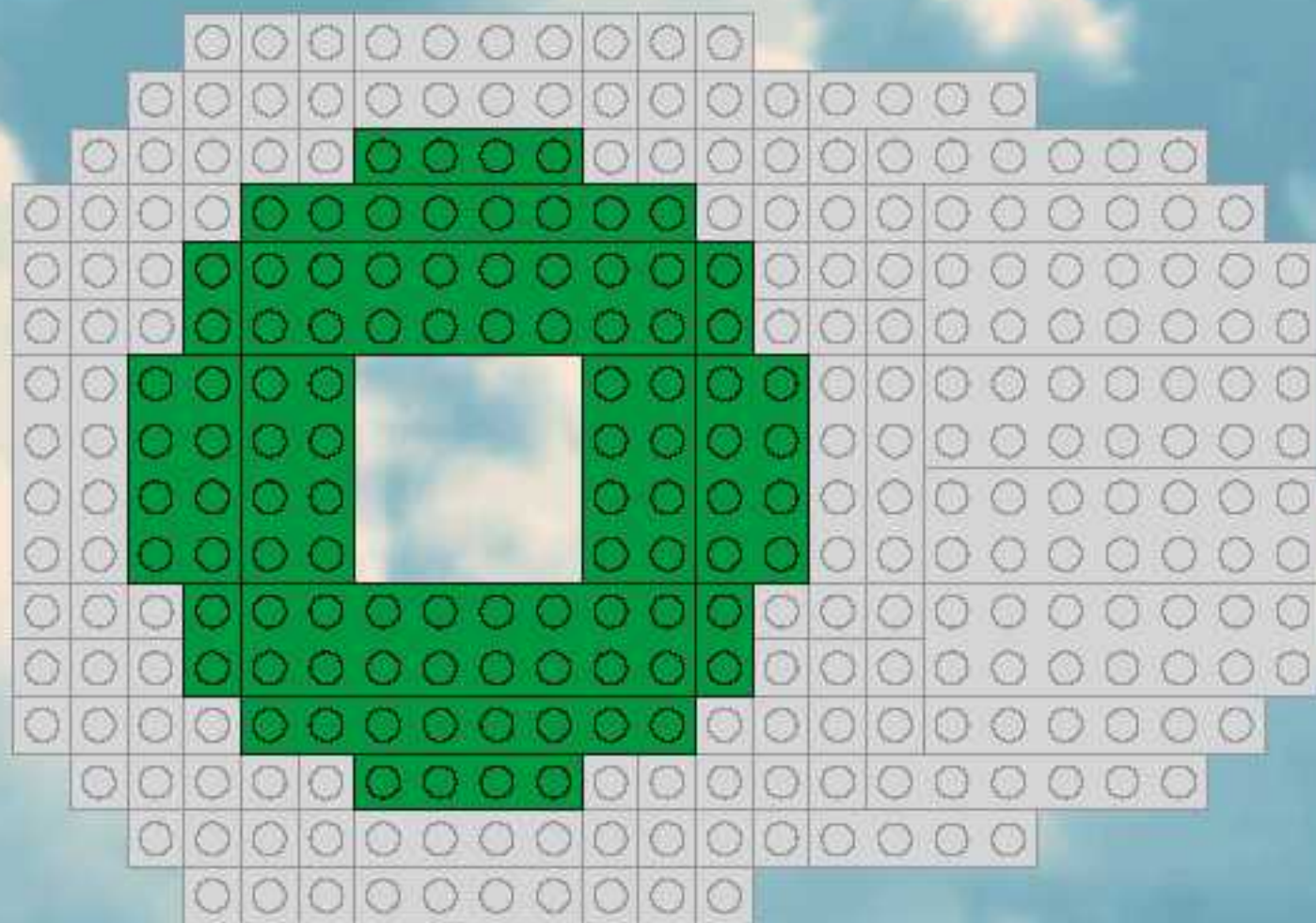
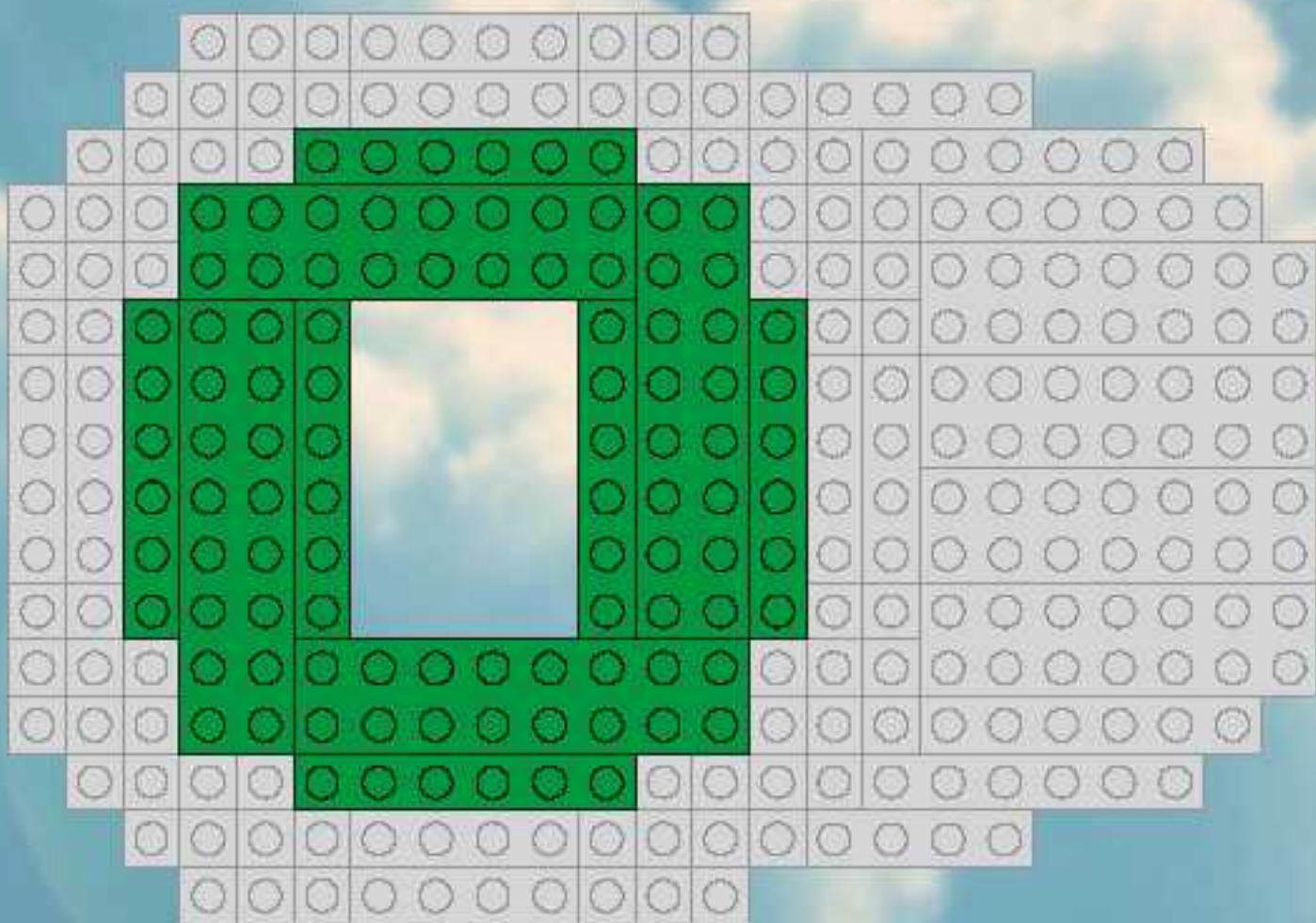

18

4x 

4x 

2x 

1x 

3x 

19

2x 

2x 

2x 

4x 

2x 

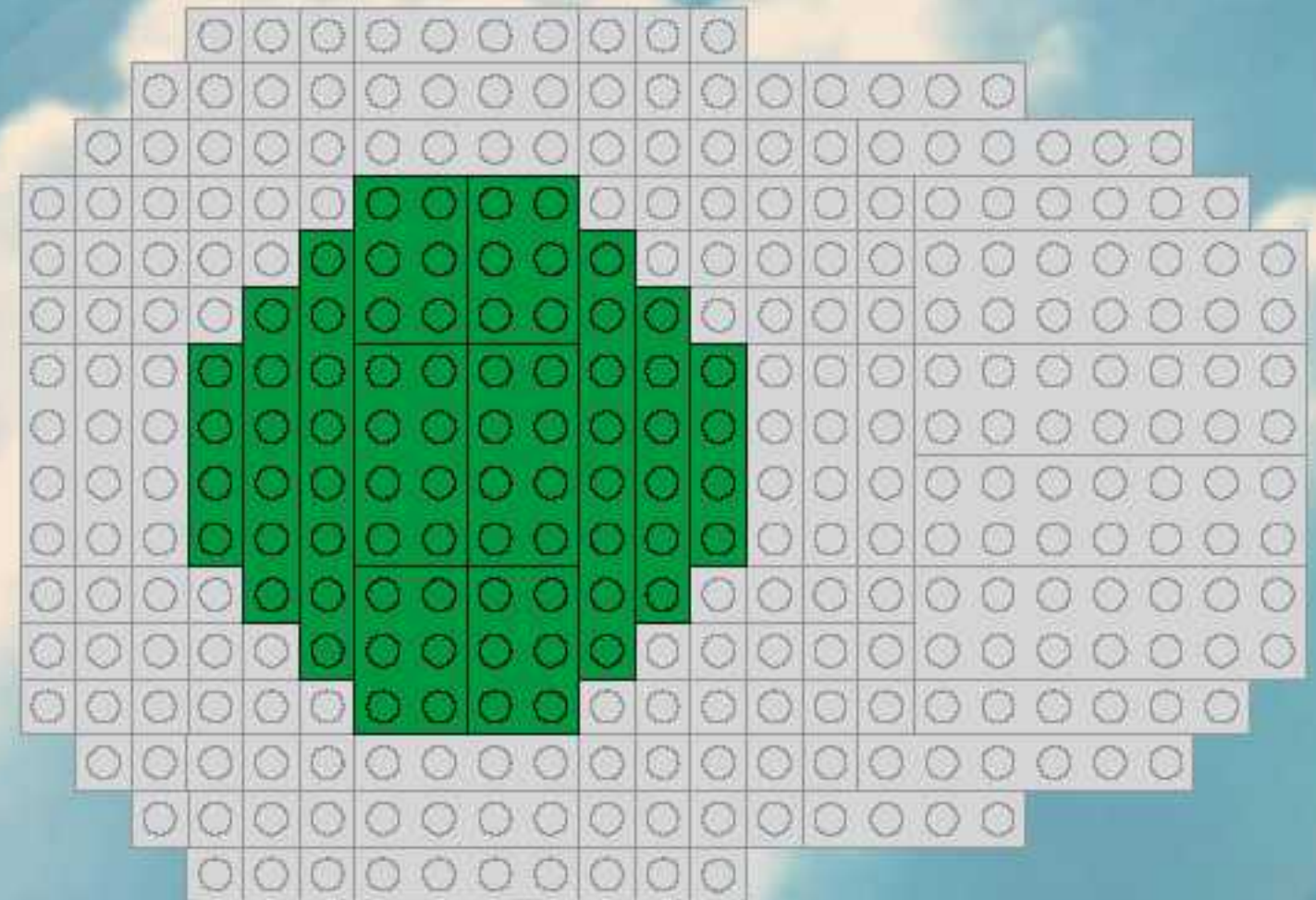
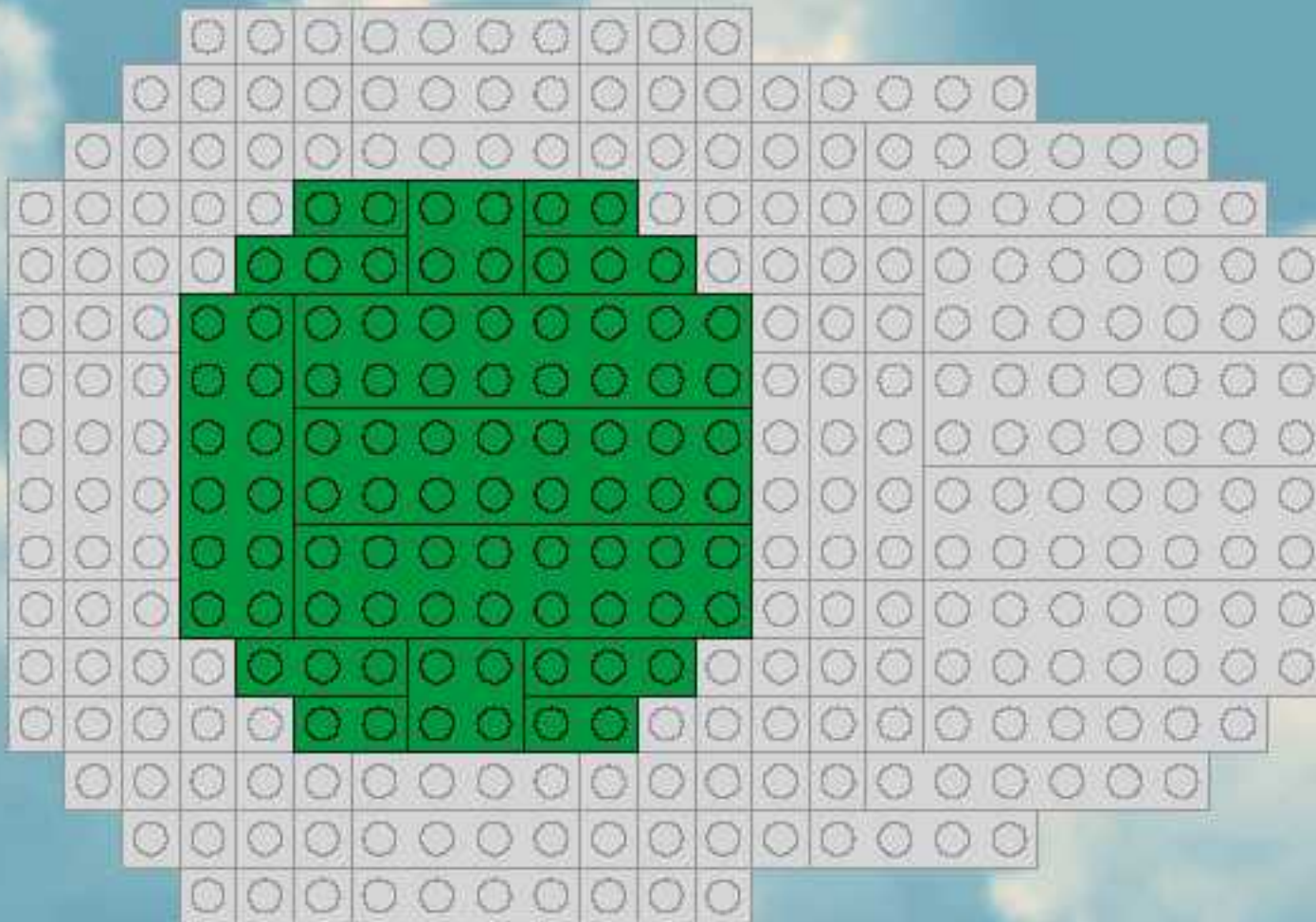

20

2x 

2x 

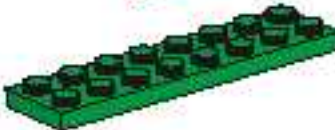
2x 

21

2x 

2x 

1x 

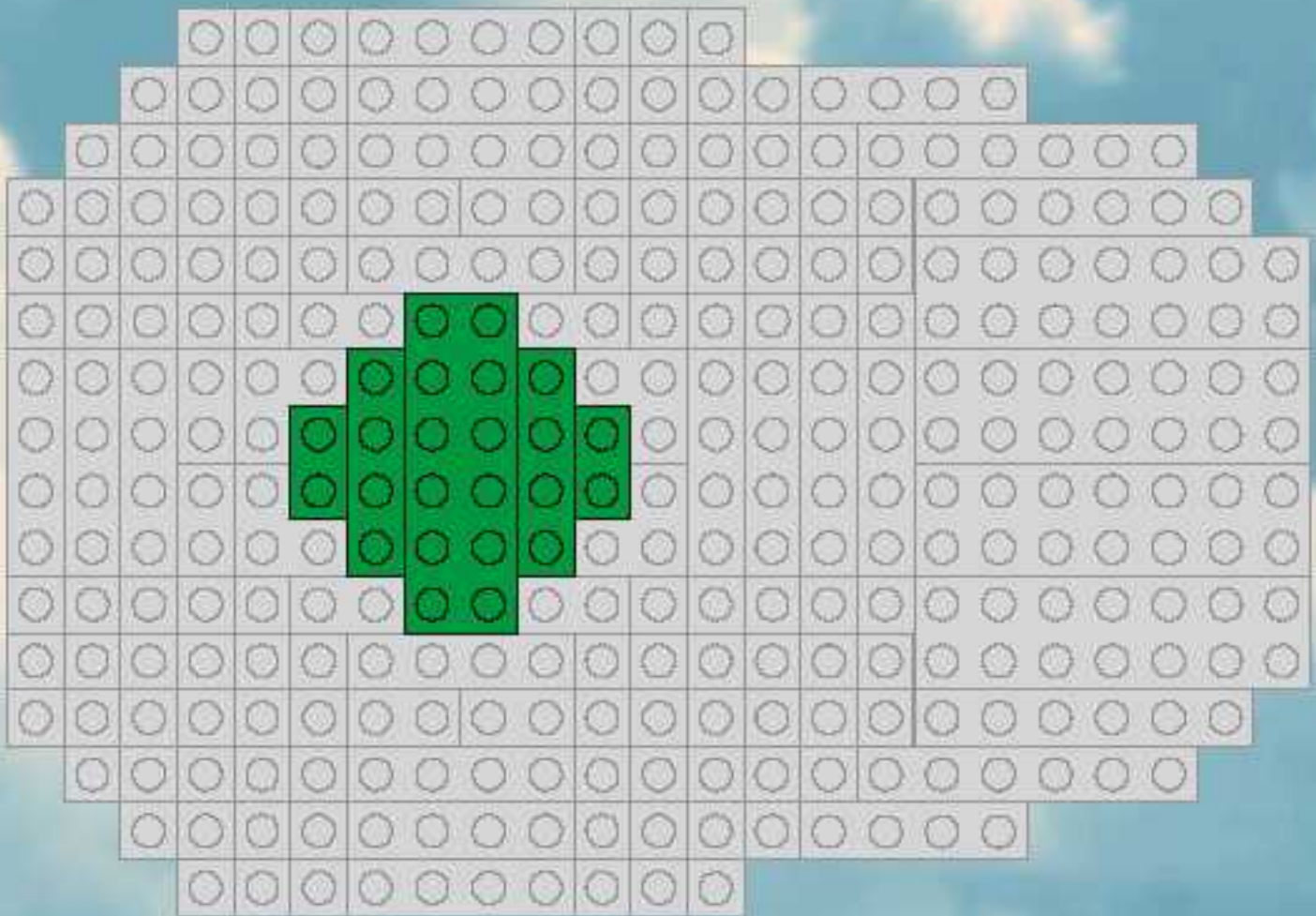
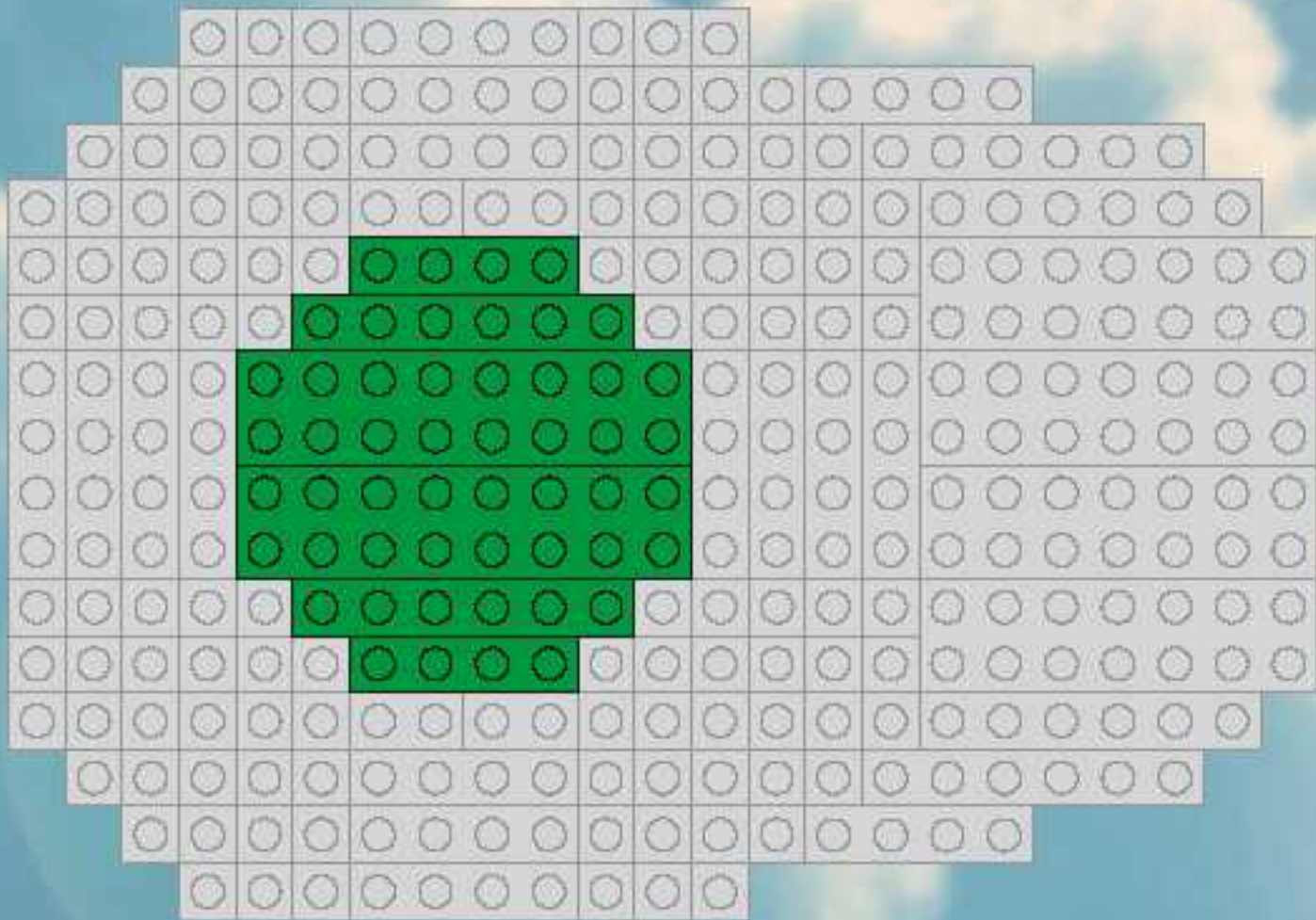

22

2x



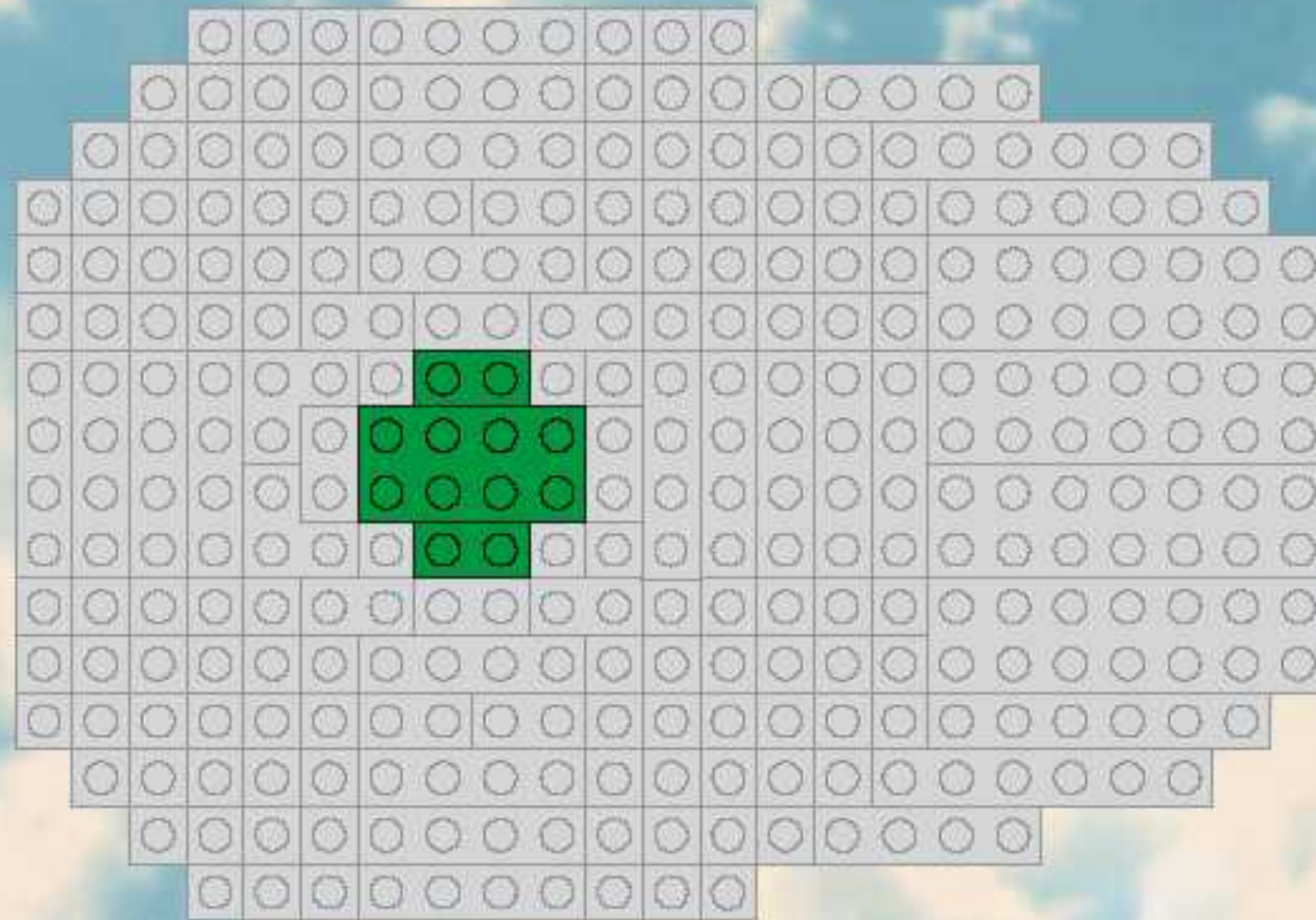

1x

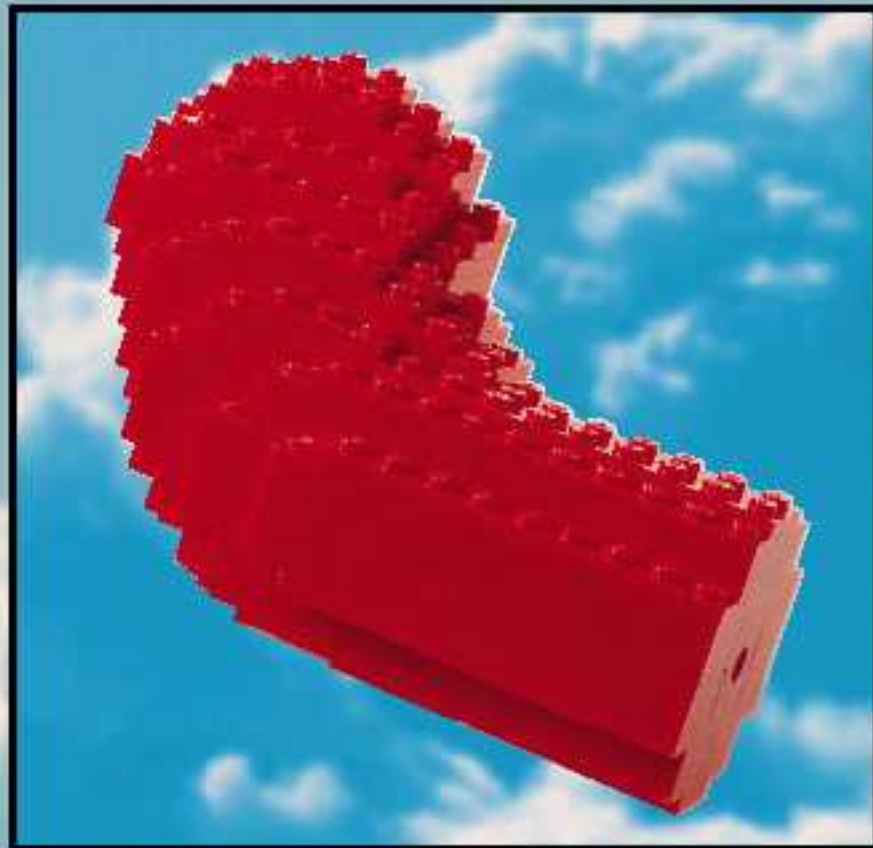



1

1x 

1x 

1x 

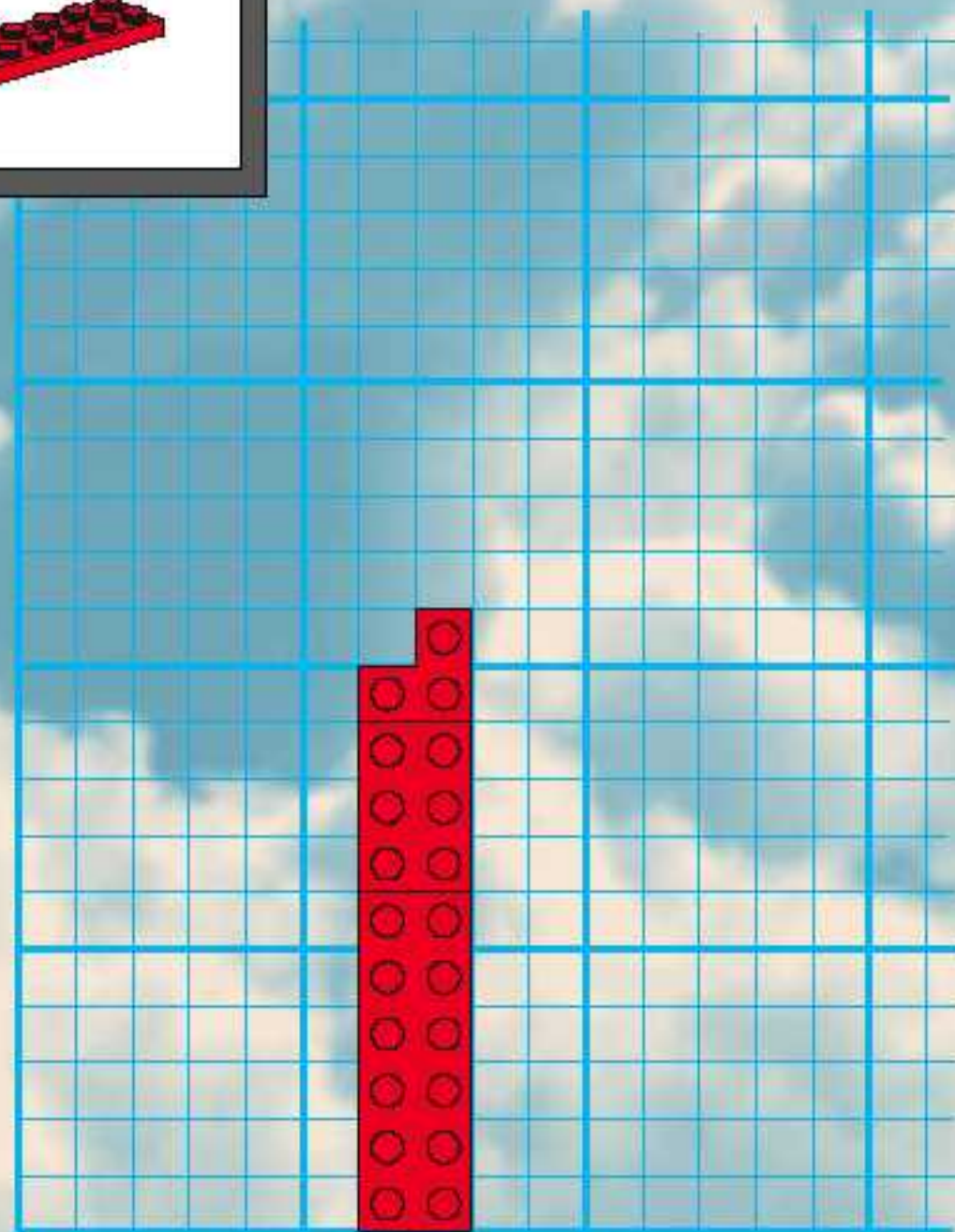

2

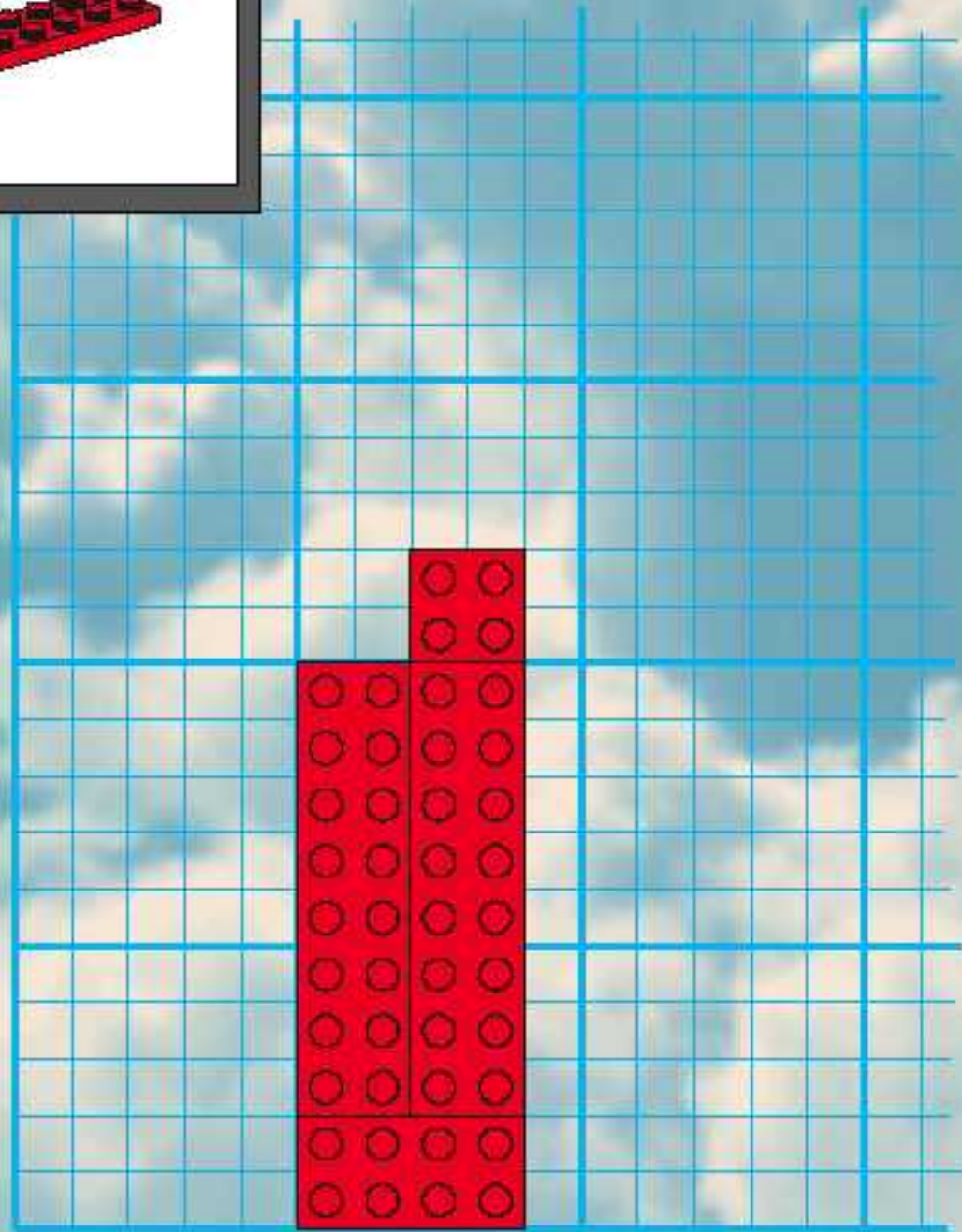

3

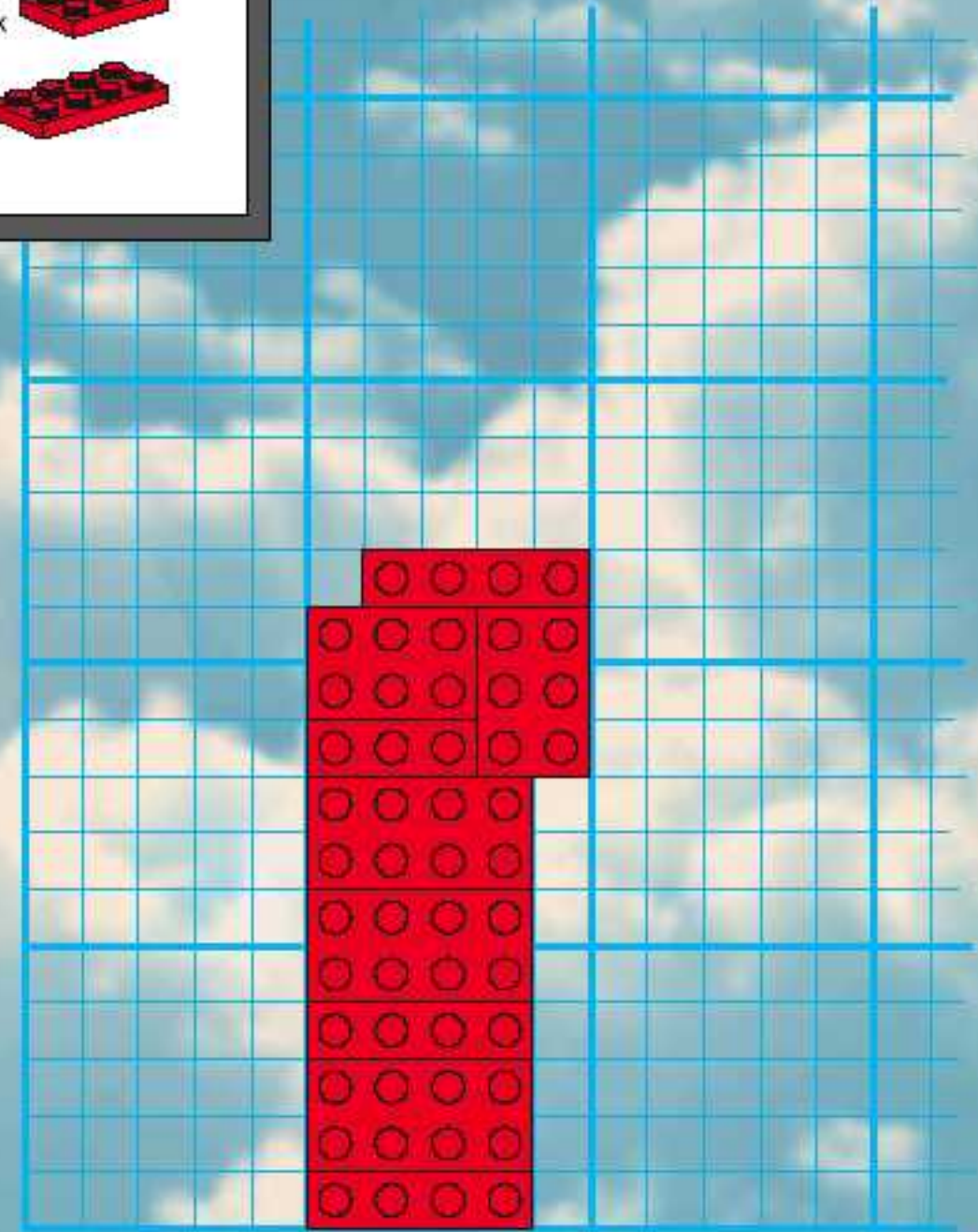

4

1x 

1x 

3x 

2x 

1x 

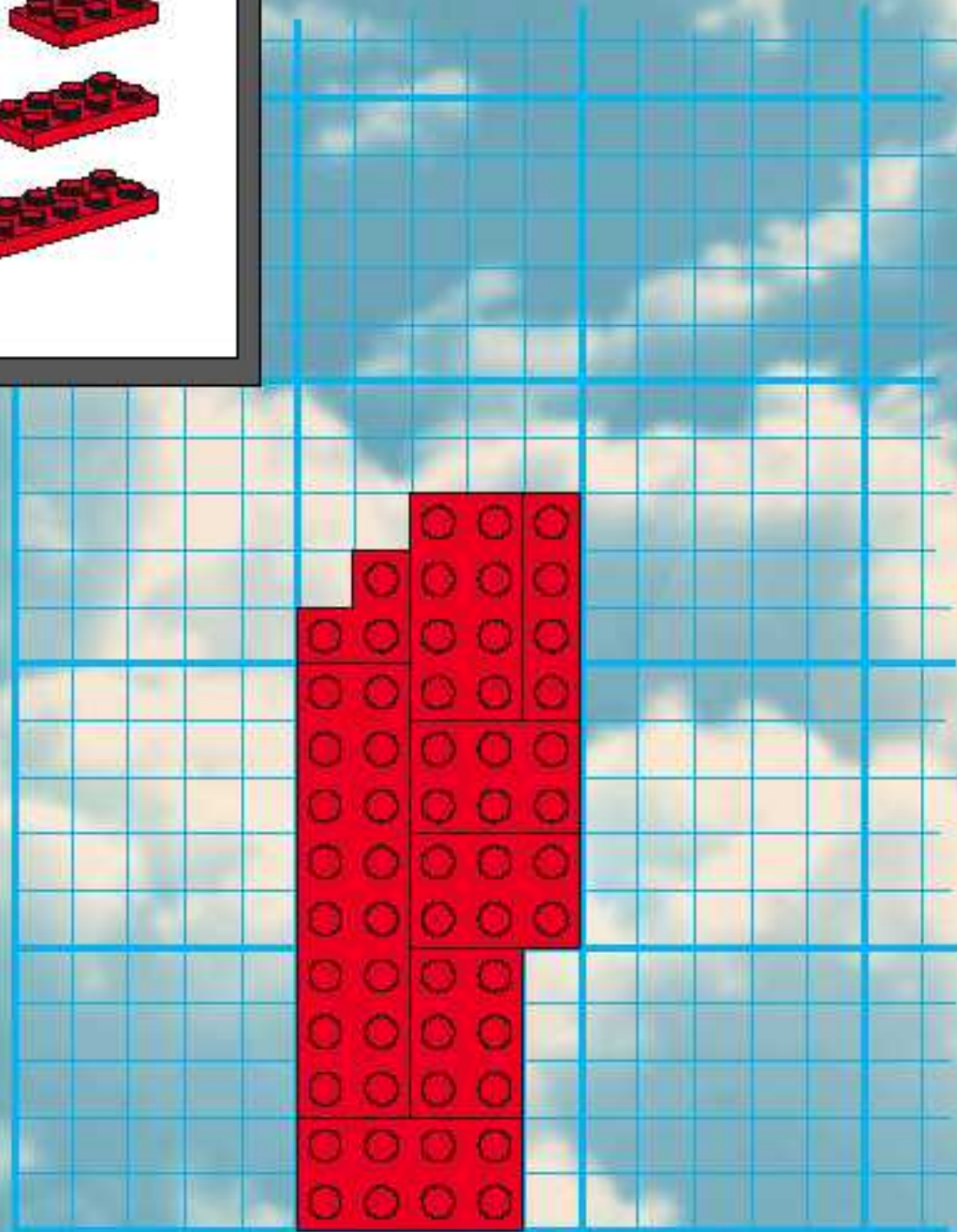

5

3x 

1x 

4x 

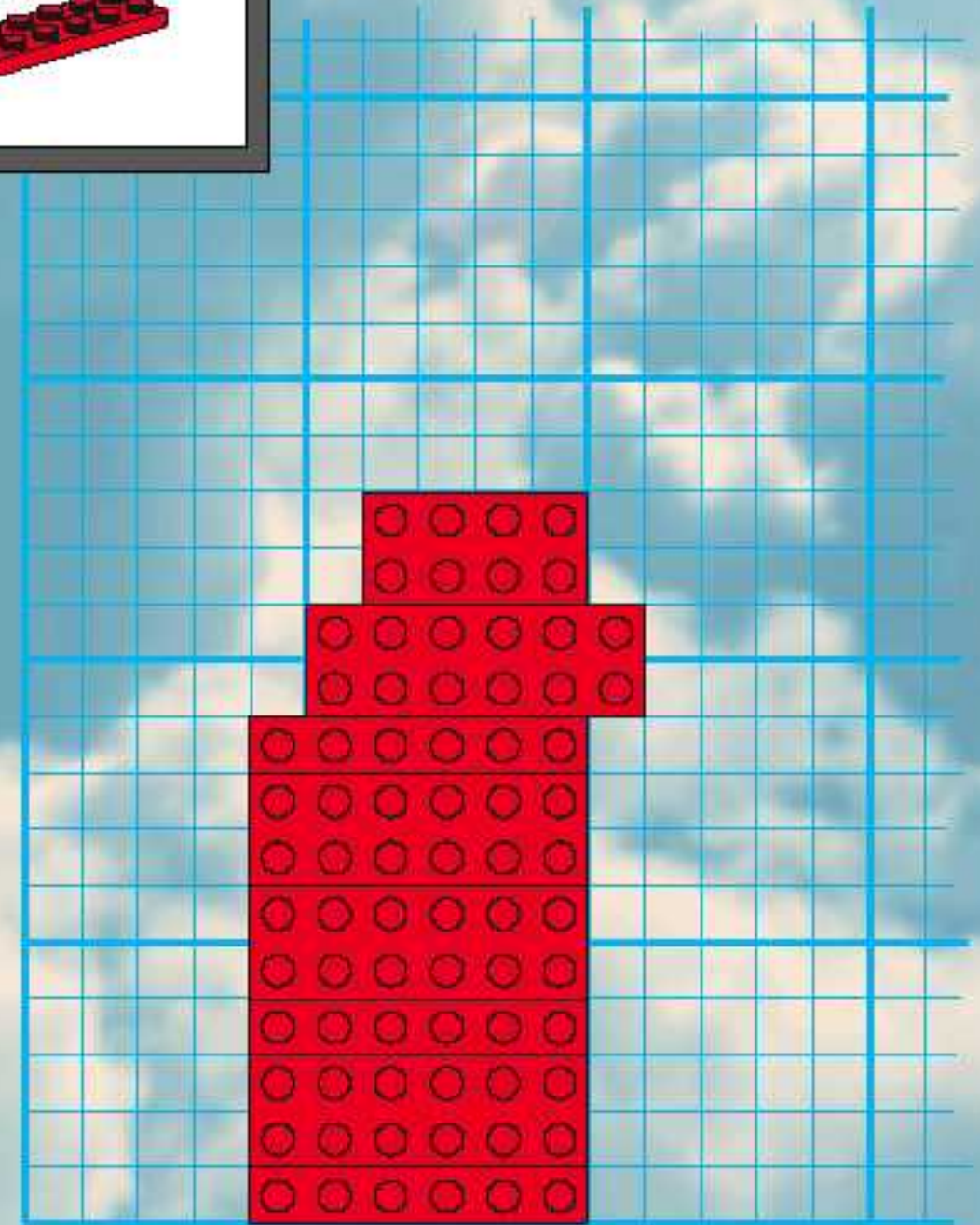

6

1x 

1x 

1x 

2x 







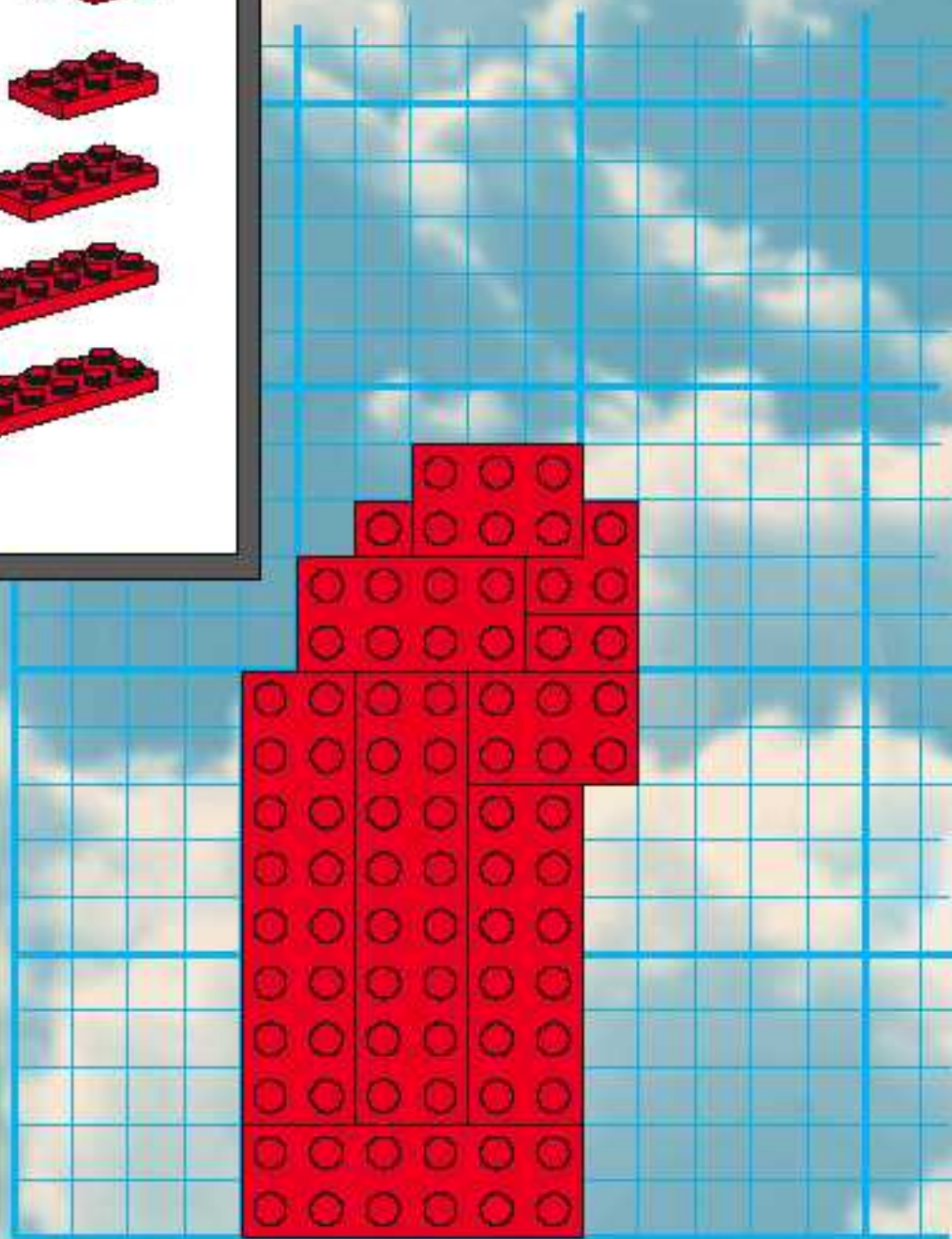





1x 

2x 

2x 



7

- 2x 
- 4x 
- 1x 
- 1x 
- 1x 
- 1x 
- 5x 
- 2x 
- 5x 
- 2x 
- 2x 
- 1x 

1

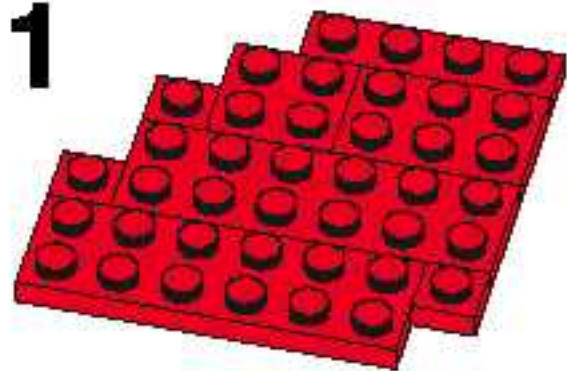

2

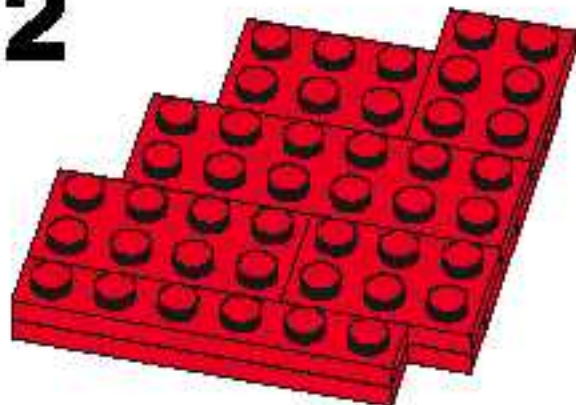

3

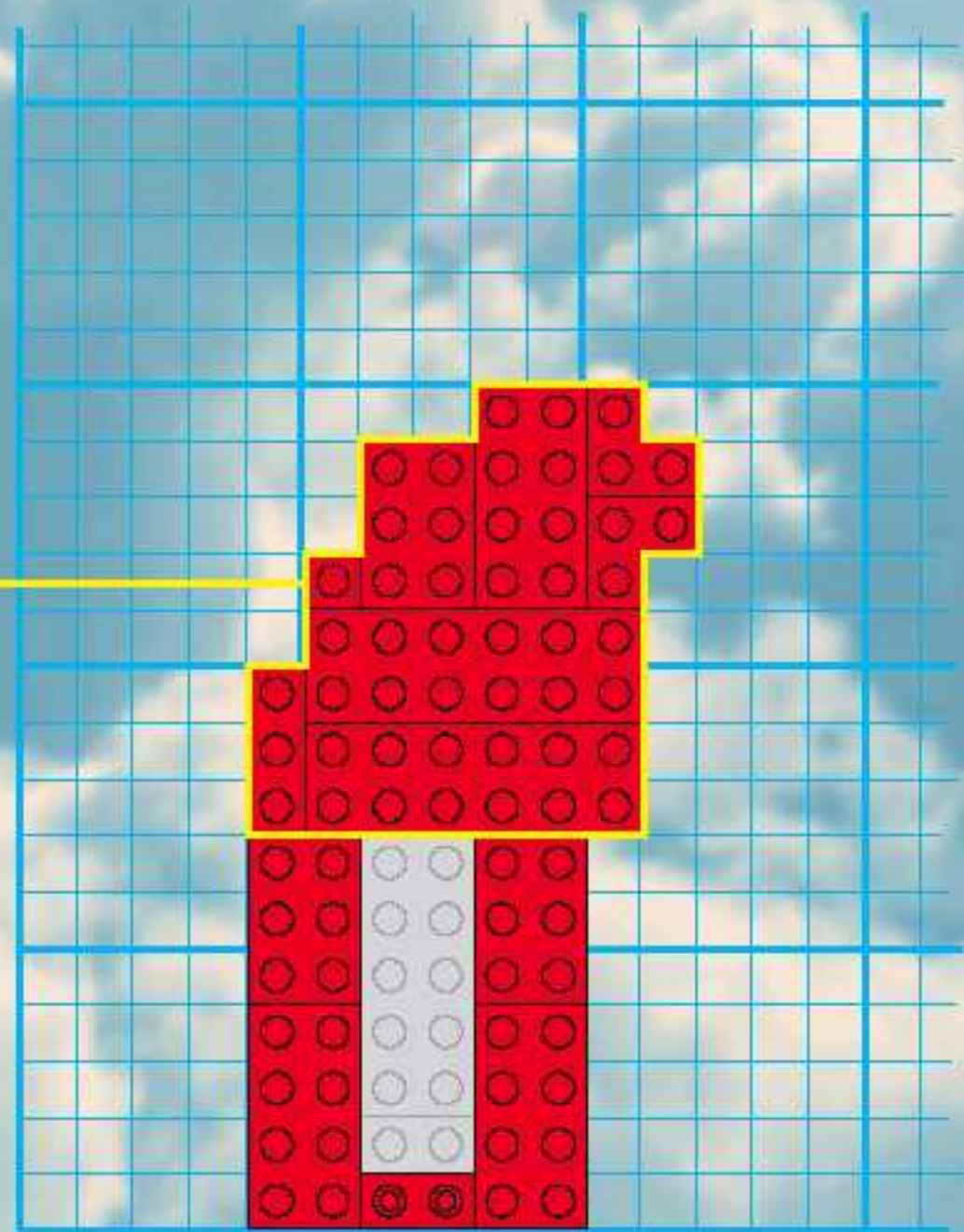
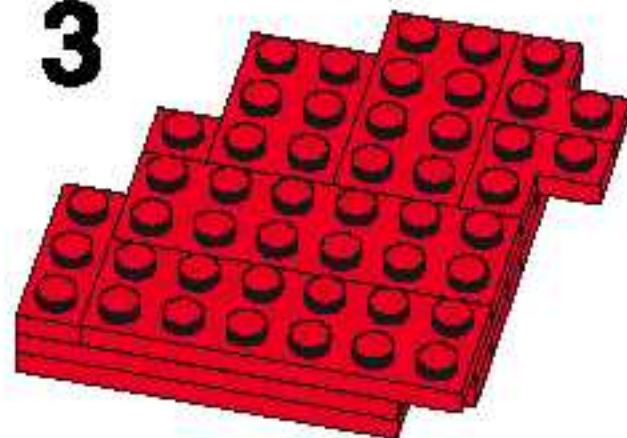

8

- 3x
- 3x
- 2x
- 2x
- 3x
- 3x
- 3x
- 3x
- 1x
- 1x
- 3x

1



2

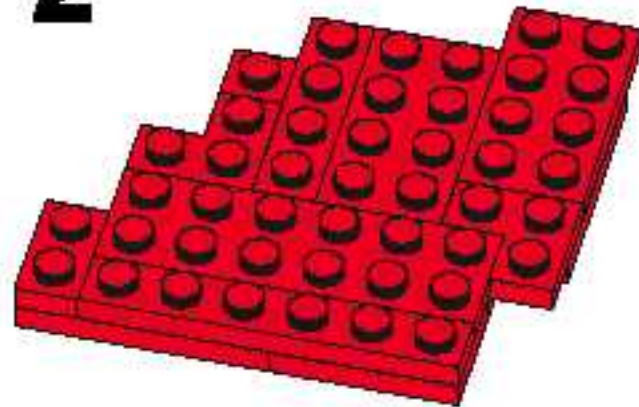

3

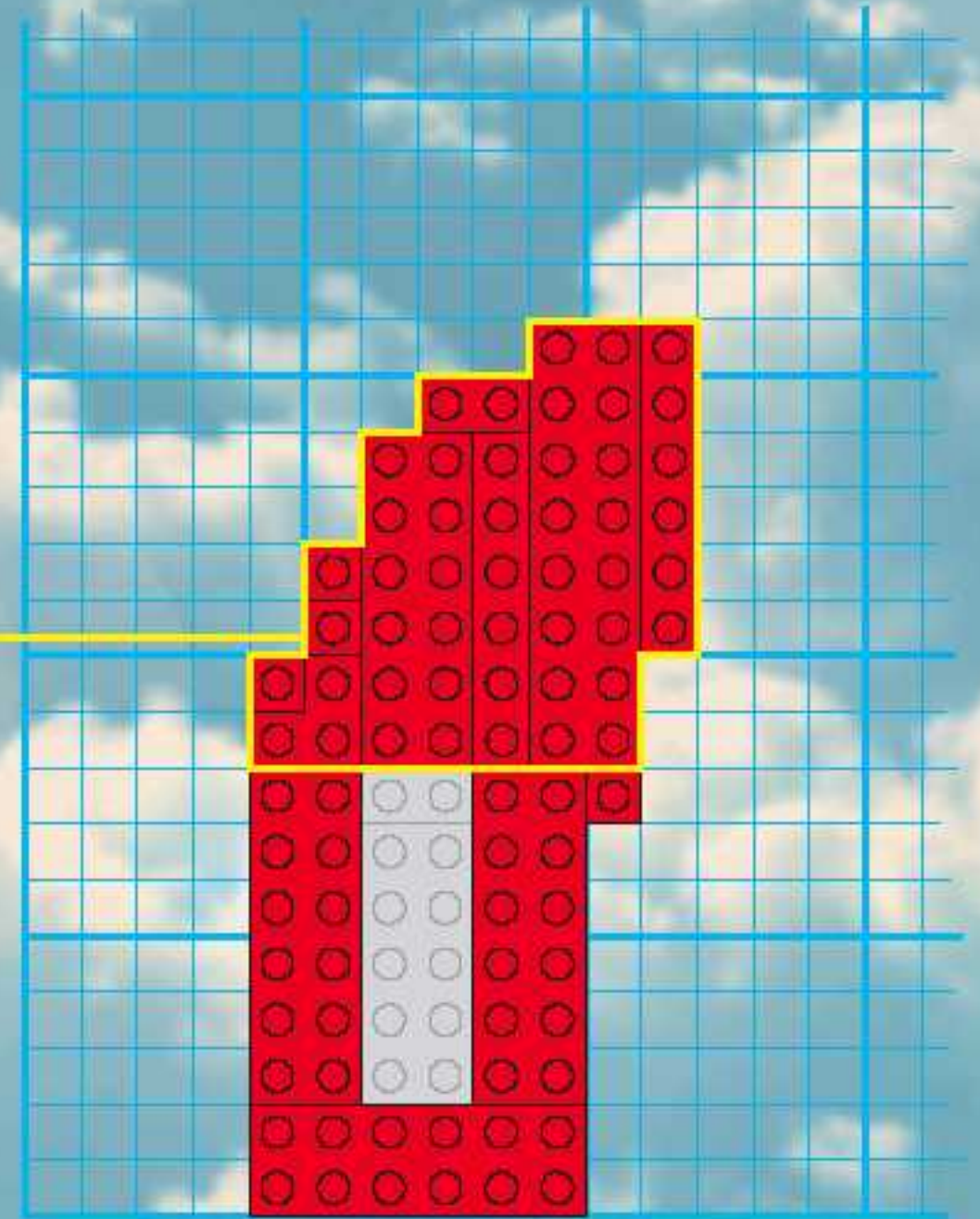
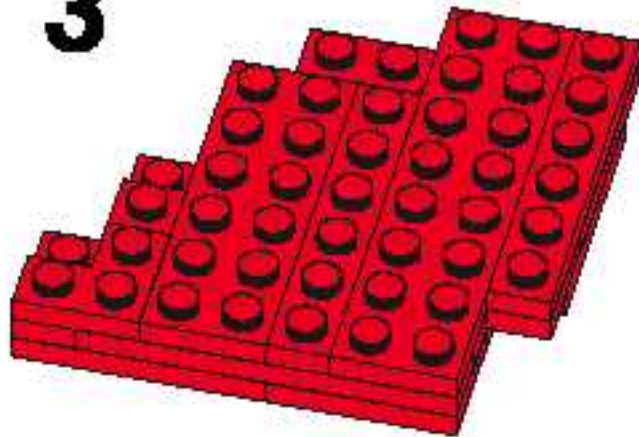

9



1

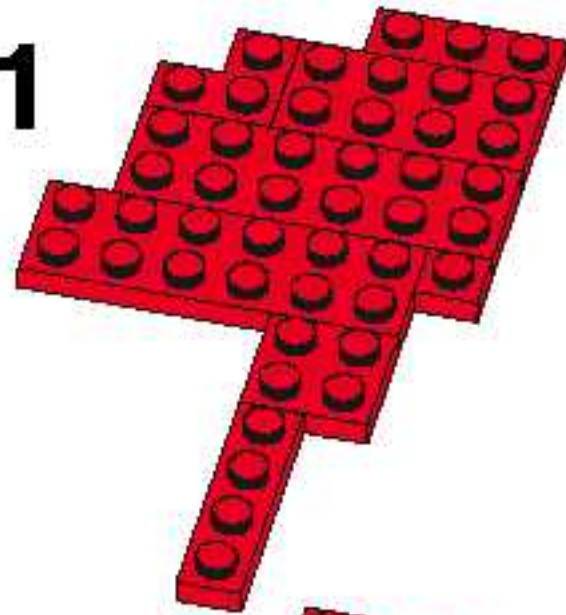



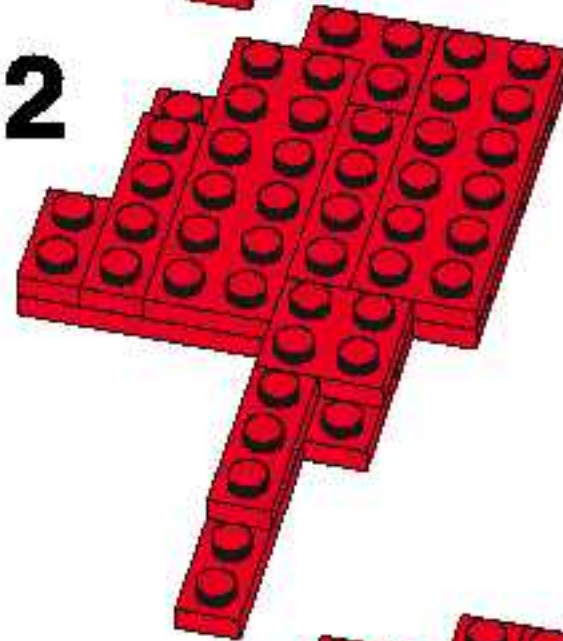



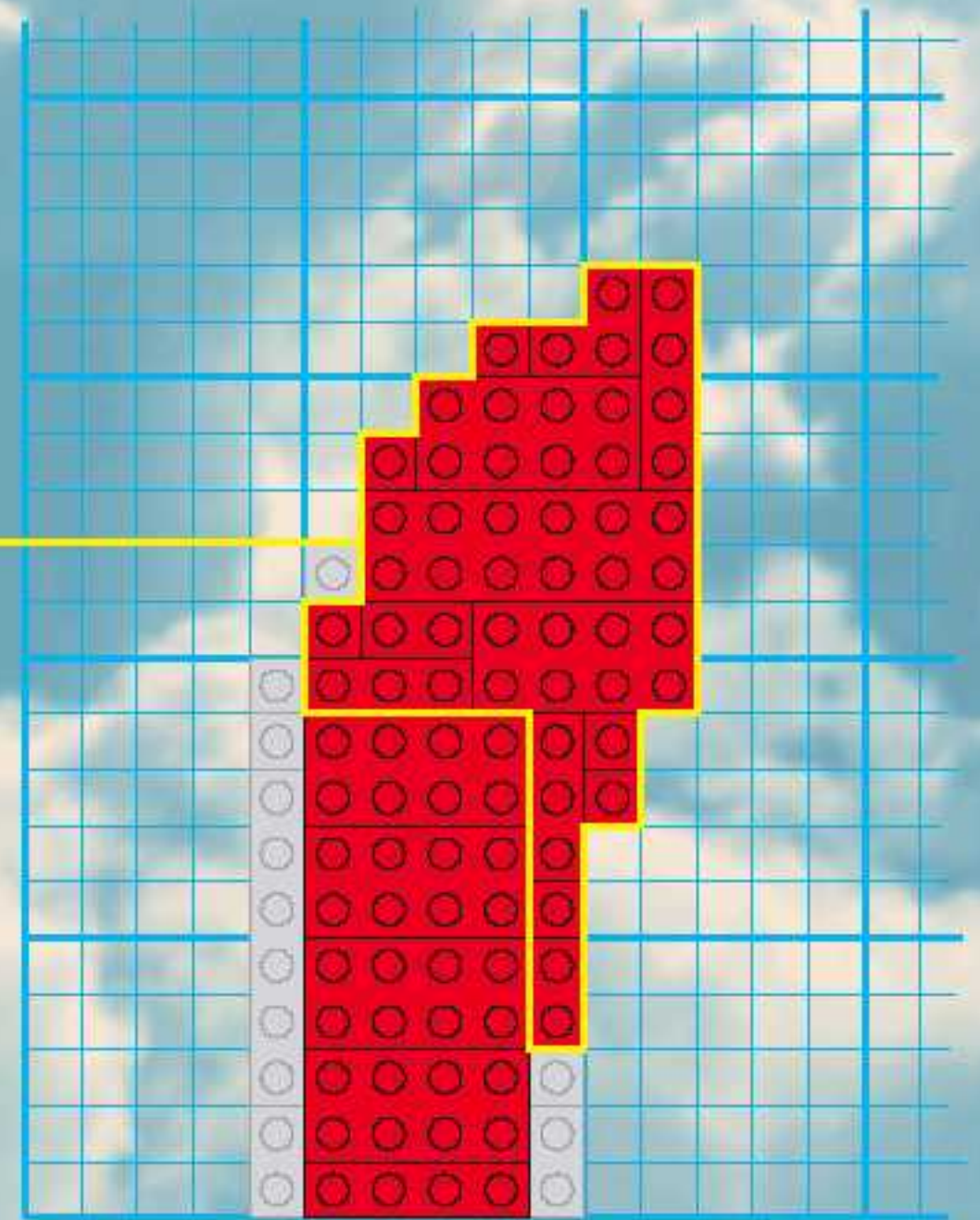
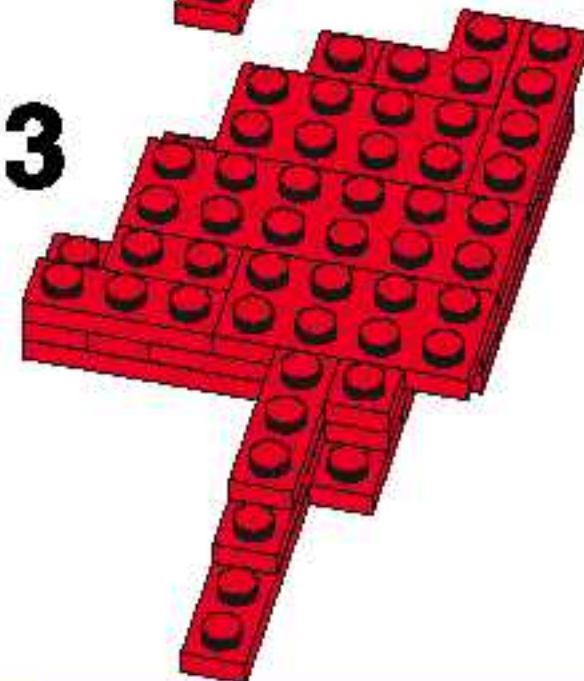

2



3







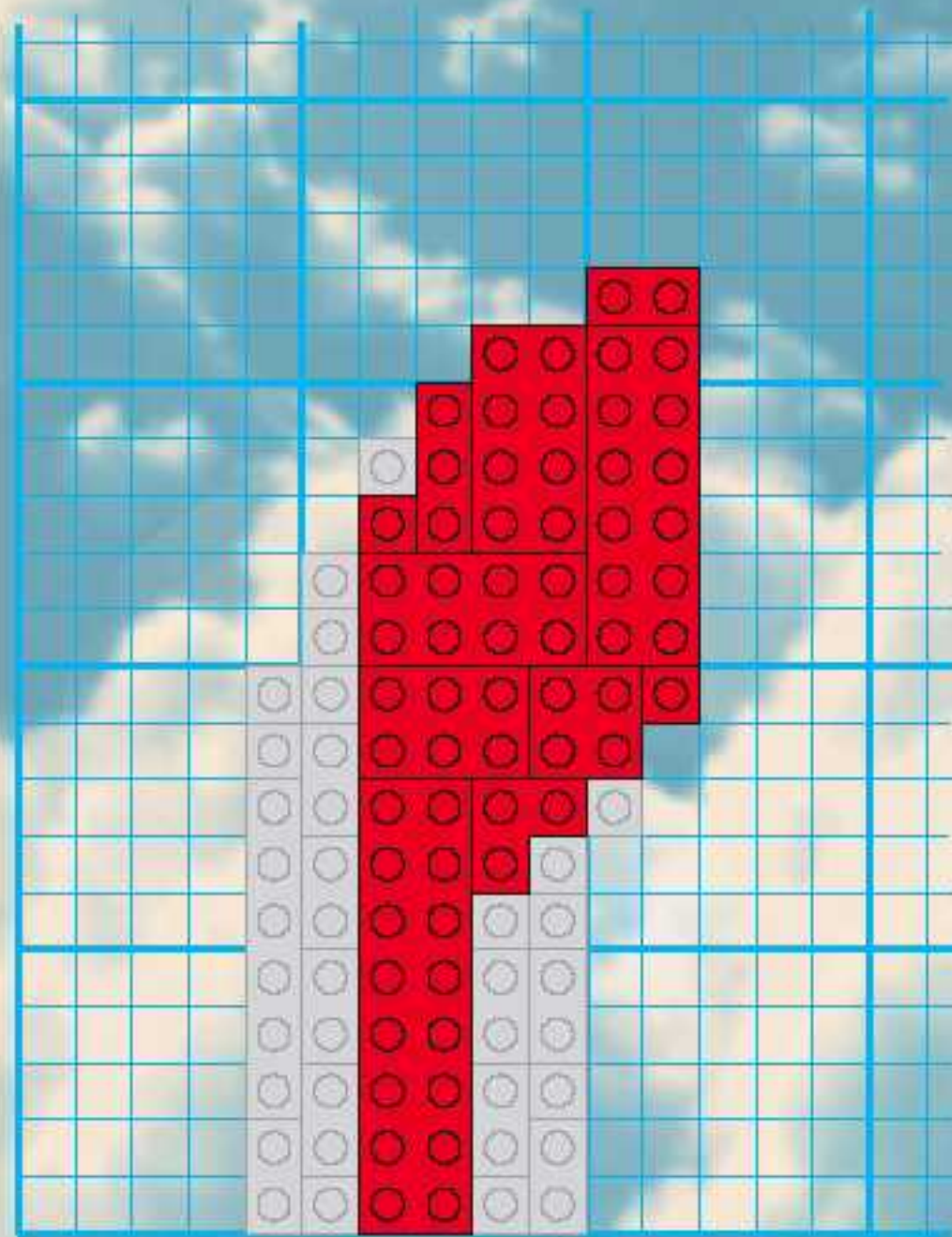







10

- 1x 
- 2x 
- 1x 
- 1x 
- 1x 
- 1x 
- 2x 
- 1x 
- 1x 



11

- 2x 
- 5x 
- 4x 
- 3x 
- 1x 
- 1x 
- 1x 
- 1x 
- 1x 
- 1x 
- 1x 
- 1x 
- 1x 

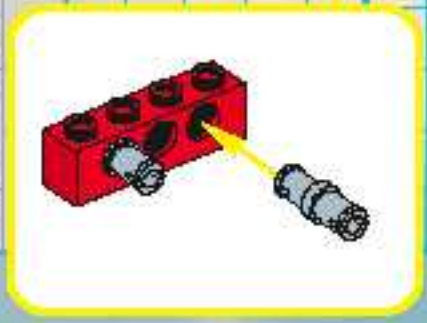
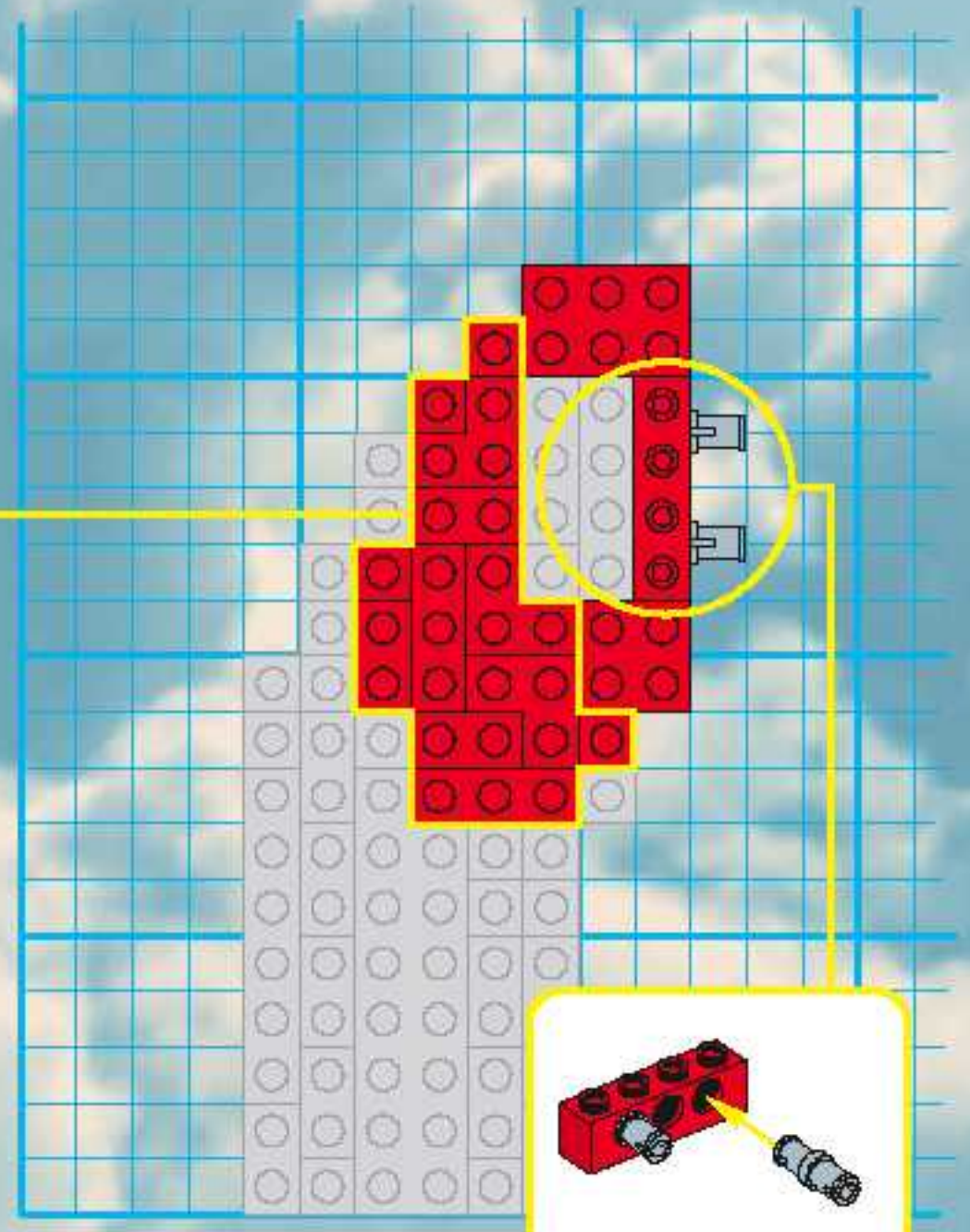
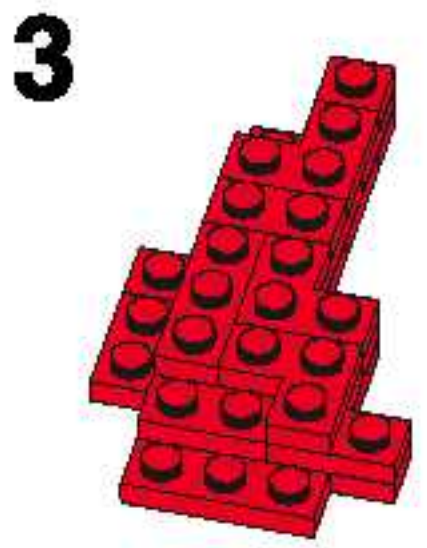
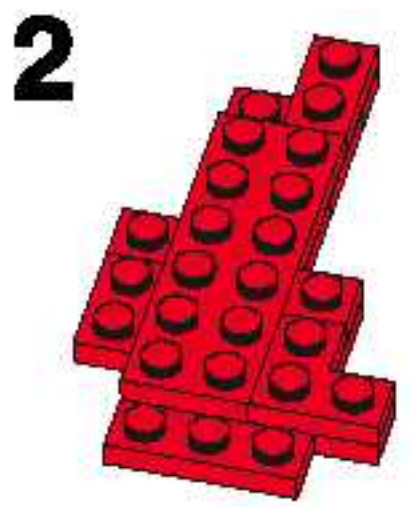
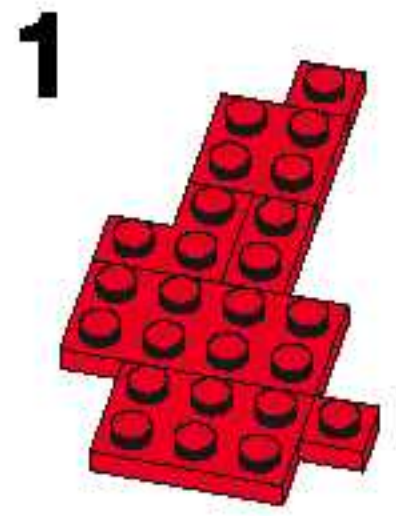

12

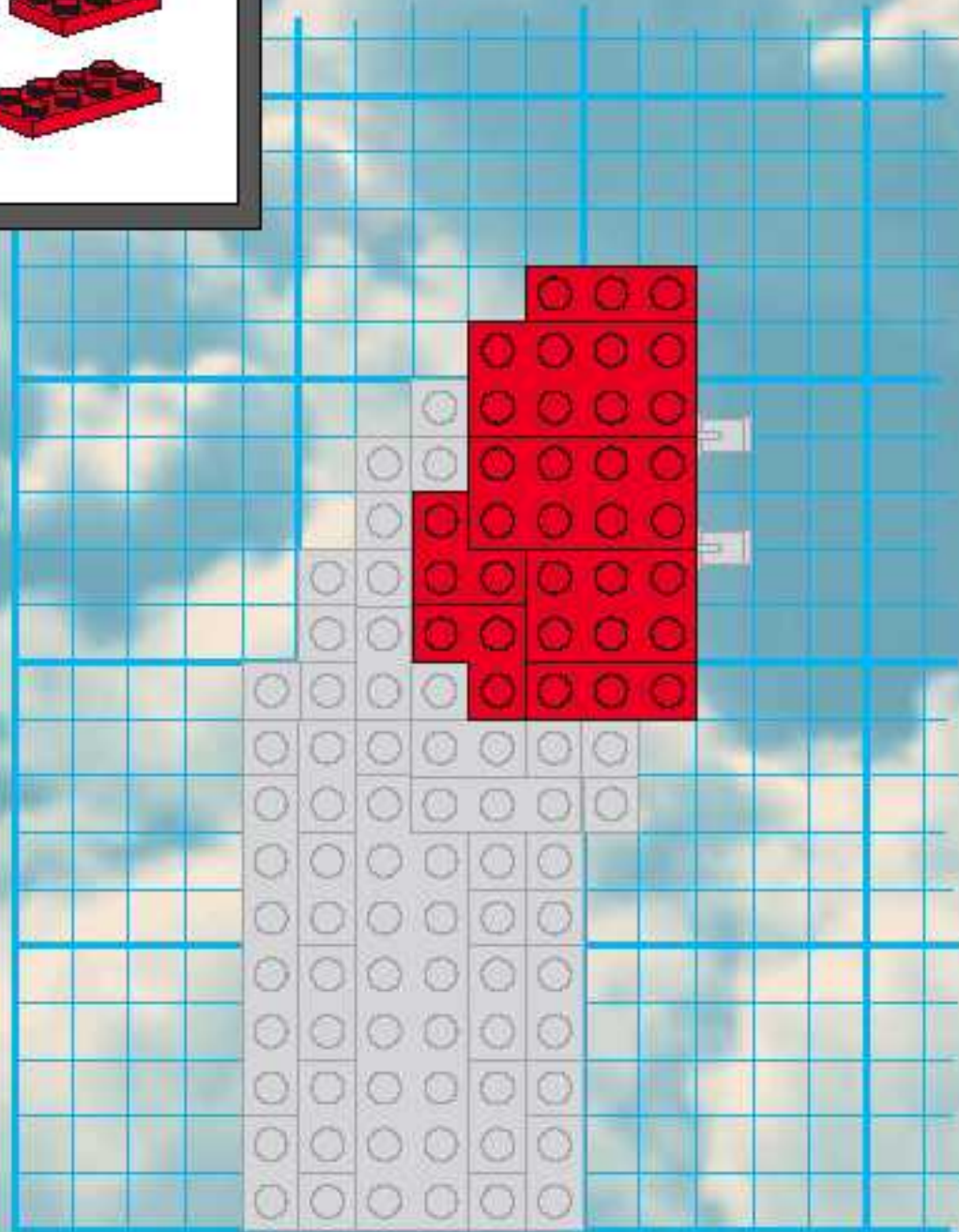

13

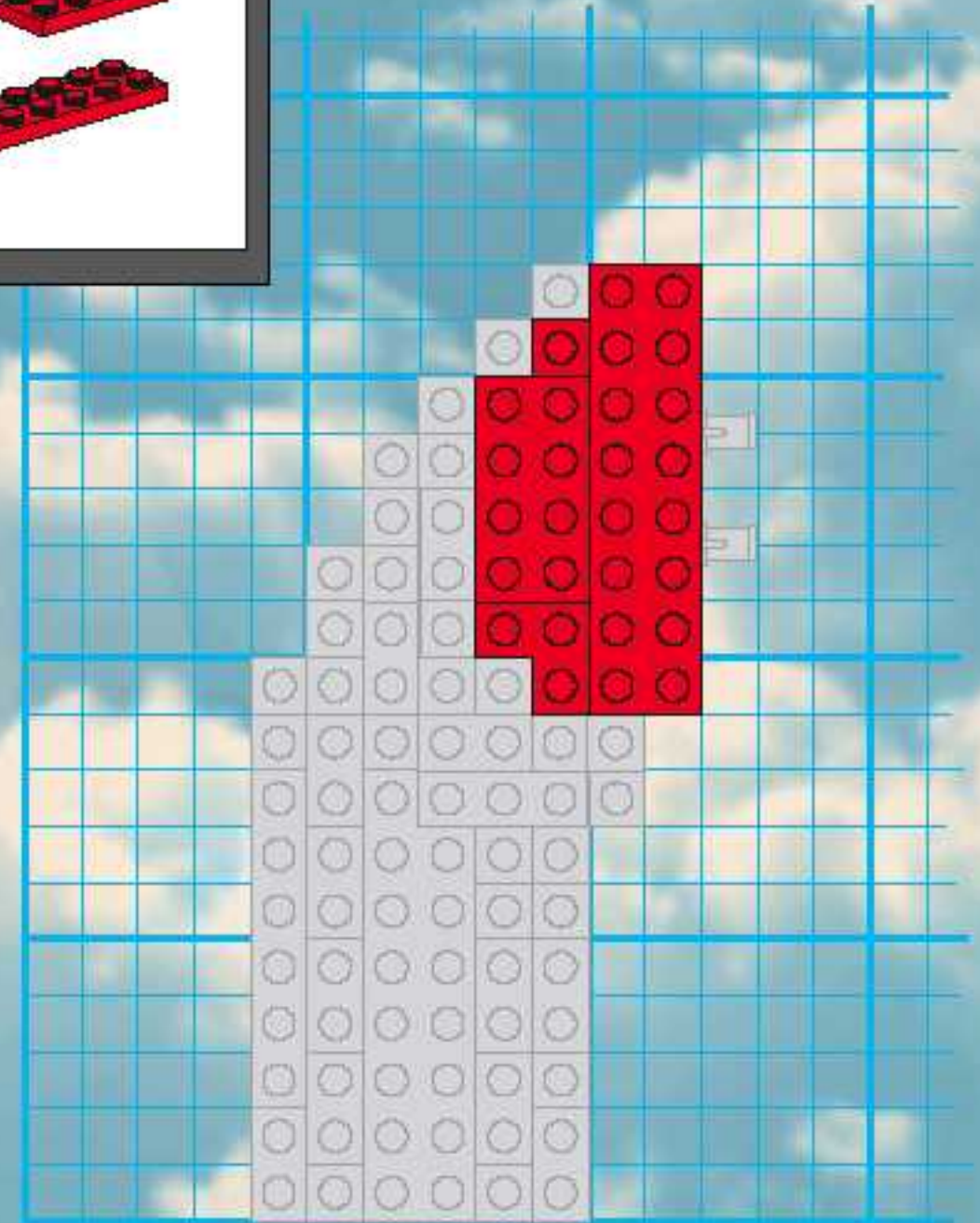

14

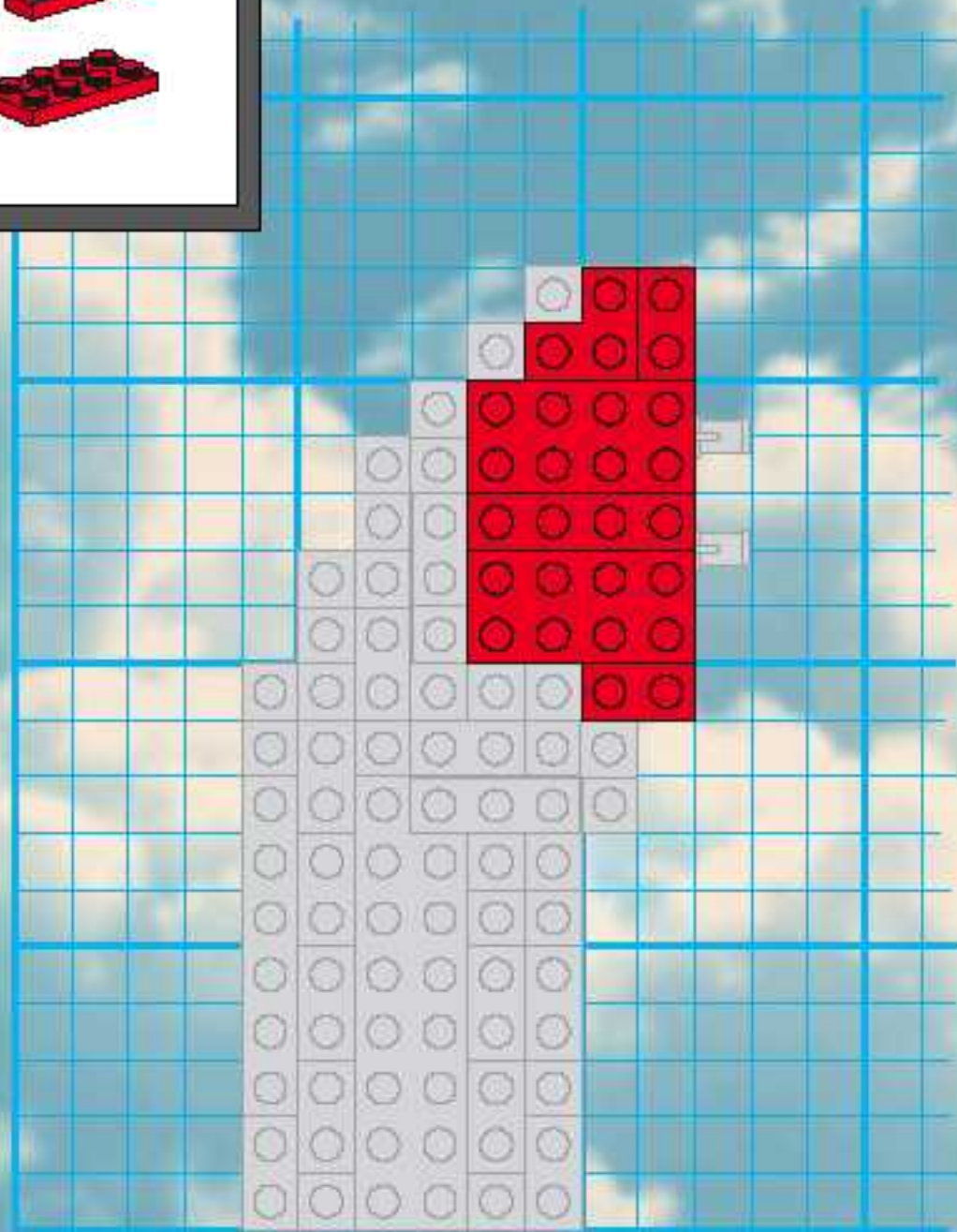

15

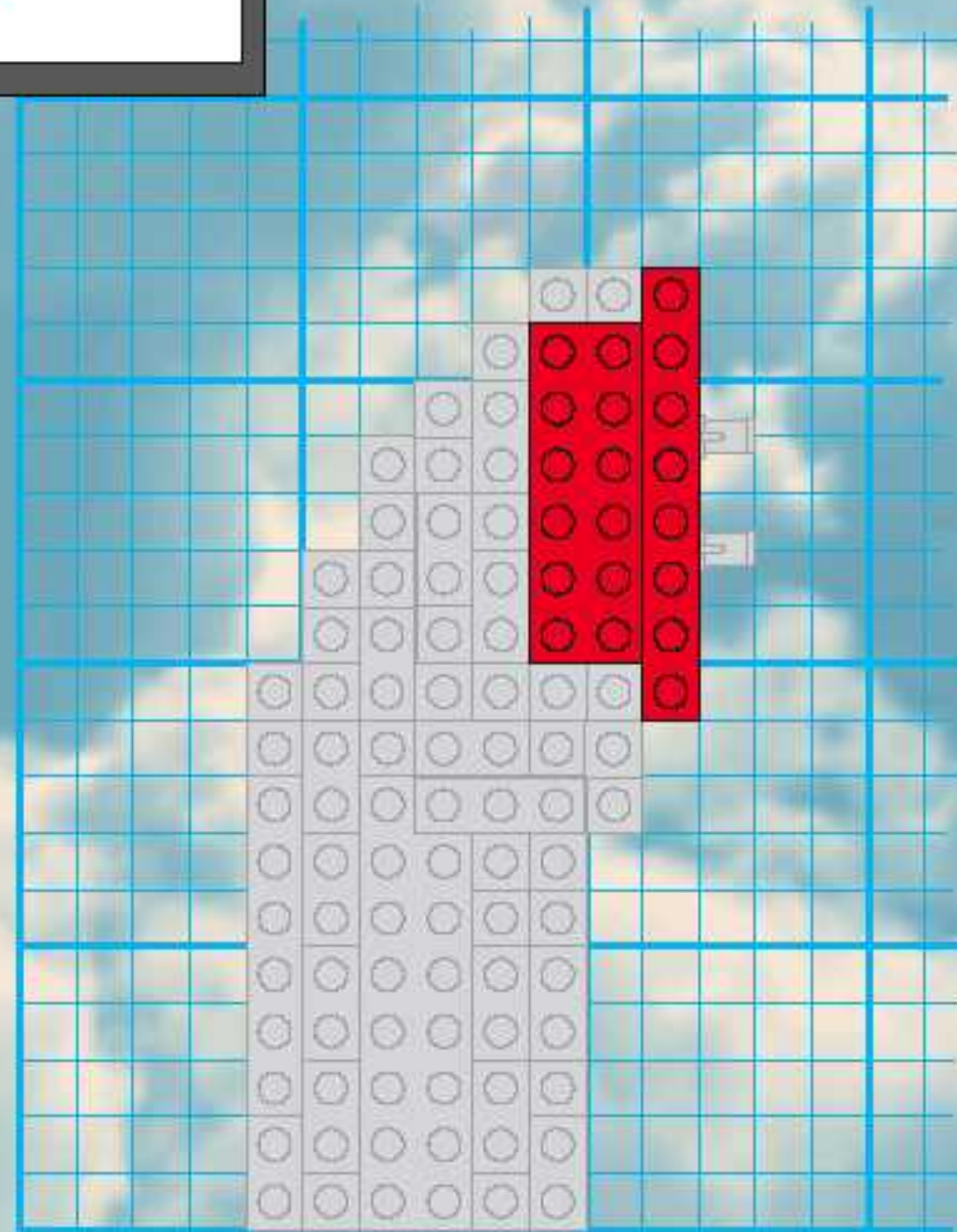

16

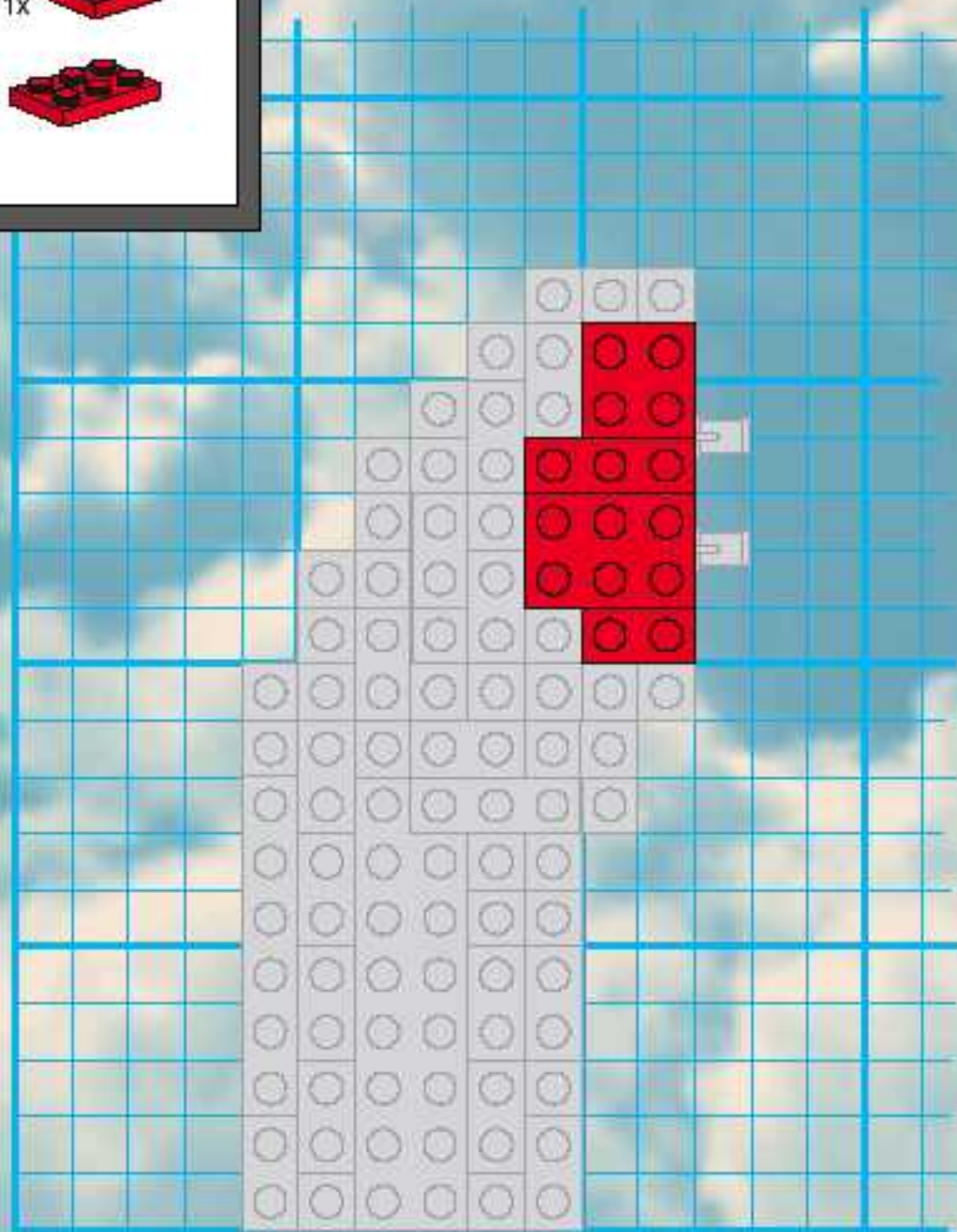

17

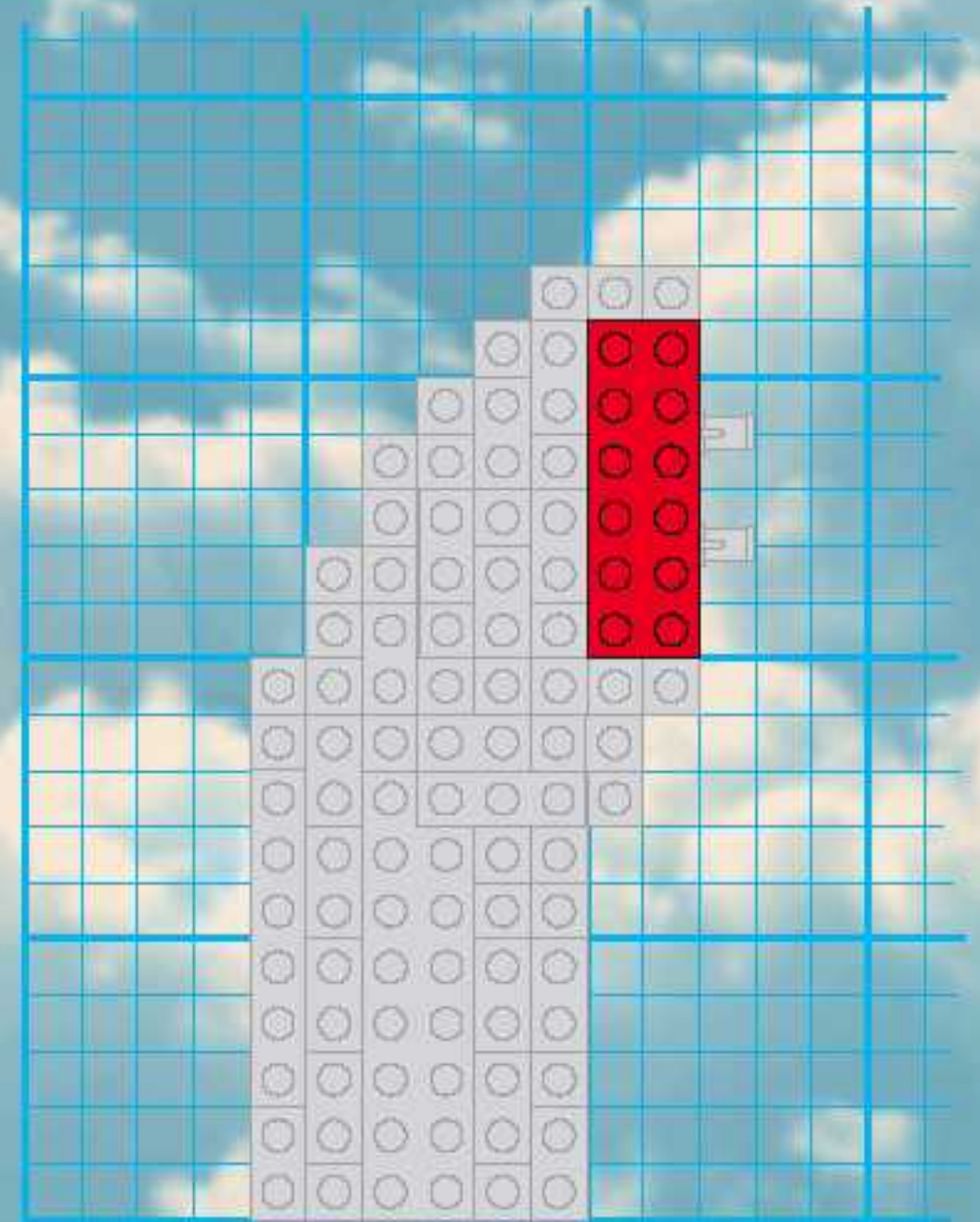

18

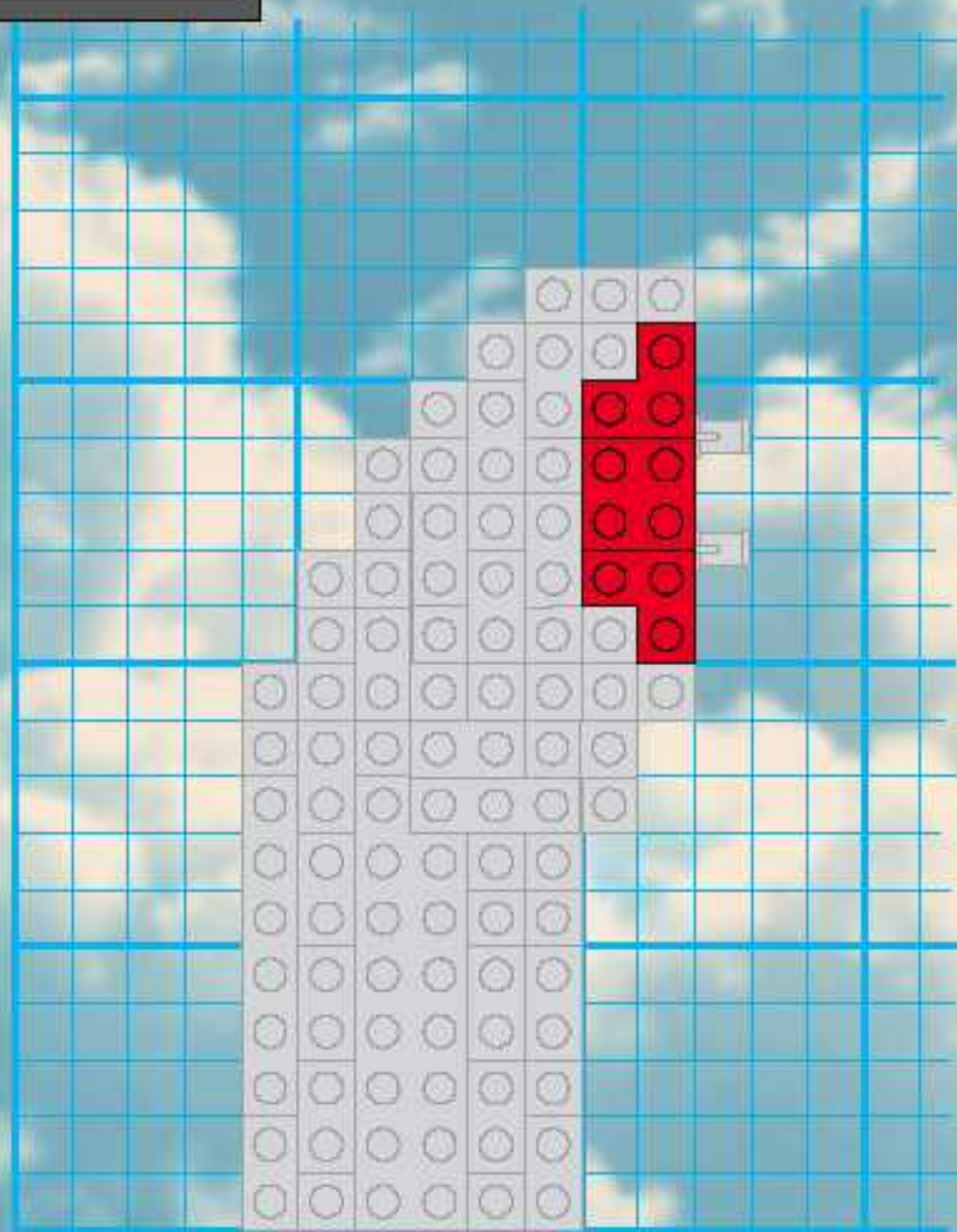

19

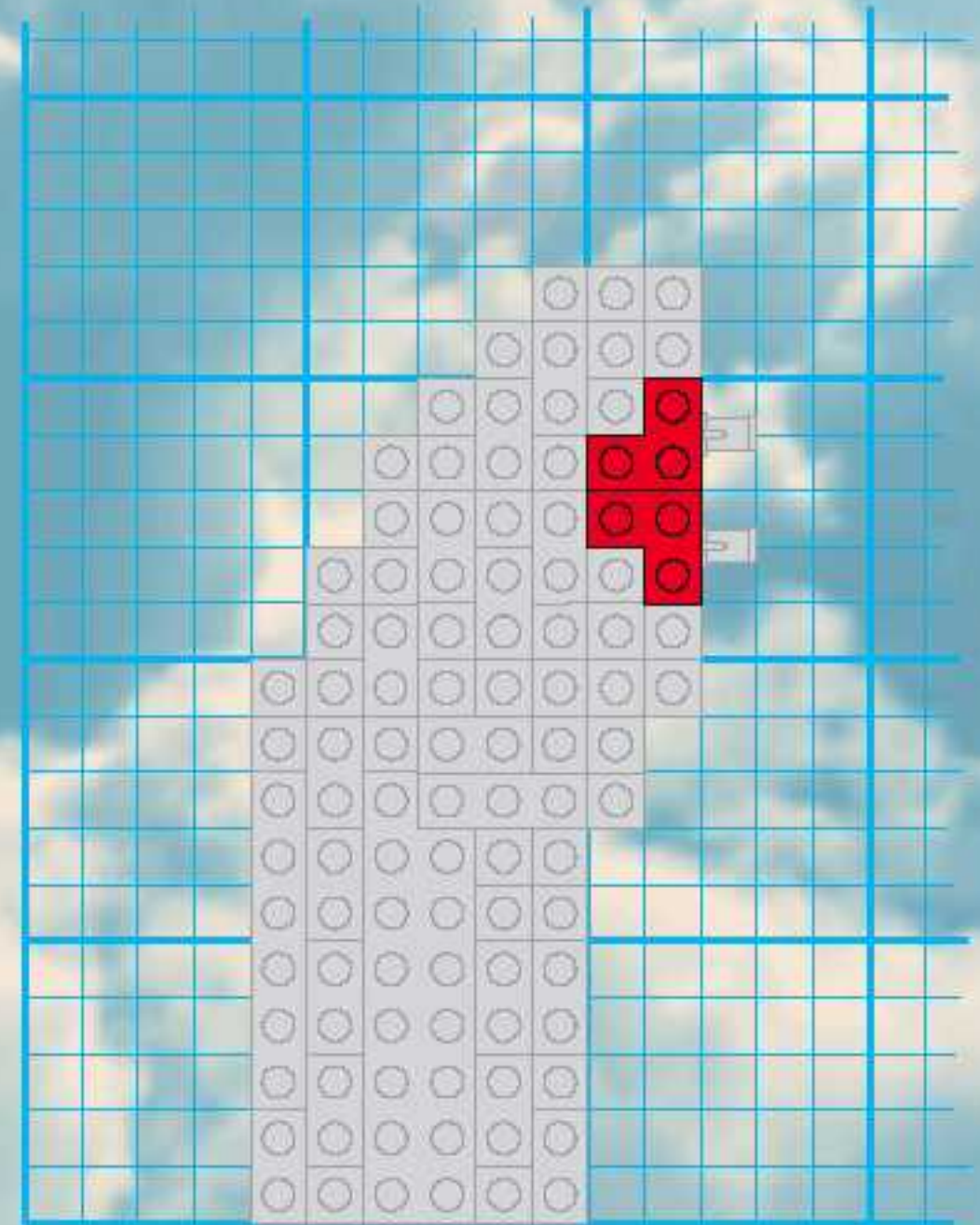

20

1x 

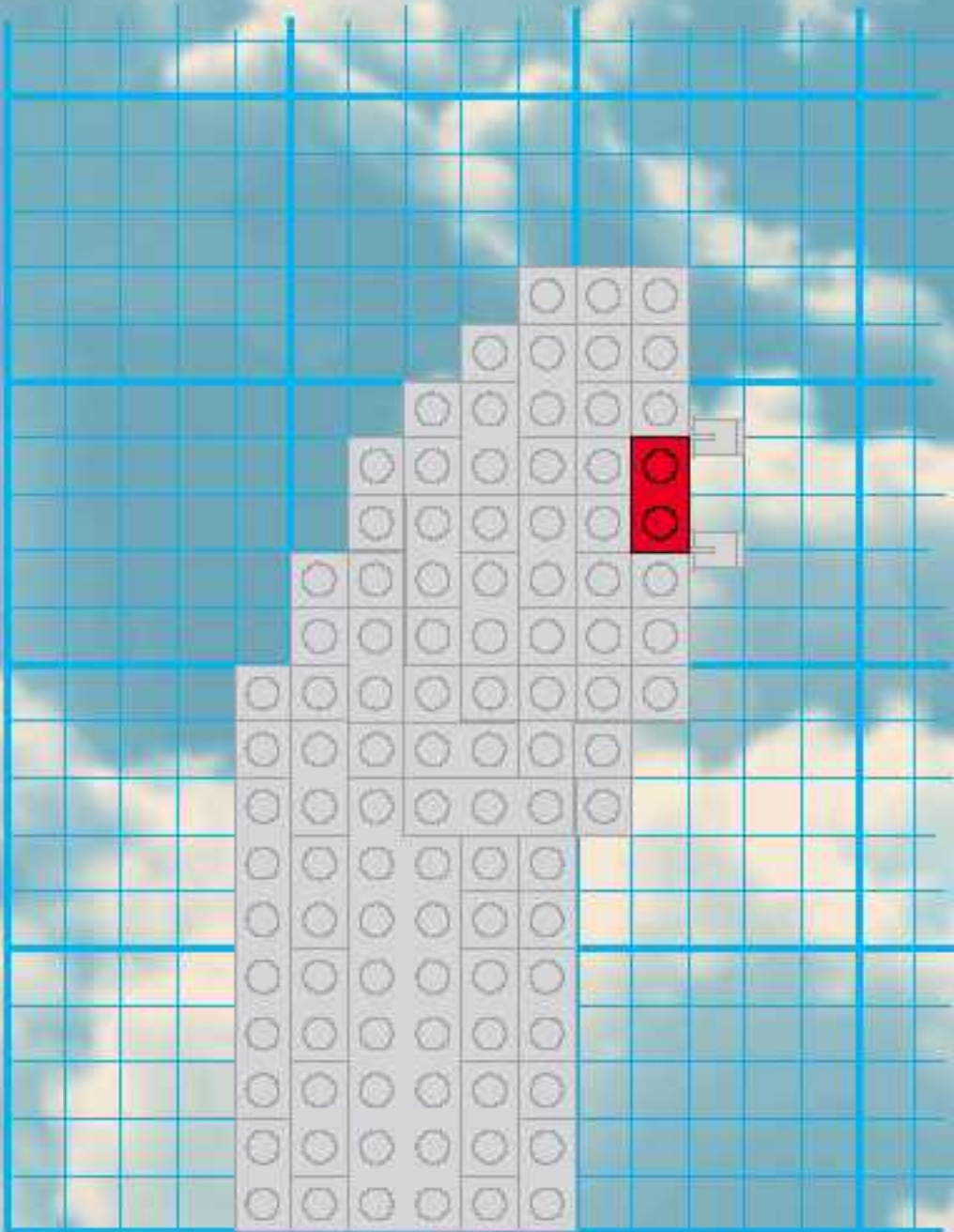

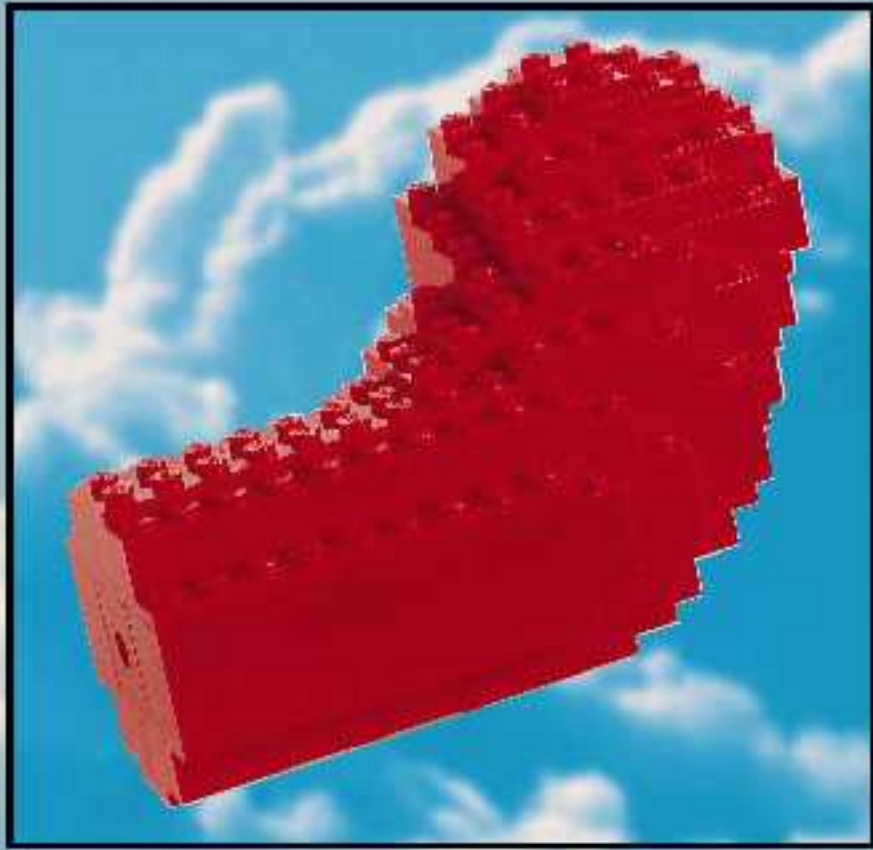

1

1x

1x

1x

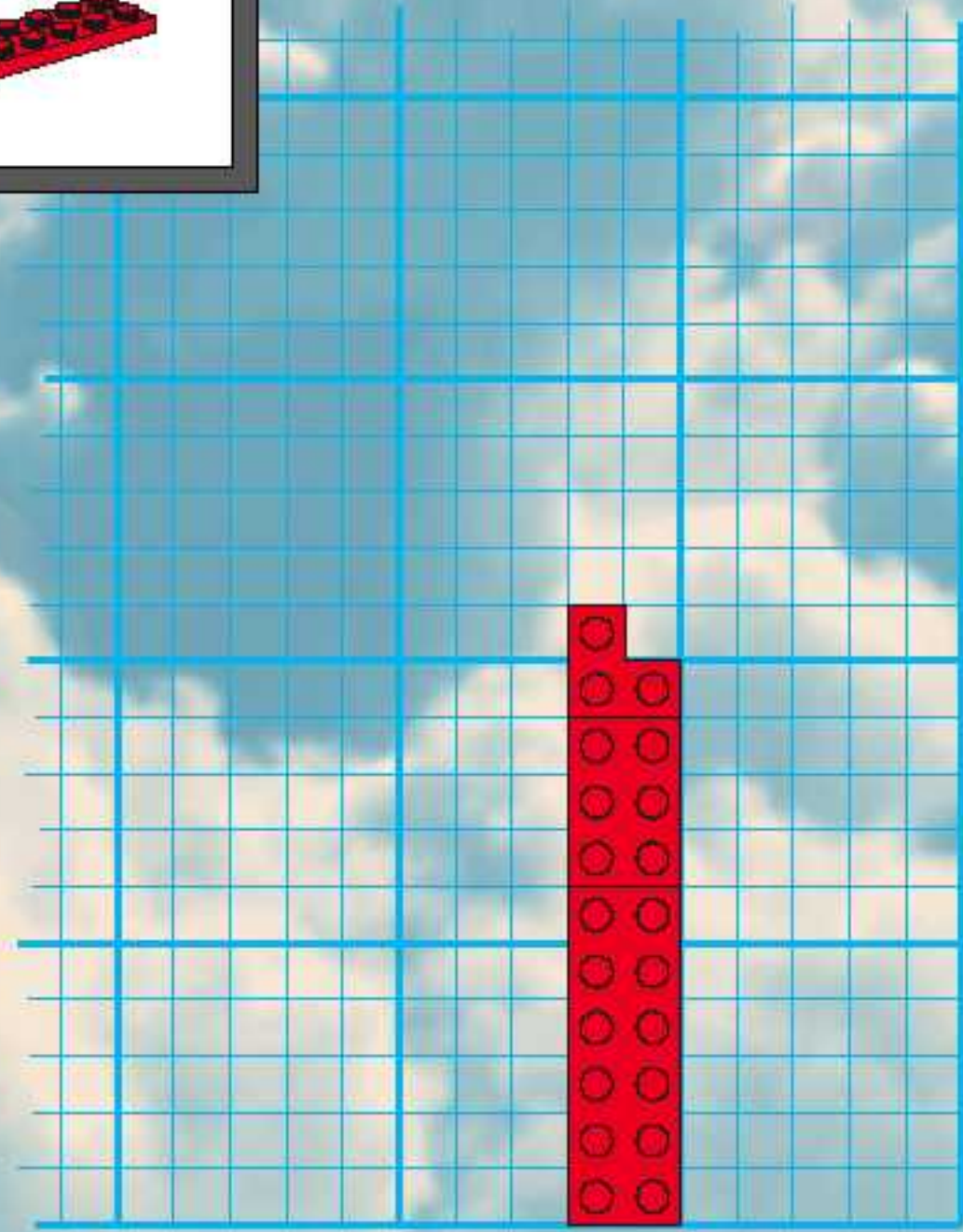

2

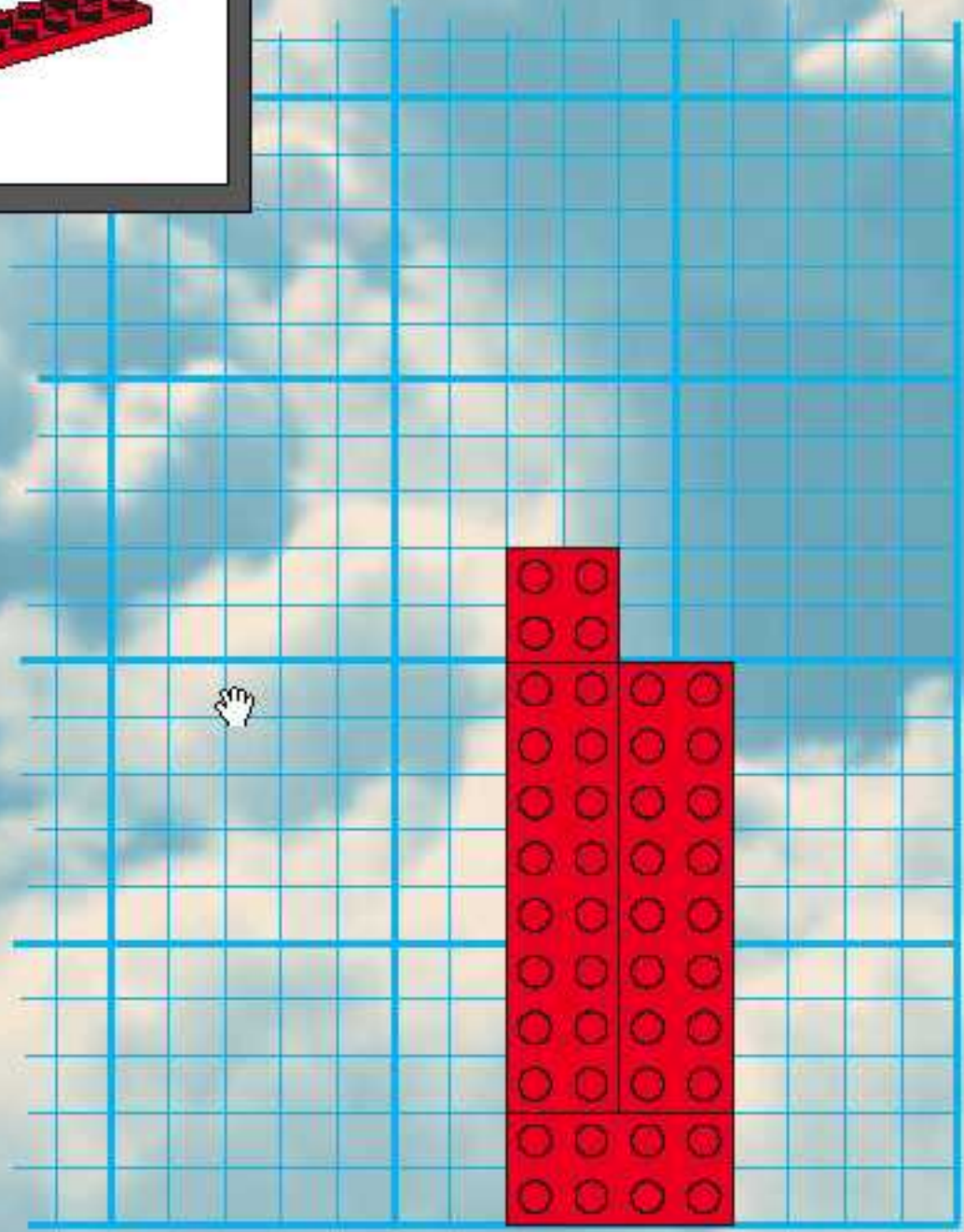

3

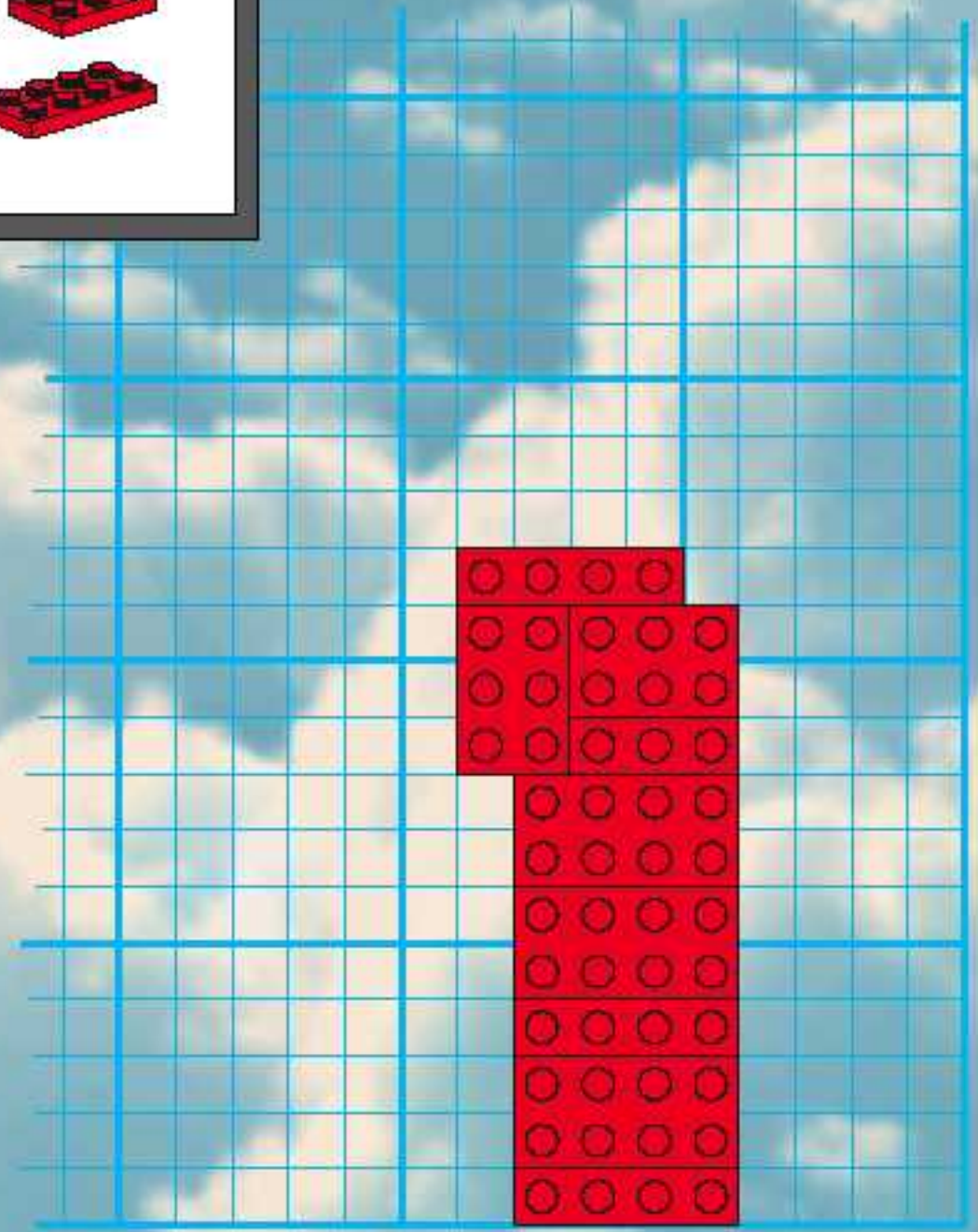

4

1x 

1x 

3x 

2x 

1x 

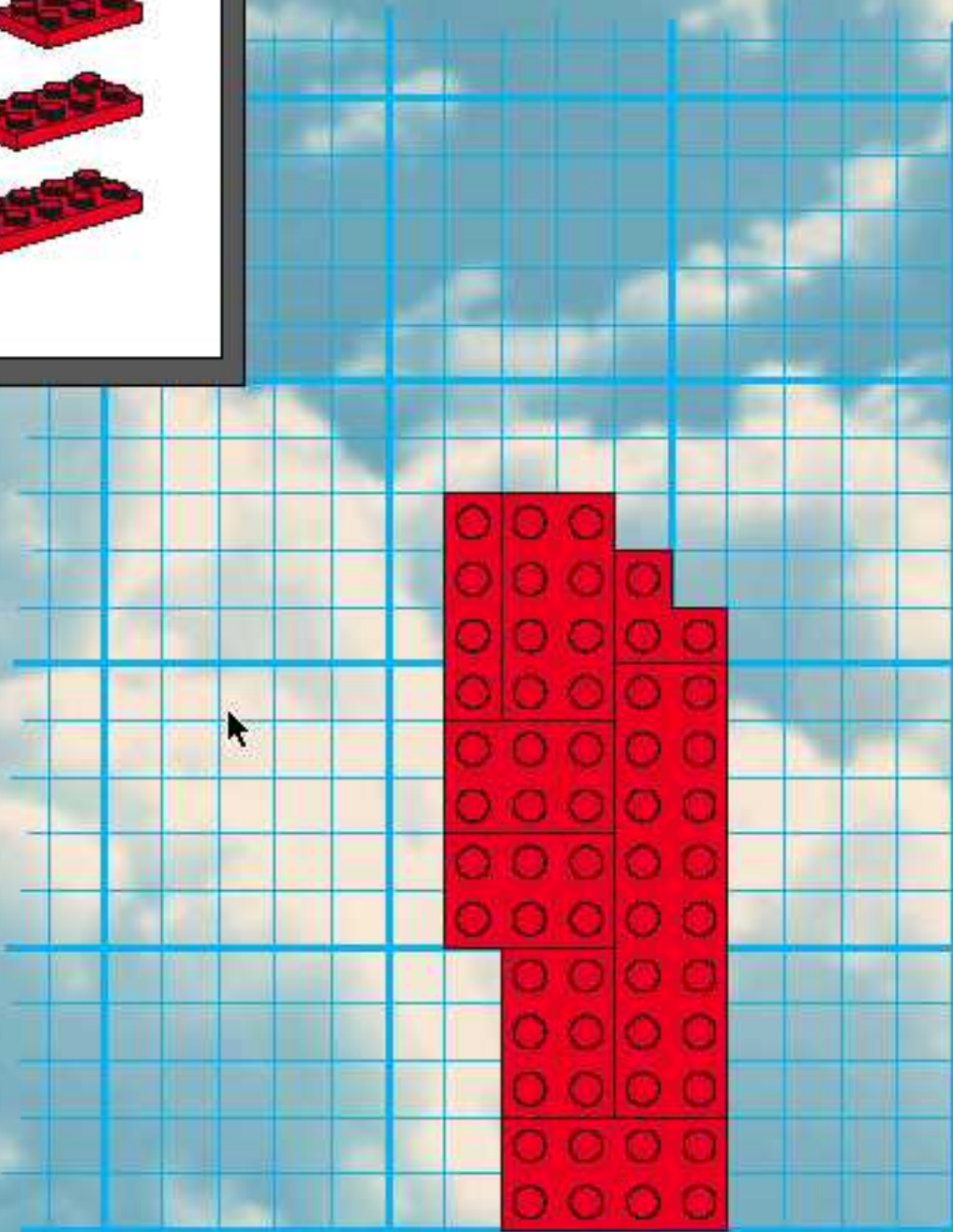

5

3x 

1x 

4x 

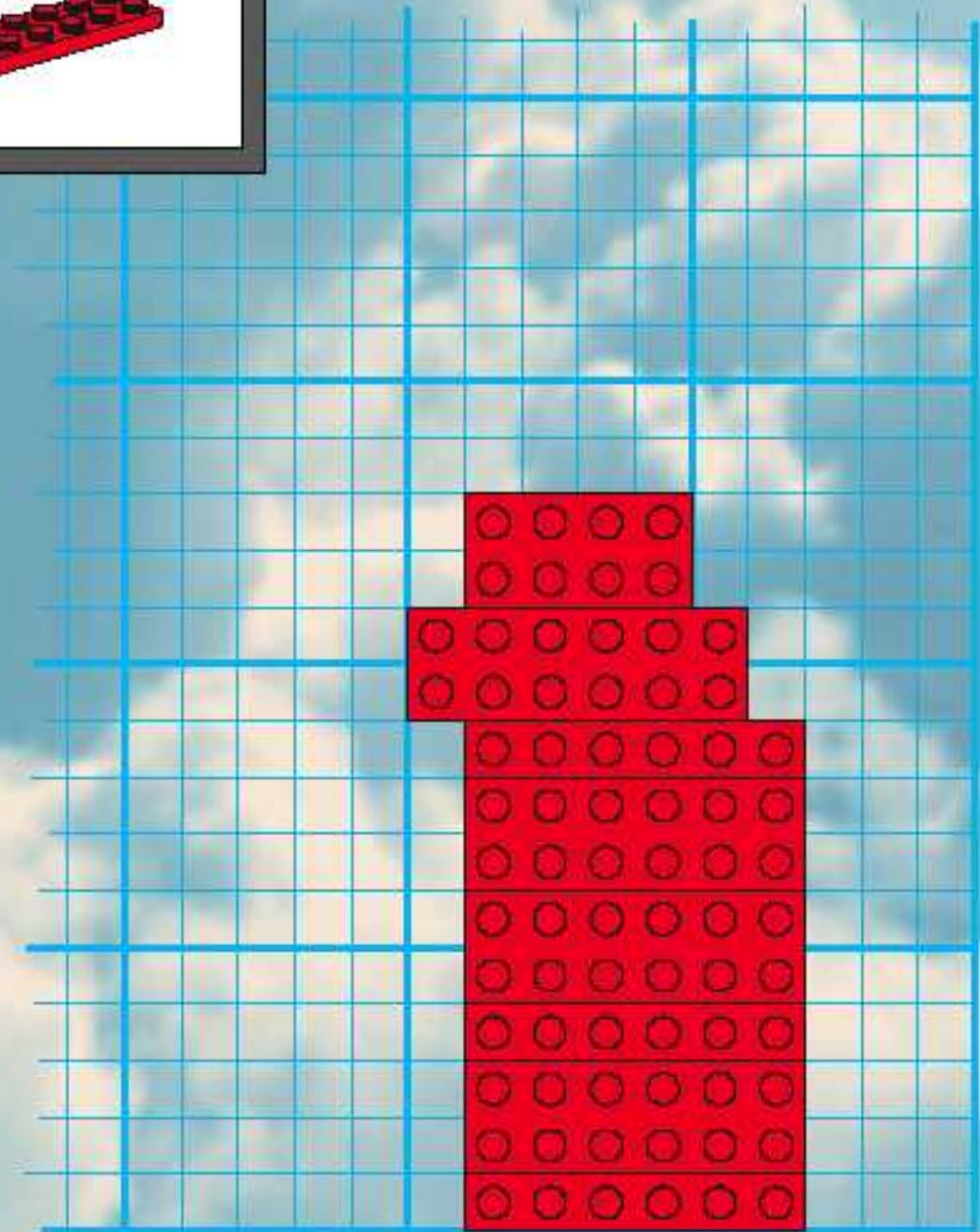

6

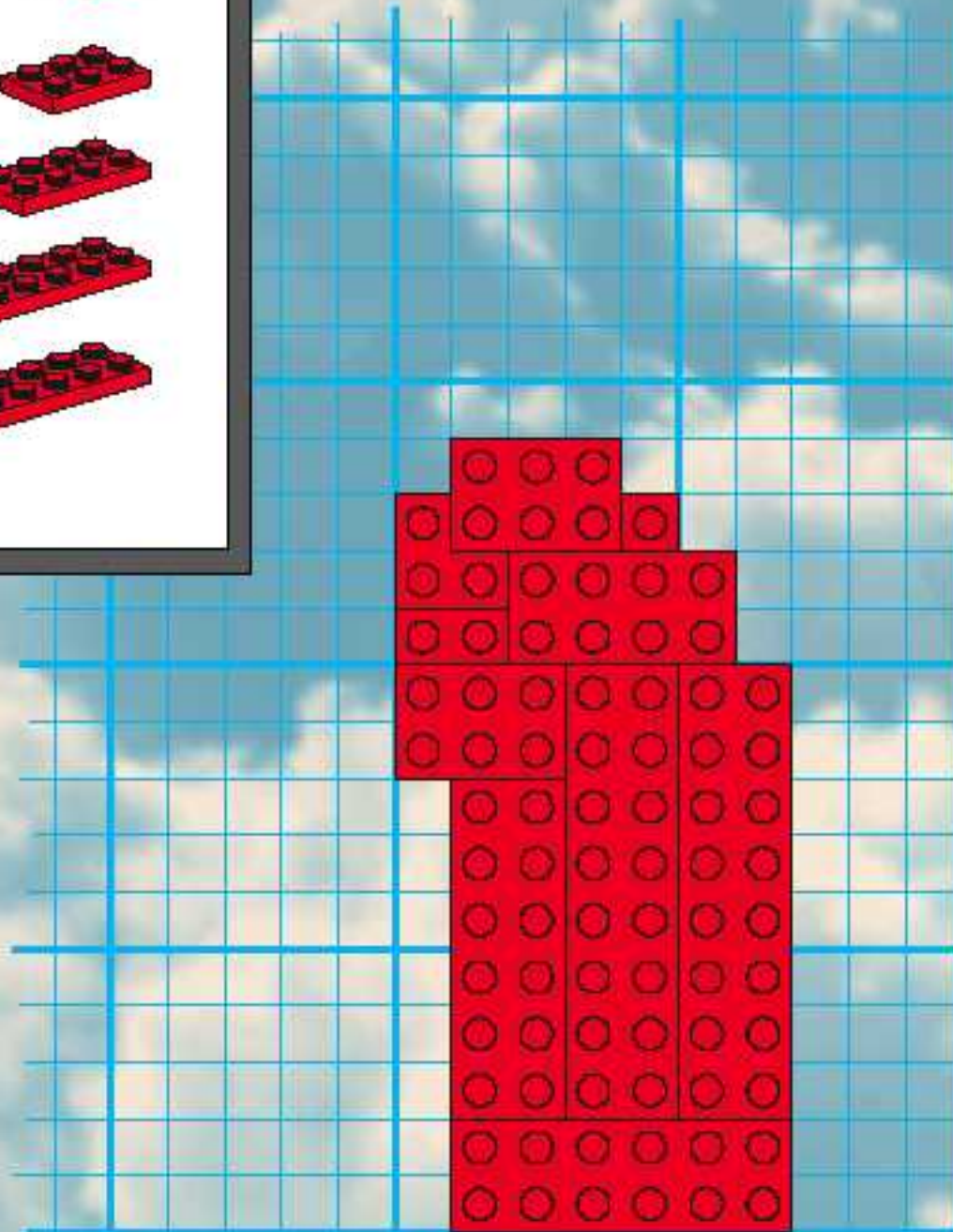

7

- 2x
- 4x
- 1x
- 1x
- 1x
- 1x
- 5x
- 2x
- 5x
- 2x
- 2x
- 2x
- 1x

1

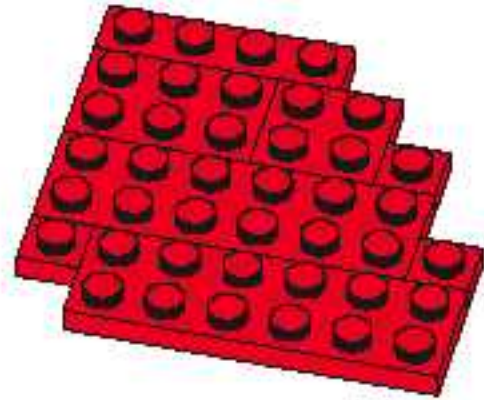

2

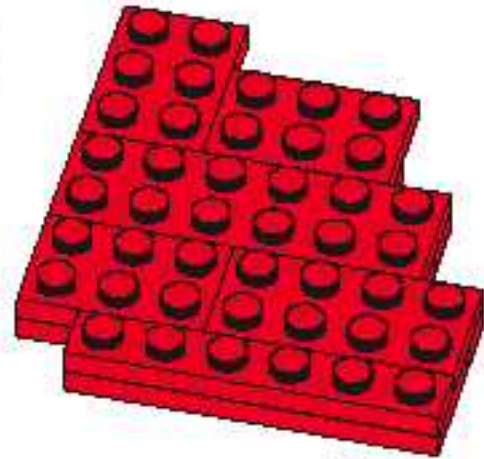

3

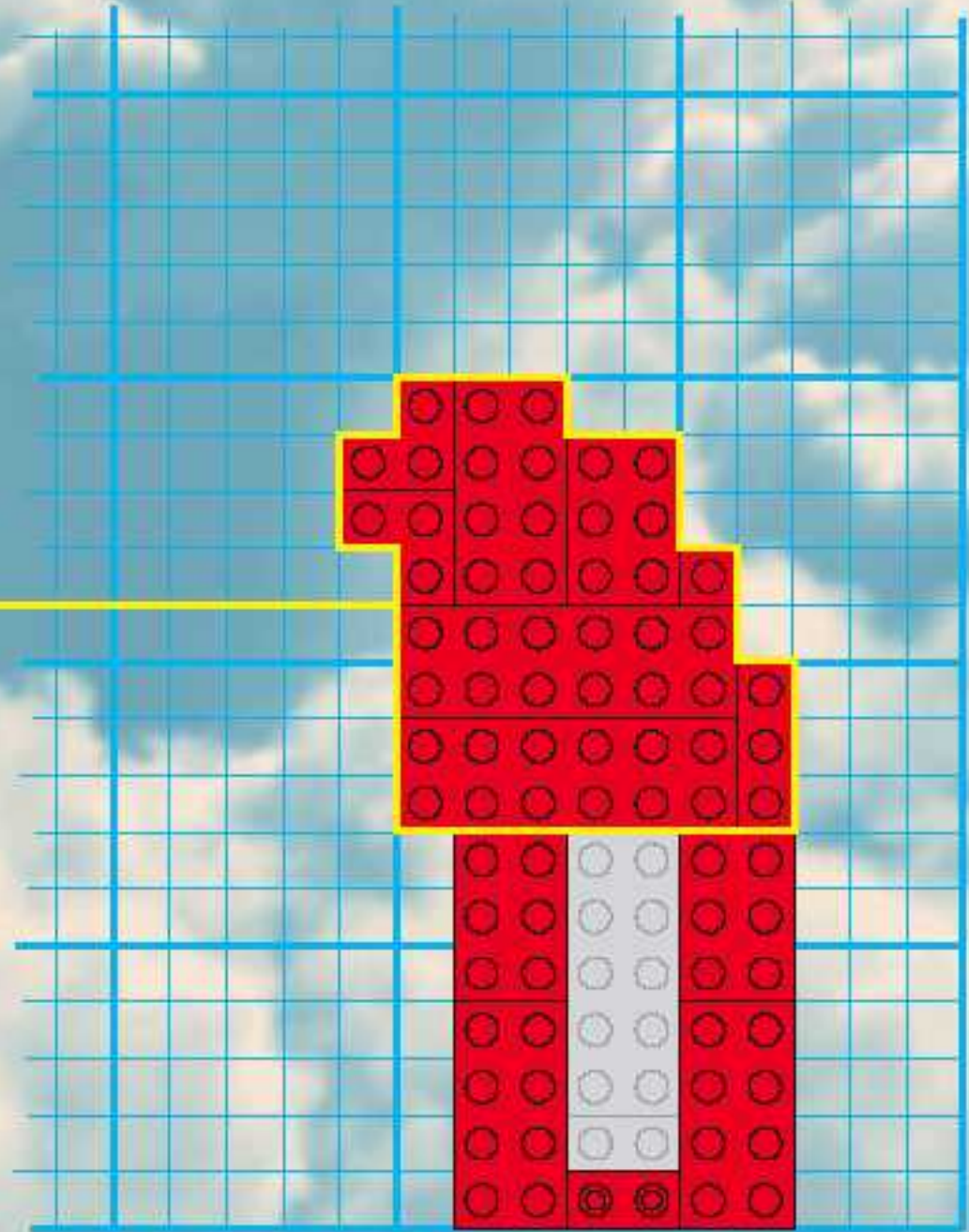
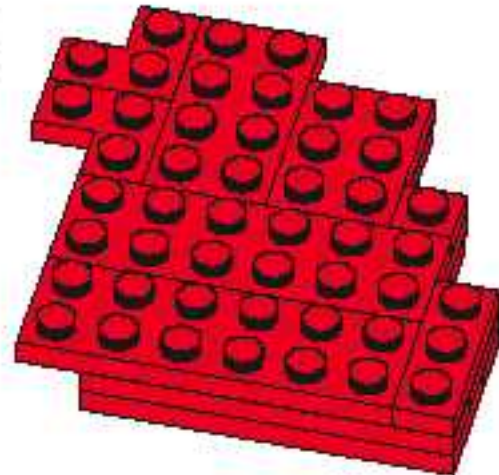

8

- 3x
- 3x
- 2x
- 2x
- 3x
- 3x
- 3x
- 3x
- 3x
- 1x
- 1x
- 3x

1

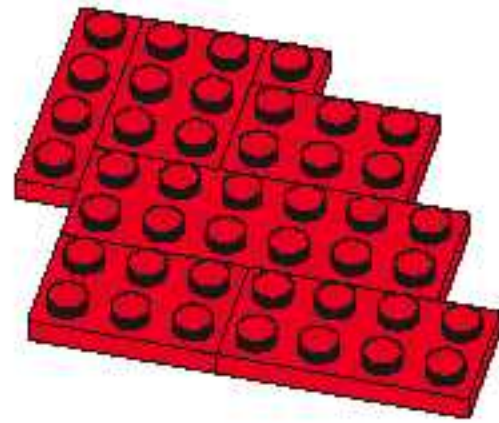

2

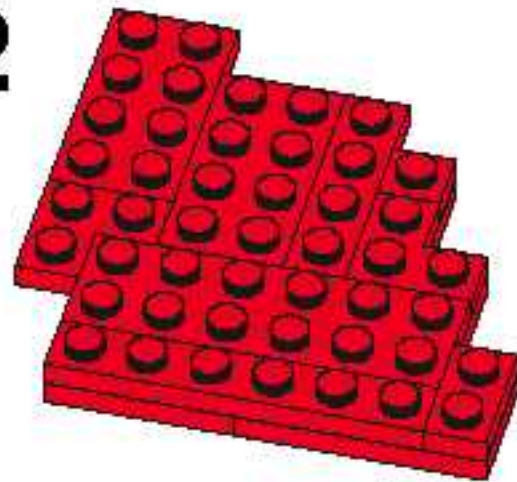

3

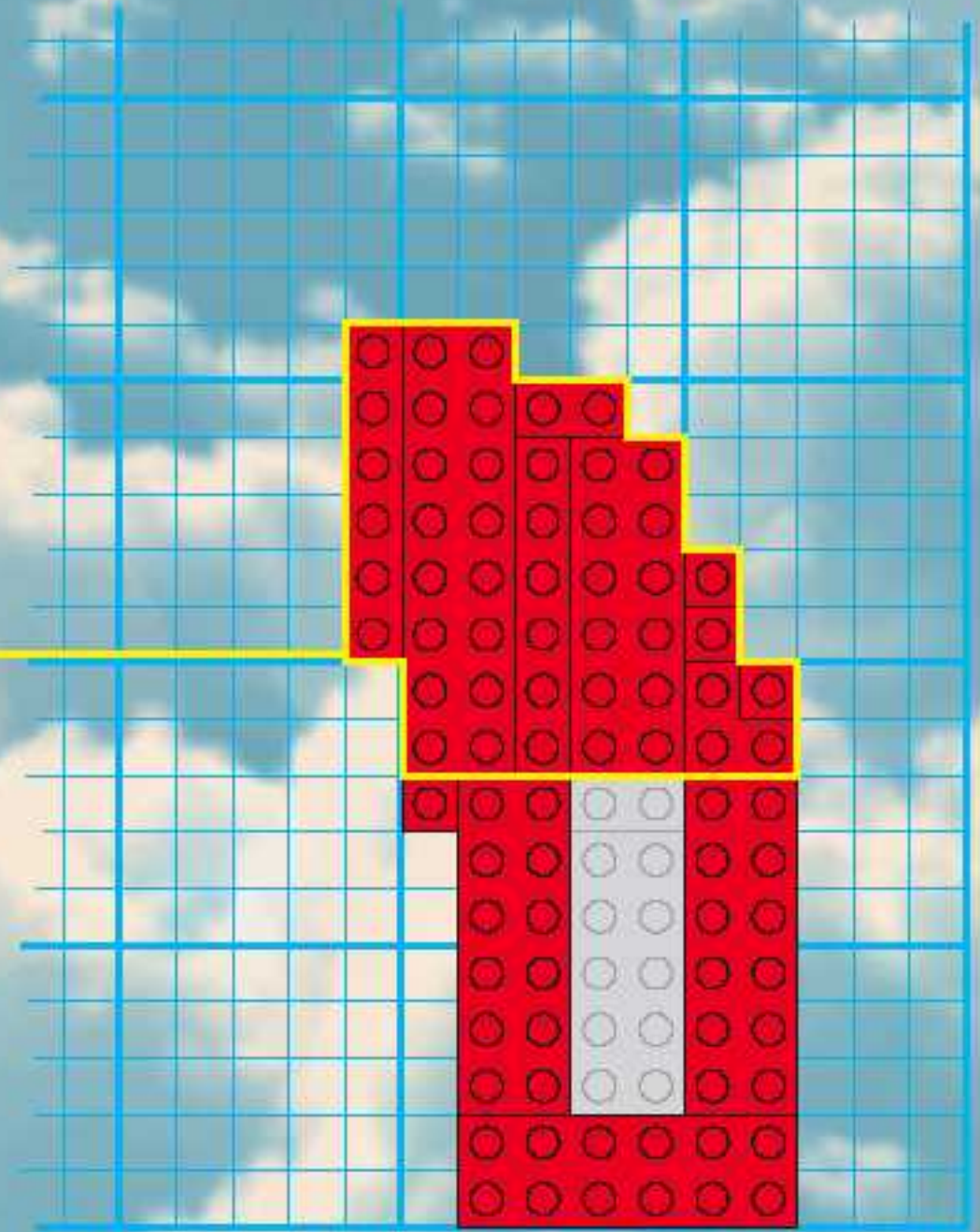
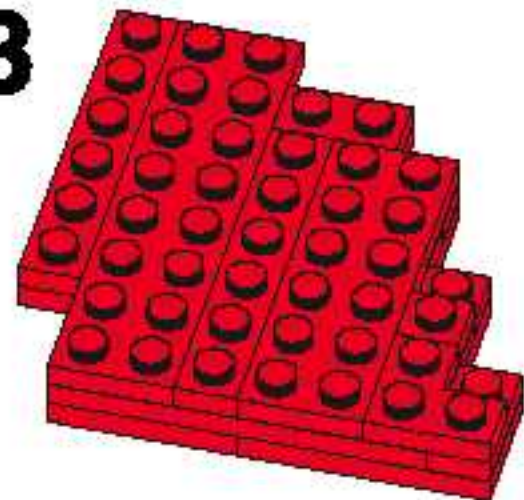

9



1

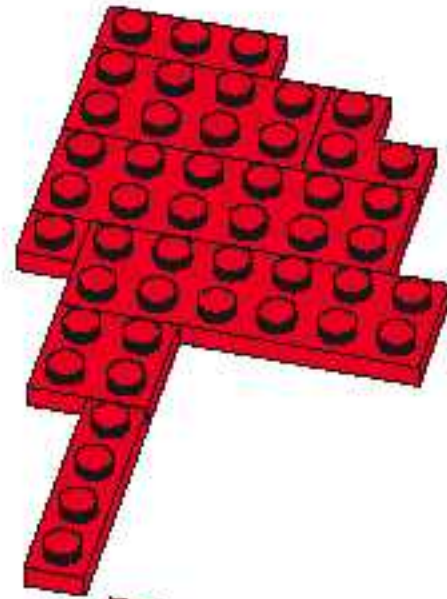

2

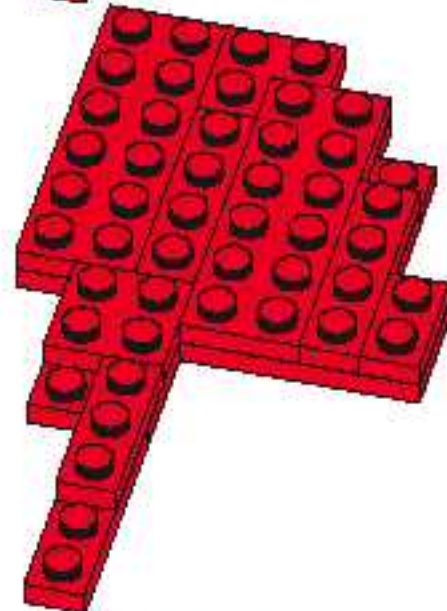



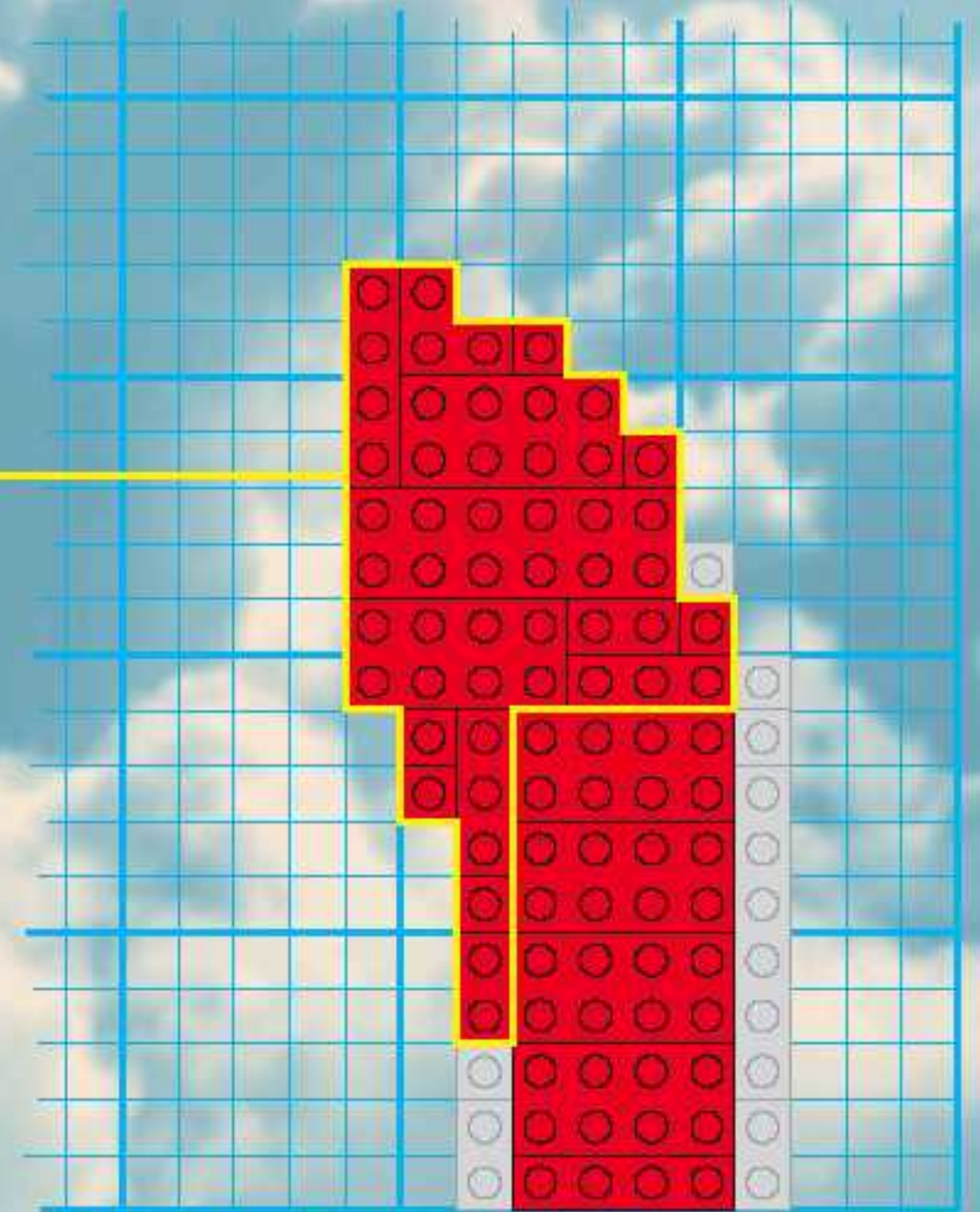
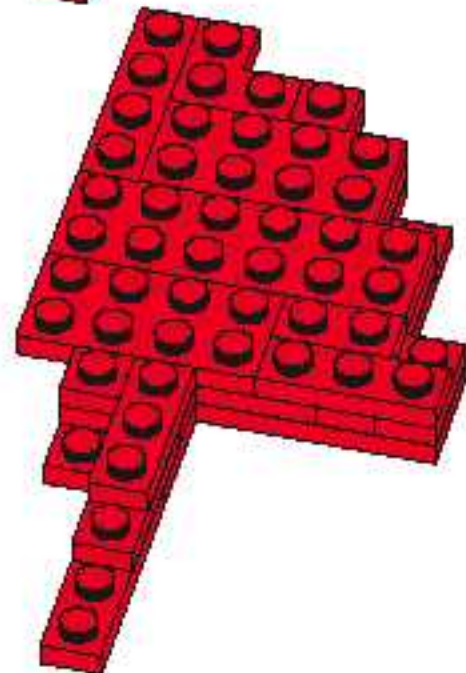



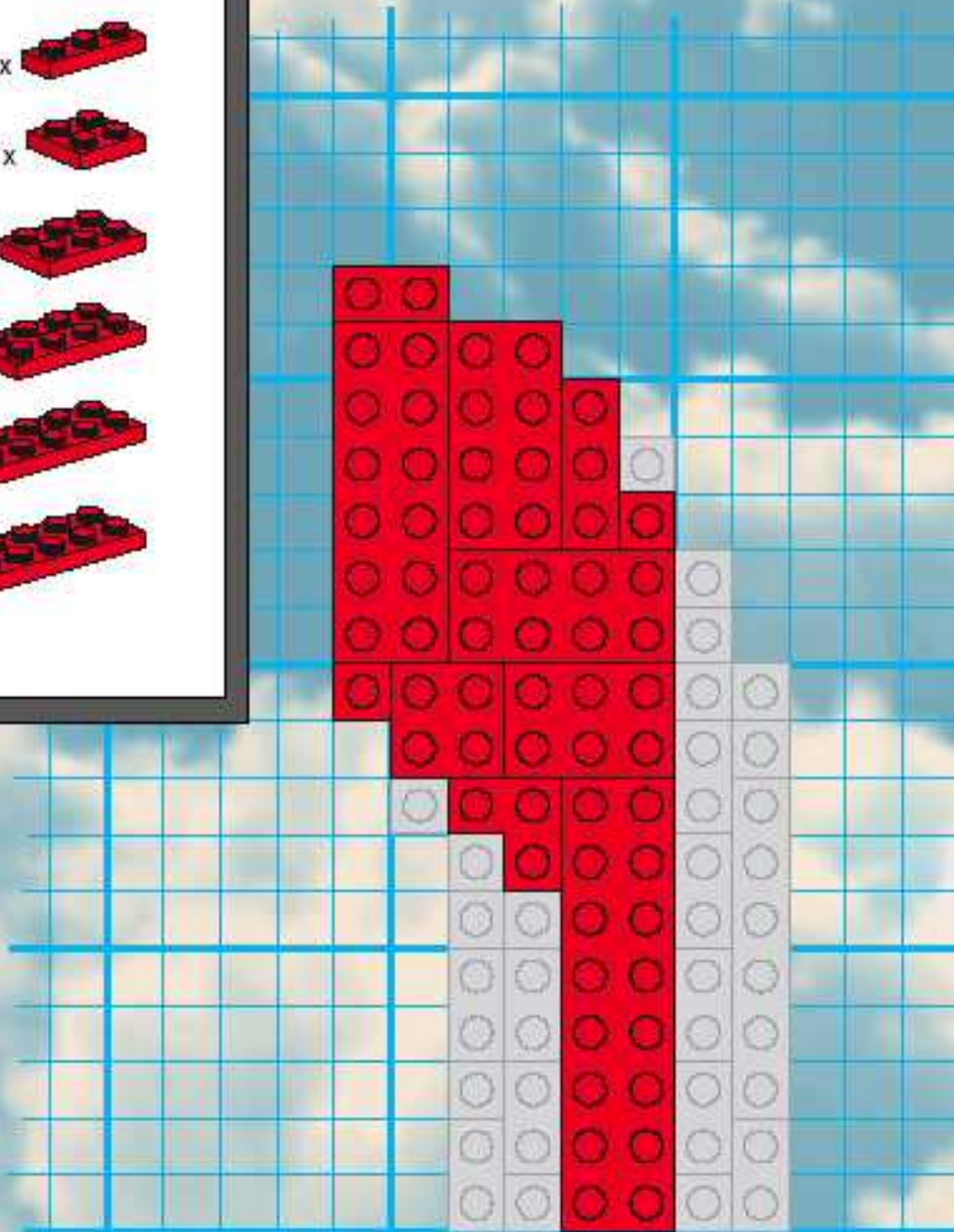





3



10



11

- 2x 
- 5x 
- 4x 
- 3x 
- 1x 
- 1x 
- 1x 
- 1x 
- 1x 
- 1x 
- 1x 
- 1x 

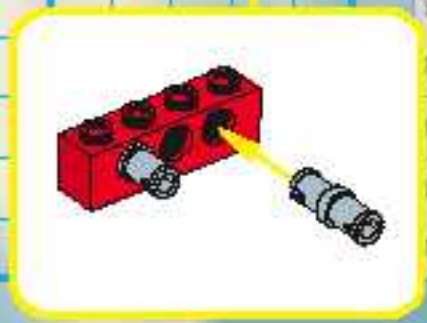
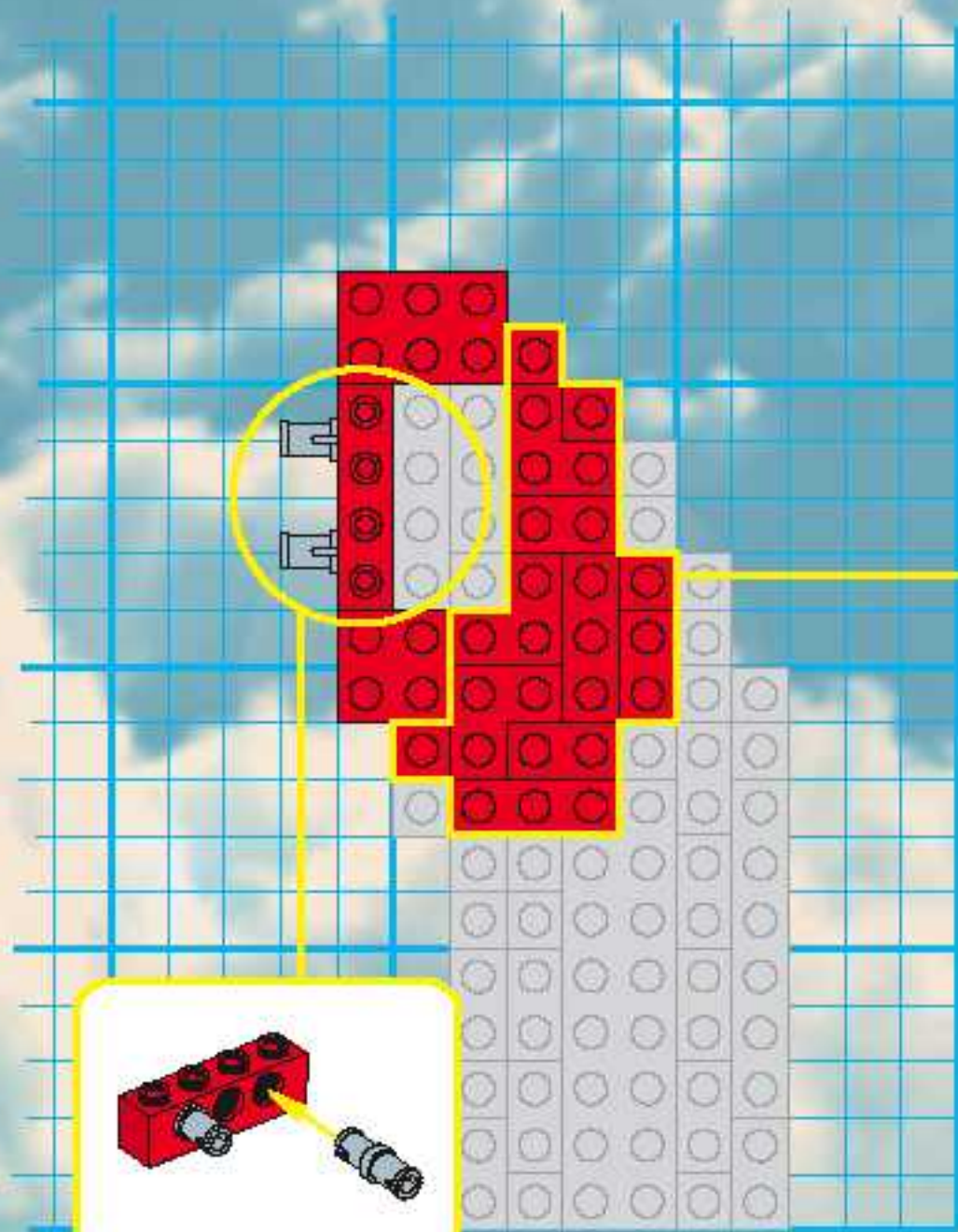

1

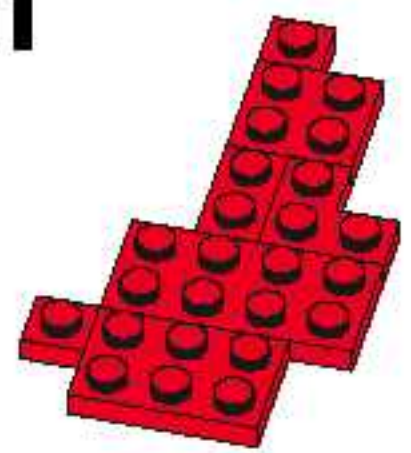

2

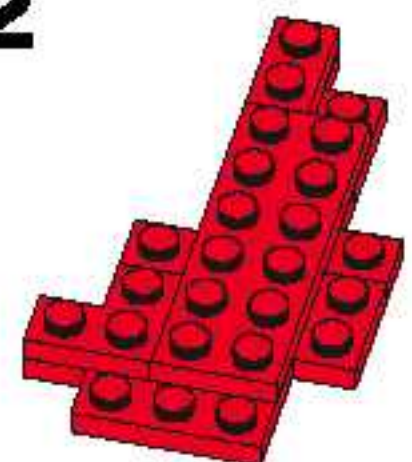

3

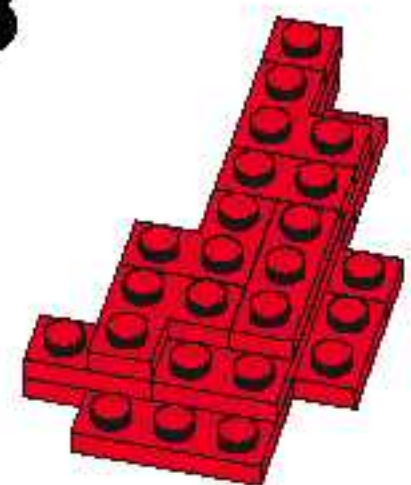

12

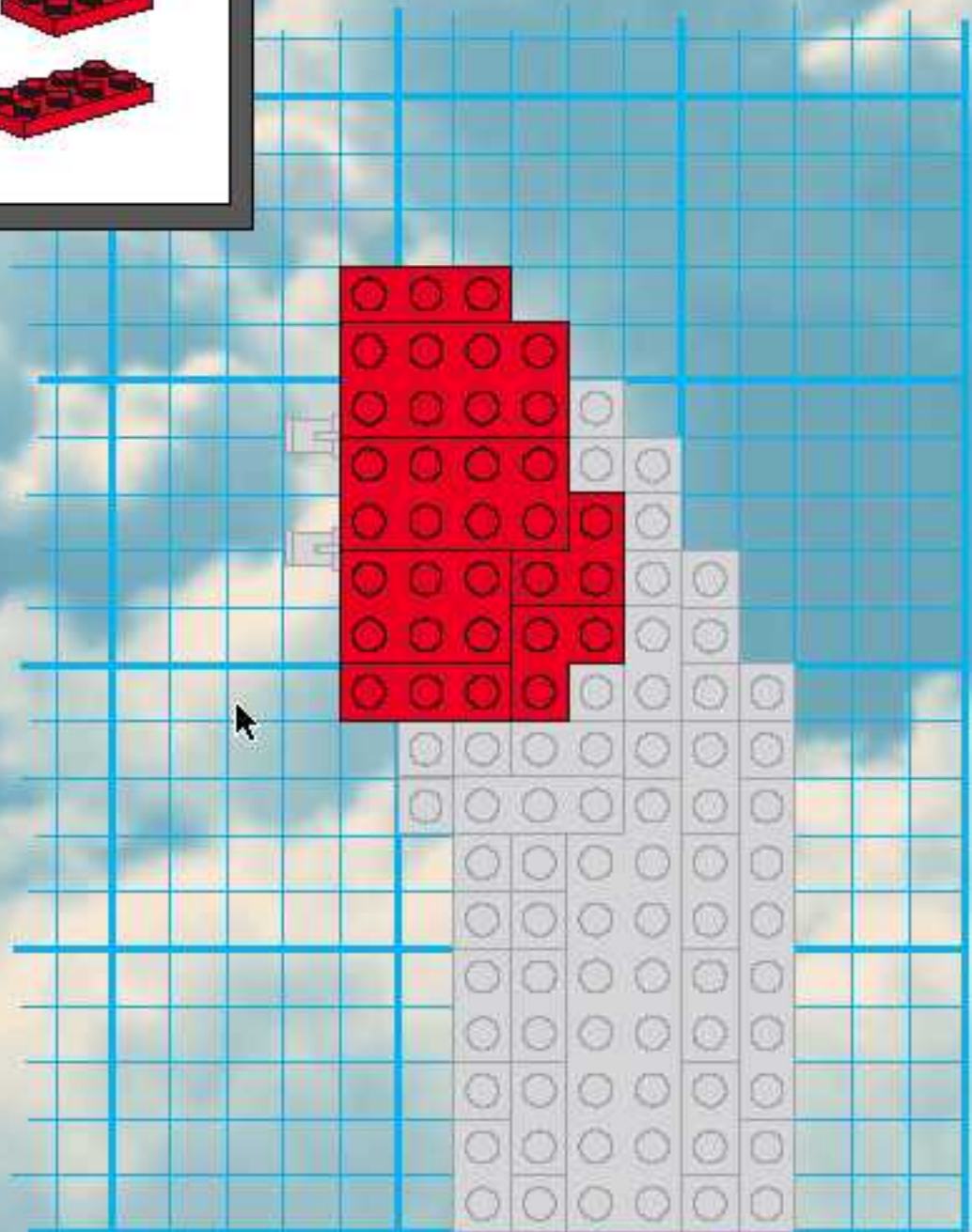

13

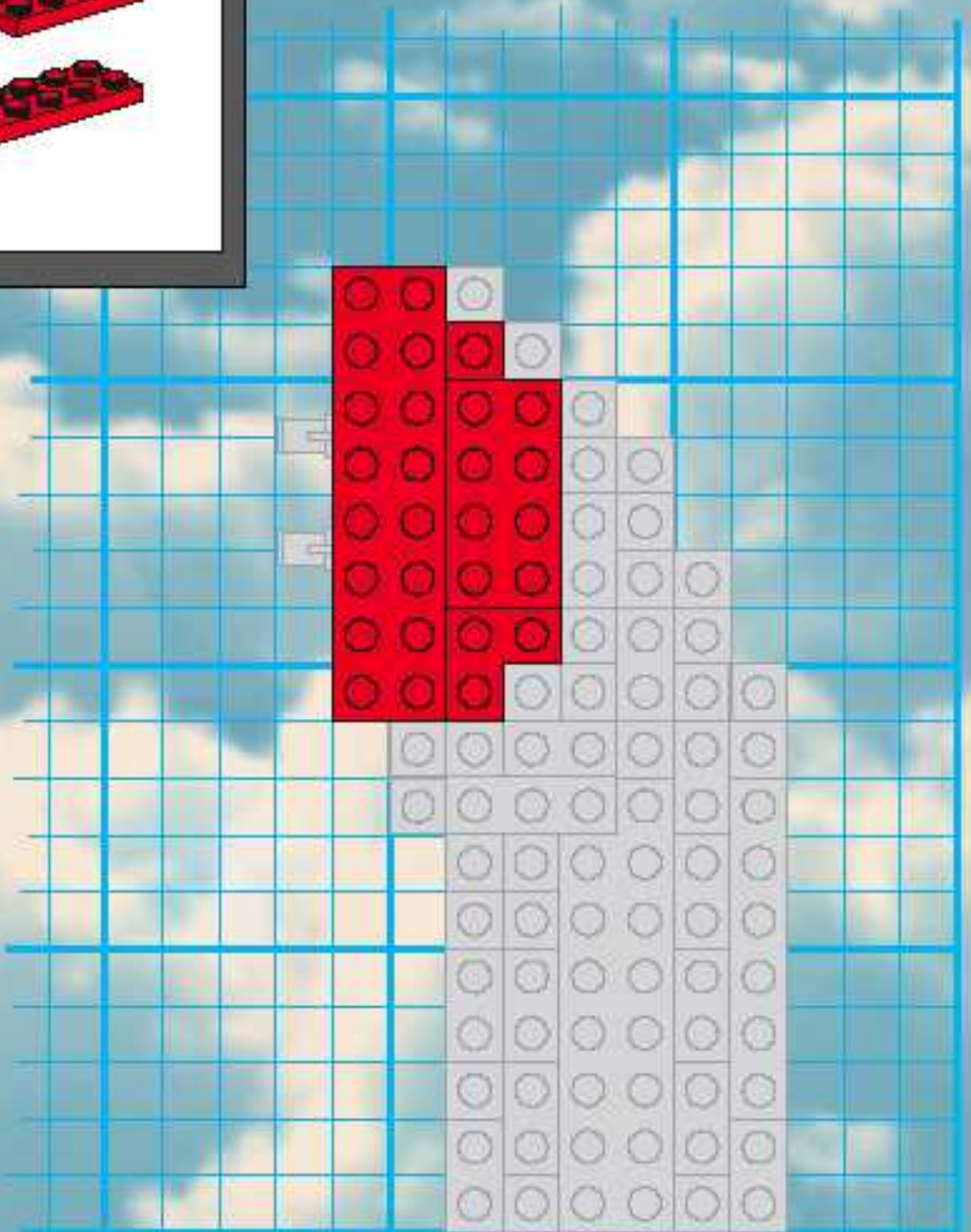

14

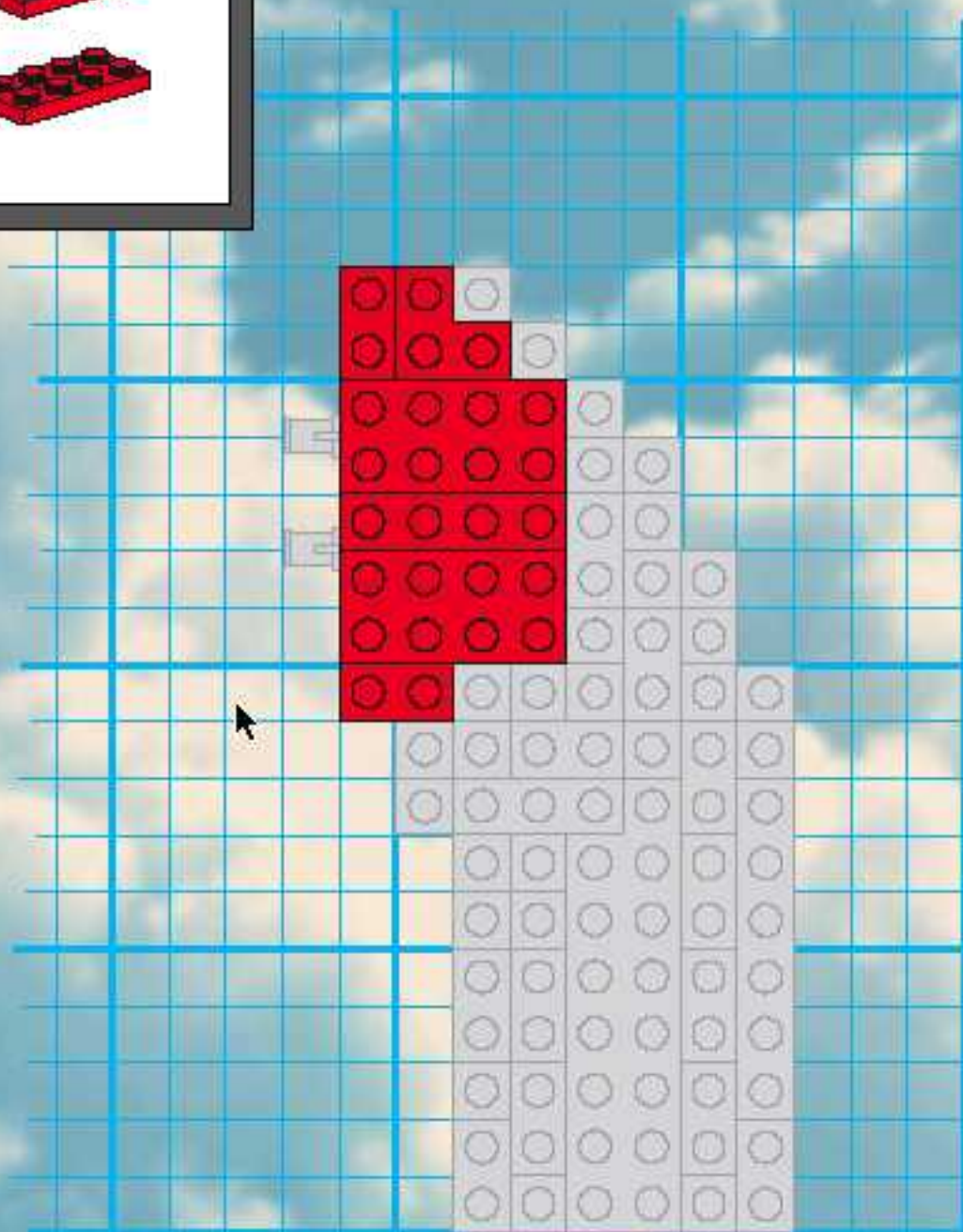

15

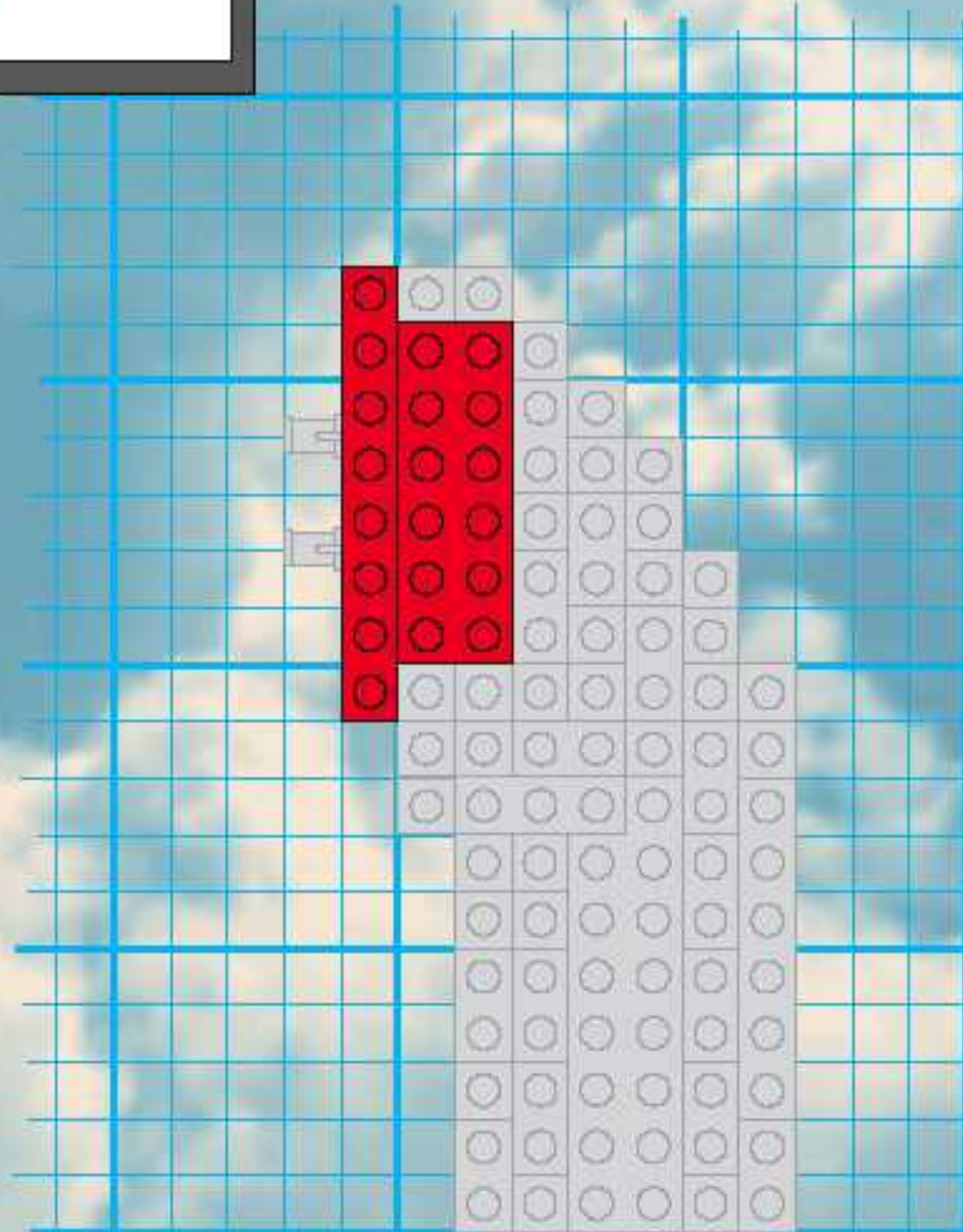

16

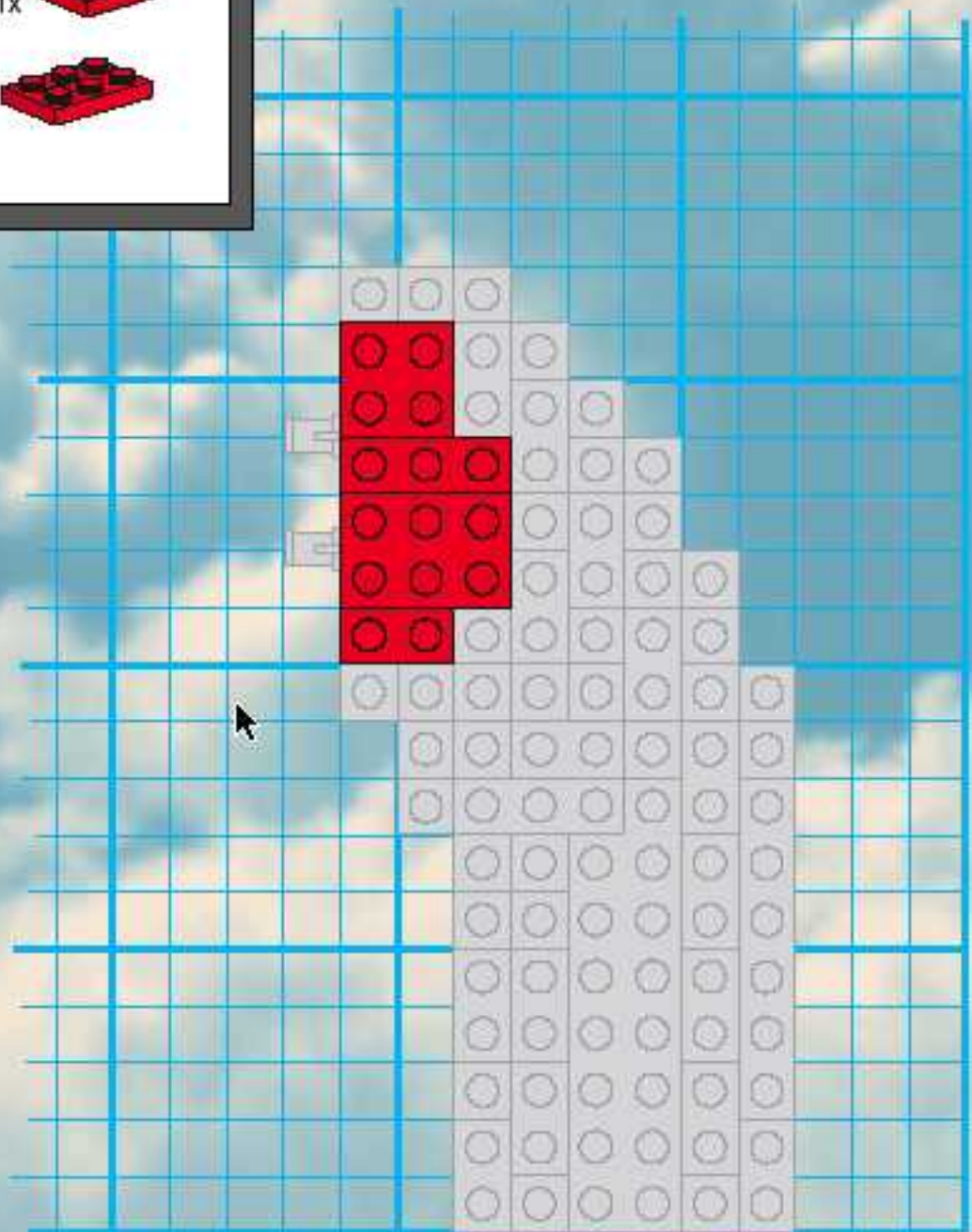

17

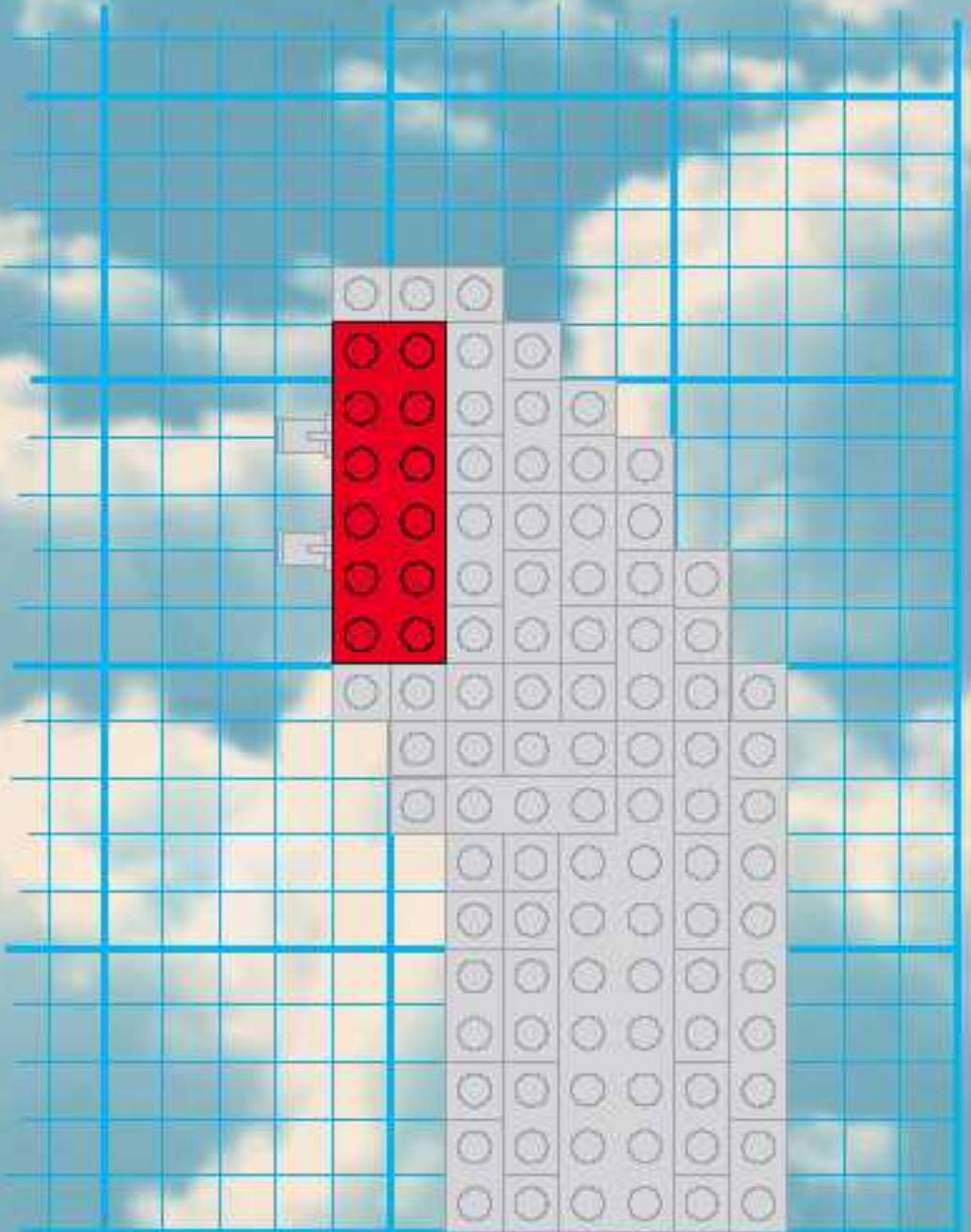

18

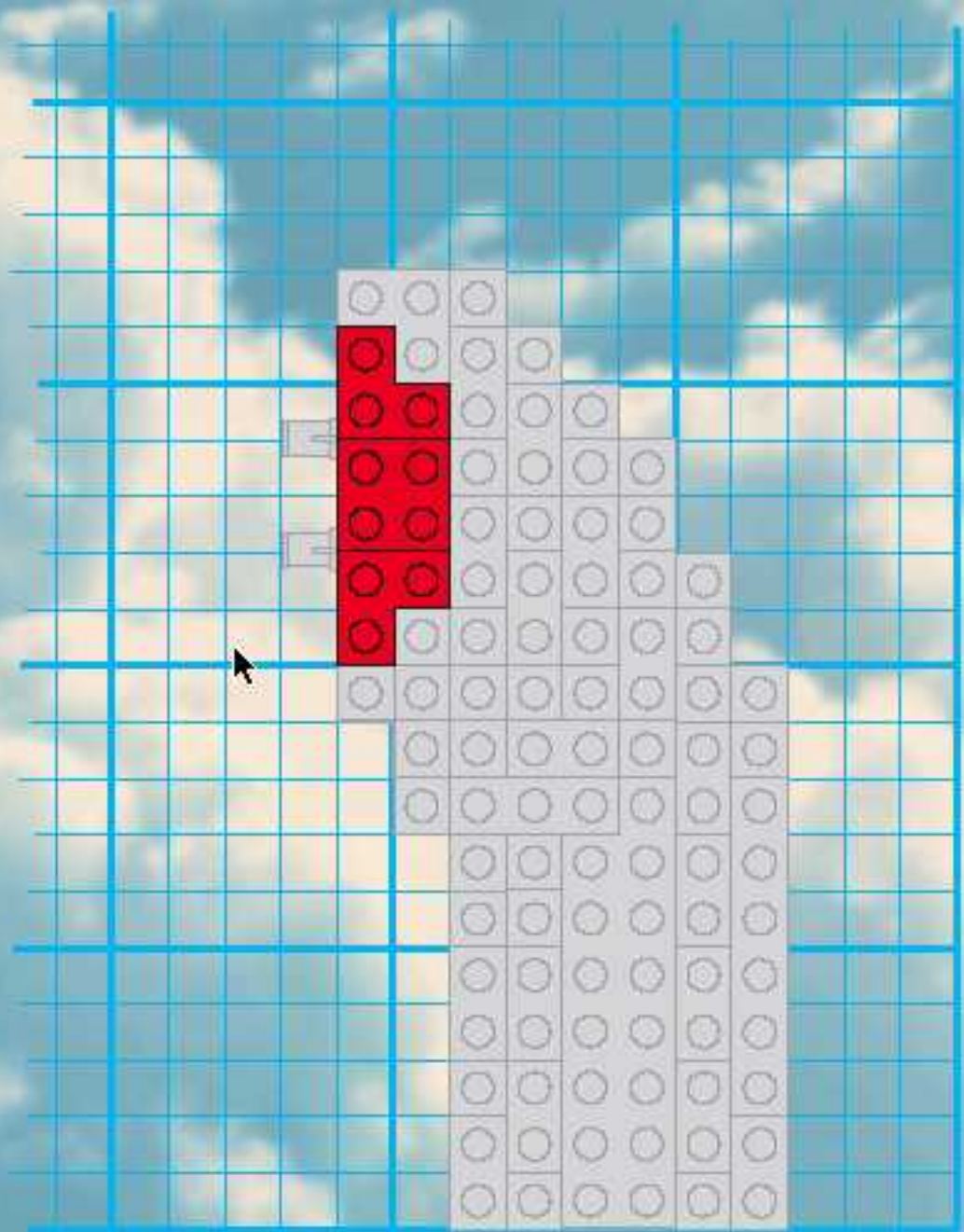

19

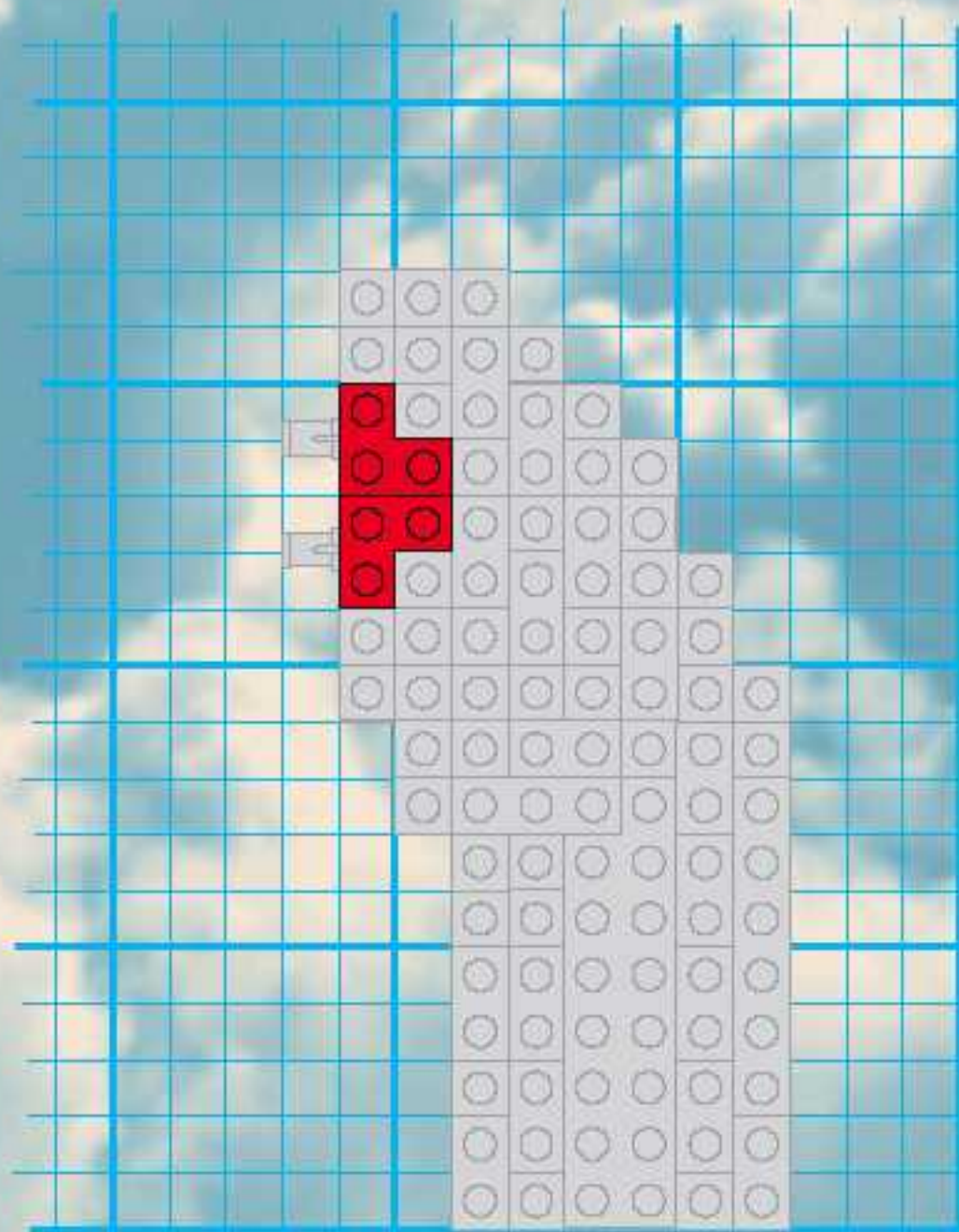

20

1x

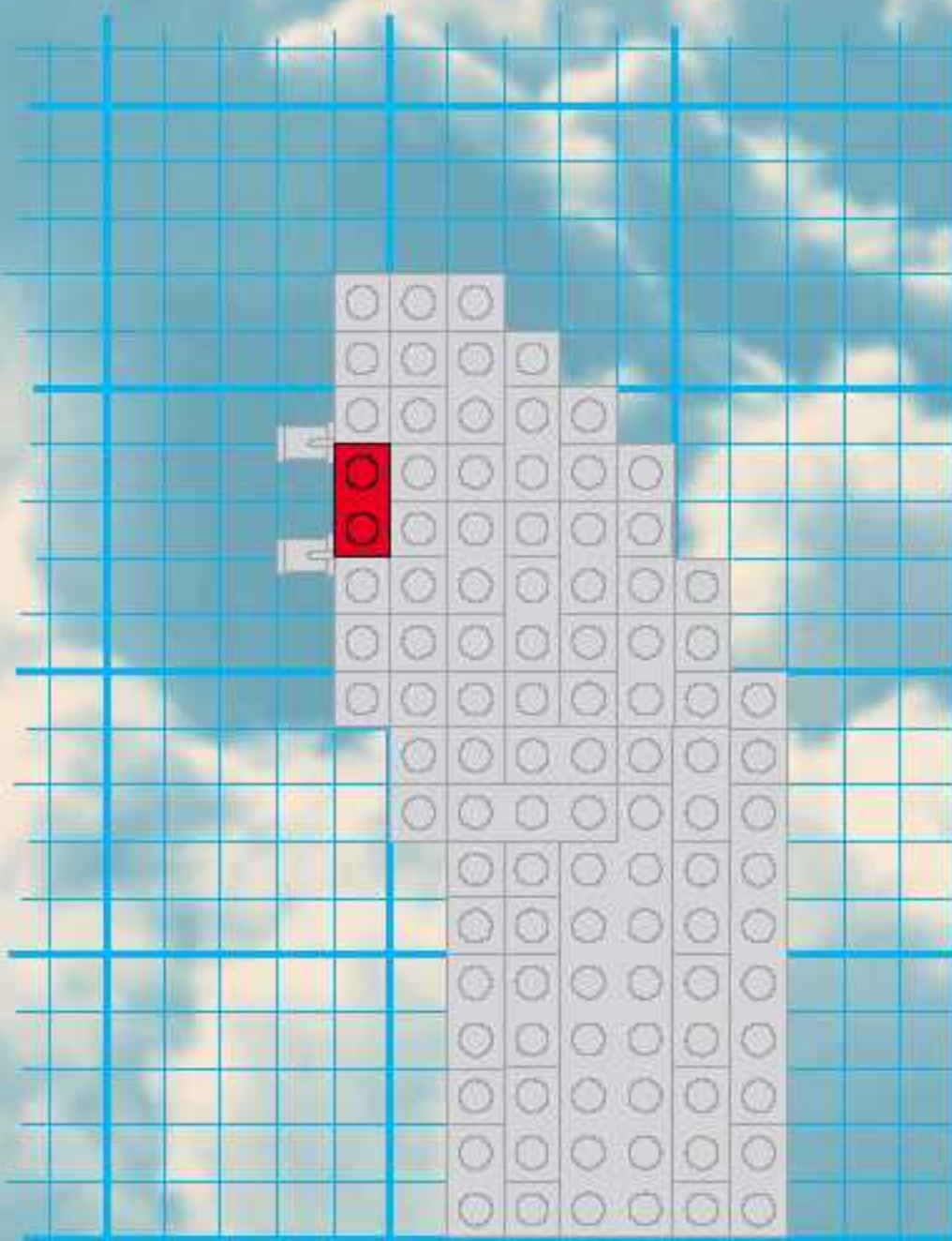

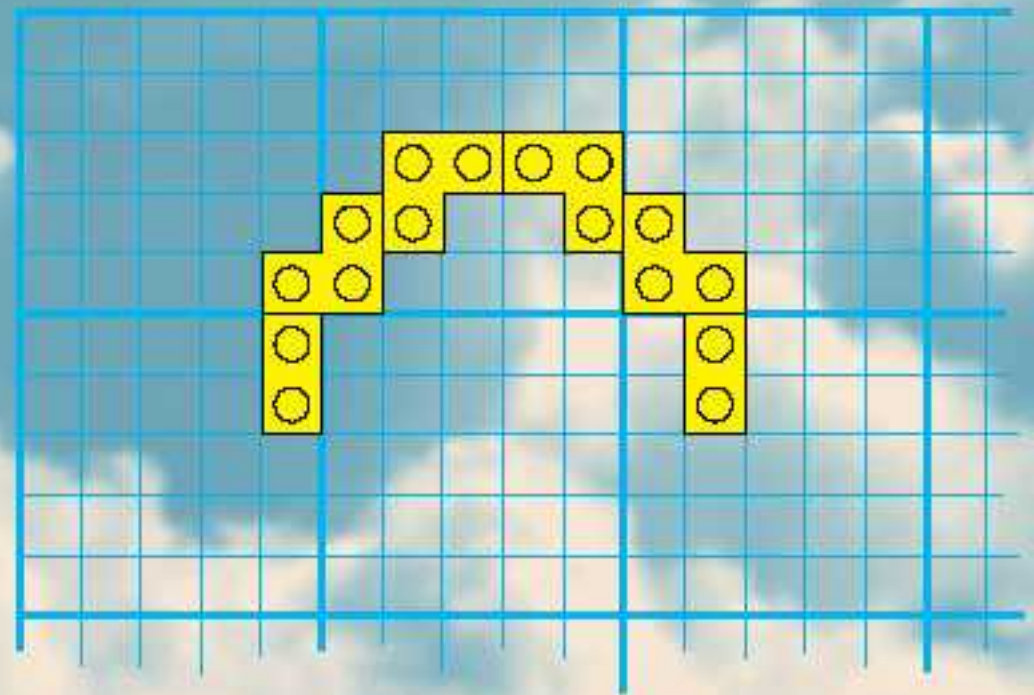
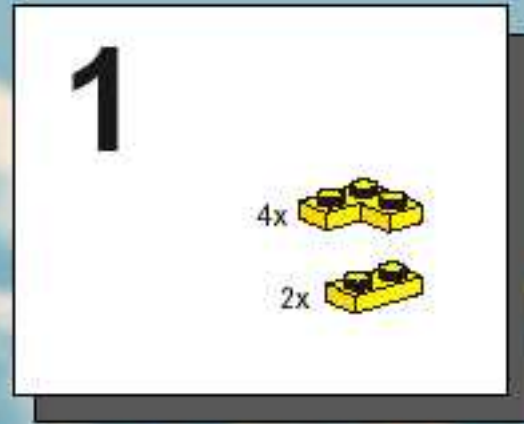
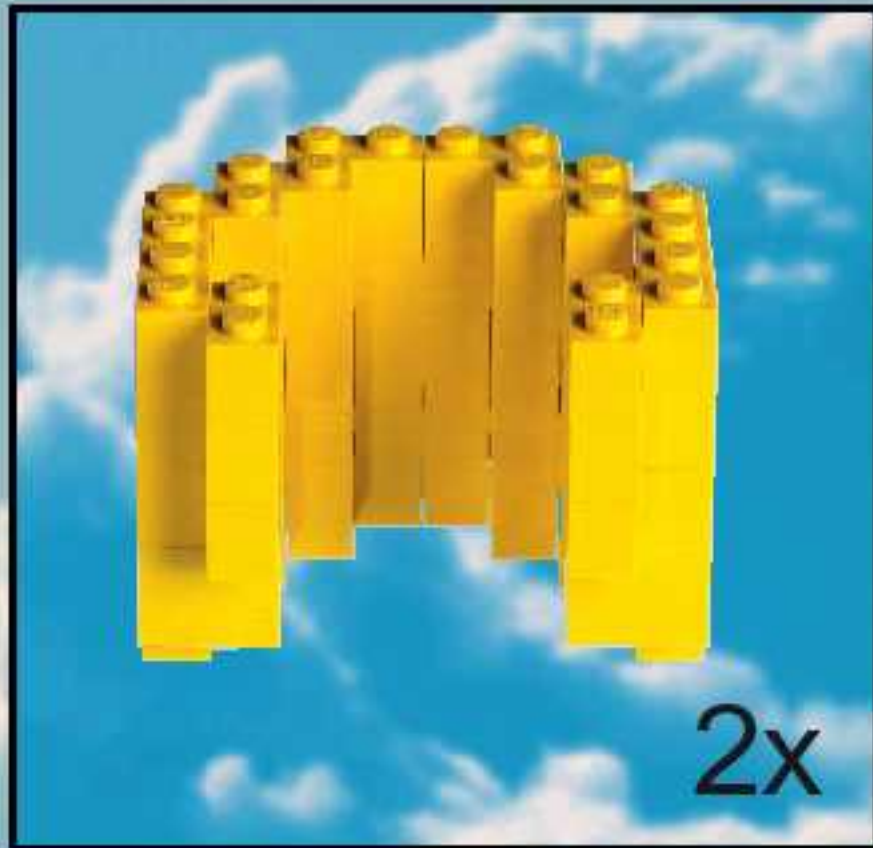

2

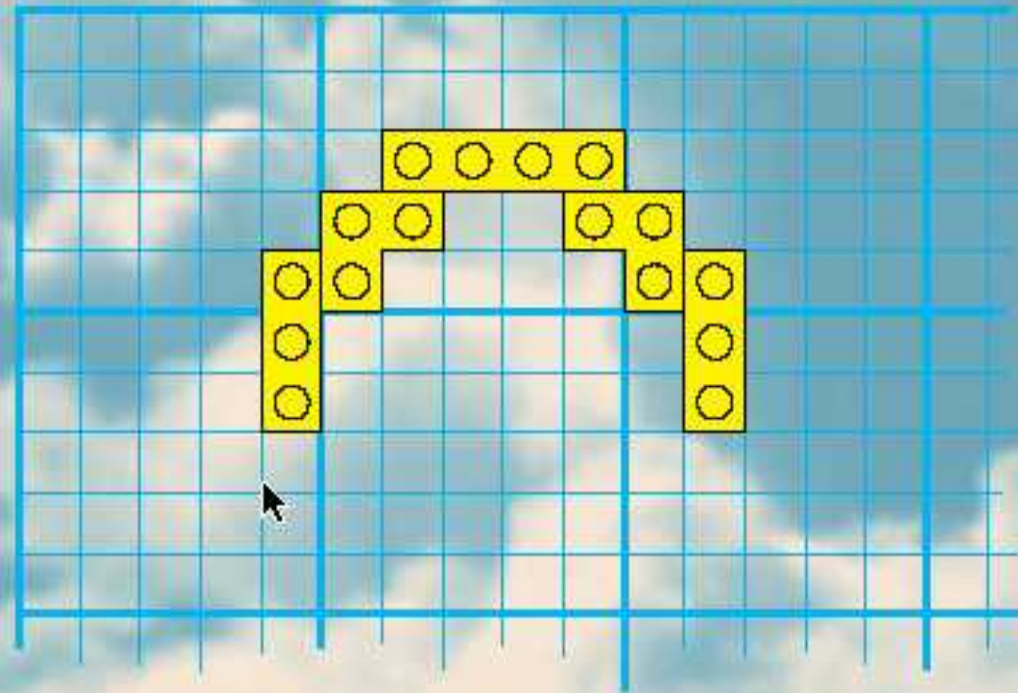
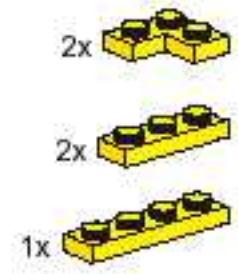

3

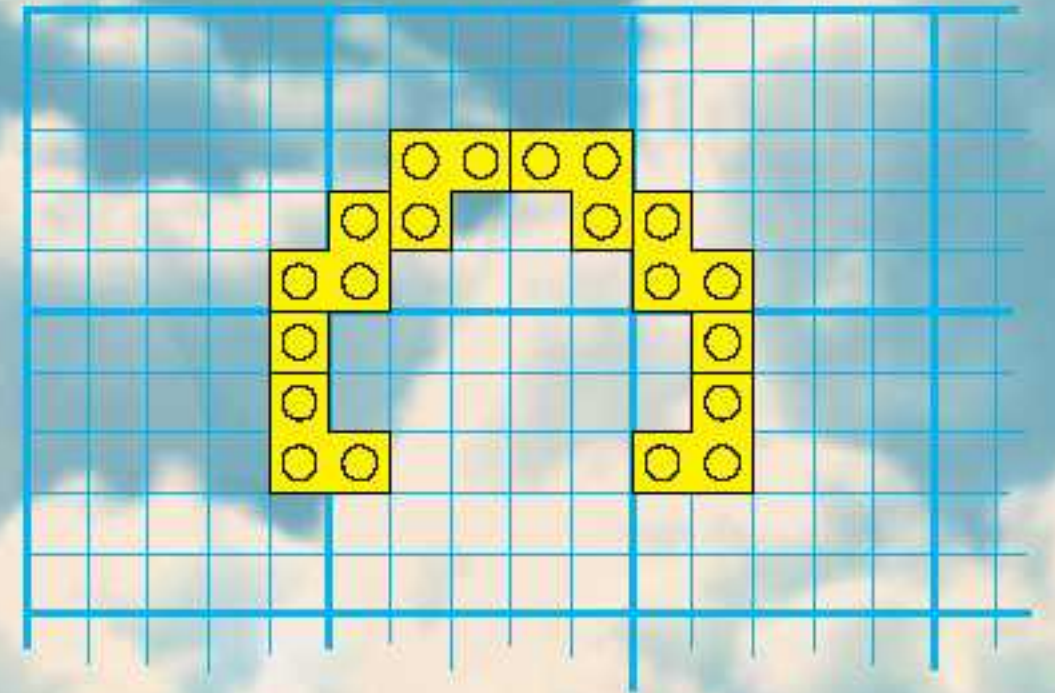
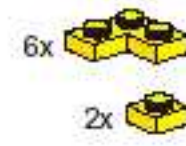

4

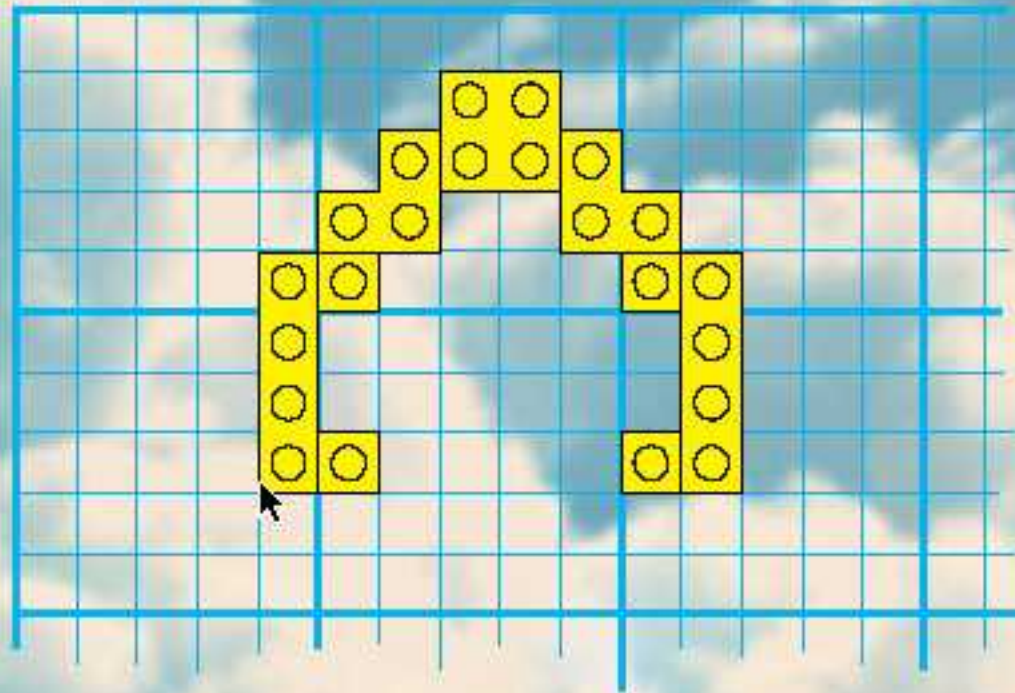
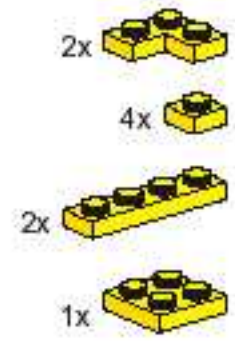

5

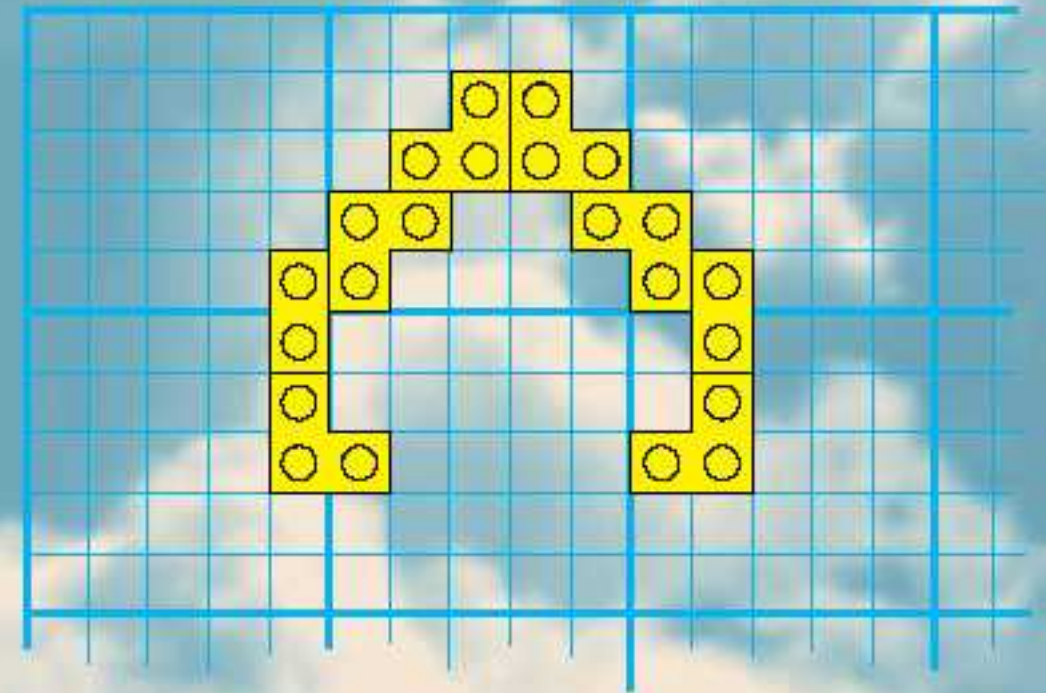
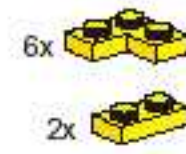

6

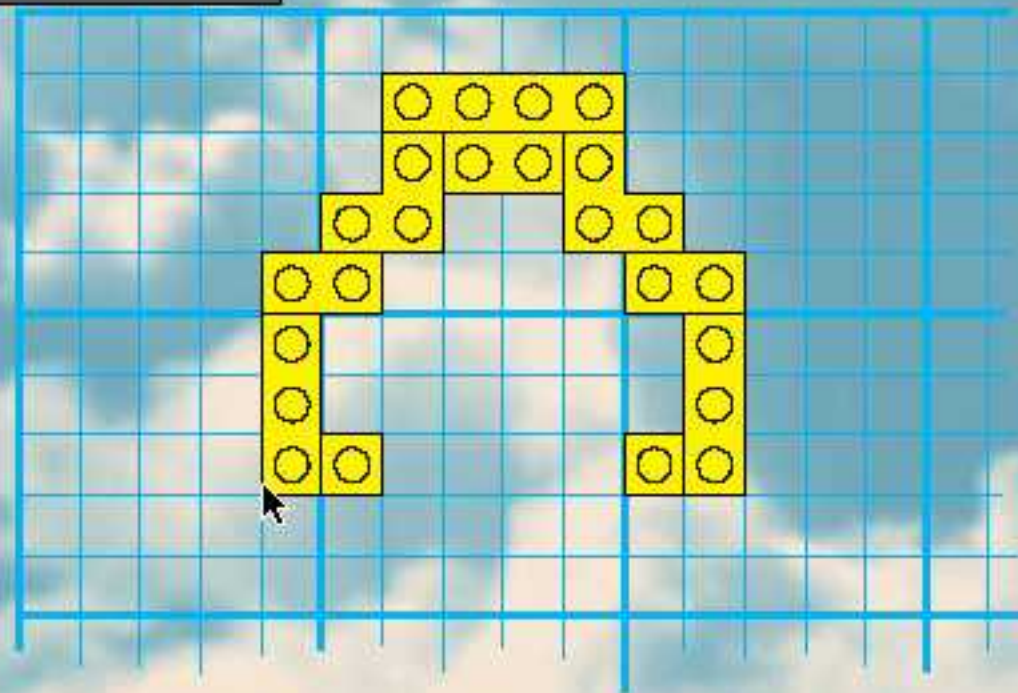
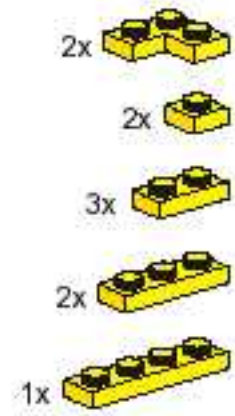

7

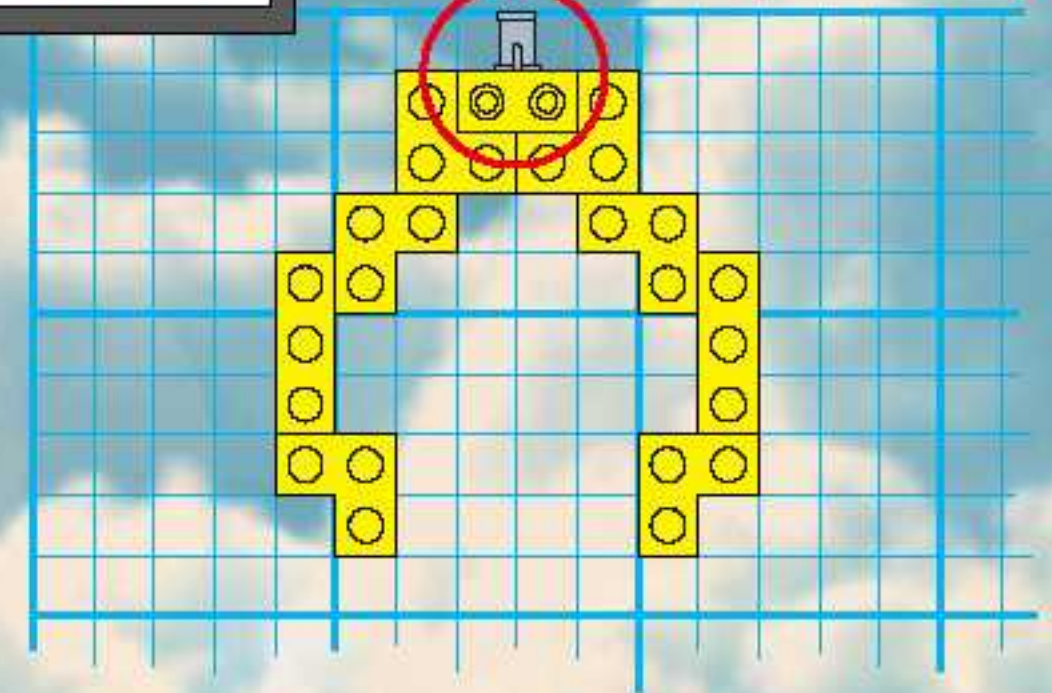
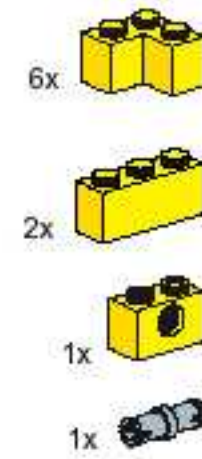

8

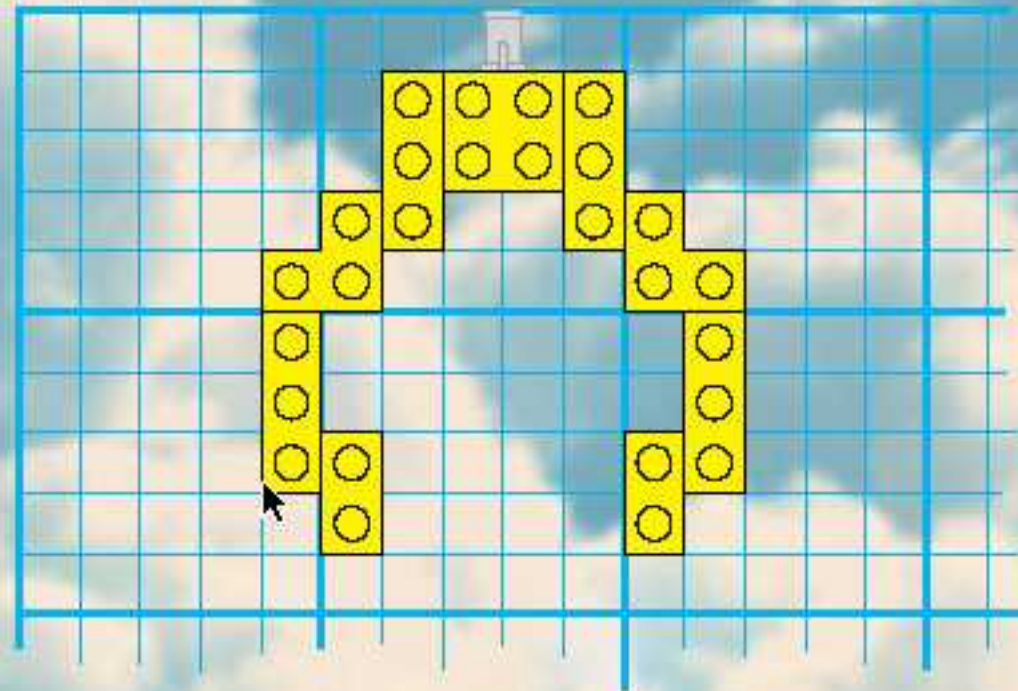

9

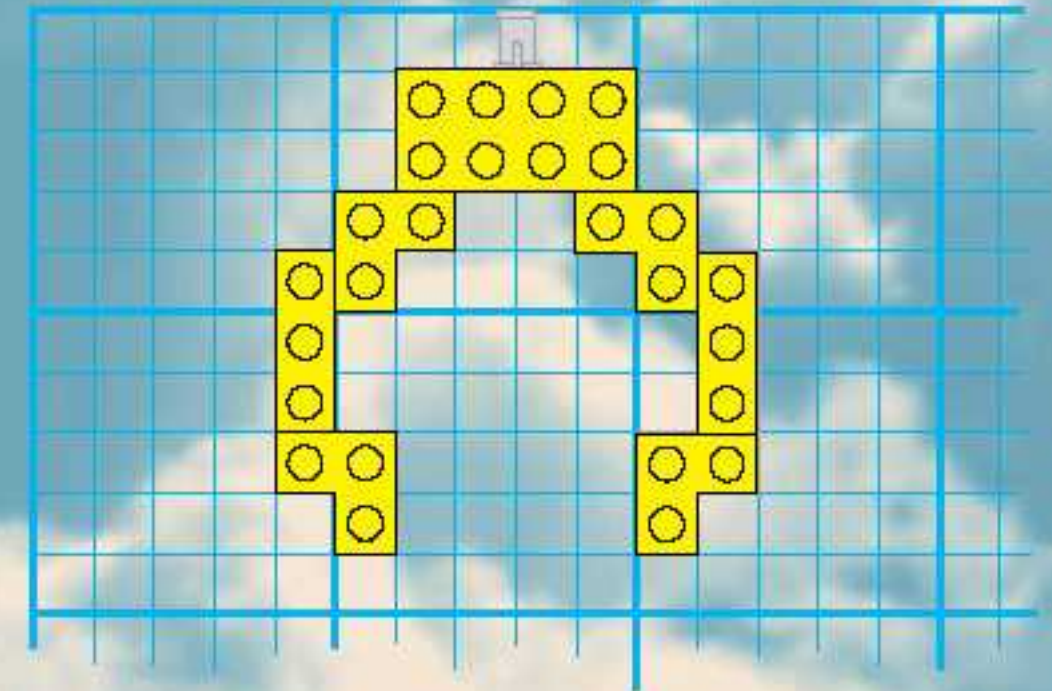

10

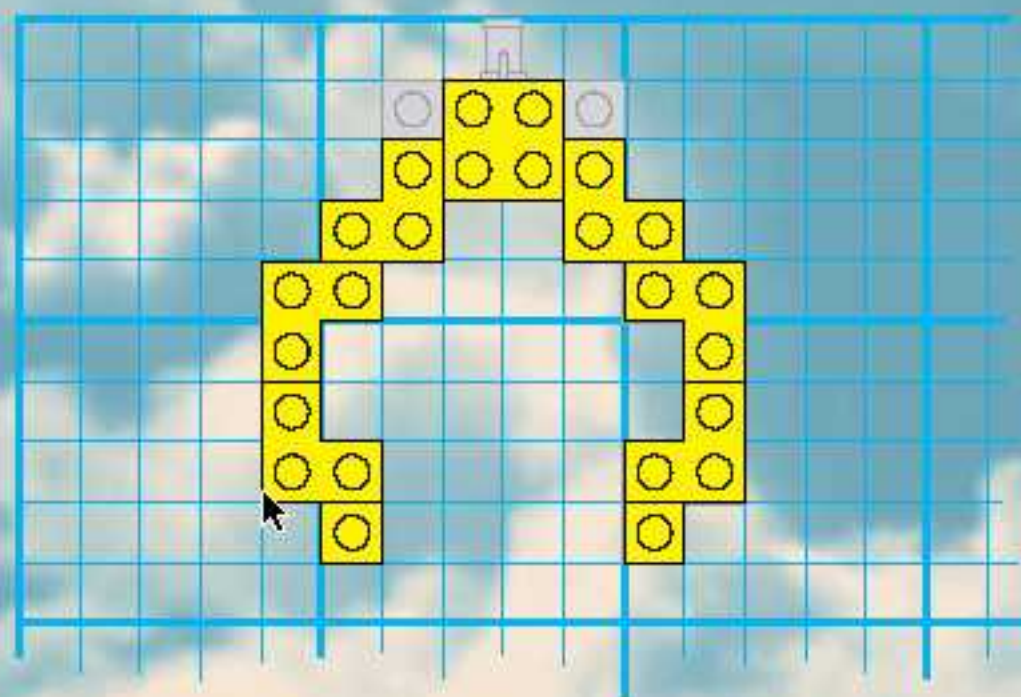

11

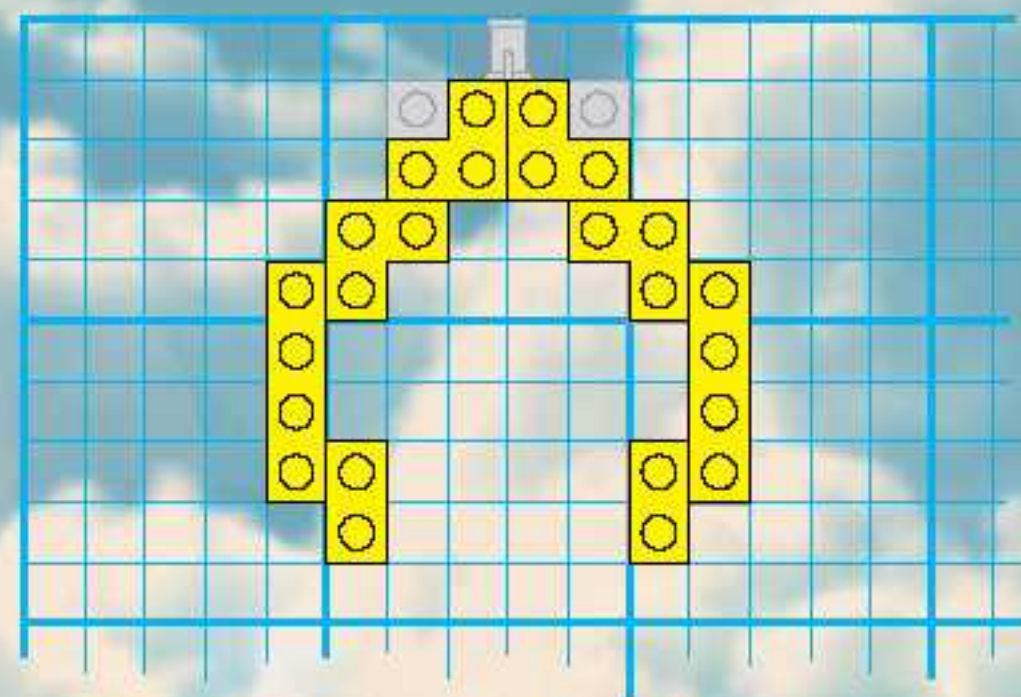

12

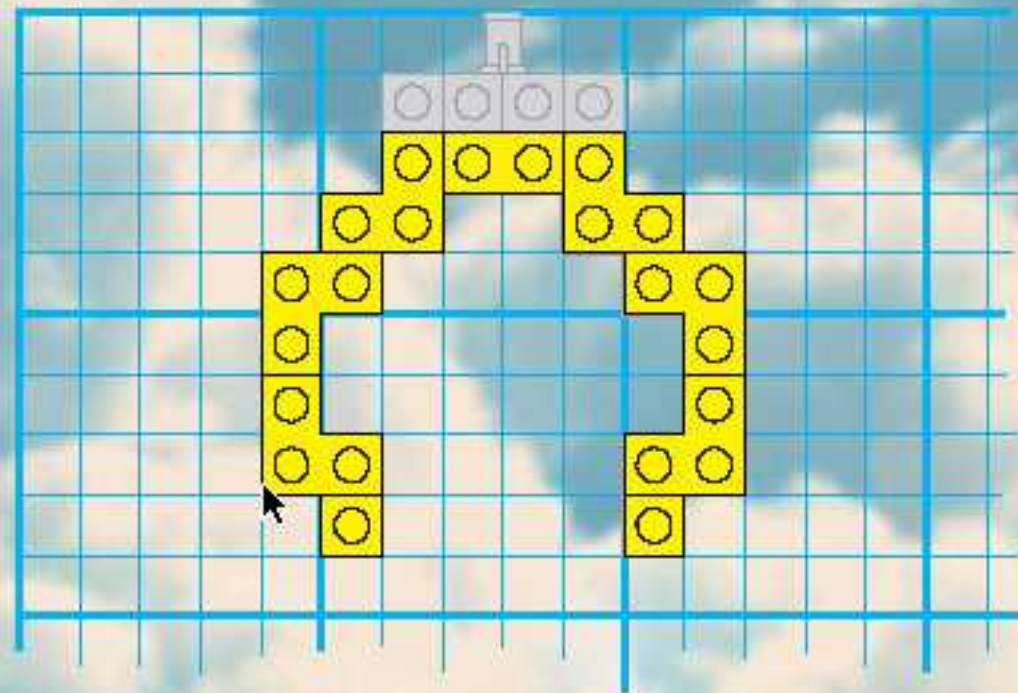

13

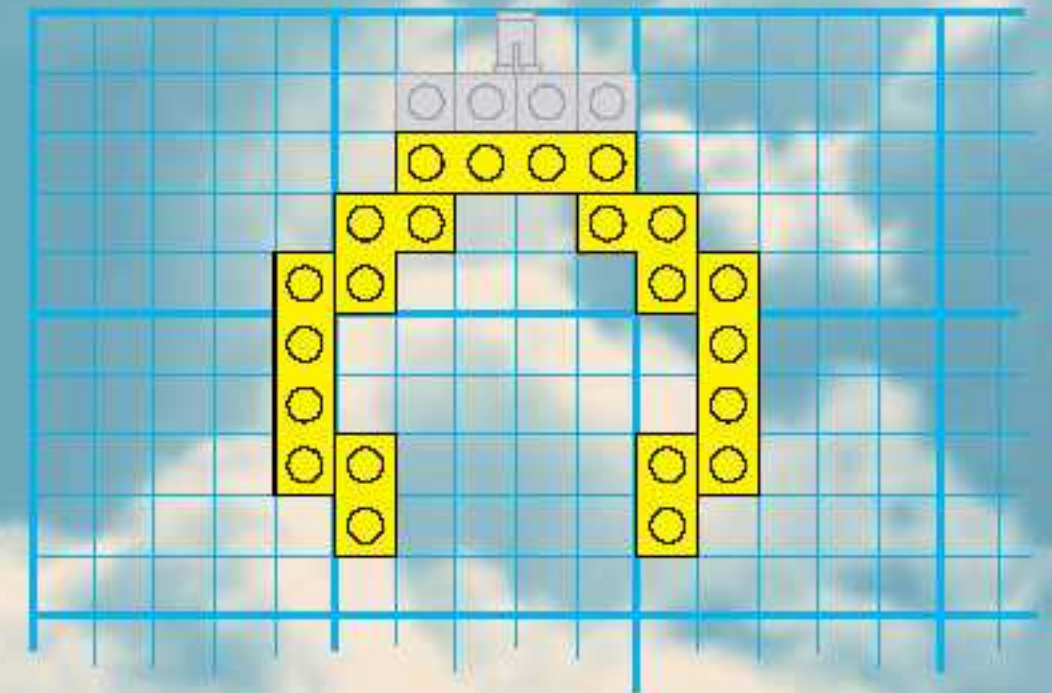



A

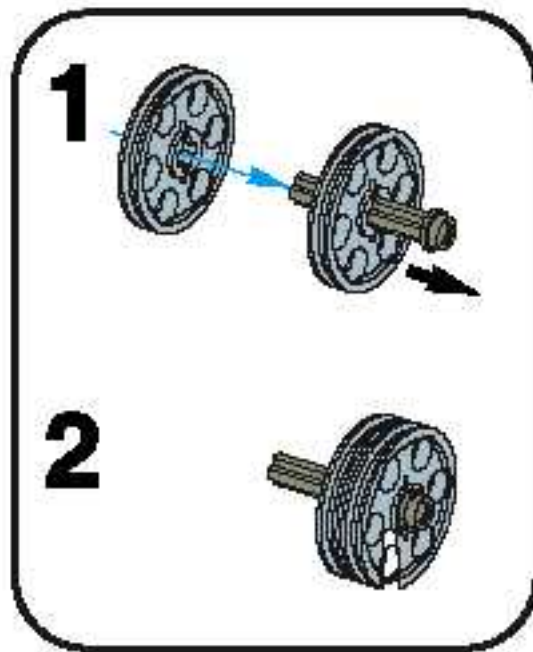
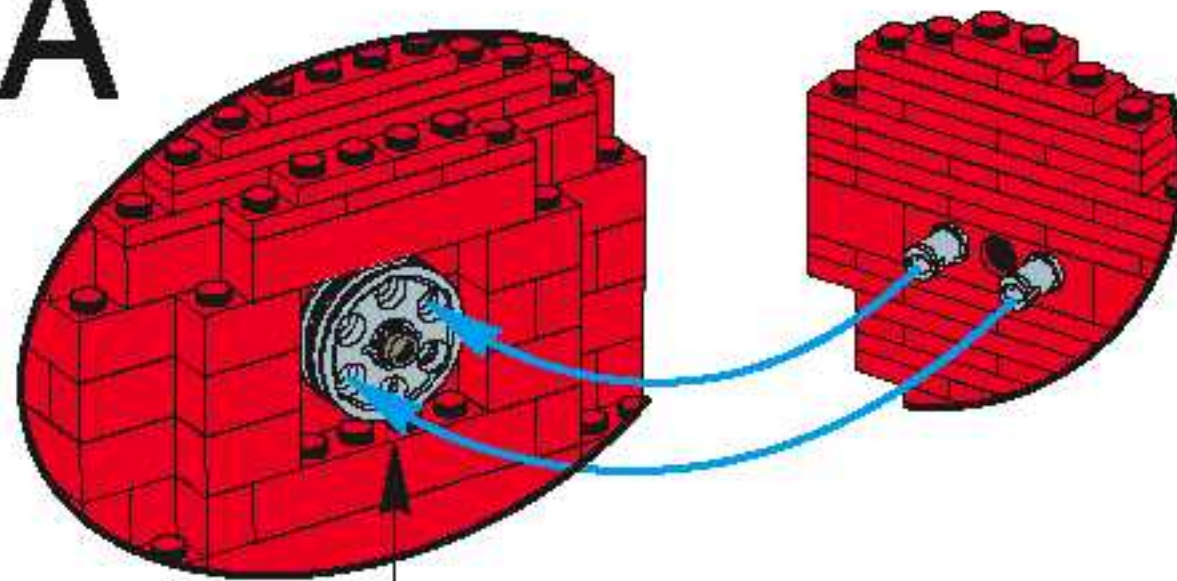

B

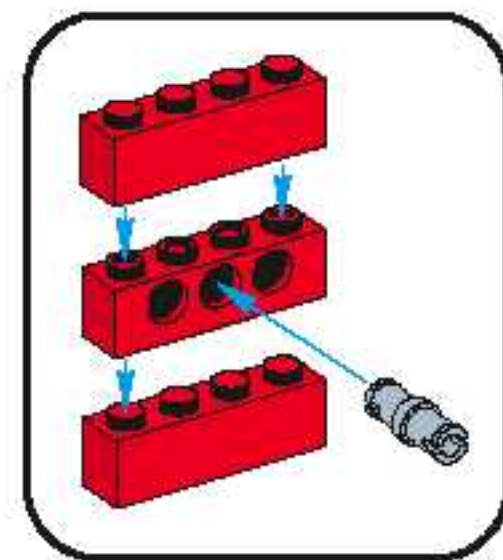
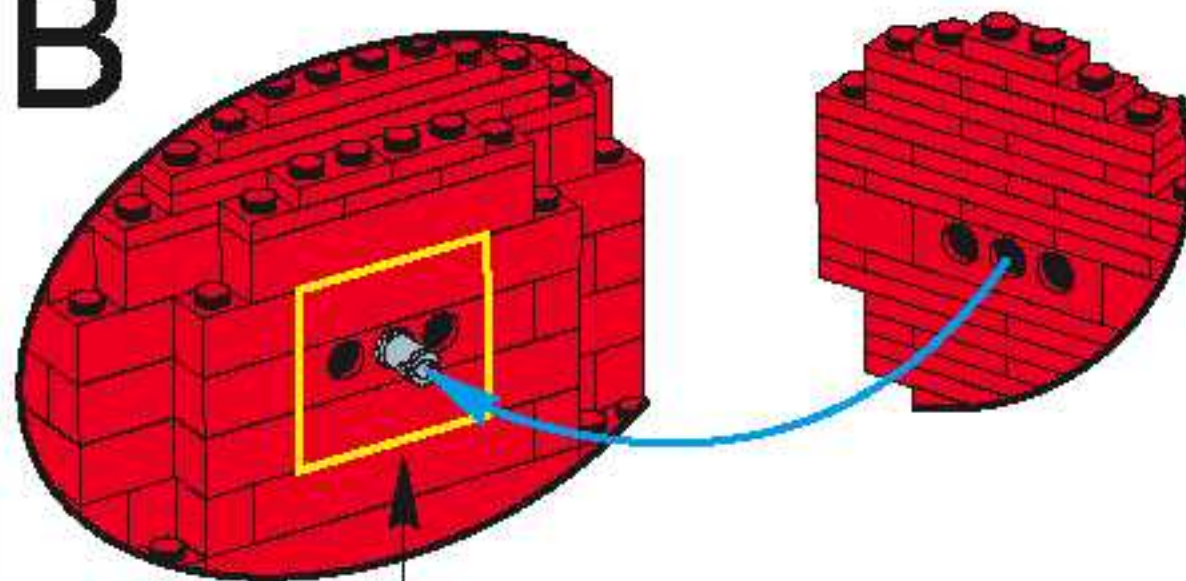



3450 STATUE OF LIBERTY
NOVEMBER 2000







just imagine...