

There is Power Mobility. And then there's

POWERFUL MOBILITY

Gypsy Q2

Owner's Manual



TABLE OF CONTENTS

1.	SAFETY GUIDELINES	2
2.	SAFETY NOTICE	9
3.	PARTS INTRODUCTION	10
4.	FOLDING EXPAND/FOLD THE SCOOTER	12
5.	BAGGAGE HANDLE THE SCOOTER	13
6.	OPERATION	17
	6.1 Control panel.	
	6.2 How to operate your scooter.	
	6.3 How to set Freewheel mode.	
7.	BATTERY CHARGING AND CARE	21
	7.1 Charging the battery.	
	7.2 Battery.	
8.	INSPECTION AND MAINTENANCE	23
	8.1 Inspection.	
	8.2 Regular checking record.	
	8.3 Storage.	
	8.4 Moving about.	
9.	TROUBLE SHOOTING AND SPECIFICATION	26
10.	BATTERY CHARGER AND BATTERY	28
11.	DIAGRAM	29
12.	WARRANTY	30

INTENDED USE

The device is intended for medical purposes to provide mobility to persons restricted to a sitting position.

SAFETY NOTES:

The product is not intended for visually impaired.

The drivers need to be mentally and physically suitable to drive the scooter.

The fingers need to work functionally.

The device can't be used by children until age of 12 without Parent or Professional approval.

The driving distance will be reduced if the power scooter is used frequently on slopes, rough ground or to climb kerbs.

To prevent injury to yourself or others, always ensure that the power is switched off when getting on or off of the scooter.

NOTE: This owner's manual is compiled from the latest specifications and product information available at the time of publication. We reserve the right to make changes as they become necessary. Any changes to our products may cause slight variations between the illustrations and explanations in this manual and the product you have purchased. The latest/current version of this manual is available on our website.

NOTE:

Maximum user weight: 115 kg; Classified in Class A (EN12184)

The scooter seat passed the ignition test (EN1021-1, -2 , ISO7176-16)

SAFETY GUIDELINES

Please carefully read this owner's manual before using the scooter. Improper use of the scooter could result in harm, injury or traffic accidents. Therefore, for maximum pleasure while using the scooter please read this owner's manual.

- ◆ This owner's manual includes operation instructions for every aspect of the scooter, assembly instructions, as well as instructions for how to deal with possible accidents.
- ◆ The symbols used in this manual are explained below:
Read especially the notes marked with these symbols-



WARNING! Indicates a potentially hazardous condition/situation. Failure to follow designated procedures can cause either personal injury, component damage, or malfunction. On the product, this icon is represented as a black symbol on a yellow triangle with a black border.



MANDATORY! These actions should be performed as specified. Failure to perform mandatory actions can cause personal injury and/or equipment damage. On the product, this icon is represented as a white symbol on a blue dot with a white border.



PROHIBITED! These actions are prohibited. These actions should not be performed at any time or in any circumstances. Performing a prohibited action can cause personal injury and/or equipment damage. On the product, this icon is represented as a black symbol with a red circle and red slash.

- ◆ This manual includes a copy of repair and maintenance record chart and warranty information. Please keep it in a safe place or in the scooter.
- ◆ If someone else uses the scooter, please make sure that you provide them with the instruction manual for his or her consideration.
- ◆ As designs change some illustrations and pictures in the manual may not correspond to the scooter that you purchased. We reserve the right to make design modifications.

Our scooters have been designed and manufactured to provide a comfortable and secure yet affordable solution for some mobility requirements.



Suggestion

To maximize your batteries efficiency and service life, please fully recharge your new battery before its first-time use.

SAFETY NOTICE

GENERAL



MANDATORY! Do not operate your new Scooter for the first time without completely reading and understanding this owner's manual and the Consumer Safety Guide.

Your Scooter is a state-of-the-art life-enhancement device designed to increase mobility. We provide an extensive variety of products to best fit the individual needs of the Scooter user. Please be aware that the final selection and purchasing decision regarding the type of Scooter to be used is the responsibility of the Scooter user who is capable of making such a decision and his/her healthcare professional (i.e., medical doctor, physical therapist, etc.).

The contents of this manual are based on the expectation that a mobility device expert has properly fitted the Scooter to the user and has assisted the prescribing healthcare professional and/or the authorized Provider in the instruction process for the use of the product.

There are certain situations, including some medical conditions, where the Scooter user will need to practice operating the Scooter in the presence of a trained attendant. A trained attendant can be defined as a family member or care professional specially trained in assisting a Scooter user in various daily living activities.

As you begin using your Scooter during daily activities, you will probably encounter situations in which you will need some practice. Simply take your time and you will soon be in full and confident control as you maneuver through doorways, on and off elevators, up and down ramps, and over moderate terrain.

Additional general information can be found on the supplemental information sheets and booklets included in your Owner's Package. Please fully read and review the information, and keep it readily available for future reference.

Below are some precautions, tips, and other safety considerations that will help you become accustomed to operating the Scooter safely.

■ PRE-RIDE SAFETY CHECK

Get to know the feel of your Scooter and its capabilities. We recommend that you perform a safety check before each use to make sure your Scooter operates smoothly and safely.

■ Perform the following inspections prior to using your Scooter:

- ◆ Check the condition of the tires. Make sure they are not damaged or excessively worn.
- ◆ Check all electrical connections. Make sure they are tight and not corroded.
- ◆ Check all harness connections. Make sure they are secured properly.
- ◆ Check the brakes to ensure they operate properly.
- ◆ Check the battery condition meter to ensure the batteries are fully charged.
- ◆ Ensure the manual freewheel lever is in drive mode before sitting on the Scooter.

If you discover a problem, contact your authorized Provider for assistance. Please refer to the Contact Information insert in your Owner's Package.

SAFETY NOTICE

■ BEFORE DRIVING

The user needs to be familiar with the usage and operation of this Scooter before driving. Therefore, please always keep the following safety notices in mind.

■ The same traffic rules apply to the use of this Scooter as apply to pedestrians

For your safety, please therefore follow the rules that apply to pedestrians.

- ◆ Drive on the pavement, single carriage roads, or pedestrian areas only. Never drive on motorways or dual carriageways.
- ◆ Please do not drive your Scooter after consuming alcohol or when you are tired.
- ◆ Please be careful when driving your Scooter in low light. It has not been designed for use at night.
- ◆ The Scooter may only be used on the pavement or pedestrian areas at 6mph. Use the 6mph switch to ensure you keep within this limit.

■ Practice operating your Scooter

Before using the Scooter in busy or potentially dangerous areas, familiarize yourself with the operation of your Scooter. Please practice in a wide-open area like a park. In order to avoid accidents with your Scooter driving, please bear in mind the different driving motions, such as accelerating, stopping, turning, reversing, up-and down ramps.

- ◆ Please turn the speed dial to turtle mark for your initial practice.
- ◆ Be sure someone accompanies you for safety when driving on the roads for the first time.
- ◆ Only use higher speed setting when you are confident that you can easily operate and control your Scooter.

■ The Scooter is only to be used by one person at a time

Do not carry passengers on your Scooter. (including children)

■ Do not use this Scooter to carry or haul goods

- ◆ The maximum weight can be carried, please refer to “MAX LOAD WEIGHT” in “9. SPECIFICATION”

■ Temperature

- ◆ Some of the parts of the scooter are susceptible to change in temperature. The battery can only operate in temperature that ranges between 10°C ~ 45°C.
- ◆ At extreme low temperatures, the batteries may freeze, and your scooter may not be able to operate. In extreme high temperatures it may operate at slower speeds due to a safety feature of the controller that prevents damage to the motors and other electrical components.
- ◆ DO NOT touch the motor after driving. It is hot.
- ◆ Surface temperatures can increase when exposed to external sources of heat (e.g. sunlight).

SAFETY NOTICE

■ WHILE DRIVING

■ **Please carry out daily inspections.** Refer to the section entitled “DAILY CHECKING”

■ Do not move your body out of the scooter while moving

- ◆ Such action may cause you to lose balance and risk injury from falling.
- ◆ Pay attention that your clothes do not tangle in the wheels.

■ Do not use your scooter under the circumstances below.

- ◆ On roads with heavy traffic or roads that are muddy, gravelly, bumpy, narrow, snowed over, icy, or canal towpaths not guarded by any fence or hedge. Keep away from places where you might get the wheels stuck.
- ◆ Do not drive at night or when it is raining, snowing, misty, or windy.
- ◆ Do not drive your scooter in an “S” pattern or make a sharp turn.
- ◆ Do not take the scooter onto escalators.
- ◆ UNDER NO CIRCUMSTANCES SHOULD THE SCOOTER BE USED AS A SEAT IN A MOTOR SCOOTER (E.G. CARS, BUSES, TRAINS, ETC).

■ About Mobile Phones and other electrical equipment

- ◆ Do not use a mobile phone or other wireless communication devices while driving.
- ◆ Always switch off the scooter and remove the ignition key before using a mobile phone.
- ◆ Do not charge the mobile phone or any other electrical devices from your scooter’s battery.

■ Automatic Power Shut Down

In order to avoid accidental battery run down, your scooter is equipped with an automatic power shut down facility. If the scooter is switched on, after remaining undisturbed for a period of thirty minutes it will automatically turn off. Should this occur, simply pull out the key to switch your scooter off and insert the key and it will be ready to use once again.

■ Ramps, inclines and drops

- ◆ Do not drive onto steep ramps greater than the specified gradient. Refer to the section entitled “CLIMBING ANGLE” in “9. SPECIFICATION”
- ◆ Always use a low speed setting when ascending or descending a gradient.
- ◆ Do not drive on roads with large drops or potholes.
- ◆ Please slow down when driving on roads with inclines.
- ◆ Do not make sudden turns when driving on gravel roads or ramps.
- ◆ Always lean forward when climbing a steep gradient.

■ Warning

The scooter might disturb the operation of devices in its environment that emit electromagnetic fields (e.g. alarm systems of shops, automatic doors, etc.); The driving performance of the scooter can be influenced by electromagnetic fields (e.g. those emitted by portable telephones or electricity generators).

SAFETY NOTICE

■ Starting and Driving

1. Make sure the seat is positioned properly.
2. Make sure the tiller has been secured properly.
3. Turn the power switch to “ON”.
4. Check battery indicator to see whether there is enough power for your journey. If you have any doubt about the remaining power, please recharge the batteries before departure.
5. Set the speed dial to a position you feel safe and comfortable with.
6. Check the forward/reverse speed lever works correctly.
7. Make sure the electromagnetic brake works correctly.
8. Make sure it is safe around you before you drive on the street.

WARNING!



- Do not set in the freewheel mode when driving on a gradient.
- Always re-engage the anti-freewheel device before use. Fail to do so may result in injury.
- To protect your safety, the power will automatically cut off and electromagnetic brake system will activate while you are driving down a steep gradient. This will limit the speed to a safe level. Turn the power on again to re-start your scooter.

Maximum User Weight Limit

- Refer to section entitled “MAX. USER WEIGHT” in “ 8. SPECIFICATION “. Overloading past the weight limit may lead to damage of your scooter or cause it to malfunction and will endanger your safety. The warranty does not cover this type of damage.



Attention

1. Do not turn the power switch to OFF while driving as this will lead to an emergency stop and possible risk of accident and injury.
2. Do not set to the highest speeds while driving indoors.
3. Do not adjust the speed dial while driving, a sudden change in speed may cause danger to you and others, and may cause damage to your scooter.
4. Do not place magnetic devices near the area of the operation handle as this could affect the safe operation of your scooter.
5. Do be careful while driving in heavy traffic or crowded areas.
6. While reversing the scooter, beware of people or objects behind you.

SAFETY NOTICE

■ Stopping

1. Release the speed control lever completely. The scooter will naturally brake and stop.
2. Turn the power switch to (OFF). Then pull out the key.

■ Driving on the pavement

- ◆ Ensure the 6.4 km/h limit switch is set to the slowest setting when using the scooter on the pavement.
- ◆ This will limit the scooter to a maximum speed of 6.4 km/h. It is an offence to travel at more than 6.4 km/h on the pavement.
- ◆ The limit switch can be set to the fastest setting for use on the road or on private ground.

■ Motor Vehicle Transport

Wu's recommend that you do not remain seated in your scooter while traveling in a motor vehicle. The scooter should be stowed in the trunk of a car or in the back of a truck or van with the batteries removed and properly secured.



WARNING! Do not sit on your scooter while it is in a moving vehicle.

WARNING! Always be sure your scooter and its batteries are properly secured when it is being transported. Batteries should be secured in an upright position and protective caps should be installed on the battery terminals. Batteries should not be transported with any flammable or combustible items.

■ Lift/Elevation Products

If you will be transporting your scooter during travel, you may find it necessary to use a vehicle-mounted lift system or elevation product to aid in transportation. Wu's recommends that you closely review the warnings, instructions, specifications, and safety information set first by the manufacturer of the lift/elevation product before using that product.



WARNING! Always turn off the power to the unit when you are being transferred via an elevation product. Failure to do so may result in accidental throttle control lever contact, resulting in unintended movement and personal injury or product damage.

■ Stairs and Escalators

Scooters are not designed to travel up or down stairs or escalators. Always use an elevator.



DO not use your scooter to negotiate steps or escalators.

SAFETY NOTICE

■ LABELING

Please carefully read all labels on the scooter before driving it. For your future reference, do not remove them.

1. WARNING EMI LABEL.....



2. FREEWHEEL LABEL.....



3. TILLER DUMPING WARNING LABEL.....

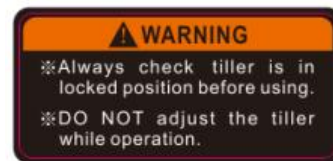

4. PINCH WARNING LABEL.....



5. CHARGING VOLTAGE LABEL.....



SAFETY NOTICE

■ EMI

This portion of the content will provide the user with basic information that describes the problems with EMI, known sources of EMI, protective measures either to lessen the possibility or exposure or to minimize the degree of exposure, and suggested action should unexpected or erratic movement occur.



Caution:

It is very important that you read this information regarding the possible effects of electromagnetic interference on your electric scooter.

■ ELECTROMAGNETIC INTERFERENCE (EMI) FROM RADIO WAVE SOURCES

Electrical scooter may be susceptible to electromagnetic interference (EMI), which is interfering electromagnetic energy (EM) emitted from sources such as radio stations, TV stations, amateur radio (HAM) transmitters, two-way radios, and cellular phones. The interference (from radio wave sources) can cause the Electrical scooter to release its brakes, move by itself, or move in unintended directions. It can also permanently damage the Electrical scooter's control system. The intensity of the interfering EM energy can be measured in volts per meter (V/m). Each Electrical scooter can resist EMI up to a certain intensity. This is called its "immunity level". The higher the immunity level, the greater the protection. At this time, current technology is capable of achieving at least a 20 V/m immunity level, which would provide useful protection from the more common sources of radiated EMI. This Electrical scooter model as shipped, with no further modification, has an immunity level of 20 V/m without any accessories.

There are a number of sources of relatively intense electromagnetic fields in the everyday environment. Some of these sources are obvious and easy to avoid. Others are not apparent and exposure is unavoidable. However, we believe that by following the warning listed below, your risk to EMI will be minimized.

The sources of radiated EMI can be broadly classified into three types:

1. Hand-held portable transceivers (transmitter-receivers with the antenna mounted directly on the transmitting unit. Examples include citizens band (CB) radios, "walkie talkie", security, fire, and police transceivers, cellular telephones and other personal communication devices.
2. Medium-range mobile transceivers, such as those used in police cars, fire trucks, ambulances and taxis. These usually have the antenna mounted on the outside of the Scooter,
3. Long-range transmitters and transceivers, such as commercial broadcast transmitter (radio and TV broadcast antenna towers) and amateur (HAM) radios;

■ The wheelchair and/or battery charger meet the requirements of ISO 7176-21 : 2009.

PARTS INTRODUCTION

■ PARTS DESCRIPTION

- | | | |
|--------------------------|-----------------------|-------------------------|
| 1. Control Panel | 2. Speed lever | 3. Slide Lever |
| 4. Tiller Swivel Knob | 5. Seat | 6. Charger Socket Cover |
| 7. Front Footrest | 8. Speed switch knob | 9. Rear Reflector |
| 10. Freewheel mode lever | 11. Seat folding knob | 12. Seat folding lever |



FOLDING UP/OUT THE SCOOTER

1. Backrest folding step description.



2. Pull the yellow knob back to lift up the tiller.

3. Fold the backrest first, and press the seat folding knob and lever to push the seat back.

(Folding up the scooter p.3)



4. Push the support rod forward to make the bottom smooth, then press the pedal.

5. Push up the pedal, position the pedal plate forward. (Folding up the scooter p.2)



6. Lift up the seat.

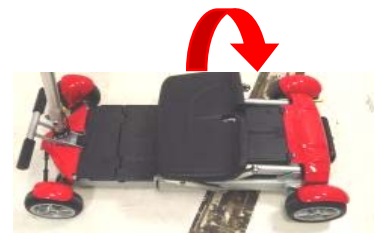

7. Adjust slide lever down to suitable position. (Folding up the scooter p.4)



FOLDING UP/OUT THE SCOOTER

8. Adjust slide lever up to suitable position.



9. Pull the yellow knob back to put down the tiller. (Folding up the scooter p.1)

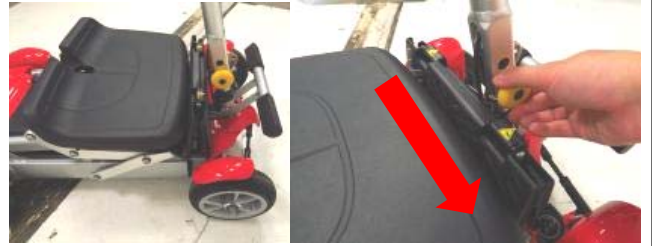

10. Complete.



11. Complete.



BAGGAGE HANDLE THE SCOOTER

■ How to use baggage handle

1. Push the luggage buckle to the right to allow the luggage handle to move easily.



2. Pull the luggage handle to the top.

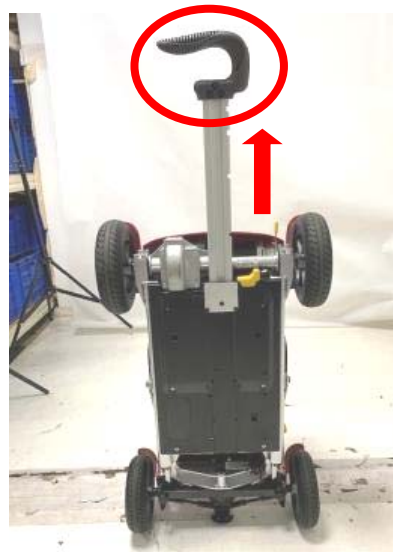

3. The trunk buckle and the bottom of the handle will automatically fasten, then complete.

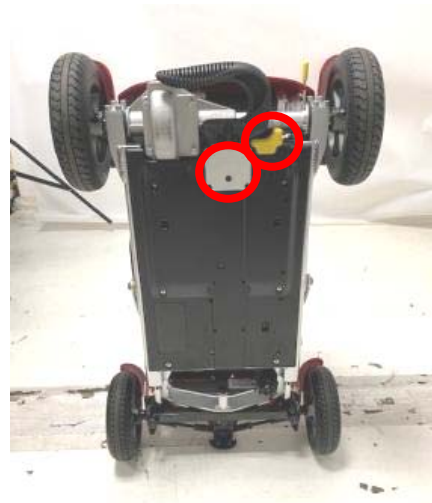

Note: The restore steps will return in order.

OPERATION

■ 6.1 CONTROL PANEL (Occupant and assistant can operate)

1. Battery Level Indicator
2. Speed Lever
3. Forward / Reverse Selector



PROHIBITED! Do not expose the tiller console to moisture. In the event that the tiller console does become exposed to moisture, do not attempt to operate your Scooter until the tiller console has dried thoroughly.

■ 6.2 HOW TO OPERATE YOUR SCOOTER

■ Power switch

Insert or pull out the key to power ON or OFF
(ON / Insert) : Power is turned on
(OFF / Pull) : Power is turned off



WARNING!

If the key is moved to the “off” position while your Scooter is in motion, the electronic brakes will engage and your Scooter will come to an abrupt stop!

Event of an emergency, pull off the key (the key is an emergency stop device)

DO NOT operate the scooter if it is behaving abnormally or erratically

■ Speed Dial (occupant and assistant can operating)

This dial allows you to preselect and limit your Scooter’s top speed.

- ◆ The image of the tortoise represents the slowest speed setting.
- ◆ The image of the hare represents the fastest speed setting.



OPERATION

■ Forward, Reverse, and Braking (Only the occupant can operate)

- ◆ The button controls upwards with your left fingers and pull the scooter will move forward.
- ◆ The button control downwards with your left fingers and pull the scooter will move backward.
- ◆ Release the speed control lever freely while either going forward or reverse, and the electromagnetic brake in the motor will be activated, and the scooter will stop.
- ◆ Parking brake can be referred while free wheel lever is at engaged status, also ensure lever is engaged while parking in the slope.

■ Battery Indicator

- ◆ When the power switch is turned on the battery indicator will light up with show color squares the remaining battery power. The “green” means full power, the “red” means off power.
- ◆ The remaining power indicated by the battery indicator will vary by the actual driving time incurred and how you drive. Repeated starting, stopping, climbing will consume the power more quickly.



Warning!

Do not operate the Scooter with depleted batteries, since the occupant could be stranded.



- ◆ The remaining power suggested by the battery indicator will vary by the actual driving time incurred and how you drive. Repeated starting, stopping, climbing will consume the power more quickly.
- ◆ If the power down timer feature takes effect, perform the following steps to resume normal operation.
 1. Remove the key from the key switch.
 2. Reinsert the key and power up your Scooter.

OPERATION

■ How To Set Freewheel Mode (Only the assistant can operate)

Whenever you need or want to push your Scooter for short distances, you can put it in freewheel mode.

1. Locate the manual freewheel lever at the top right of the rear section.
2. Push forward on the manual freewheel lever to disable the drive system and the brake system. You may now push your Scooter.
3. Push the manual freewheel lever rearward to reengage the drive and the brake systems; this takes your Scooter out of freewheel mode.
4. Ensure free wheel lever is engaged in the 'DRIVE' position.
5. Ensure free wheel lever is disengaged in the 'NEUTRAL' position.
6. Parking brake is in free wheel mode (Neutral position)

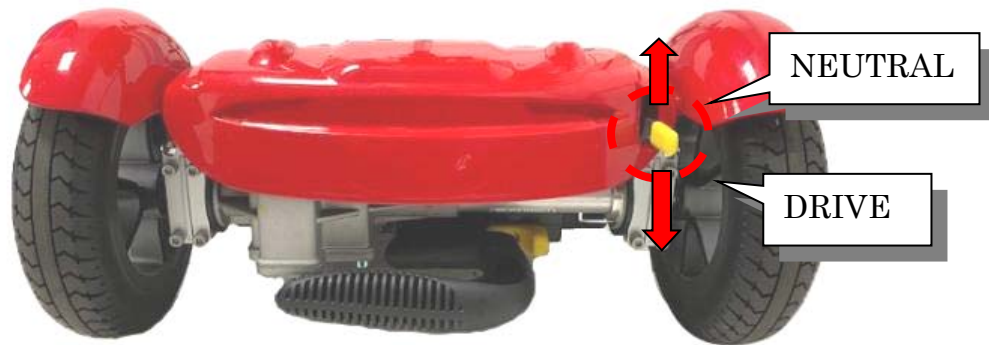

WARNING!

When your Scooter is in freewheel mode, the braking system is disengaged.

- Disengage the drive motors only on a level surface.
- Ensure the key is removed from the key switch.
- Stand to the side of the scooter to engage or disengage freewheel mode. Never sit on a scooter to do this.
- After you have finished pushing your scooter, always return it to the drive mode to lock the brakes.



WARNING!

Before placing your Scooter into or taking it out of freewheel mode, remove the key from the key switch. Never sit on a Scooter when it is in freewheel mode. Never put a Scooter in freewheel mode on any incline.

BATTERY CHARGING AND CARE

■ 7.1 CHARGING THE BATTERY

Follow the procedure below step by step:

1. Turn the power switch to (OFF)
2. Connect the charger's power cord into the power outlet.
3. Open the charging socket cap on the battery pack. Then connect the charger's round plug to the charging socket.
4. Turn on the switch on the charger.
5. The charger's red LEDs will be lit when beginning charging. The charging duration is about 6 hours. To ensure optimum performance, a 10-hour charge is recommended. But we do not recommend a charging more than 24 consecutive hours.
6. The charger's red LEDs will be lit during the charging process. The red LED will turn green when charging is complete.
7. Turn off the charger; disconnect the power cord and the round plug from charger socket on the scooter.



This charger meets IP21 (The charger detail specifications. Refer to the "BATTERY CHARGER AND BATTERY")

📖 Suggestions

There is a charger inhibit function on your scooter. The scooter will not run and the battery condition meter will not operate while the batteries are charging.



WARNING!

1. **To prolong charger life, do not connect the short output for long time.**
2. **Though charger charge automatically and can be used for deeply discharged battery, do not use for extremely discharged, short aged and defective battery.**
3. **Use the charger in a well-ventilated area.**
4. **Use for Lithium batteries 25.2V.**
5. **Do not use for voltage input except the specified.**
(Make sure your present voltage input 110V or 240V and adjust manually)

■ 7.2 BATTERY

- ◆ Do not expose the battery to temperatures below 10°C or above 50°C when charging or storing the scooter. Under the above temperature range can cause the battery either to freeze or over-heat. This will damage the batteries and shorten their life.
- ◆ These batteries are maintenance free and there is no need to refill with water.
- ◆ You are required to recharge the batteries on a regular basis. Even if the scooter is stood idle, you should charge the batteries at least once a week.
- ◆ The batteries carry a six-month manufacturer's warranty. This warranty only covers issues relating to manufacturing faults, and not faults relating to failure to recharge the batteries as instructed above.

Suggestion – How to maximize your batteries efficiency and service life

1. Fully recharge your new battery before its first-time use.
2. Be sure to charge the battery fully every time. The battery life will be seriously shortened or decayed if the battery is repeatedly used without being fully charged.
3. Always complete the charging until the orange LED light turns green. NEVER stop charging before it is complete.
4. Keep your batteries fully charged whenever possible.
5. If you do not use your scooter for a long time, it should be charged at least every week to keep the battery in a fully usable condition.
6. The ambient temperature will affect charging time. Charging time will be longer in the winter.
7. After charging, do not leave the charger socket plugged in to the scooter, as this will cause a power drain on the scooter and temporarily reduce its range.

BATTERY CHARGING AND CARE



PROHIBITED! Removal of grounding prong can create electrical hazard. If necessary, properly install an approved 3-pronged adapter to an electrical outlet having 2-pronged plug access.



PROHIBITED! Never use an extension cord to plug in your battery charger. Plug the charger directly into a properly wired standard electrical outlet.



PROHIBITED! Do not allow unsupervised children to play near the Scooter while the batteries are charging. We recommend that you do not charge the batteries while the Scooter is occupied.



MANDATORY! Read the battery charging instructions in this manual and in the manual supplied with the battery charger before charging the batteries.



WARNING! Explosive gases may be generated while charging the batteries. Keep the Scooter and battery charger away from sources of ignition such as flames or sparks and provide adequate ventilation when charging the batteries.

WARNING! You must recharge your Scooter's batteries with the supplied off-board charger. Do not use an automotive-type battery charger.

WARNING! Inspect the battery charger, wiring, and connectors for damage before each use. Contact your authorized Provider if damage is found.



WARNING! Do not attempt to open the battery charger case. If the battery charger does not appear to be working correctly, contact your authorized Provider.

WARNING! If the battery charger is equipped with cooling slots, then do not attempt to insert objects through these slots.

WARNING! Be aware that the battery charger case may become hot during charging. Avoid skin contact and do not place on surfaces that may be affected by heat.



WARNING! If your battery charger has not been tested and approved for outdoor use, then do not expose it to adverse or extreme weather conditions. If the battery charger is exposed to adverse or extreme weather conditions, then it must be allowed to adjust to the difference in environmental conditions before use indoors. Refer to the manual supplied with the battery charger for more information.

BATTERY CHARGING AND CARE

■ Cleaning the battery

If the batteries are contaminated by water, battery acid, dust or other substances, they will discharge quickly. The batteries supplied with the WU'S scooter are sealed and as such are maintenance free with no risk of battery leakage. Please follow the steps below to clean the battery.

1. Turn the scooter power switch to "OFF".
2. Use a clean cloth to wipe off the soiled area.
3. Take out the battery.
4. Clean the battery with a clean cloth. If the terminal is covered by white powder, please wipe it clean using warm water.

The wiring system is well situated in battery pack while assembled in plant. Do not attempt to re-locate the wiring system by yourself. The improper layout of wiring system may result in the wires pinched by battery box, which might the electronic system failure.



1. Be sure the battery wires are connected to their right battery terminal.
2. If necessary, ask for help from your dealer for advice about maintaining and replacing the battery.

📖 Suggestions

1. Make sure the terminals are installed properly and put the cover back on.
2. Do not use the battery to charge telecom equipment or other items.
3. Battery efficiency will vary with outside conditions; the driving distances will be shorter in the winter. If the scooter is not used for a long time, please charge the battery at least every week.

INSPECTION AND MAINTENANCE

■ 8.1 INSPECTION

- ◆ Clean the scooter with a damp cloth and dust down approximately once a week to preserve the appearance of the scooter.
- ◆ Adjust the tiller height and return to the original position once a week to ensure the parts can be adjusted smoothly and easily when required.
- ◆ Check for signs of wear and tear on the tires and the upholstery on a regular basis.
- ◆ For optimum performance and to increase the lifespan of your scooter, it is recommended that you have your scooter serviced once a year.

■ 8.2 REGULAR CHECKING RECORD

To make sure your scooter is correctly serviced, take it to your dealer for regular maintenance checks. This should be at intervals of six months after the first inspection after one month. Your dealer may charge a fee for this service.

YEAR	1	2	3	4	YEAR	1	2	3	4
Service Dates					Service Dates				
Controller					Upholstery				
On/off switch					Seat				
Controller Lever					Back				
Braking									
Recharge point					Electrics				
Batteries					Connections condition				
Levels									
Connections					Test run				
Discharge test					Forwards				
Wheels and Tyres					Reverse				
Wear					Emergency stop				
Bearings					Left turn				
Wheel nuts					Right turn				
					Slope test				
Motors					Over obstacles				
Wiring					List Items repaired				
Noise									
Connections									
Brake									
Brushes									
Chassis									
Condition									
Steering									

INSPECTION AND MAINTENANCE

■ Tires

The condition of the tires depends on how you drive and use your scooter.

- ◆ Inspecting tire tread
- ◆ Please check the tread groove regularly. Replace the tires when the tread groove is less than 0.5 mm.



Attention

1. When tread groove is below 0.5mm it can easily lead to scooter slippage, making braking distances longer. Therefore replace the tires as early as possible when they do not have insufficient tread depth.
2. When conducting maintenance of your scooter, please turn the power switch to OFF and remove the charger cords.

📖 Suggestions

- ◆ Do not splash water directly to wash your scooter as this could lead to malfunction of the system electrics.
- ◆ Do not use petrol, solvents or vaporizing solution as these may deform or damage the shrouds.

■ 8.3 STORAGE

Make sure the scooter is stored under the following circumstances:

- Make sure the seat is set in the “Forward” position.
- Make sure the Power switch is turned to OFF.
- Operating conditions please refer to Lithium battery specifications.

📖 Suggestion

Please store the scooter in a location where it is away from the direct sunlight, rain, or dew. When storing for a long time, please charge the battery to full power and then disconnect the battery terminal. For details inquire to your scooter dealer.

■ 8.4 MOVING ABOUT

- ◆ Turn the power switch “OFF” before moving.
- ◆ Lift the scooter by the chassis, and not by the bumpers. Lifting the scooters by the bumper could.
- ◆ cause damage or injury.
- ◆ For your safety, always ask for help if required. You will need 2 or 3 persons when moving or lifting the scooter.

TROUBLE SHOOTING AND SPECIFICATION

■ TROUBLE SHOOTING

Symptom	Remedy
The scooter will not switch on	<ul style="list-style-type: none"> • Try recharging the battery • Check the fuse and circuit breaker in the scooter
The scooter switches on, but the scooter will not move.	<ul style="list-style-type: none"> • Ensure there is enough power in the batteries. If not, recharge the batteries. • Ensure the freewheel lever is engaged in the 'DRIVE' position.
The scooter appears slow	<ul style="list-style-type: none"> • Check the battery power level and recharge • Check the speed dial is not set to slow.
The seat turns when in operation	<ul style="list-style-type: none"> • Slowly rotate the seat until it drops into place and is secure
The handlebar appears loose	<ul style="list-style-type: none"> • Tighten the height adjustment handle to secure the handlebar
Involuntarily horn sounds	<ul style="list-style-type: none"> • Ensure that the wigwag paddle is released. • Switch the scooter off and on. • Recharge the batteries. • If problem persists contact your WU'S dealer.

Warning: DO NOT editing program of control!

Flash Code	Description	Recommended Action
1	Low Battery	Recharge battery
2	Motor Fault	Check the motor connections, wiring and brushes
3	Wiring Fault	Check the connections/wiring between the motor and batteries
4	Brake Fault	Check the brake connections and wiring
5	Over temperature or current foldback	The controller is over temperature or in current foldback
6	Charger Fault	Disconnect the charger from the scooter
7	Throttle Fault	Make sure the throttle is not engaged when turning on the scooter
8	Controller Fault	Check the controller connections and wiring
9	Brake Fault	Check the brake connections and wiring
10	High Voltage	If driving downhill slow down and turn lights on. Test the charger to ensure that it cuts off when batteries are full charged.

TROUBLE SHOOTING AND SPECIFICATION

■ SPECIFICATION

Model Reference	GYPSY TA (for transaxle)
Scooter Size (L×W×H)	905 x 420 x 910 mm
Total Weight with Battery	21 kg
Battery Weight	1.85 kg
Tow handle Weight	0.4 kg
Front Wheel	165 x 50 mm, 6.5"x2pcs
Rear Wheel	185 x 50 mm, 7.5"x2pcs
Battery Specifications	11.6AH, Lithium-Ion Battery
Charger Type	Input AC100-240V, Output DC29.4V, 2 Amp
Motor Type	DC24V / 180W / 4700 RPM (1:21)
Turning Radius	1420 mm
Max Speed	6.4 km/h
Cruising Range	11.8 km
Weight Capacity	115 kg, 250 lbs
Max Climbing Angle	6°
Controller Type	Dynamic 50A

Remark: The manufacturer reserves the right to modify the specification if necessary. The final specification is subject to the individual scooter you purchase from your dealer.

Note:

Please note that the maximum range is based on an ambient temperature of 20°C, a 75kg driver, a brand new and fully charged battery, and a constant driving speed of 4/5 mph with 70% battery power discharged.

TROUBLE SHOOTING AND SPECIFICATION

Address: EV Rider, LLC, 6410 Arc Way, Suite A, Fort Myers, FL 33966

Model: GYPSY TA (for transaxle)

Maximum occupant mass: 250 lbs

GYPSY TA (for transaxle) is complied with ISO 7176-15

Disclosure information in manufacturer specification sheets per ISO 7176-15:1996							
Standard reference		Min.	Max.	Standard reference		Min.	Max.
ISO 7176-5	Overall length With legrest	—	905mm	ISO 7176-3	Minimum Braking distance From max speed	1100mm	1490mm
ISO 7176-5	Overall width	—	425mm	ISO 7176-7	Seat plane angle	—	8°
ISO 7176-5	Folded length	—	695mm	ISO 7176-7	Effective seat depth	—	200mm
ISO 7176-5	Folded width	—	420mm	ISO 7176-7	Effective seat width	—	340mm
ISO 7176-5	Folded height	—	310mm	ISO 7176-7	Seat surface height at front edge	—	490mm
ISO 7176-5	Total mass	—	19.8kg	ISO 7176-7	Backrest angle	—	—
ISO 7176-5	Mass of the heaviest part	—	17.86kg	ISO 7176-7	Backrest height	—	—
ISO 7176-1	Static stability downhill	—	15.7°	ISO 7176-7	Footrest to seat distance	—	340mm
ISO 7176-1	Static stability uphill	—	18.6°	ISO 7176-7	Armrest to seat distance	—	—
ISO 7176-1	Static stability sideways	—	7.4°	ISO 7176-7	Front location of armrest structure	—	—
ISO 7176-4	Energy consumption	11.65km	—	ISO 7176-5	Handrim diameter	—	—
ISO 7176-2	Dynamic stability uphill	—	6°	ISO 7176-5	Horizontal location of axle	—	740mm
ISO 7176-10	Obstacle climbing	20mm	40mm	ISO 7176-5	Minimum turning radius	1420mm	—
ISO 7176-6	Maximum speed forward	—	6.5Km/h	ISO 7176-5	Minimum turn-around Width	1500mm	—

BATTERY CHARGER AND BATTERY

Item	Specification	Descriptions		Remark
1	Model Number	LES-2401PF		
2	Cell	NCR18650PF		Cell:2900mAh
3	PCM	7S-27A		
4	Configuration	7S4P		
5	Capacity	11600mAh (Typ.)		
6	Nominal Voltage	25.2V		
7	Charge Max Voltage	29.4V – 0.15V		
8	Discharge Min Voltage	19.80V±0.5V		Each cell 2.8V
9	Charge Current	< 7A		
10	Discharge Current	< 30A		
11	Temperature (Recommended)	Charge	10~+45°C	
		Discharge	-20~+60°C	
12	Storage	Less than 30 days	-20~+50°C	
		Less than 180 days	-20~+40°C	
		Less than 1 year	-20~+20°C	
13	Humidity	Less than 70% RH		
14	Internal resistance	< 150mΩ		
15	Power Consumption	< 500μA		
16	Fuse	Discharge	40A	
17	Connector	Charge	94M-007P2-4PIN	
		Discharge	AMP 179958-2	
18	Cable length / AWG	UL1015#12AWG RED(+),		
		UL1015#12AWG BLACK(-),		
19	Outer Dimension	302mm*101mm*49.85mm		±0.5mm

■ Battery Recycling

- ◆ Lithium batteries are the environmental success story of our time because more than 97 percent of all battery lead is recycled.
- ◆ The WUS scooter is equipped lithium batteries; please contact your nearest distributor to properly recycle your batteries.

BATTERY CHARGER AND BATTERY

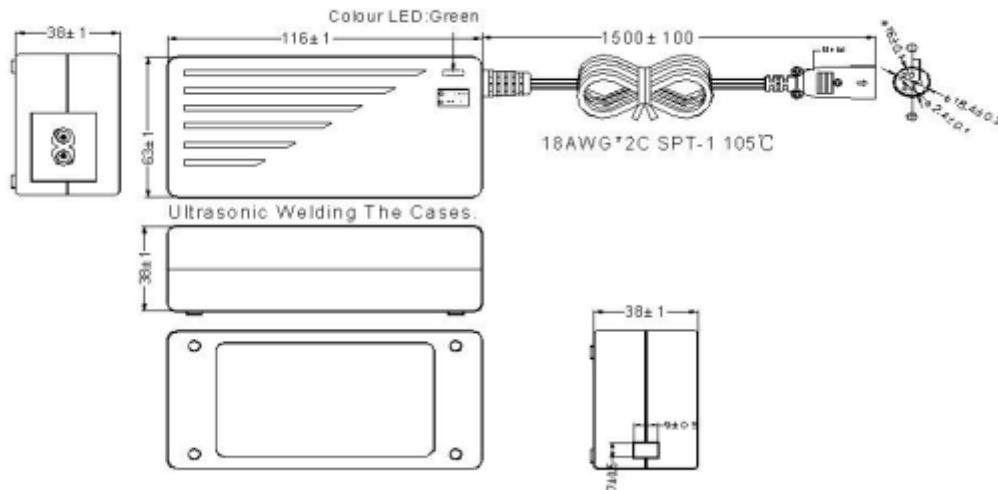

3. Electrical performance

3.1 Input voltage and frequency

Test items	Minimum value	Average value	Max
Input voltage	90Vac	100~240Vac	264Vac
Input frequency	47Hz	50/60Hz	63Hz

3.2 Input maximum current

Input average voltage , Input maximum current: 1.5A ◦

3.3 Maximum inrush current

Input average voltage , output maximum load (cold start 25 °C) condition ,

Maximum inrush current: 70A

3.4 No-load power consumption / Full load efficiency

Input 115Vac/230Vac time , no-load power consumption $\leq 0.5W$: full load efficiency $\geq 85\%$

3.5 Output characteristics (Input voltage / Input frequency : 100~240Vac 50/60Hz)

Test items	Output voltage	Output current	Indicator status
No-load voltage	27.0~27.8V	0mA	Steady green
Load current	24V	1.85~2.15A	Steady Red
Maximum charging voltage	29.0~29.8V	600mA	Steady Red
Turn lamp current	/	400 600mA	Red to green

3.6 Protective function

3.6.1 Overvoltage protection

3.6.2 Short circuit protection

4. Surroundings

4.1 Temperature

4.1.1 Storage temperature : -10~+70 °C

4.1.2 Operating temperature : 0~+40 °C

4.2 Relative humidity

4.2.1 Storage humidity: 5%~95%RH

WARRANTY

■ WARRANTY

There is a comprehensive twelve-month warranty from the date on which your new WT-T4QP2 scooter is delivered. The warranty covers the scooter for repairs or replacement during this period. For more detail, please see the Warranty Conditions below.

Warranty Conditions:

1. Any work or replacement part installation must be carried out by an authorized WU'S TECH dealer / service agent.
2. To apply the warranty should your scooter require attention please contact the designated service agent listed below.
3. Should any part of the scooter require repair or full or part replacement, as a result of a manufacturing or material defect within warranty period, the work will be carried out free of charge. Warranty period:
 - a)Frame : 3 Years limited warranty
 - b)Electronic parts : 24 months limited warrantyNote: The warranty is not transferable
4. Any repaired or replaced parts will be covered by this warranty for the balance of the warranty period on the scooter.
5. Parts replaced after the original warranty has expired will be covered by a three months warranty.
6. Consumable items supplied will not generally be covered during the normal warranty period unless such items require repair or replacement clearly as a direct result of a manufacturing or material defect.
Such items include (among others): upholstery, tires and batteries.
7. The above warranty conditions apply to brand new scooters purchased at the full retail price. If you are unsure whether your scooter is covered, check with the service agent.
8. Under normal circumstances, no responsibility will be accepted where the scooter has failed as a direct result of:
 - a) The scooter part not having been maintained in accordance with the manufacturer's recommendations.
 - b) Failure to use the manufacturer's specified parts
 - c) The scooter or part having been damaged due to neglect, accident or improper use
 - d) The scooter or part having been altered from the manufacturer's specifications or repairs having been attempted before the service agent is notified

Please note your local service agent's contact details in the box below. In the event of your scooter requiring attention, contact them and give all relevant details so they can act quickly.

The manufacturer reserves the right to alter without notices any weights, measurements or other technical data shown in this manual. All figures, measurements and capacities shown in this manual are approximate and do not constitute specifications.

WU'S TECH authorized Service Agent

Name
Address
Tel
Postcode

WARRANTY

■ VIN (SCOOTER INDIFICATION NUMBER)

To ensure the correct after-sale service and warranty service support, please write down the scooter identification number that is stuck on the back side of the frame.

Model	GYPSY TA (for transaxle)
Chassis NO.	
Motor serial #	

Warranty Application Form

Name			
Tel no.			
Address			
Model	GYPSY TA (for transaxle)		
Scooter Data	Scooter Chassis No:		
	Motor Serial No:		
Date of Purchase	Year	Month	Day
Agent Signature			



Wu's Tech Co. Ltd.

3 Fl. No.112 Sec. 2, Chung-Shan N. Rd.,
Taipei, Taiwan, R.O.C.
Tel:+886 2 2541 3253
Fax:+886 2 2536 7575



EV Rider, LLC
6410 Arc Way
Fort Myers, FL 33966
Tel: (239) 278-5054
Fax: (239) 278-1431
service@evrider.com
sales@evrider.com