

Celebrating over 100 years of service, Est. 1911



Fire  End

2023 BROCHURE

STRUCTURAL FIREFIGHTING

LION's "Not In Our House Campaign".....	4-5
LION's Red Zone Contaminant Care.....	6-7
LION TotalCare.....	8-9
Why Isodri?.....	10-11
Custom Turnout Gear.....	12-18
LION Express In-Stock Turn Out Program...	19-21
Suspenders.....	22
Personal Rescue Systems & Rope Bags.....	23-25
Laundry Equipment & Detergent.....	26
Groves Ready Rack.....	27
Ram Air Gear Dryer.....	28-29
Gloves/Hoods.....	30-33
Hoods.....	34
Gearbags.....	35
Helmets/Helmet Fronts.....	36-37
Helmet Accessories.....	38
Goggles/Eye Protection.....	39
Boots & Boot Accessories.....	40-45
Boston Leather & Grime Boss.....	46
LION Training Prop Introduction.....	47

SPECIALTY GEAR & ACCESSORIES

LION Rescuewear.....	48-50
CrewBoss Wildland Protective Clothing.....	51
Gerber Rescuewear.....	52
Hi-Visibility Vests.....	53
Hi-Visibility Jackets & Pants.....	54-58
Stationwear.....	59-61
Fire Police Accessories.....	62-63
Ice Rescue.....	64
Rock-N-Rescue Equipment.....	65

ADAPTERS & FITTINGS

Threaded Adapters.....	66-68
Storz Adapters.....	69-70
Caps.....	70
Plugs & Mounting Plates.....	71
Elbows.....	72
Strainers.....	73

VALVES

Intake Valves.....	74
LDH Appliances.....	75-77
Wyes, Siamese & Hydrants.....	78-79

HOSE & HOSE ACCESSORIES

Double Jacket Hose.....	80
Forestry Hose.....	80
Rubber Covered Hose.....	81
Large Diameter Hose.....	81
PVC Suction Hose.....	82
Hose Accessories.....	83

NOZZLES & MONITORS

Akron Nozzles.....	84-88
Elkhart Nozzles.....	89
Akron Monitors.....	90-91
Elkhart Monitors.....	92-93

FOAM EQUIPMENT

Elkhart Foam Equipment.....	94
Akron Foam Equipment.....	95

WATER SUPPLY

Fol-da-tank Water Tanks.....	96
Dry Hydrants.....	97
CET Fire Pumps.....	98
Fire Extinguishers.....	99

VENTILATION

Battery Powered Ventilators.....	100
Electric Ventilators.....	101
Gas Ventilators.....	102
Super Vac Accessories.....	103-104
Saws.....	105

TOOLS

Kochek Wrenches & Holders.....	106
Firehooks Tools.....	107-111
Flamefighter Tools.....	112

LIGHTING

Helmet Lights.....	113
Personal Lights.....	114
Portable Box Lights.....	115
Scene Lighting.....	116-118

HAZ MAT

Hazardous Materials.....	119
Gas Detecting & Monitoring.....	120-121

WILDLAND FIREFIGHTING

Wildland Hand Pumps.....	122
Wildland Tools.....	123

MISCELLANEOUS

RIT Equipment.....	124
Junkin Stretchers.....	125
Turtle Plastics.....	126
Sava Air Bags.....	127
Specialty Items.....	128
Ladders.....	129
Our Sales Team.....	130

CONTACT US

Fire-End & Croker Corporation
7 Westchester Plaza
Elmsford, NY 10523-1678 USA

Phone: 800-759-FIRE (USA Only)
914-592-3640

EMAIL: INFO@FIRE-END.COM

Order online on our website:
<http://www.fire-end.com>

"I have no ambition in this world but one, and that is to be a firefighter. The position may, in the eyes of some, appear to be a lowly one; but we who know the work which the firefighter has to do believe that his is a noble calling. There is an adage which says that, "Nothing can be destroyed except by fire." We strive to preserve from destruction the wealth of the world which is the product of the industry of men, necessary for the comfort of both the rich and the poor. We are defenders from fires of the art which has beautified the world, the product of the genius of men and the means of refinement of mankind. But, above all; our proudest endeavor is to save lives of men - the work of God Himself. Under the impulse of such thoughts, the nobility of the occupation thrills us and stimulates us to deeds of daring, even at the supreme sacrifice. Such considerations may not strike the average mind, but they are sufficient to fill to the limit our ambition in life and to make us serve the general purpose of human society."

-- Chief Edward F. Croker, FDNY, circa 1910

"Firemen are going to get killed. When they join the department they face that fact. When a man becomes a fireman his greatest act of bravery has been accomplished. What he does after that is all in the line of work. They were not thinking of getting killed when they went where death lurked. They went there to put the fire out, and got killed. Firefighters do not regard themselves as heroes because they do what the business requires."

-- Chief Edward F. Croker, FDNY, speaking upon the death of a deputy chief and four firefighters in February of 1908

CELEBRATING OVER 100 YEARS OF FAITHFUL SERVICE 1911-2022

We wish to thank our loyal customers who have allowed us to serve them for the past 100+ years. It is our company goal to be your number one supplier for the next 100 years... and longer.

Your past and continued business is greatly appreciated.

Don't forget to check out our amazing website - It keeps growing! You won't be disappointed!

www.fire-end.com



a member of Morris Group International

LION
ready for action

WE'VE GOT YOUR BACK, FIREFIGHTERS.

LION's Game-Changing V-Force® Bunker Gear

LION is the proud maker of custom V-Force® bunker gear for the Fire Department of New York (FDNY) as well as many other major metro and volunteer fire departments throughout the U.S. ... and beyond.

Ask us about the FDNY gear specs and request a custom version to fit your department's specific needs.

JOHN O'BRIEN Long Island Sales Representative 516.542.1227	DAN MURRAY Metro Area Sales Manager 914.438.2193	TOM PAULOT Central New York Sales Manager 315.404.1875
---	---	---

Fire End
1.800.759.FIRE | www.fire-end.com

HIGH-PERFORMANCE GEAR COMBINING SPORTS & MILITARY TECHNOLOGY **V-FORCE®**

HIGHLIGHTED ITEMS FOR 2022

LION Training Props
Page 46



LION Victory Glove
Page 30



LION Particulate Hoods
Page 34



LION Red Zone™ Gear
Page 6-7



Streamlight Stinger® 2020
Page 114



LION by Thorogood Boots
Page 40-41



Game Sportswear Jackets
Page 58-59



Fire Wash™ Liquid
Page 26



SuperVac V18 Valor Series Battery Fans
Page 100



The end-all in fire safety®



STOP CANCER AT THE DOOR:
Key steps you should take BEFORE leaving the fire ground!

Decrease contaminants by

85%

WHEN YOU PERFORM A WET-SOAP DECON²

SAFELY REMOVE YOUR GEAR



Ask a fellow firefighter who is wearing latex gloves to take off your PPE gloves. Then, put on **clean latex gloves** before handling your gear.²



Pull your hood over your head while your SCBA is still on instead of pulling it down to rest on your neck.

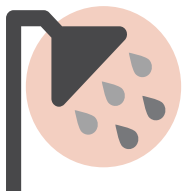

Shower within an hour!
 Wipes are effective, but they don't replace a shower. Start your shower with cold water, then switch to **very hot water**.⁴



WIPE THE SOOT

FROM YOUR BODY.

In this order:²

- 1 **EYES**
- 2 **FACE**
- 3 **NOSE** (Inside first, then blow your nose)
- 4 **EARS** (Inside first, then behind)
- 5 **NECK** (Includes neck and beneath collar)
- 6 **ARMS**
- 7 **HANDS** (Between fingers and under nails)
- 8 **HAIR/TOP OF HEAD**
- 9 **UNDERARMS**
- 10 **TORSO/BACK**

SOURCES:
 1. Contamination of firefighter personal protective equipment and skin and the effectiveness of decontamination procedures. *Journal of Occupational and Environmental Hygiene*, 2017
 2. Using Gloves to Doff Firefighter Gear: Overkill or a Necessary SOP? *Fire Chief*, March 21, 2018
 3. Post-Fire Decontamination Process Using Action Wipes. *Action Wipes*, May 26, 2015
 4. Reducing the Post-Fire Threat of Cancer. *Fire Engineering*, June 21, 2016

NOTE: Your hood should only rest on your neck if it's CLEAN.

ABOUT NOT IN OUR HOUSE: The NOT IN OUR HOUSE cancer awareness initiative is LION's commitment to keeping firefighters and their families safe from fire service-related cancer.

Learn more at notinourhouse.com.

4/18





WE'VE JUST TAKEN PPE CLEANING TO A WHOLE NEW LEVEL.

Carbon Dioxide (CO₂) Contaminant Cleaning Technology
Exclusively Available Through LION TotalCare®

REDZONESM
CO₂ CLEAN

powered by



CONTAMINANT CONTROL

YOU'RE NOW ENTERING THE

RED ZONE™

Contaminant Control Package

When the tones drop and you arrive on the scene of a fire, your turnout gear and hood are immediately exposed to a number of toxic chemicals – exposure that can result in serious health problems. That includes cancer, which is currently the leading cause of U.S. firefighter deaths. With that fact in mind, LION has developed **RedZone™**, our exclusive contaminant control package.

RedZone features five particulate-blocking zones designed to help reduce your exposure to the dangers lurking in fireground smoke:

ZONE 1:

PARTICULATE-BLOCKING HOOD

A breathable, ultra-soft hood with **StedAir® PREVENT** protects the head and neck from particulates, while also providing excellent mobility and unrestricted hearing during firefighting activities.

ZONE 2:

ARM GUARD

Elasticized wrist shields and enhanced **IsoDri®** knit wristlets with **Nomex® Nano Flex** help block particulates at the coat-to-glove interface.

ZONE 3:

CORE GUARD

A **Nomex® Nano** multi-layered composite with an elasticized band helps reduce particulate ingress at the coat-to-pant interface.

ZONE 4:

CLOSURE GUARD

Engages with just one zip. No extra steps to don the gear. Red hook and loop indicates when turnout coat is properly closed.

ZONE 5:

LEG GUARD

Together, the elasticized ankle shield and **Nomex® Nano Flex** calf protector help block particulate exposure at the pant-to-boot interface.



featuring

DuPont™
Nomex Nano

DuPont™
Nomex Nano Flex

StedAIR®
PREVENT

CONTAMINANT CONTROL



Particulate-Resistant Hood

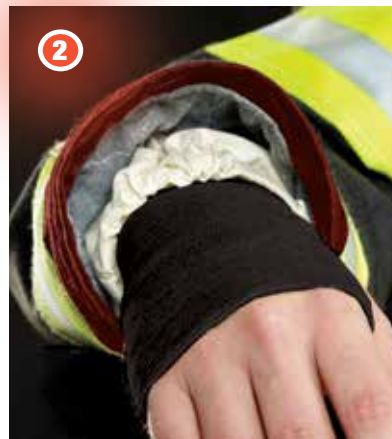

Arm Guard



Closure Guard



Leg Guard (Interior Detail)

To learn more about LION TotalCare PPE maintenance services and state-of-the-art fire training products, visit lionprotects.com



QUESTIONS & PRICING

Contact Fire-End at 800.759.3473 or email us at info@fire-end.com.

LION TOTALCARE®

KEEPING YOU SAFER, LONGER

Soiled gear can pose a health risk to firefighters. Smoke deposits and condensed residue can become trapped in fibers and remain there until cleaned, leaving you at risk to secondary exposure to cancer-causing chemicals and gear that may not provide you with protection when you need it most. Detecting damage on your gear early via regular inspections can help prevent ongoing degradation, as well as identify signs of failure before they become a safety issue or lead to irreversible damage.

Help enhance firefighter safety and save your organization money by extending the life of your PPE through regular cleaning, inspection and repair with LION TotalCare.

When you use LION TotalCare, you are choosing to partner with a company that has over 20 years of experience in helping to keep you safe. As a Verified Independent Service Provider for all components of turnout gear, all of our repairs are NFPA-certified.

PPE CLEANING

We offer Advanced Cleaning, Decontamination and Biohazard Disinfection, all of which are performed by trained and experienced professionals. Turnout gear takes serious abuse – and that requires extra work on your part. Even the best-quality turnout can see a lifetime of as little as three years when it is not cleaned and well-maintained – but it doesn't have to be that way. Consistent cleaning and maintenance of your gear can help it reach the 10-year maximum lifespan under NFPA 1851, saving you money on replacements and giving you peace of mind knowing that your gear is ready for that next call.

PPE INSPECTION

TotalCare goes beyond the obvious with advanced inspection services that go from your shell to your moisture barrier or liner system. For gear older than three years, we do an annual liner inspection, complete with hydrostatic testing and evaluation of hidden seams. Charring or tearing on an outer shell may be easy to spot, but not on your liner system or leaks in your moisture barrier. TotalCare's advanced inspection goes deeper to uncover all possible issues and help keep you safe.

PPE REPAIR

MORE COST EFFECTIVE THAN REPLACEMENT

Worn or damaged gear is often repairable and a more cost-effective solution than replacement. LION TotalCare® will repair gear without compromising its original construction to maximize the gear's performance. We can also repair gear as part of its maintenance, fixing small issues before they become big problems.



CLEANER GEAR IS SAFER GEAR.

An example of a turnout coat inspected, cleaned and repaired by **LION TotalCare®**.



Typical TotalCare cleaning and repair services include **Inspection, Disinfection, Washing, Trim Replacement and Hole/Rip Repair.**

isodri®

Game-Changing Turnout
Gear Moisture Management
Technology from LION®



What's inside your turnout gear?

Firefighters know they face danger every time they step foot off the engine at a fire site. You have to be at the top of your game, and make quick decisions to save lives and keep yourself and your fellow firefighters safe. The last things you need to worry about are staying dry and comfortable.

LION's innovative isodri® technology was developed to help keep you more dry and comfortable so that you can focus on the job at hand.

Less water on the inside means your gear will be lighter.

You are already shouldering a lot of weight with your SCBA and carrying a fully charged hose through a fire site. You do not need your gear to take on additional heft to bog you down while working. Only isodri can keep your gear as light as possible, helping you focus on the task at hand.

A traditional liner system and LION's isodri liner system were tested. Both

weighed the same amount dry. Once both liner systems were immersed in water for the same period of time, they were weighed again. The traditional gear weighed five times as much as LION's turnout gear featuring the isodri system. That's a lot of extra weight to carry around, further contributing to heat stress.

Gear dries faster between runs as it will absorb less water.

How many times have you received another call just hours after you returned to the firehouse from a previous run? No one likes to put on wet and clammy gear and head out on a run.

Firefighters have reported that gear with the isodri system dries and is comfortable to wear in **less than 30 minutes** after doffing. That quick turnaround means you're comfortable and ready to go no matter how quickly that next fire alarm goes off.



isodri®

Game-Changing Turnout Gear
Moisture Management Technology
from LION®



The more air insulation in your liner system, the less likely it is you'll get injured.

Did you know that water transfers heat to your skin 21 times faster than air? That's why drier gear is safer for you. Only isodri manages moisture in the thermal barrier of your turnout gear.

The thermal liner works like insulation in a house, trapping air inside millions of tiny pockets. The trapped air creates a barrier to heat flow. If the air pockets are compressed or filled with moisture, the thermal liner's ability to block heat is compromised. More air inside your gear keeps you drier, and safer.

HOW ISODRI® WORKS

isodri® is more than just an outer shell that resists water penetration and absorption. It is a complete system of components (outer shell, moisture barrier, thermal barrier and wristlets) that works together to reduce the water in your turnout gear and the dangers that water presents.

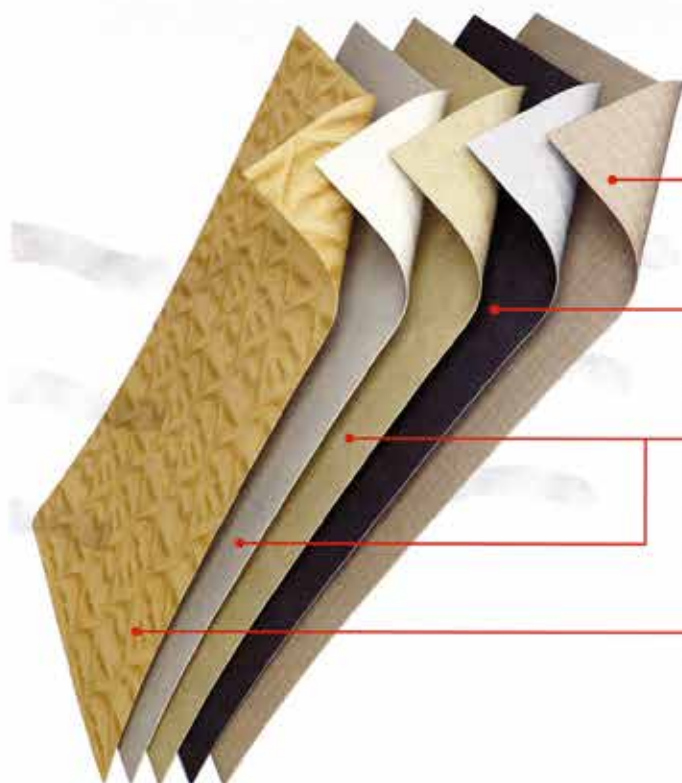

Outer shell is treated with Teflon® F-PPE to reduce moisture intake from outside sources such as hose water and rain.

W.L. Gore CROSSTECH® Black, CROSSTECH® 3-Layer or RT7100™ moisture barrier allows body heat, in the form of vapor, to escape, but keeps liquid out.

Thermal barrier is treated with Teflon® F to shed moisture generated by the body and maintain high thermal performance. AraFlo® promotes air permeability to allow vapor released by the body to be more easily transported away from the skin.

Facecloth wicks perspiration away from the body.



Combining Combat & Sports Technology

V-Force® Turnout Gear



High-performance V-Force turnouts that feature an innovative cut-in-motion V-Fit® Design for ergonomic gear that moves the way your body does, while providing unparalleled protection.

FEATURES & BENEFITS INCLUDE:

- Patented IsoDri® Moisture Management System manages gear moisture by blocking water, wicking perspiration and resisting water retention. This keeps working weight low and helps guard against steam-related injuries.
- Raglan sleeve removes top-of-the shoulder pressure point Shaped like your arm to promote free, unrestricted movement and reduce hem rise.
- V-Fit® elbows, legs and knees provide countoured legs, arms, cutouts, shaped elbow and knee pattern pieces allow natural arm and knee movement without restrictions or tugging.
- Polymer-coated aramid (PCA) V-Notch™ elbow and knee reinforcements to protect against high-abrasion wear and help keep heat and moisture out.
- Pants are available in five different styles to meet individual on-the-job safety and comfort needs.
- Radial inseam and banded crotch reduce tension and increase turnout pants comfort and mobility.
- Patented Ventilated Trim™ provides a conduit for the release of vapor and guards against the potential hazards of trapped moisture.
- Distinctive Viz-A-V™ reflective trim pattern accentuates the V-Force coat's fitted sides, while maximizing visibility.



Combining Combat & Sports Technology

V-Force® Turnout Gear



High-performance turnouts that feature an innovative cut-in-motion V-Fit® Design for ergonomic gear that moves the way your body does, while providing unparalleled protection.

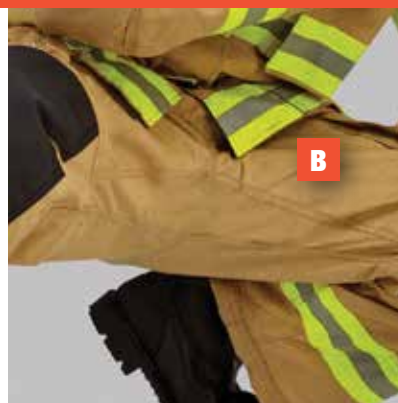

KEY V-FORCE DESIGN HIGHLIGHTS

A. Viz-a-V™ Reflective Trim Pattern

B. Radial Inseam

C. V-Fit Elbow with V-Notch™ Polymer-Coated Aramid (PCA) Reinforcement

D. V-Fit Knee with V-Notch PCA Reinforcement

E. Extended Cuff with IsoDri® Knit Over-The-Hand Wristlets

F. Optional Bi-Swing Back

G. V-Fit Cut-In-Motion Contoured Sides



To learn more about V-Force turnout gear and other LION products, contact your LION sales representative or visit www.lionprotects.com/v-force.

04/21

Freedom® Design for Mobility & Comfort

Super-Deluxe™ Turnout Gear



With its fully featured bi-swing back turnout coat and low-rise waist pants, LION's Super-Deluxe is built to fit the way you work — providing outstanding mobility and comfort.

FEATURES & BENEFITS INCLUDE:

- Ergonomically shaping to improve comfort and interface with other PPE elements
- Bi-swing back with inverted pleats in all layers of the system expand as the arms move forward, resulting in no tugging or binding at the shoulder
- Underarm bellows reduce the hem rise and sleeve travel
- Freedom Elbow enables the arm to bend freely while keeping the wrists protected by reducing sleeve travel
- Comfort collar and optional throat tab deliver continuous thermal and moisture protection while providing exceptional interface to SCBA mask
- Low-rise pants complement the natural contours of the body for increased comfort
- Radial inseam and banded crotch reduce tension and add comfort to turnout gear
- Freedom Knee provides gusset that the knee can fall into when crawling, climbing, bending and kneeling
- Knees include layer of Lite-N-Dri™ for added thermal protection and comfort
- Available in a wide range of custom sizes to fit your needs



Super-Deluxe™ Turnout Gear

Freedom® Design
For Mobility & Comfort



With its fully featured bi-swing back turnout coat and low-rise waist pants LION's Super-Deluxe is built to fit the way you work— providing outstanding mobility and comfort.

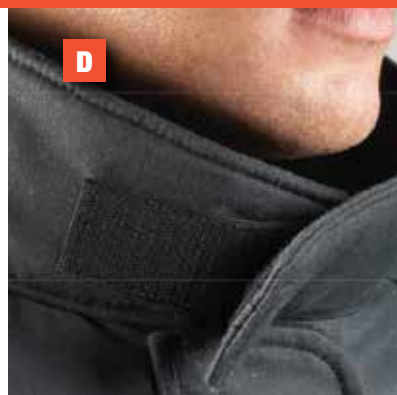

KEY FREEDOM® DESIGN HIGHLIGHTS

A.
Bi-Swing
Back Design
with Bellows
Underarm
Construction

B.
Leather
Reinforced
Kick Shields

C.
Storm Flap
Closure with
Hook & Loop
and Thermoplastic
Zipper Coat
Closure

D.
Overlapping
Comfort Collar

E.
8" Over-The-Hand
Wristlets

F.
Leather
Reinforcements
on Knees,
Cuffs, Shoulders,
and Elbows

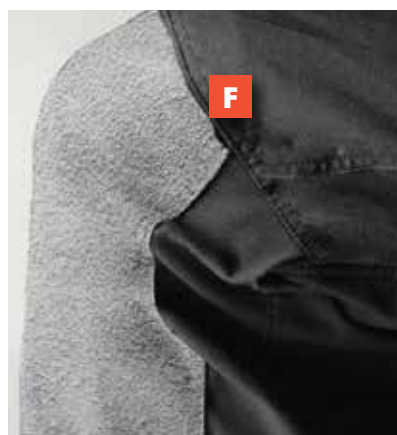
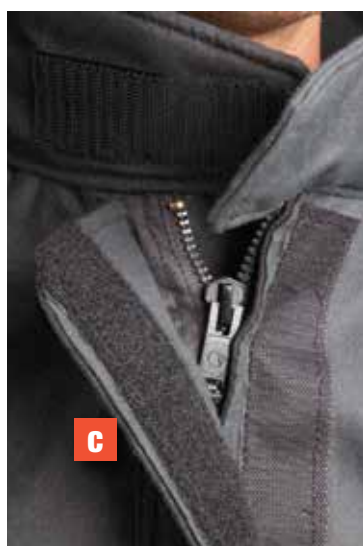
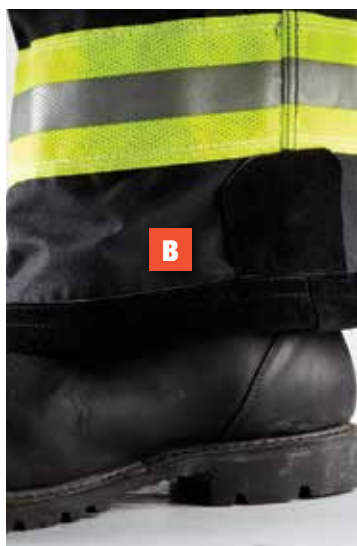

To learn more about the LION Super-Deluxe turnout gear and other LION products, contact your LION sales representative or visit www.lionprotects.com/turnouts-super-deluxe

LION's Most Economical Custom Turnout Solution

Liberty™ Coat & Pants

A lightweight coat with bi-swing back for exceptional forward mobility and high-back pants for reliable thermal protection



LIBERTY COAT FEATURES & BENEFITS

- Designed to enhance upper body maneuverability when performing firefighting activities
- The bi-swing back design has inverted pleats in both the outer shell and thermal barrier
- Pleats expand as your arms move forward (even when wearing an SCBA) reducing tugging, binding and overall stress
- LION's patented Ventilated Trim™
- Bellows underarm construction to prevent hem rise and deliver a superior fit
- 4" Kevlar®/Spandex® wristlets
- A comfortable 3" comfort collar is smooth-fitting at neck
- 3" Storm flap with Velcro® closure and zipper coat closure
- Leather reinforcements on cuffs, shoulders and elbows for added wear life
- Inspection opening to enable a complete liner inspection without opening the hem of the coat liner
- Available in 32" or 35" lengths for males and 29" or 32" lengths for females



Bi-swing back provides optimum comfort and mobility. It expands to reduce binding and promotes free forward movement.



LION®

In addition to the Liberty, LION offers a variety of high-quality custom and stock turnout solutions. visit www.lionprotects.com

LION's Most Economical Custom Turnout Solution

Liberty™ Coat & Pants



A lightweight coat with bi-swing back for exceptional forward mobility and high-back pants for reliable thermal protection

LIBERTY PANTS FEATURES & BENEFITS

- Back panel extends 6" over the traditional ProjectFIRES™ waistline for added thermal protection at a critical interface point.
- Designed with bellows knees that won't bind or pull when you're crawling, climbing, bending or kneeling
- LION's patented Ventilated Trim™
- Water-resistant FR Lite-N-Dri™ closed-cell cushioning placed in the knees to further enhance thermal protection and comfort
- Standard leather with Lite-N-Dri™ cushioning reinforced knees, cuffs and kick shields
- Liner system has an inspection opening to enable a complete liner inspection without opening the hem of the liner



Back panel extends 6" over traditional waistline for added thermal protection.



3M Scotchlite™
Reflective Material

DuPont
Nomex.

DuPont
Kevlar



LION®
ready for action

To learn more about our Liberty custom turnout gear, contact your LION sales representative or visit www.lionprotects.com/turnouts-liberty

6/15



WE'VE GOT YOUR BACK, FIREFIGHTERS.

LION's Game-Changing V-Force® Bunker Gear

LION is the proud maker of custom V-Force® bunker gear for the Fire Department of New York (FDNY) as well as many other major metro and volunteer fire departments throughout the U.S. . . . and beyond.

Ask us about the FDNY gear spec and request a custom version to fit your department's specific needs.

JOHN O'BRIEN
Long Island
Sales Representative
516.542.1227

DAN MURRAY
Metro Area
Sales Manager
914.438.2193

TOM PAVLOT
Central New York
Sales Manager
315.404.1875



1.800.759.FIRE | www.fire-end.com

© 2019 Lion Group, Inc.

HIGH-PERFORMANCE GEAR COMBINING SPORTS & MILITARY TECHNOLOGY

V-FORCE®

LIONExpress™

LION Armor AP™ Coat and Pants

FULL-FEATURE FIREFIGHTER TURNOUTS AT THE READY

Whether you're upgrading your PPE, outfitting firefighter recruits or adding personnel, LIONExpress™ can ship your firefighter turnout order within a week. Each LIONExpress™ turnout has Freedom® Design — exceptional design features that provide you with the mobility, comfort and thermal protection you need.

Available in Gold and Khaki

Certified to NFPA 1971 current edition



LION Gold Armor AP™
Coat and Pants
(See Page 20)



LION Khaki Armor AP™
Coat and Pants
(See Page 21)

LIONEXPRESS GARMENT SPECS		
FEATURE	KHAKI ARMOR AP	GOLD ARMOR AP
Outer Shell	6.5 oz comfort twill weave Nomex®/Kevlar® spun yarn/filament offers great flexibility, durability, and protection	6.5 oz comfort twill weave Nomex®/Kevlar® spun yarn/filament offers great flexibility, durability, and protection
Color	Khaki	Gold
Moisture Barrier	Gore RT7100™ a reliable combination of durability, breathability, thermal and liquid protection	Crosstech® Black long-lasting protection and breathability even after exposure to extreme heat
Thermal Liner	Prism™ Pure Prism face cloth quilted to a Kevlar/ Nomex batt for a good balance of TPP and THL	Glide Ice™ 2L Araflo® Isodri High-lubricity Glide Ice face cloth quilted to two layers of durable water repellent Kevlar/Nomex E-89 spunlace (2.3 and 1.5 Araflo) for lightweight thermal protection and optimal moisture management
Reinforcements	Elbows, shoulder caps, and coat cuffs reinforced with extra layer of Armor AP Knees and pant cuffs reinforced with gold polymer coated aramid	Elbows, shoulder caps, knees, coat and pant cuffs reinforced with gold polymer coated aramid



COATS SIZING CHART: UNISEX		Shaded sizes are made-to-order (75 Day Lead Time)					
Chest Size	32", 34"	36"	38", 40"	42", 44"	46", 48", 50", 52", 54", 56"	58", 60", 62"	
Sleeve Length Regular	32"	33"	34"	35"	36"	36"	
Sleeve Length Long	34"	35"	36"	37"	38"	38"	
PANTS SIZING CHART: UNISEX		Shaded sizes are made-to-order (75 Day Lead Time)					
Waist Size	28"	32", 34", 36", 38", 40", 42", 44", 46", 48"	50", 52", 56", 58"				
Inseam		29" (R) 31" (L)					

Gold Armor AP™ Coat and Pants

Built with isodri® Protective Systems

- 6.5 oz/yd² Armor AP™ outer shell of 65% DuPont™ Kevlar® and 35% DuPont™ Nomex® twill weave with extremely durable FPPE water resistant Teflon® FPPE alloy
- Glide Ice™ face cloth quilted to 2.3 oz/yd² Nomex®/Kevlar® Spunlace Dri and 1.5 oz/yd² AraFlo® Dri for lightweight thermal protection with optimal moisture management
- CROSSTECH® black moisture barrier promotes evaporative cooling of body heat and resists water, blood-borne pathogens and common chemicals
- New York City style 3M™ Ventilated Scotchlite™ Reflective Material triple trim (lime-yellow and silver)

Armor AP™ Coat (32" length)

CCHX-42 (Gold Color)

- 3" contoured comfort collar for comfortable interface with SCBA mask
- LION's exclusive SemperDri™ system in water wells and yoke reduces water absorption to keep your working weight low
- Bi-swing back for exceptional forward mobility
- Freedom® elbow design for natural flexing motion and optimum mobility
- Gold polymer-coated aramid cuff reinforcements and bellow elbow with Lite-N-Dri™ cushioning
- 4" x 6" polymer-coated aramid shoulder caps
- 8" over-the-hand Nomex®/Kevlar® IsoDri® wristlets
- 3.5" x 9" x 2" radio pocket on left chest
- 8" x 8" x 2" semi-bellows pockets, lined all 4 sides with Kevlar® twill
- Thermoplastic zipper coat closure with hook and loop storm flap closure
- Roomy 8.5" x 9" liner pocket
- Drag Rescue Device (DRD) with soft weave Kevlar® webbing for comfort
- Liner inspection system

Armor AP™ Pants

PCHX-42 (Gold Color)

- Low-rise waist complements the natural contours of the body
- Freedom® knee with Lite-N-Dri™ cushioning at the knee between the thermal liner and moisture barrier for natural flexing motion and optimum mobility
- Gold polymer-coated aramid knee with Lite-N-Dri™ cushioning
- Gold polymer-coated aramid cuff and kick shield reinforcements
- Radial inseam band enables free and natural movement
- LION's exclusive SemperDri™ system in lower legs reduces water absorption to keep your working weight low
- Thermoplastic zipper pants closure with hook and loop storm fly closure
- External self-fabric take up straps for custom fit
- 8" x 8" x 2" full bellows pocket on each thigh lined with Kevlar® twill
- EZ H-Back quick-adjust, non-stretch suspender
- Liner inspection system



Certified to NFPA 1971 current edition

Coat Options:

FLS521	1" x 10" Flashlight Strap
MF003	Reverse Snap Hook
MF011	Dee Ring
MT503	1" x 3" Mic Tab

LP1S	4" x 18" One Line Letter Sewn on Letter Patch
LP1V	4" x 18" One Line Letter Patch w/ Velcro
LP34	5" x 18" One Line Hanging Letter Patch on Hem

Letters	One Name Line of 3" Sewn on Letters (up to 12 Letters)
ID	One ID Line of 3" Sewn Letters (ID Lettering, less than 6)
	Must order a patch for all lettering



*NY State Contract pricing available, call for pricing.

Khaki Armor AP™ Coat and Pants

- 6.5 oz/yd² Armor AP™ outer shell of 65% DuPont™ Kevlar® and 35% DuPont™ Nomex® twill weave with extremely durable FPPE water resistant Teflon® FPPE alloy
- Prism Pure 3.6 oz/yd² face cloth quilted to 3.75 oz/yd² virgin 50% para-aramid/50% meta aramid batting
- Gore RT7100™ moisture barrier promotes evaporative cooling of body heat and resists water, blood-borne pathogens and common chemicals
- New York City style 3M™ Ventilated Scotchlite™ Reflective Material triple trim (lime-yellow and silver)

Armor AP™ Coat (32" length) CCAX-80 (Khaki Color)

- Low hem rise for increased mobility
- 3" contoured comfort collar for comfortable interface with SCBA mask
- Freedom® elbow design for natural flexing motion and optimum mobility
- LION's exclusive SemperDri™ system in water wells and yoke reduces water absorption to keep your working weight low
- Elbows, shoulder caps, and cuffs reinforced with self-fabric material
- 8" over-the-hand KEVLAR®/Spandex® wristlets
- 3.5" x 9" x 2" radio pocket on left chest
- 9" x 9" x 2" semi-bellows combination handwarmer pockets with Kevlar® twill backing and Semper Dri™ lining
- Roomy 8.5" x 9" liner pocket
- Thermoplastic zipper coat closure with hook and loop storm flap closure
- Drag Rescue Device (DRD) with soft weave Kevlar® webbing for comfort
- Liner inspection system

Armor AP™ Pants PCAX-80 (Khaki Color)

- Low-rise waist complements the natural contours of the body for increased comfort. Fits and feels more like an every day pair of trousers.
- FR Lite-N-Dri™ cushioning at the knee between thermal and moisture barrier
- Gold polymer-coated aramid reinforcements in knees with FR Lite-N-Dri™ padding
- Gold polymer-coated aramid reinforcements in cuffs and kick shields.
- SemperDri™ system in lower legs reduces water absorption to keep your working weight low
- Thermoplastic zipper fly closure with hook and loop storm fly closure
- External self-fabric take-up straps (2) for custom fit
- 10" x 10" x 2" full bellows pocket on each thigh lined with Kevlar® twill
- 3M™ Scotchlite™ Reflective Material (triple trim, lime-yellow and silver) at lower pants legs
- LION Ventilated Trim™ provides a conduit for the release of vapor and guards against the potential hazards of trapped moisture
- EZ H-Back quick-adjust, non-stretch suspenders
- Liner Inspection System



Certified to NFPA 1971 current edition

Coat Options:

FLS521	1" x 10" Flashlight Strap
MF003	Reverse Snap Hook
MF011	Dee Ring
MT503	1" x 3" Mic Tab

LP1S	4" x 18" One Line Letter Sewn on Letter Patch
LP1V	4" x 18" One Line Letter Patch w/ Velcro
LP34	5" x 18" One Line Hanging Letter Patch on Hem

Letters	One Name Line of 3" Sewn on Letters (up to 12 Letters)
ID	One ID Line of 3" Sewn Letters (ID Lettering, less than 6)
	Must order a patch for all lettering



*NY State Contract pricing available, call for pricing.



**NY State Contract
Pricing Available -
Call for pricing*



EZ Adjust H-Back, Quick Adjust Non-Stretch, Black

For Use with Traditional and Super Turnout Pants

- SB334** 34" (Extra Short) length with wire clips
- SB336** 36" (Short) length with wire clips
- SB342** 42" (Regular) length with wire clips
- SB348** 48" (Long) length with wire clips
- SB354** 54" (Extra Long) length with wire clips

For Use with Liberty™ or Deluxe™ High-Back Turnout Pants

- SB636** 36" (Short) length with wire clips
- SB640** 40" (Regular) length with wire clips
- SB645** 45" (Long) length with wire clips



V-Back™ Quick Adjust, Stretch Padded, Red

For Use with V-Force® Belted Turnout Pants or Any Non High-Back Turnout Pants

- SR836M** 36" (Short) length
- SR842M** 42" (Regular) length
- SR848M** 48" (Long) length

**Above with wire clips in front and back*



EZ H-Back Quick Adjust, Non-Stretch, Black with 3M™ Scotchlite™ Reflective Material (Yellow)

For Use with Traditional and Super Turnout Pants

- SB336T** 36" (Short) length
- SB342T** 42" (Regular) length
- SB348T** 48" (Long) length

**Above with rectangular metal loops and trim.*

**Requires PMO210 snap tabs on pants.*



V-Back™ Quick Adjust, Stretch Padded, Red

For Use with V-Force® High-Back Turnout Pants

- SR836** 36" (Short) length
- SR840** 40" (Regular) length
- SR845** 45" (Long) length

**Above with rectangular metal loops & rear hook & loop fastener panel*

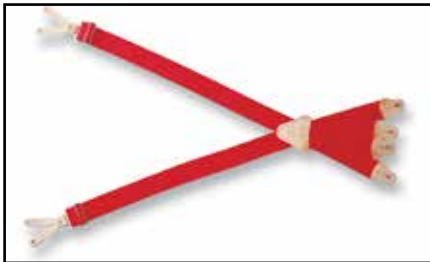

S-T-R-E-T-C-H, Red, Four-Way

- SR143L** 43" (Regular) length
- SR150L** 50" (Long) length

**Above with leather tabs*

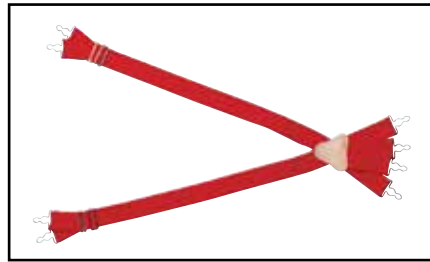

Four-Way, Non-Stretch, Red

- SR242** 42" (Regular) length
- SR248** 48" (Long) length

**Above with wire clips*

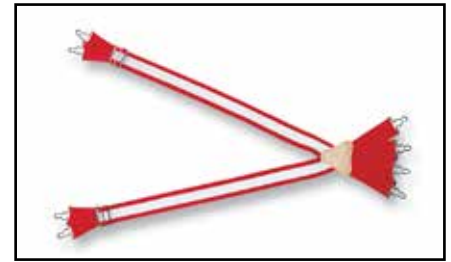

Night Hawk Four-Way, Non-Stretch, Red with 3M™ Scotchlite™ Reflective Material (Silver)

- SR242T** 42" (Regular) length
- SR248T** 48" (Long) length

**Above with wire clips*



*Certified to meet
NFPA 1983*

Personal Rescue System from LION

Easy To Use. Always with you. Never in the way.

The Personal Rescue System from LION integrates all escape components (50-foot escape line, descender, your choice of anchor, a quick link and a tether) and stows them in a cargo pocket on the leg of turnout pants. It can be deployed using any Class II life safety harness or escape belt.

There are two pocket options: horizontal or vertical split cargo pocket. Each keeps the rope from becoming entangled with the other hardware.

The Personal Rescue System is available on most LION turnouts. It can also be retrofitted to any manufacturer's turnout pants and works with the LION Integrated Class II Harness, the LION Escape Belt (see below) or with any manufacturer's Class II harness or escape belt.



The Personal Rescue System integrates all escape components and stows them in a cargo pocket on the leg of turnout pants.

LION INTEGRATED CLASS II HARNESS™ & ESCAPE BELT

LION Integrated Rescue Harness™ - Ready When You Need It

LION's Integrated Class II Harness™ features a new single-point of attachment design for improved functionality and ergonomically positioned leg loops for increased comfort. The harness is built into your turnout pants so it's always available when you need it. The harness is located between the outer shell and liner system. This maintains the integrity of your PPE and protects the harness. The harness is removable for easier care and maintenance.

Made from Kevlar® with a unique design that makes it intuitive — its size responds to the user. It tightens when loaded, yet is relaxed and doesn't interfere with other work situations. The LION Integrated Class II Rescue Harness™ is designated as a NFPA 1983, Class II Life Safety Harness. It is to be used for emergency escape with up to two-person load/capacity. It also meets all the requirements of NFPA 1971, so the harness retains its integrity when exposed to heat. A LION Integrated Class II A-Frame Rescue Harness (with certified ladder teather) is also available.



A-Frame Integrated Class II Rescue Harness

LION Escape Belt

The LION Escape Belt is an emergency self-rescue device that fastens at the waist outside of your turnout pants. The belt is positioned through belt loops on the pants and fastens with a hook and ring closure. When the escape rope is attached to the belt, it engages in the proper position.

The escape belt is made from two-inch Kevlar® webbing and is certified to meet NFPA 1983. It is certified for use up to 300 pounds. When the belt is combined with a rope, descender and carabiner, it can be used as an escape system.



***Call us today, for details and pricing!**

Rock-N-Rescue Escape Systems

RNR, W/F4 & LIGHTNING GT HOOK – Personal Escape Rope

RES005

RNR, W/F4 & LIGHTNING GT HOOK – Safe Tech Rope

RES011

RNR, W/F4 & LIGHTNING GT HOOK – Fire Tech 2 Rope

RES017

The latest in personal escape systems. This kit includes the innovative F4 personal escape device (red), 50' of Escape Tech, Personal Escape (nylon), or Fire Tech rope, an auto-locking carabiner and the new Lightning GT Hook all packed into a strong and durable bag. Made in USA. Weight 3.3 lbs.



Petzl Exo AP Hook w/ Carry Bag

D30AB015

Features:

- Multi-purpose anchor hook, usable in locations where the possibility of finding an anchor point is uncertain. Can be used in two ways: around a structure, fixed with a locking hitch or on a window sill, as a last resort
- Self-braking system with anti-panic function for: rapid horizontal movement, going out a window, controlling and stopping a descent: if the user pulls too hard on the handle, the anti-panic function brakes and stops the descent automatically, and limiting the force transmitted to the user in case of a fall.
- Aramid fiber static rope, 50 foot (15 m) length and 7.5 mm diameter, resists abrasion and high temperatures.
- Am'D connector with CAPTIV positioning bar, to help keep the connector correctly positioned and integrated with the device.
- Fire-resistant carry bag for attaching the system directly to the harness



D30AB015

R&B Rope Bags

236RD Red Large

236OR Orange Large

The largest of our rope bags. Features a 2" web handle and #5 grommet in the bottom of the bag. This bag will hold 500'-600' of 5/8" rope. 15"L x 17"Dia., 51" Circumference

235RD Red Medium

235OR Orange Medium

This bag holds the rope that most rescue squads are required to carry. Features #5 grommet in the bottom of the bag, 1 1/2" web handle. This bag will hold 250'-300' of 1/2" rope or 200'-250' of 5/8" rope, 14"L x 12" Dia., 37" Circumference

234RD Red Small

234OR Orange Small

The smallest of our rope bags. Features 1" web handle and #5 grommet in the bottom of the bag. This bag will hold 150'-200' of 3/8" rope or 80'-100' of 1/2" rope, 13"L x 8" Dia, 22" Circumference



546NYC Gemtor Class II Fire Service Harness

Front Leg Strap Adjusters and Single Point Waist Adjustment
Includes Escape System Attachment D-Ring

546NYCL - Left Side Opening (Front Leg Strap Adjusters)

546NYCR - Right Side Opening (Front Leg Strap Adjusters)

NEW



546NYC

541NYC Gemtor Class II Fire Service Harness

This is the FDNY Personal Harness!

541NYCL - Left Side Opening

541NYCR - Right Side Opening

Features & Benefits of 546NYC & 541NYC

- Fast and Easy Donning
- Can be attached to bunker pants using loops available from most turn-out gear manufacturers.
- Color coded design for easy donning
- Fixed length front, Handle always the same length regardless of adjustment.
- 3-Stage locking Pompier hook with 2" side opening gate available in Aluminum (NFPA General Use Carabiner classified by UL)
- Extremely lightweight, weighs only 2.8 lbs! (Aluminum hook).
- Forged alloy steel escape system attachment D-ring.
- Sturdy, lightweight nylon webbing 1 3/4" wide stitched with high tenacity nylon thread.
- Easy waist belt operation, just engage steel snaphook and D-ring.
- Available with right side or left side (FDNY style) opening
- Unique design lowers the body's center of gravity and helps reduce the possibility of toppling.
- Can be attached to bunker pants.
- Pompier hook stores at center front position.

541NYC/546NYC (Regular Fits 36"-50")

541NYC/546NYC (Small Fits 30"-44")

541NYC/546NYC (XL Fits 44"-56")

UL Classified to NFPA 1983-2012 edition



541NYC

UL Classified to NFPA 1983-2012 edition

**Manufacturer's Advertised Prices shown - please call for special pricing*

544FR Gemtor Class II Kevlar Fire Service Harness

Flame Resistant, Includes Escape System Attachment D-Ring

544FR - Class II Harness, Kevlar, Right side opening

- Can be worn externally with loops on outside of bunker pants.
- Can be used with an Escape System (includes escape system sliding D-ring) Made of 1 3/4" wide Kevlar webbing and stitched with high strength Kevlar thread.
- Double layer A-frame and heavy-duty hardware for extreme durability.
- Simple waist connection.
- Adjustable leg straps.
- Standard right side opening. Available with left side opening.

NEW



544FR

Note: Harnesses are adjustable within a range but are individually sized. Specify your bunker pant waist size when ordering for internal use. When ordering for external use, provide the measurement of the waistband over the outside of the bunker pants.

**Manufacturer's Advertised Prices shown - please call for special pricing*

UL Classified to NFPA 1983-2012 edition

PPE Laundry Equipment ON-PREMISES WASHER-EXTRACTORS

Engineered to deliver an optimal user experience – intuitively designed software allowing operators to navigate and manage system controls, and program cycle settings – with simplicity, efficiency, and confidence.

Features & Benefits

- Fully programmable by keyboard or laptop
- Can hold many wash programs or formulas
- Chemical connections and signal for soap pump
- Soft or rigid mount available
- Robust construction to handle tough loads and extraction forces

**Call For Pricing & Information*



Electrolux



Maytag

Ready Rack Extractor Model EW30



Features & Benefits

- Easy to use, preprogrammed wash cycles
- Follows NFPA 1851 guidelines for proper PPE maintenance
- Standard power hookup (120v/60Hz - Recommended Breaker - 20amp)
- Utilizes standard plumbing hookups
- Soft mount design, easy install
- Connections available for an optional automatic soap injector
- Front load design
- 30lb. drum holds three to four sets of gear per load
- Dimensions: 29.0" L x 32.0" D x 40.8" H
- Weight: 221 lbs

**Call For Pricing & Information*



EW30

LION TotalCare Station Care 1851 Turnout Cleaner Advanced Gear Cleaner You Can Trust

LION TotalCare 1851 is specially formulated by LION TotalCare, and made just for PPE. It is used consistently around the country at each LION TotalCare facility, for a clean you can trust no matter where you are.

Features & Benefits

- Removes the harmful contaminants while maintaining your gear's integrity
- Meets requirements of NFPA 1851 Section, Care and Maintenance Standard
- Leaves no residue that is common with other cleaning products
- Cost effective solution for cleaning your turnout gear

SCC2 2-Gallon Case — approx. 125 garments

SCC5 5-Gallon Pail — approx. 310 garments



Fire Wash™ Liquid

Fire Wash™ safely and effectively removes toxins, hydrocarbons and other contaminants from your personal protective ensembles.

Fire Wash is the only Bunker Gear detergent that has been 3rd Party tested and proven to effectively and safely clean Bunker Gear. 100% NFPA 1851 Compliant

FW203-C Case of (4) 1-Gallon Jugs

FW203-B 5-Gallon Pail



Also available in 55 Gallon Drums - Please call for charge

The Original TURNOUT GEAR STORAGE SYSTEM!



Freestanding Red Rack™



Wall Mounted Red Rack™



Mobile Hose Cart



Mobile Red Rack™



Dry & Store Hose Rack

Mobile Worktable



Air Dry Laundry Rack

We carry a full line of Ready Rack products - Call us for info and pricing

Turnout Gear Dryers 4, 6 and 8 - Place Bunker Gear Dryers

TARGET HARD-TO-DRY AREAS

Ram Air's patented design uses powerful fans that push air through gear from the inside out—effectively drying the hard to reach areas and vapor barriers in gear that are prone to mold and mildew if not dried properly. The unique design of our gear dryers limits air loss and prevents air flow from following the path of least resistance. The result? Faster, more efficient drying and an increased ability to dry more suits in the same amount of time.

FLEXIBILITY FOR ALL GEAR COMPONENTS

We know what it is like to work in wet boots and gloves. That is why Ram Air's 6-MU Gear Dryer comes fully loaded with 18 component ports for drying all accessories including helmets, gloves, boots, face masks and SCBAs. Keeping you dry and comfortable is our job.

FEATURE STRUCTURALLY SUPERIOR CONSTRUCTION

We strive to deliver products that set quality standards beyond any other competitor's products. Heavy-duty casters provide mobility for the unit; top-quality steel construction of the frame and air passages ensure that Ram Air Gear Dryers are built to last; and a LED timer with automatic shut-off provides easy, efficient drying. We design our gear dryers to be the most structurally superior gear dryers available and stand by them with a full two-year guarantee!

TOUCH SCREEN CONTROL FOR DRYING WITH AMBIENT OR HEATED AIR

A touch screen control on gear dryers gives users immediate visual access to the drying status/dry time remaining and personalized control of dry time/temperature through customized settings. The control features a simple user interface with clearly defined icons. Users can select one of the five drying time presets including a continuous drying option, or they can choose the custom timer option—a feature that allows users to select a custom dry time based on their department's unique drying needs. When the dryer is in use, the screen clear displays the drying status using a series of easy-to-understand icons and a timer countdown keeps users abreast of dry time remaining—even at a glance. The touch screen is extremely durable with a smooth flat screen that is easy to clean.

Specifications

- Powder Coated Paint with 12 gauge steel
- Steel stickmen with powder coat paint for hanging fire fighter personal protective equipment with 2" shut off valves
- High volume and high pressure system
- Enclosed motor with noise reduction package
- 360 degree swivel casters on the base
- Removable motor and fan with 360 degree swivel casters with easy quick connect attachment to dryer
- Motor and Fan with an optional 4" or 6" hose barb attachment for drying pumper truck
- 12 accessory drying ports with valves for gloves, helmets, balaclavas
- Operates on a 120v power supply



TG-4

TG-4

72.2 x 28 X 77.8 in

TG-6

TG-6

93.7 x 28 x 77.8 in

TG-8

TG-8

111.7 x 28 x 77.8 in

(Optional inline heater upgrade available, call for pricing)

HOW CLEAN AND DRY IS YOUR GEAR?

Special-Ops Gear Dryers 4-Place Immersion/Hazmat Bunker Gear Dryer

When you have special ops teams, Ram Air's 4-IHT model is your solution for proper gear drying. By allowing for inverted drying, the 4-IHT is able to dry hazmat, immersion and ice-rescue suits that standard gear dryers cannot accommodate while still drying standard bunker gear and accessories. Adjustable to any size gear, the 4-IHT quickly and efficiently dries personal protective equipment without turning gear inside out and causing damage to the gear. Gone are the days of hosing down gear and waiting days for it to dry. With Ram Air's immersion/hazmat/turnout gear dryers you can rest assured that your gear will be ready when you are!

ADJUSTABLE FOR ANY SIZE GEAR

Gear designed for special emergencies can be large and awkward to handle. Ram Air can accommodate the unique sizes of hazmat, immersion and ice-rescue suits easily. Each of the machine's four drying positions features adjustable height stickmen to that can be shortened or extended based on the size of the garment.

FULLY NFPA COMPLIANT

Since Ram Air's 4-IHT models operate using ambient air, manufacturer's warranties remain intact and the units comply with NFPA 1851/FEMSA recommendations for drying gear.

KEEPING YOU DRY FROM HEAD TO TOE

Working in dry boots, gloves, face masks and SCBA's makes doing your job safer and more comfortable. Ram Air's 4-IHT models feature 12 component ports for safely and quickly drying all gear accessories.

QUALITY CONSTRUCTION YOU CAN COUNT ON

Providing top-quality products is our top priority. Heavy-duty casters provide mobility for the unit; top-quality steel construction of the frame and air passages ensure that Ram Air gear dryers are built to last; and a LED timer with automatic shut-off provides easy, efficient drying. We don't just stand by our products, we guarantee them for a full two years!

TOUCH SCREEN CONTROL FOR DRYING WITH AMBIENT OR HEATED AIR

Same as opposite page

Specifications

- Powder Coated Paint with 12 gauge steel
- Steel stickmen with powder coat paint for hanging fire fighter personal protective equipment
- Stickmen can be inverted to accommodate garments needing to be dryer upside down, and the length is adjustable to accommodate different sizes of suits
- High volume and high pressure system
- Enclosed motor with noise reduction package
- 360 degree swivel casters on the base
- Removable motor and fan with 360 degree swivel casters with easy quick connect attachment to dryer
- Motor and Fan with optional 4" or 6" hose barb attachment for drying pumper truck
- 12 accessory drying ports with valves for gloves, helmets, balaclavas
- Operates on a 120v power supply



T4-IHT

80 W x 28 D x Adjustable Height up to 97in

(Optional inline heater upgrade available, call for pricing)



HOW CLEAN AND DRY IS YOUR GEAR?

NEW!

LION Victory™ Gloves

Nothing feels better than Victory™

Flexible from the start thanks to 3-D structural glove design & unique materials, the new Victory glove offers the ultimate in comfort, features & protection at a fraction of the price.

- Advanced 3-D design featuring soft, yet durable, goatskin fourchettes provides maximum dexterity
- Heat-resistant, flexible, and water-repellent goatskin split leather outer shell
- Aramid wool blend inner layer with added padding on the back of hand to increase thermal protection
- GORE® CROSSTECH® moisture barrier for lightweight, breathable, superior liquid penetration protection
- Palm layers stitched down with 100% Kevlar® high-burst thread for a stronger grip
- Leather pull-tab for easy donning and doffing



LPGVCTRY
Victory

**NY State Contract
Pricing Available -
Call for pricing*



LPG928BK
Commander Ace
Gauntlet



LPG927BG
Commander
Gauntlet



LPG955
Primus Gauntlet

NFPA 1971 Gloves Sizes XXS thru 4XL Cadet sizes available

LION Victory™

Maximum Dexterity. Minimum Price.

LPGVCTRY Victory™, Cognac/Black, Goatskin split leather. Aramid™ wool blend inner layer. CROSSTECH® moisture barrier

LION Commander Ace™

LPG928BK Commander Ace™, Black, premium split leather. CROSSTECH® insert w/ film technology and Kovenex® liner. Lite-N-Dri™ thermal protection in knuckle panel and enhanced gauntlet cuff.

LION Commander™

Extreme Dexterity for Extreme Firefighting

LPG926BG Commander™, Black/Gold, premium split leather w/ Kevlar® knit wristlet. CROSSTECH® Direct Grip® insert.

LPG927BG Commander™, Black/Gold, with gauntlet cuff.

LION Primus®

Advanced Structural Firefighting Glove

LPG955 Primus®, Black/Gray, premium split leather and grain goat skin. CROSSTECH® insert with film technology and Kovenex® liner. Lite-N-Dri™ thermal protection in knuckle pad and enhanced gauntlet cuff.



LPGEMS1
Bravo™ XT



LPGMXXT
Xtreme



LPGMX90
Cold Weather Work



LPGMX52
Work Glove



LPGMX80G
Work Glove



**NY State Contract
Pricing Available -
Call for pricing*

LION Bravo™ XT- Rescue Gloves, NFPA 1999

LPGEMS1 **Bravo™ XT**, synthetic leather shell, CROSSTECH® insert with film technology, comfort lining, knuckle guards and adjustable cuffs.
Sizes S-2XL

LION Xtreme - Extrication Gloves, Non-NFPA

LPGMXXT **Xtreme**, extrication and technical rescue glove with "Hi-Vis" padded knuckles and Armortex® palm pads.
Sizes S-2XL

LION Mechflex Mechanic's Specialty Gloves, Non-NFPA

LPGMX90 **Cold Weather Work Glove**, "Hi-Vis" lime back, black pig palm. Waterproof.
Sizes S-2XL

LION Mechflex Mechanic's Gloves, Non-NFPA

LPGMX80G **Work Glove**, "Hi-Vis" lime green, goat skin, black/lime/silver
Sizes S-2XL

Discontinued - Call for closeout prices.

LPGMX52 **Work Glove**, "Mechflex Impact," synthetic leather w/padded palm, black
Sizes S-2XL

Majestic Fire Apparel Premium Structural Firefighting Glove
MFA72 Gauntlet
MFA73 Wristlet

Kangaroo leather glove featuring enhanced 3D design, superior protection and unsurpassed dexterity. Remains soft after repeated washings.

- Fold over seamless fingers
- Digital textured kangaroo palm and fingers provide outstanding durability, grip and protection while remaining ultra-thin & highly protective
- Porelle® FR breathable moisture barrier for optimal fire, moisture, and Blood Borne Pathogen protection
- High-performance Kovenex® offers true flame resistance with heat blocking protection
- Extended 3" long debris cuff with cinched wrist for added protection
- NFPA 1971 - current edition
- Sizes: XXS-XL, *2X-3XL



MFA72 Gauntlet

Majestic Fire Apparel Structural Firefighting Glove
MFA82 Gauntlet
MFA83 Wristlet

Our MFA82 & MFA83 are manufactured using a Kovenex inner liner, an added layer of palm protection and enhanced 3D design features making them among the most competitively priced gloves with enhanced features on the market.

- 3D design in both gauntlet & wristlet styles
- SEI certified to the specifications of NFPA 1971 - current edition
- Extremely protective Ever-Soft leather with a TPP value of over 60 cal/cm²
- Easy donning and doffing with a very comfortable Kovenex inner liner that is both bonded and sewn into the fingertips to help prevent liner pull-out
- Pyroprotect Moisture Barrier keeps hands dry and defends against blood-borne pathogens and hazardous liquids
- Gathered Close Fitting Wrist in the MFA82 glove along with an inside leather hang loop
- MFA83 has a Kevlar wristlet with leather pull
- Sizes: XXS-XL, *2X-3XL



MFA82

MFA83

Golfire Glove Keeper II
GK2

- Wraps around any glove size
- The mail/female connector clips together with ease and is then cinched tight with the D-ring.
- To release the gloves, simply pinch the connector
- State-of-the-art fit and fabrics minimize fatigue
- Attaches to your gear with a heavy duty shap hook
- Available in Black or Yellow (other colors available)



GK2

Extrication Hybrid Gloves - Hi Vis Ringers Model 337

- ResQLoc Grip System
- Supercuff Technology
- CE Certified Puncture and Cut Protection
- TPR Impact Protection on Top of Hand and Full Length of Fingers
- High Visibility for Increased Safety
- Neoprene cuff with gaiter closure to keep out debris
- Sizes S-2XL



Barrier 1 Extrication Gloves - Hi Vis Green Ringers Model 327

- Waterproof and breathable Hipora® barrier to protect hands from micro-organisms such as TB, Hepatitis, Staph and HIV meets O.S.H.A. Bloodborne Pathogens Standards (29CFR 1910.1030)
- Boxed finger tip design for better fit and comfort
- Elastic cuff and gaiter to keep out glass and debris
- Kevlar® stitching in high wear areas
- Molded TPR (Thermal Plastic Rubber) knuckle reduces impact, increases dexterity and features 3M™ Reflective fabric
- Molded TPR finger knuckle and finger tip panels
- Cut resistant Kevlar® palm and thumb panels, side panels and finger panels
- Non-reflective Armortex® knuckle
- Sizes S-2XL



Warrior Extrication Gloves Firecraft Model FX-95MB

The first glove to combine the liquid penetration protection of Porelle® with the level-4 cut resistance of Spectra®

The FX-95MB has a Porelle® FR certified moisture barrier. This is the same moisture barrier used in FireCraft's firefighter gloves. It allows your hands to expel moisture and still protects them from chemicals and blood pathogens.

- Spectra® inner liner provides level-4 cut protection (used in body armor!)
- Outstanding Dexterity and Fit
- Silky liner for easy on/off, even when wet!
- State-of-the-art fit and fabrics minimize fatigue
- Hi-Vis Yellow fabric
- Sizes XS-3XL



LION'S RedZone™ Particulate-Blocking Hood THE BEST PROTECTION IS PREVENTION.



LION's RedZone™ Particulate-Blocking Hood protects one of the most vulnerable areas of your body by blocking contaminants from touching your head or neck. Its streamlined, two-layer construction features StedAir® PREVENT particulate blocker for outstanding contaminant protection, wash after wash. RedZone™ also offers exceptional breathability, comfort and mobility. And it doesn't restrict your hearing during firefighting activities.

- Total particulate protection throughout
- Air-permeable to help manage core temperature and heat stress
- Streamlined, two-layer construction for easy movement, flexibility and unobstructed hearing
- Extended bib design provides optimal shoulder and neck coverage that stays in place
- Ultra-soft, flame-resistant (FR) material for maximum comfort and fire protection
- Extreme durability that maintains its particulate blocking effectiveness even after 100 washes
- Universal sizing that comfortably fits all heads
- Available in Black/Gray and Tan/Gray

HD395142 – LION Particulate Hood, Black/Gray

HD395416 – LION Particulate Hood, Tan/Gray



HD395142



HD395416

MAJESTIC HOODS



HOOD-BC



HOOD-PBI



HOOD-NOM



Majestic's PAC II Hoods

PAC II Hoods offer more square inches of protection and is their most popular NFPA approved hood style. The notched shoulder and longer length allows for a proper fit and added protection across the chest. The longer length (3 inches longer than NFPA requires) assures that this hood will stay tucked inside other required equipment. NFPA 1971, UL Certified. Meets or exceeds Cal/OSHA Standards.

- HOOD-BC** Ultra C6 Carbon Blend Double layer hood and bib
- HOOD-PBI** PBI Double layer hood and bib
- HOOD-NOM** Nomex Blend Double layer hood and bib



007 The Ultimate Gear Bag

- Huge 4.5 cubic ft. of interior storage
- Four outside pockets
- Firefighter's Maltese Cross emblem
- Lime Hi-Viz Reflective Trim
- Metal Zippers, Buckles and Strap Loops
- Back panel opens to reveal a mesh vent window
- Includes Shoulder Strap



007-WH The Ultimate Gear Bag with WHEELS

- Durable Wheels with Reinforced "Skid Pads"
- Huge 4.5 cubic ft. of interior storage
- Back panel opens to reveal a mesh vent window
- Reflective trim along straps
- Firefighter's Maltese Cross emblem
- 600 Denier
- Main Compartment: 18" x 17" x 16"
- Overall Dimensions: 29" x 17" x 16"
- Includes Shoulder Strap



911-84681 Step-In Gear Bag

- Keeps your turnout gear ready to go.
- Heavy duty carry straps for easy transport.

Outside: 19.5"H x 15.5"W x 17"D



196FF-XL Pink Gear Bag

- 25% larger than the average gear bag
- YKK self repairing nylon coil zipper
- Designed to hold turnout coat, pants, helmet & boots
- 1/2" web handle
- Compartment measures: 13 1/2" x 16" x 24"
- Made of heavy Cordura® nylon w/ a urethane coated back
- Logo: "Fire Fighter" wording only, in black print
- 5,200 cu. in. Wt. 30 oz.



**NY State Contract
Pricing Available -
Call for pricing*

*Need more
head room?*

AMERICAN LEGEND

LFH9120I

Legend features a *Retractable Eye Guard*

- Ratcheting headband adjusts from head sizes 5.5 to 9
- Weight: 59oz.
- A SMC fiberglass shell with a powder coat, impact-resistant finish
- Available in Black, White, Red and Yellow
- Washable, replaceable Nomex and flannel ear/neck covers
- Patented Center of Gravity™ adjustment system for a custom fit

AMERICAN LEGEND X

LFH8120E

Legend X features a 4" faceshield

- Same as features as Legend, except:
- Ratcheting headband adjusts from head sizes 5.5 to 9.5
- Weight: 53-59oz.

LFH8120S

with ESS goggles

LFH8120D

with ESS goggles and flip downs

LFH8120F

with flip downs only (Non-NFPA)



AMERICAN HERITAGE

LFH4120E

LION American Heritage in rich leather with a 4" faceshield. A unique Leather Glass process which molds fiber glass composite between the outer and inner layers of the leather shell. Features 3M Scotchlite lime yellow, ratcheting headband cushioned with foam and covered with sleeve leather, quick release chin strap with postman's slide. Features Center of Gravity adjustment System.

LFH4120S

with ESS goggles

LFH4120D

with ESS goggles and flip downs

LFH4120F

with flip downs only (Non-NFPA)

AMERICAN CLASSIC

LFH2120E

LION American Classic in fiberglass w/ a 4" faceshield. A Thermax composite to ensure thermal protection, lightweight and structural integrity. Features 3M Scotchlite lime yellow, ratcheting headband cushioned with foam and covered with black knit, quick release chin strap with postman's slide. Features Center of Gravity adjustment System.

LFH2120S

with ESS goggles

LFH2120D

with ESS goggles and flip downs

LFH2120F

with flip downs only (Non-NFPA)

AMERICAN LEGACY

LFH3910A

Legacy 5 w/ 4" faceshield features a fiberglass shell, 3M Scotchlite lime yellow, ratcheting head band cushioned with foam, quick release chin strap with postman's slide, Center of Gravity adjustment system and an impact cap. Features the Spring-Loaded Safety-Set Bracket/WaterGuard Seal.

LFH3910S

with ESS goggles

*Helmets on this page are shown with optional leather fronts.
*Most helmets are available in your choice of Yellow, Black, White, Red, Blue, Green, or Orange. All Green and Orange helmets have longer lead times and are an additional charge.

LION Patent Leather Front

- Patent leather front shield for our LION helmets
- Available with two or three panels
- Not available with insignias, medallions or any other decorations

(Order Installed or Loose)

**NY State Contract
Pricing Available -
Call for pricing*



GOLFIRE SHIELDS

Golfire Shields are made from three layers of 100% Leather. Panels are made from engineered grade vinyl for long life! Each shield is hot glued and stitched to last a lifetime! All shields include metal backer bars!

Many custom designs options and styles are available!

- GF4SHIELD - 4" Leather Front -**
- GF6SHIELD - 6" Leather Front -**



Standard Leather Colors are Red, Black or White (Other Colors available - Call for pricing)

Additional Options: Decal, Medallion, Passport, Flag, Colored #'s, Patent Leather - Call for pricing

Gold Leaf Shield, Standard CHIEFIMITATION -

Golfire's Custom Chief Officers Shields are made from rigid metal and 100% leather. Using a metal front plate allows the imitation gold/silver to adhere to the front properly giving it long lasting durability. The metal plate is then sewn onto a 100% leather backing. Included is the metal backer bar. Available in Gold Leaf or Silver Leaf Florentine.

**Please contact us for ordering information and forms.*



Golfire Key Chain Shields

KEY -

- 2" x 3" • 3 layers of 100% leather sewn together • Available in red, black, and white
- Panel and letter colors are unlimited
- Up to three leather numbers can be sewn in between the panels.



PAUL CONWAY FRONTS

Paul Conway Shields are meant to last. The printing is hot-stamped in colors or foil. Every letter is seared into the surface of the leather, like a brand. There may be easier or faster ways of doing it. But we wouldn't put our name on them—or yours.

Standard 4" or 6" Leather Front

Additional Center Options:

- Decal
- Metal Disc
- Brass or Silver Ornament

*To order shields, please fill out our **PAUL CONWAY** Leather Front forms found on our website*



Reflective Helmet Crescents

These helmet crescents feature Black imprint on White reflective material.

11-106 ASST. CHIEF	11-133 FIREFIGHTER
11-109 BATTALION CHIEF	11-138 FIRE POLICE
11-111 CAPTAIN	11-141 1ST ASST. CHIEF
11-113 CHIEF	11-148 LIEUTENANT
11-117 COMMISSIONER	11-162 2ND ASST. CHIEF
11-120 DEPUTY CHIEF	11-166 3RD ASST. CHIEF



Other titles available

Reflective Helmet Decals

These helmet decals are 3" and feature Red imprint on White reflective material. The bottom line is imprinted FIRE DEPT., except for 07-118 which has no bottom imprint. Top line as shown below.

07-101 ASST. CHIEF	07-110 DEPUTY CHIEF
07-104 BATTALION CHIEF	07-118 FIREFIGHTER
07-105 CAPTAIN	07-122 FIRE POLICE
07-108 CHIEF	07-128 LIEUTENANT



07-108

CUSTOM DIE CUT DECALS

These decals were designed especially for fire helmets. Their special die cut design allows them to easily adhere to the shape of the front of helmets. They are made of reflective material with the adhesive on the back.

*When ordering please specify: Model number, color of imprint, top line wording and bottom line wording.

*Price includes one color imprint, add 25% for each additional color.

Note: These are custom made deals and are absolutely not subject to cancellation or return.



#FPD-4275 - Size 4" Wide
(not shown actual size)

#FPD-4275 - Size 4" Wide
(not shown actual size)

Qty	10	26	51
Price ea.			



#FRT-3547 - Size 4 1/4" Wide
(not shown actual size)

#FRT-3547 - Size 4 1/4" Wide
(not shown actual size)

Qty	10	26	51
Price ea.			

set-up fee

Minimum order
10 pieces

SMITH & WARREN

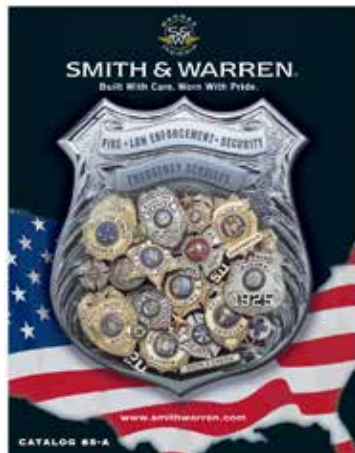

We carry a full line of
Smith & Warren Badges



LION Flip Down Eye Shield

LION Flip Down Eye Shield

Non-NFPA flip down eye shield for use on LION American Classic or American Heritage fire helmets

LFH977



LION 4" Faceshield Replacement

LION 4" Faceshield (Thumbwheel Style)

Fits LION American Classic or American Heritage fire helmets

LFH974



ESS Innerzone Two Goggles

The Innerzone 2 goggle is designed to be worn with or without a face shield. The Innerzone 2 features snap-on/snap-off brackets which allow storage of the goggles in your pocket or the back of the helmet. They also feature a quick adjustment headband, antifog inner surface, and a Hardcoated polycarbonate lens.

Innerzone 2 goggles are NFPA compliant.

You can retrofit these to your existing helmet in minutes.

ESS-01-GY2-WF



Portwest Wrap Around Plus Glasses

Our best selling Wrap Around Glasses are now available with additional edge protection, thanks to the removable gasket, which offers a super comfortable fit and optimal protection against dust and impacts. The lens is treated with anti-scratch and anti-fog coating for improved performance. Detachable foam offers additional protection against shocks and dust

Meets:

ANSI/ISEA Z87.1 + U6L3

- Lightweight wrap-around design
- Flexible arms for ultra comfort
- Single panoramic lens glasses
- Soft arms tips for ultra comfort
- Available in multiple colourways
- Excellent side protection
- Anti-fog coating for additional comfort to the wearer
- Anti-scratch coating for added durability
- 99% UV protection

PS32CLR



Portwest Tech Look Plus

Dielectric safety glasses with metal free hinges features a tough and modern design with dual material on the side arms. The wide elastic band ensures an improved fit and can be easily combined with helmets and ear defenders. The removable EVA foam gasket allows extra comfort and offers additional protection against shocks and dust.

Meets:

ANSI/ISEA Z87.1 + U6L3

- Soft arms tips for ultra comfort
- Dual use with classic arms or with wide elastic band
- Detachable foam offers additional protection against shocks and dust
- Flexible arms for ultra comfort
- Side vents for added comfort
- Anti-fog coating for additional comfort to the wearer
- Anti-scratch coating for added durability
- 100% metal free
- 99% UV protection

PS11CLR

FIRE BOOTS THAT DON'T STOP UNTIL YOU DO

High-Performance First Responder Footwear produced by Thorogood

With dozens of options available, how do you choose the right firefighting boots? A comfortable boot is essential to safety on the fireground because, when your feet hurt, you can lose mobility and stamina. LION Fire Boots by Thorogood brings superior working comfort, safety, and durability.

Working Comfort - Rugged, strong and flexible- everything you want in a firefighting boot. Designed to anatomically match the shape of your heel, and ankle guards that provide a comfortable athletic fit.

Safety - Simply because safety is paramount, we build in the following attributes throughout our boot line; high traction, flexible cement construction, steel, triple rib ladder shank, impact-resisting ankle protection, Lenzi® midsole, and oversized ladder shin guard.

Quality - Our boots have their own unique style, but more importantly, our boots are built to last. Utilizing quality leather, break-through technology in heel padding, safety toe design, and various rugged outsoles, we are confident your boots will stand-up to the multiple tasks you perform every day.



KnockDown Elite – 14" Pull-On Leather Structural Boot 804-6389 (men's) 504-6389 (women's)

- GORE® CROSSTECH® triple-layer moisture barrier protects against blood-borne pathogens
- Waterproof, flame-resisting leather upper with abrasion-resisting rubber toe and heel protection
- Removable dual-density polyurethane insole
- Lenzi L-Protection® flexible, non-metallic, puncture-resisting insole
- Steel triple-rib ladder shank
- Exclusive Vibram® ATS sole with Fire & Ice technology
- Cement construction
- Certified to meet NFPA 1971 structural & NFPA 1992 liquid splash
- Meets ASTM F2413-11
- CSA Z195-14 Edition-7



QR14 –14" Pull-On Leather Structural Boot 804-6369 (men's) 504-6369 (women's)

- GORE® CROSSTECH® triple-layer moisture barrier protects against blood-borne pathogens
- Waterproof, flame- and cut-resisting leather upper with abrasion-resisting rubber toe
- Steel Triple-Rib Ladder Shank
- Proprietary Traction Flex outsole
- Cement Construction
- Certified to meet NFPA 1971

**NY State Contract
Pricing Available -
Call for pricing*



USA Oblique – 14" Pull-On Leather Structural Boot 804-6373 (men's) 504-6373 (women's)

CALL - Closeout Boot

- Full-grain, flame-/abrasion-resisting leather/Vibram® rubber toe & heel bumper
- Removable Dual-density polyurethane footbed
- Lenzi L-Protection® flexible, non-metallic, puncture-resisting insole
- Steel Triple-rib Ladder shank
- Exclusive Vibram® Chiseled Edge Fire & Ice sole
- Goodyear Storm Welt construction
- Certified to meet NFPA 1971
- Certified to meet ASTM F2413-11



HellFire Kevlar® Insulated –14" Pull-On Rubber Structural Boot
807-6000 (men's) 507-6000 (women's)

- Flame/heat-resisting rubber
- Removable Superknit covered, polyurethane footbed
- Steel Triple-Rib Ladder shank
- Stainless steel puncture-resisting bottom plate
- Hellfire traction lug sole
- Abrasion-resisting rubber T-toe
- Vulcanized construction
- Certified to meet NFPA 1971 structural and NFPA 1992 liquid splash



HellFire Felt Insulated – 14" Pull-On Rubber Structural Boot
807-6003 (men's) 507-6003 (women's)

- Flame/heat-resisting rubber
- Waterproof
- Removable Superknit covered, polyurethane footbed
- Steel Triple-Rib Ladder shank
- Stainless steel puncture-resisting bottom plate
- HellFire traction lug sole
- Abrasion-resisting rubber T-toe
- Vulcanized construction
- Certified to meet NFPA 1971 structural and NFPA 1992 liquid splash



Station 1 – 9" Lace-Up/Zip EMS/Wildland Leather Boot
804-6379 (men's) 504-6379 (women's)

- GORE® CROSSTECH® Waterproof Lining
- Full-Grain, Flame/Cut-Resisting Leather
- Steel Triple-Rib Logger Shank
- Exclusive Vibram® ATS Outsole
- Cement Construction
- Certified to meet NFPA 1999 EMS and NFPA 1977 Wildland

**NY State Contract Pricing Available - Call for pricing*

LION by Thorogood Boot Sizing:

KnockDown Elite, QR14, USA Oblique, HellFire Felt Insulated and HellFire Kevlar Insulated:

Men's Sizes – 5-16 (by half sizes)

Widths – medium, wide and x-wide

Women's Sizes – 5-10 (by half sizes)

Widths – narrow, medium and wide

Station 1:

Men's Sizes – 5-15 (by half sizes)

Widths – medium, wide and x-wide

Women's Sizes – 5-10 (by half sizes)

Widths – narrow, medium and wide

Call for pricing, as our price is below Manufacturer Advertised Pricing shown





507-502 Fire Eagle Air

- Leg Height: 11"
- HAIX® Ankle Flex System stabilizes the foot w/ a flexible insert in the shaft/instep area
- Composite protective toe cap
- HAIX® High Durability toe cap system
- Steel puncture protective sole
- HAIX® Boot Jack
- HAIX® Ankle Protector System
- Padded shin protection
- Slip resistant and highly heat resistant water ice grip rubber sole
- NFPA 1971 & 1992

Men 5-16, Whole and half sizes
Narrow, Medium, and Wide Widths



507-101 Fire Hero Xtreme

- Leg Height: 11"
- HAIX® Ankle Flex System stabilizes the foot w/ a flexible insert in the shaft/instep area
- Carbon protective toe cap
- Exterior profiled rubber toe cap
- Steel puncture protective sole
- HAIX® ES Out System offers a special heel edge for easier boot removal
- Padded shin protection
- Slip resistant and highly heat resistant water ice grip rubber sole
- NFPA 1971 & 1992

Men 5-16, Whole and half sizes
Medium & Wide Widths

***NY State Contract Pricing Available - Boots shown are in stock and ready to ship!**



501-605 Fire Hunter Xtreme

- Leg Height: 14"
- HAIX® Ankle Flex System stabilizes the foot w/ a flexible insert in the shaft/instep area
- Steel protective toe cap
- Exterior profiled rubber toe cap
- Steel puncture protective sole
- Padded shin protection
- Slip resistant and highly heat resistant rubber sole
- NFPA 1971 & 1992

Men 5-16, Whole and half sizes
Narrow, Medium, and Wide Widths



502-004 Fire Hunter USA

- Leg Height: 11"
- Steel protective toe cap
- Exterior profiled rubber toe cap
- Steel puncture protective sole
- Slip resistant and highly heat resistant rubber sole
- NFPA 1971 & 1992

Men 5-16, Whole and half sizes
Narrow, Medium, and Wide Widths

***All HAIX® Boots have the following standard features:**

- Secura Liner® – will never wrinkle up or pull out over time
- HAIX® Sun Reflect leather helps keep feet cooler in direct sunlight
- HAIX® MSL System (Micro Soft Light) PU foam injected throughout the sole for greater shock absorption and cold/heat insulation
- HAIX® Climate System keeps your feet temperature regulated
- Ladder shank for extra support on ladder rung
- Increased chemical protection and bloodborne pathogen resistance
- Larger boot straps placed below the topline so as not to rub the calf
- Waterproof/breathable with CROSSTECH®



Quad Certified

506-005 Fire Flash Xtreme

- Leg Height: 10"
- Secura Liner® – will never wrinkle up or pull out over time
- HAIX® Sun Reflect leather helps keep feet cooler in direct sunlight
- HAIX® MSL System for greater shock absorption and cold/heat insulation
- HAIX® Lacing System offers the optimal adjustment option, easy entry and exit of a zipper boot with the personal fit of a lace up boot
- HAIX® Climate System keeps your feet temperature regulated
- Steel protective toe cap & Steel puncture protective sole
- Exterior profiled rubber toe cap for added abrasion resistance
- Waterproof/breathable with CROSSTECH®
- Increased chemical protection and bloodborne pathogen resistance
- Slip resistant and highly heat resistant rubber sole
- For Structural & Wildland Fire Fighting, USAR, and Hazmat

* NFPA 1971, 1977, 1951, 1992

Men 5-16, Whole and half sizes
Narrow, Medium, and Wide Widths



605-128 Airpower® XR1 Pro

- Leg Height: 9"
- Dual Certified for Wildland Firefighting and EMS
- Waterproof and Chemical Protection with CROSSTECH®
- Slip and Heat Resistant Soles and Quick Drying Insoles
- HAIX® Sun Reflect leather keeps feet cooler in direct sunlight
- HAIX® Arch Support System supports your foot in its natural position
- HAIX® Climate System for temperature balance
- HAIX® Lacing System offers the entry and exit of a zipper boot with the personal fit of a lace up boot
- Carbon protective toe cap and exterior rubber toe cap
- Puncture protection sole
- NFPA 1977, 1999, 1951

Men 5-15, Whole and half sizes
Narrow, Medium, and Wide Widths

(*NY State Contract Pricing Available)



605-118 Airpower® XR2

605-122 Airpower® XR2 Winter

- Leg Height: 8"
- NFPA certified for EMS
- Waterproof and Chemical Protection with CROSSTECH®
- Slip and Heat Resistant Soles and Quick Drying Insoles
- HAIX® Sun Reflect leather keeps feet cooler in direct sunlight
- HAIX® Arch Support System supports your foot in its natural position
- HAIX® Climate System for temperature balance
- HAIX® Lacing System offers the entry and exit of a zipper boot with the personal fit of a lace up boot
- Lightweight composite toe cap and puncture protective sole
- NFPA 1999
- New XR2 Winter has newly developed rubber winter sole which is extremely slip-resistant on ice and snow.

Men 4-15, Whole and half sizes
Narrow, Medium, and Wide Widths



620-012 Black Eagle® Safety 55 Mid Side Zip

- Leg Height: 5"
- Station and EMS boot w/ NFPA certification
- Waterproof & Chemical Protection w/ CROSSTECH®
- Vario Wide Fit System for individualized fit
- Side Zip for easy on and off
- Slip Resistant Soles & Quick Drying Insoles
- Sun Reflect Technology and Secura Liner®
- Lightweight composite toe cap & puncture resistant midsole
- NFPA 1999

Men 5-15, Whole and half sizes
Women 5-10, Whole and half sizes

(*NY State Contract Pricing Available)



206-215 Airpower® P7 High

- Leg Height: 9"
- Law Enforcement boot
- CROSSTECH® inner liner, waterproof, breathable, bacteria, chemical, & bloodborne pathogen resistant
- HAIX® Arch Support System
- Fuel, oil, and skid resistant sole
- HAIX® Climate System
- Sun Reflect leather
- Antistatic

Men's 5-15 Whole and half sizes
Women 5-10, Whole and half sizes



206-214 Airpower® P7 Mid

- Leg Height: 6"
- Law Enforcement boot
- Secura Liner®— never a loose liner
- CROSSTECH® inner liner, waterproof, breathable, bacteria, chemical, and bloodborne pathogen resistant
- HAIX® Arch Support System
- Fuel, oil, and skid resistant sole
- HAIX® Climate System
- Sun Reflect leather
- Antistatic

Men's 5-15 Whole and half sizes
Women 5-10, Whole and half sizes



Black Eagle Tactical 2.0 GTX

- Innovative Footwear with Upgraded Features
- Shock Absorbent with Spring-Back Material
- Durable, Oil, and Gas Resistant Soles
- Perfect Climate Comfort during every weather
- Perfect fit even with wide or slim calf
- Waterproof/breathable with GORETEX® Extended
- Metal Free, Anti-static

Sizing 4-16 Whole, Half Sizes 4.5-12.5

340001 Low: 3"
340002 Mid: 6"
340003 High: 8"



330-016 Black Eagle Athletic Low

- Leg Height: 3"
- Based on Innovative Technology & All Day Functionality
- Lightweight and highly breathable shoe
- Cutting Edge Technology for All Day Wear
- Slip Resistant Soles with Multi-Directional Anti-Slip Grip
- Stabilization and Dynaframe Construction
- Moisture-Absorbent Insole and Breathable Microfiber Design
- Smart Lacing System

Sizing 4-16 Whole, Half Sizes 4.5-12.5
 Narrow, Medium, and Wide Widths



277-0912 The X2 Boot

- Leg Height: 14"
- FireTuff™ Leather Upper - Fireproof
- Fusion™ Upper -solution dye of Nomex®/Kevlar® and Teflon®
- Exclusive 3-Point Heel Lock for Fit & Comfort
- CROSSTECH™ Fabric with Omaha lining
- Kevlar® lined for maximum protection
- Comfort form-fitting shin-guard
- Rubber Toe Cap for high abrasion
- Stainless Steel Toe, Midsole, & Shank
- Integrated & Reinforced Loop Pull-On System
- NFPA 1971

*All Sizes Fit 3 Widths
Medium, Wide, & Extra-Wide
Whole 6-15, Half 8 1/2 - 11 1/2



690-9451 16" Comfort Fit Bunker

- Foam insulation
- KEVLAR/NOMEX leg lining
- Tibia Guard
- Black K-Lug outsole
- Steel toe and midsole
- Meets NFPA 1971
- Comfort Fit -order same as shoe size

* Whole sizes 4-15, Half sizes 8 1/2-11 1/2
Medium or Wide



9203 31" Insulated Rubber Boot

- Felt Lined
- Non-NFPA

* Whole sizes only 7-15
Medium width only



***Call for all Black Diamond Boot pricing**

BOOT ACCESSORIES



Shoe Polish specially developed for HAIX® Sun Reflect leather - caring and impregnating shoes made of smooth leather. Gives the leather a new shine, and additional waterproof protection while maintaining breathability.

900060 - Haix® Black Shoe Polish - Tube

900160 - Haix® Black Shoe Polish - Bucket

Remove your HAIX® boots without having to bend down.
Made of solid wood and branded with the HAIX® logo.

904000 - Haix® Boot Jack





6543



6543R



5425



5425R



5481RC-E



Fireman's Radio Strap

6543

6543R (Reflective)

• 1 1/4" wide heavy duty leather

• Leather mic loop • Positive locking buckle

• Mates to a radio holder (sold separately) with rust free scissor snaps

6543XL (8" Longer)

6543RXL (8" Longer)

Fireman's Universal Radio Holder w/ D-Rings & Elastic Strap

5481RC-E

• The same as radio holder style 5481, with D-rings and elastic strap.

• Full leather case Adjustable, Hook and Loop lined top strap.

• Uses D-rings to mate with firefighter's radio strap.

• Holds Motorola HT90, MTX 900

Measurements:

• Interior Width : 2.9" • Interior Depth (Front to Back) : 1.4"

• Front Height : 4" • Back Height : 6"

Fireman's Anti-Sway Strap

5425

5425R (Reflective)

• Clips to the radio strap & your turnout gear to keep your radio close

• Heavy duty leather

Fireman's Leather Suspenders

9175

• Standard Firefighter Suspenders, button loop

• 1 1/2" Wide Adjustable Straps

• Roller Buckles

GRIME BOSS WIPES



GRIME BOSS Wipes Make Cleaning Up After The Fire So Easy!

Great for cleanup of hands, face, truck, tools & equipment after fires!



• Removes ash, soot, grime, grease, fine debris and dust

• Cleans masks, tools and truck parts

• Effective without using harsh chemicals

• Made in USA

M956S8X 60 Count Pack

***GB956WBM** Mounting Bracket

* The GB956WBM has been discontinued, limited to supply on hand.

NEW!

LION TRAINING TOOLS



FIREFIGHTER TRAINING PROPS TO HELP YOU TRAIN FOR EVERY CALL

Fighting fires is serious business. You put your safety and health at risk with every call, so you train and work hard learning firefighting techniques to make sure you are prepared for whatever that next call requires.

LION firefighting training props meet that call. They are designed to meet the needs of your fire academy training, fire department training drills, and large-scale training sessions. We make versatile products that can be used over and over again in a variety of scenarios.

LION makes smoke generators to create realistic training environments and rescue mannequins with thermal signatures and voice boxes so they can cough or call for help. We also make the Attack Digital Fire System to simulate lights and fire and a digital nozzle so you can train without water in whatever environment you need.

We also make prop vehicles so your team can learn how to respond to vehicle fires and practice the techniques they need to put those fires out fast. From pressure vessels and automobile props to helicopter training and aircraft wing props, we help you develop the skills you need to get the job done.



BullsEye™ Digital Fire Extinguisher Training System



Attack™ Digital Fire Training System

Entire line available - please call for more information and pricing



Smoke Generator



I.T.S. Xtreme™ Extinguisher Training System



Gastrainer™ System



Thermal Mannequin



Vehicle Fire Training Prop

Tactix® TR51™

Coat & Pant

Sigma™ Tan/Black or Yellow



Available in the following sizes:

Coat Chest	36" - 56" (even sizes only)
Pant Waist	30" - 56" (even sizes only)
Inseam	XS (26"), S (28"), M (30"), L (32") or XL (34")

*Certified to NFPA 1951 and NFPA 1999

LION TACTIX TR51™ TECHNICAL RESCUE ENSEMBLE

A versatile, dual-certified technical rescue outfit – comfortable and lightweight. Certified to meet NFPA 1951 Technical Rescue and Recovery Requirements and NFPA 1999 when shell and moisture barrier/liner are both worn. Certified to meet NFPA 1951 Technical Rescue Utility Requirements when shell is worn without moisture barrier/liner.

Sigma™

CSRM 29" or 32" Length

Coat Features:

- Bi-swing back and underarm bellows
- Self-fabric elbow reinforcements
- Self-fabric cuff reinforcements with hook and loop and dee ring adjusters
- 3" overlapping collar
- Thermoplastic zipper front closure with internal storm flap and water channel
- Removable CROSSTECH® S/R moisture barrier liner
- Garment is certified to NFPA 1951 Utility when shell only is worn
- 3" NFPA coat trim pattern (additional charge)

Sigma™

PSRM TR51 Pant

Pant Features:

- Self-fabric knee reinforcements
- Pants cuffs have self-fabric reinforcements & self-fabric hook & loop & dee ring adjusters
- Thermoplastic zipper with hook and loop and snap storm fly closure
- Postman-style take-up straps at waist
- Low-rise contoured waist band
- Self-fabric reinforced seat
- Removable CROSSTECH® S/R moisture barrier liner
- Garment is certified to NFPA 1951 Utility when shell only is worn
- 3" stripe above pants cuffs (additional charge)

ADDITIONAL OPTIONS AVAILABLE

Coat

RP553 Radio/Flashlight Pocket
 HP597 Pr. 9" x 7" x 2" combination pkts
 MT503 Mic Tab Self Fabric
 FLS556 Flashlight Hook
 HD001 Hide-away Hood with pull string
 MP713 3.5" x 5.5" Patch Pocket
 MP546 5" x 6" Patch Pocket
 SF224 External 2.5" Storm Flap
 LP1/LPV2 One line letter Patch w/ velcro
 3" Sewn on letters
 FSRM/F Nomex Fleece Winter Liner (CC714 & FF225)

Pant

FBP574 Pr. 8" x 8" x 2" Full Bellows Pkt
 BHS013 2" KEVLAR belt
 PMO206 2 Layer Padded Knee
 PMO209 4 Layer Padded Knee
 PMO1/PLW222/PC515 18" Zipper Leg

7.0 oz./yd2 Sigma™ Tan, Black or Yellow

Call for your custom specification quote.

MEDPRO™ Coat & Pant

Westex® Navy or Hi-Viz Yellow



Available in the following sizes:

Coat Chest	36" - 56" (even sizes only)
Pant Waist	30" - 56" (even sizes only)
Inseam	XS (26"), S (28"), M (30"), L (32") or XL (34")

***Certified to NFPA 1999**

LION MEDPRO EMS ENSEMBLE

Designed specifically to meet the demanding needs of today's EMS professionals. LION's MedPro EMS coat and pant combination features advanced construction and optional enhancements that ensure on-the-job comfort, safety and mobility. The outer shell is constructed of Westex® DH fire-resistant breathable fabric with Hypropel Premier finish and a CROSSTECH® EMS moisture barrier.

Westex® Navy **Westex® Hi-Vis Yellow**
(Certified to Meet ANSI 107)

CEMSM/F 29" or 32" Length

Standard on coat:

- Bi-swing back and underarm bellows
- Polymer-coated aramid elbow reinforcements
- Self-fabric cuff reinforcements with hook and loop and dee ring adjusters
- 3" overlapping collar
- Thermoplastic zipper front closure with internal storm flap and water channel
- Trim for NAVY Coat: 3" NFPA Scotchlite Ventilated Trim Yellow/Silver or Red/Silver (additional charge)
- Trim for HI-VIZ Coat: 2"Hi-Vis pattern Scotchlite Trim in Silver

Westex® Navy **Westex® Hi-Vis Yellow**
(Certified to Meet ANSI 107)

PEMSM/F MedPro Pant

Standard on pants:

- Polymer-coated aramid knee reinforcements
- Pants cuffs have polymer-coated aramid reinforcements and self-fabric hook and loop and dee ring adjusters
- Thermoplastic zipper with hook and loop and snap storm fly closure
- Postman-style take-up straps at waist
- Low-rise contoured waist band
- Self-fabric reinforced seat
- Banded crotch gusset
- Zippered leg
- Trim for NAVY Pant: 3" NFPA pattern Scotchlite Ventilated Trim Yellow/Silver or Red/Silver (additional charge)
- Trim for HI-VIZ Pant: 2"Hi-Vis pattern Scotchlite Trim in Silver

ADDITIONAL OPTIONS AVAILABLE

Coat

- MT550 1" x 2" self-fabric mic tab on right chest
- RP514 3.5" x 9" x 2" radio pocket on right chest
- MP2020 8.5" x 11.5" Napoleon pocket on chest
- HP644 8" x 8" x 2" semi-bellows and handwarmer pockets on hem
- HD004 Three piece self-fabric hood lined with moisture barrier
- PFRCM Winter liner
- EM09 Blue 3" star of life emblem
- LP1/LPV2 One line letter Patch w/ velcro
- 3" Sewn on letters

Pant

- LSA702 Eight (8) suspender buttons if you will be wearing suspenders
- BL005 Three (3) belt loops if you will be wearing a belt
- SBP614 8" x 8" x 2" semi-bellows pocket on left thigh
- FBP574 8" x 8" x 2" full bellows on right thigh
- BHS013 2" Kevlar belt



Call for your custom specification quote.

VersaPro™ Coat & Pant

Sigma™ Tan or Black



**Upgrade to the LION VersaPro PLUS - please call for pricing (shown on left)*

***Certified to NFPA 1951 and NFPA 1977**

LION VERSAPRO™ COAT & PANTS

Dual-Certified Multi-Purpose garment stands tall for most non-structural situations.
• NFPA 1951 Utility Certified & NFPA 1977 Wildland Certified

Ready for the Job at Hand

- Meets the wide variety of situation encountered by firefighters on a daily basis
- More protection than a station uniform
- Less cumbersome than structural turnouts for non-structural calls

Versatility Meets Comfort

- Lightweight and breathable
- Bi-swing Back for mobility and comfort
- Banded crotch for additional mobility when squatting
- Numeric sizing

CUTM-70 VersaPro™ Coat, Tan
CUTM-20 VersaPro™ Coat, Black

Coat Features:

- Sigma twill 7.0 oz/45% meta-aramid/32% Lenzing FR®/17% poly-aramid/6% para-aramid (tan and black)
- Ventilated 3M™ Scotchlite™ II Reflective Material triple trim above hem & cuffs (lime/yellow & silver)
- Bi-swing back for exceptional forward mobility
- 3" overlapping collar for comfortable interface
- Self-fabric cuff reinforcements with hook and loop and Dee-ring adjusters
- Thermoplastic zipper front closure with internal storm flap
- 3.5" x 7" x 2" radio pocket on left chest
- 8" x 8" x 2" semi-bellows pockets, lined all four sides with Kevlar® twill
- 1" x 3" triple layer self-fabric mic tab 2" above radio pocket

PUTM-70 VersaPro™ Pant, Tan
PUTM-20 VersaPro™ Pant, Black

Pant Features:

- Sigma twill 7.0 oz/45% meta-aramid/32% Lenzing FR®/17% poly-aramid/6% para-aramid (tan and black)
- Ventilated 3M™ Scotchlite™ II Reflective Material triple trim above cuffs (lime/yellow & silver)
- Self fabric with 1-layer of Lite-N-Dri™ foam knee reinforcements
- Pants cuffs have self-fabric reinforcements & self-fabric hook & loop and Dee-ring adjusters
- Thermoplastic zipper with hook and loop and snap storm fly closer
- Postman-style take-up straps at waist
- Low-rise contoured waist band
- Zipper leg insert for expandable panel
- 8" x 8" x 2" full bellows pockets on each thigh lined with Kevlar® twill
- Radial inseam band enables free and natural movement

ADDITIONAL OPTIONS:

- BL005 .5" x 3.5" self-fabric belt loops (set of 5) (Tan or Black)
- BELT013 Black Kevlar® belt (Size S-3XL)
- LP1MP 4" x 18" One Line Letter Sewn on (Tan or Black)
- LP1VMP 4" x 18" One Line Letter Patch w/ Velcro
One Line of 3" Sewn on Letters (up to 12 Letters)
Must order a patch for all lettering

Available in the following sizes:

- Coat Chest 32" - 60" (even sizes only)
- Pant Waist 28" - 58" (even sizes only)
- Inseam R (30") or L (32")



***NY State Contract**
Pricing Available -
Call for pricing



Traditional Brush Shirt

CrewBoss™ Traditional Brush Shirt

Based off the original Forest Service style brush shirt, the Traditional Brush Shirt is designed for optimal functionality on the most high pressure fire lines. The Traditional Brush Shirt provides superior personal protection with dependable strength and is lightweight, breathable and inherently flame resistant.

Features:

- Certified to current NFPA 1977 Standards
- Large spade-style pockets with hook and loop closures.
- Forest Service style button-front closure.
- Hook and loop cuff closures insures tight fit at the glove.
- Extra-long square-cut tails.
- Nomex® thread throughout.
- Stress points bartacked at 10 locations.
- Available in sizes S-XL, 2XL - Add 10%, 3XL - Add 15%

WLS0205

6.0 OZ. NOMEX YELLOW

WLS0235

5.8 OZ. TECASAFE PLUS YELLOW



Brush Shirt

CrewBoss™ Brush Shirt

The CrewBoss Brush Shirt builds on the functionality and durability of our Traditional Brush Shirt, with a few key new features to improve performance in the field.

Same Features as above, plus:

- Certified to current NFPA 1977 Standards
- Two large breast pockets with hook and loop closures.
- Shoulder mounted pen pocket
- Full-cut shoulder and body design.
- 30" extra-long, square-cut tails.
- Unique 3" stand-up collar with throat strap.
- Fabric-covered, nickel-plated, snap front closure.
- Available in sizes S-XL, 2XL - Add 10%, 3XL - Add 15%

WLS0105

6.0 OZ. NOMEX YELLOW

WLS0135

5.8 OZ. TECASAFE PLUS YELLOW

CrewBoss™ Classic Brush Pants

For decades wildland firefighters have depended on the quality and comfort of the CrewBoss Brush Pant. Over the years we have made adjustments and added features based on real feedback from the fire line. However, at its heart this is the same classic design that you have always loved.

Features:

- Certified to current NFPA 1977 Standards.
- Elastic back band for ultimate freedom and comfort.
- Seven oversized belt loops to accept 2" web belts.
- Two generous rear pockets.
- Oversized, extra-deep front slash pockets.
- Extra roomy leg and seat cut.
- Original crotch reinforcement panel.
- Unidirectional cargo pockets prevent snagging
- Hook and loop ankle straps covered with Nomex® fabric for heat resistance.
- Brass, self-locking zippered fly with snap closure.
- Nomex thread throughout.
- Stress points bartacked at 38 locations for maximum durability.
- Available in sizes S-XL, 2XL - Add 10%, 3XL - Add 15%



Classic Brush Pants, Spruce Classic Brush Pants, Yellow

WLP0105

6.0 OZ. NOMEX YELLOW

WLP0108

6.0 OZ. NOMEX SPRUCE

WLP0117

7.0 OZ. TECASAFE PLUS YELLOW

WLP0120

7.0 OZ. TECASAFE PLUS SPRUCE

**We carry the full line of CrewBoss™ offerings - check our website for more products!*

11SL - Gerber Response 3 in 1 Parka

starting at

11SL

Waterproof breathable NFPA 1999, 2008 certified Blood Born Pathogen Impervious common chemical resistant StedAIR EMS outer shell. LumenX imprinted reflective accents. ANSI 107 Class 3 for superior visibility with Scotchlite Striping. Four pocket construction with radio pocket, patch pocket and lower cargo pockets. Dual interior

zippers accept a variety of Interchange System Liners.

- ANSI 107:2010 Class 3 High Visibility
- Two tone design Lime Yellow with Navy accents
- Large Lower Cargo Pockets
- Radio Pocket on right chest
- 3M Scotchlite Reflective Stripes
- Elasticized cuffs with adjustment tabs
- Mic tabs on both shoulders
- Hip length



Removable Fleece Liner Jacket

Can be worn separately or zipped into the outer shell jacket for additional warmth.

- 200 Series Polar Fleece
- 2" Lime/ Silver Triple Trim around the chest and waist
- Waist Length
- Slash pockets with Velcro tab closures
- Knit Cuffs

Sizing as follows:

S (36-38) M (40-42) L (44-46) XL (48-50)

Oversizes are available: Please call for pricing.

Coat Options:

- 3 or 4 inch Star of Life on back
- 5 or 7 inch Star of Life on back
- 2" or 3" heat applied letters



Removable liner

40P1 - Gerber 911 Rain Pant

starting at

Waterproof breathable NFPA 1999 certified Blood Born Pathogen Impervious common chemical resistant StedAIR EMS outer shell.

Waterproof breathable rain pants now include a removable quilted liner!

- Double Reinforced Knees and large cargo pockets
- Elasticized drawstring cord with barrel clip adjusters
- Zippered cuffs for easy on and off
- Scotchlite around the calf –Silver or Lime/ Silver Triple Trim
- Only Available in Regular (28") or Long (32") Inseam
- *****No Custom Inseam lengths*****

Waist Sizes Available:

S (28-32) M (32-36) L (36-40) XL (40-44)

Oversizes are available: Please call for pricing.

*Must specify trim color - Silver or Lime/Silver Triple Trim



40L1

Portwest Public Safety Vest

US387YRE Fire Yellow/Red
US387YBR Police Yellow/Black

- 2" silver reflective tape with contrast material
- Black lettering "FIRE" or "POLICE" on back
- Cooling mesh fabric
- Pockets: 2 internal lower patch, 1 radio
- Dual ID holder
- 5 point breakaway, side and shoulder seams, center front
- 2 mic tabs
- 100% Polyester Mesh, 3oz
- Yellow/Red or Yellow/Black
- Call for pricing of custom lettering
- Available in the following sizes:
 M/XL or 2XL/4XL



Petra Roc Expandable Breakaway Public Safety Vest, with Clear Panel Pocket

LVM2-PSVP (w/panel)
LVM2-PSV (w/o panel)

ANSI/ISEA 107 Class II & 207-2006 Standards

- Lime Mesh / Orange Binding / (PVC Title Panel Pocket)
- 5 point break away with velcro closures & hook & loop adjustable sides
- Front Zipper Closure
- 2" certified tapes with 4" contrasting color stripes
- Two nylon microphone tabs
- 6 Pockets
 - (1) Cell phone pocket
 - (1) Clear badge/ID pocket
 - (1) 3-division pocket
 - (2) Bottom inside pockets 7"W x 7"H
 - PSVP has clear PVC pocket 10"W x 5"H on upper back for insert
- PVC-REF-LY94 Lime/Yellow Reflective PVC 4"x9" Title Panel
- Available in the following sizes:
 - Regular, Fits S-XL (40"-52")
 - Plus, Fits 2X-5X (52"-64")
 - Super, Fits 6X-8X (64"-80")



LVM2-PSV

POLICE

LVM2-PSVP
 Stock Reflective Insert

Stock Titles Available: ASST CHIEF, CHIEF, COMMAND, CRIME SCENE, EMS, FIRE, FIRE DEPT, FIRE-RESCUE, FIRE POLICE, HAZMAT, INCIDENT COMMAND, INFORMATION, POLICE, REHAB, RESCUE, SAFETY, SECURITY, SHERIFF, SUPERVISOR (Custom Titles - Call for pricing)

Game Sportswear 5-Point Breakaway Mesh Vest I-684

Lightweight mesh polyester keeps you cool.

Features

- Meets ANSI/ISEA 107-2015 Class 2 color standards
- 2" silver/grey reflective tape with 1" contrast color stripes on sides of reflective tape
- 100% lightweight mesh polyester
- Velcro® breakaway closures on shoulders, sides and front
- Fully dielectric, non-conductive, zipper closures with Velcro®
- Right chest radio pocket
- Three pen pocket holder on left sleeve
- Imported
- Customizations are available on twelve (12) or more pieces.

Sizes: S-5XL
 Color: Neon Lime



030 - FLUORESCENT YELLOW WITH SILVER/GREY REFLECTIVE TAPE BORDERED WITH 1" FLUORESCENT ORANGE STRIPES



I-684

For Fire Police Accessories,
 see pages 62-63

70F3/L - Gerber Typhoon Rain Coat, Black/Lime

starting at

- Supple Waterproof Breathable Taslan Outer Shell
- Brushed Polyester ANSI 107 Compliant lining
- ANSI 107:2010 Class 3 High Visibility
- Full Length Reversible Design – 48”
- Storm Flap and Zipper Front Closure
- Elasticized adjustable cuffs
- Stand Up Storm Collar
- Concealable Drop In Hood w/ barrel clips and visor
- Set in pockets on the front panels inside and out
- Pass through side equipment access
- Mic Tabs on the shoulders inside and out



70F3/L

70W3/L - Gerber Typhoon Rain Jacket, Black/Lime

starting at

Features as above, except:

- Hip Length Reversible Design – 32”
- Zippered side equipment access

70W3/L



Chest Sizes Available:

- S (36-38)
- M (40-42)
- L (44-46)
- XL (48-50)

Oversizes are available: Please call for pricing.

70RXL - Gerber Eclipse SX Jacket, Lime Yellow

starting at

Waterproof breathable ANSI 107:2010 Class 3 compliant jacket. Lime-yellow waist length jacket with black edge reflective trim.

- BioTex Blood Born Pathogen Resistant Barrier ASTM F 1671
- Reflective LumenX accent material
- Warrior Soft Shell Liner can be worn separately or zipped in
- Two way cargo pockets with fleece hand warmers
- Mic Tabs on both shoulders
- Waterproof zippered pockets on both sides of chest
- Waist length with extended tail
- Concealable hood



70RXL

Chest Sizes Available:

- S (36-38)
- M (40-42)
- L (44-46)
- XL (48-50)

Oversizes are available: Please call for pricing.

Coat Options:

- 3 or 4 inch Star of Life on back
- 5 or 7 inch Star of Life on back
- 2" or 3" heat applied letters



Warrior Soft Shell Liner

71EXL - Gerber Extreme XT Parka

starting at

- Waterproof / Breathable Outer Shell w/ Stretch
- BioFlex Blood Borne Pathogen Resistant Barrier ASTM F1671
- Two tone design Lime Yellow with Navy accents
- ANSI 107:2010 Class 3 High Visibility
- 2" Silver Scotchlite striping with 1/4" black edging
- Spacious cross draw Napoleon set-in chest pockets
- Zipper closure radio pockets on both upper chests
- Concealable hood
- Two way cargo pockets
- Two way patch pockets with flap closures
- Mic tabs on both shoulders
- Dual Interior Interchange zippers to attach various Interchange Liners

Chest Sizes Available:

S (36-38) M (40-42) L (44-46) XL (48-50)
Oversizes are available: Please call for pricing.

Extreme XT Parka



51EL Gerber Sigma Soft Shell Liner Jacket

starting at

- Waterproof Breathable Soft Shell w/ crushed fleece backing
- BioTex Blood Borne Pathogen Resistant Barrier ASTM F16
- ANSI 107 Class 3 High Visibility
- Scotchlite Reflective Striping
- Adjustable cuffs with elastic
- Zippered hand pockets & Zippered interior pockets
- Segmented mic strips on shoulders
- Interchange Front Zipper - Zips into the Extreme Parka

Chest Sizes Available:

S (36-38) M (40-42) L (44-46) XL (48-50)
Oversizes are available: Please call for pricing.

Coat Options:

- 3 or 4 inch Star of Life on back
- 5 or 7 inch Star of Life on back
- 2" or 3" heat applied letters

Sigma Soft Shell
Navy/Lime



***Other Gerber styles available on
our website at:
www.fire-end.com**

PORTWEST HI-VIS CLASSIC BOMBER JACKET UC466

ANSI/ISEA 107-2015 TYPE R CLASS 3 & ANSI/ISEA 107-2010
Class 3:2

Made with tough 300 Denier 100% polyester yarn. This is a tough fabric for tough conditions. 300D fabric has superb abrasion and tear resistance. The polyurethane (PU) coating on the inside makes the fabric durable and waterproof, and the outer has a water and stain repellent coating which helps to keep the garment clean.

Standard features

- 2" Silver reflective tape
- Pack away ergonomically shaped detachable hood
- Detachable sleeves
- Fur liner and collar
- Elasticized waistband and cuffs
- Stormflap with zipper and snap closure
- Waterproof with sealed seams • 7 Pockets
- Available in: Yellow/Black or Orange/Black

Sizes Available:

M (40-41") L (42-44") XL (46-48")
2XL (50-52") 3XL (54-55") 4XL (56-58")
5XL (60-64")

**Call for lettering*



UC466



PORTWEST CONTRAST BIB AND BRACE, S489 Lined S488 Unlined

ANSI/ISEA 107-2015 CLASS E & ANSI/ISEA 107-2010 Class 2:2

Standard features:

- 2" Silver reflective tape
- Front zipper fly opening
- Side waist button expansion
- Adjustable straps with durable buckle closure
- Waterproof with sealed seams
- Contrast panel for protection against dirt
- Color: Yellow/Navy

Sizes Available:

S (36-38") M (40-41") L (42-44")
XL (46-48") 2XL (50-52") 3XL (54-55")



S489

PORTWEST HI-VIS 5-in-1 EXECUTIVE JACKET US768

5 Ways to Wear this Garment!

1. Outer Jacket
2. Outer Jacket with Inner Jacket
3. Inner Jacket
4. Outer Jacket with Bodywarmer Vest
5. Bodywarmer Vest (Inner Jacket with sleeves removed)

Standard features

- 2" Silver reflective tape
- Contrast panel for protection against dirt
- Pack away ergonomically shaped detachable hood
- Adjustable cuffs
- Print access for garment customization
- Waterproof with sealed seams
- 9 Outer and Inner Pockets
- Available in:

Yellow/Navy S-4XL
 Yellow/Black S-6XL
 Orange/Navy S-6XL



US768

ANSI/ISEA 107-2015 TYPE R CLASS 3
 EN ISO 20471 CLASS 3
 EN 343 CLASS 3:1

Sizes Available:

M (40-41") L (42-44") XL (46-48")
 2XL (50-52") 3XL (54-55") 4XL (56-58")
 5XL (60-64") 6XL(65-67") *Call for lettering

PORTWEST HI-VIS 7-in-1 TRAFFIC JACKET US427

7 Ways to Wear this Garment!

1. Outer Jacket
2. Outer Jacket with Inner Jacket
3. Inner Jacket
4. Inner Jacket Reversed
5. Outer Jacket with Bodywarmer Vest
6. Bodywarmer Vest (Inner Jacket with sleeves removed)
7. Bodywarmer Vest Reversed (Inner Jacket with sleeves removed)

Standard features

- 2" Silver reflective tape
- Pack away ergonomically shaped detachable hood
- ID card holder window
- Adjustable cuffs
- Mic tab
- Badge holder
- Print access for garment customization
- Waterproof and breathable with sealed seams
- 11 Outer and Inner Pockets
- Available in Yellow

Sizes Available:

M (40-41") L (42-44") XL (46-48")
 2XL (50-52") 3XL (54-55") 4XL (56-58")
 5XL (60-64") *Call for lettering



US427

ANSI/ISEA 107-2015 TYPE R CLASS 3
 EN ISO 20471 CLASS 3
 EN 343 CLASS 3:3



GAME SPORTSWEAR The Black Bottom Parka 1865E

- Meets ANSI/ISEA 107-2015 Class 3 Color Standards
 - 2" silver/grey reflective tape
 - 100% Polyester 300 Denier Oxford PU Coated Heavy Duty Fabric w/ black quilted polyester lining
 - Sealed seams for wind and waterproofing
 - Black bottom to reduce staining on front only
 - Two front pockets w/ storm flaps
 - Machine Washable
 - Velcro® closures on cuffs for adjustable sleeve length
 - Imported
- Neon Yellow
Sizes: S-5XL



GAME SPORTSWEAR The Rescue Jacket 3555

Maximum performance & comfort for first responders.

Outer Jacket Features:

- All-weather, 3-in-1 high visibility jacket
- Meets ANSI/ISEA 107-2015 Class 2 standards
- 1" silver/reflective tape
- Hand-Warmer pockets and inside mesh pocket
- 100% polyester PU coated breathable fabric
- Left chest zippered storage pocket w/ radio pocket
- Right chest zippered storage pocket
- Fleece-lined collar/detachable peaked hood
- Two front pockets with storm flaps
- Two inside pockets / Velcro® ID panel on right chest
- Abrasion panels on shoulders

Inner Jacket Features:

- 100% polyester polar fleece with Taslan nylon accents
- Unlined/mid-hip length
- Left/Right chest storage pockets
- Open bottom hem with adjustable bungee drawstring
- Machine washable
- Imported

Available in your choice of Navy, Red, or Royal

Sizes: S-5XL



*Customizations are available on twelve (12) or more pieces.
We can embroider, letter, apply patches, or custom design.
Please call us at 800-759-3473 to discuss your needs.*

GAME SPORTSWEAR Iconic Quilted Chore Jacket 1250

Ready to take on the tough jobs.

- Wind resistant nylon Tafetta shell
- 5oz. poly-fill lining with thermal knit backing
- 100% polyester rib knit collar, cuff and shoulder gussets
- Full front zipper
- 2 outer pockets
- Inset sleeves with gussets for comfortability
- Tailored bottom hem
- Machine washable
- Imported

Available in your choice of Black or Navy

Sizes: S-5XL



GAME SPORTSWEAR The Firefighter's Work Shirt 810

Comfortable, Durable Denim Collar/Elbow Patches

- 12 oz 95/5 cotton/polyester super weight fleece
- Get a Sure-Fit with a generous cut, allowing for shrinkage after washing (Navy Only)
- No-Curl™ denim collar and elbow patches
- Brass Zipper
- Set-in sleeves/Knit cuffs and bottom band
- NEW Fully redesigned Modern Fit (Navy Only)
- NEW Redesigned Modern Denim elbow patches (Navy Only)
- NEW Cotton Twill tape at collar for strength and comfort (Navy Only)
- NEW Right chest Canvas Twill Radio pocket has 9" depth with Velcro closure and East-Access hidden cell pocket (Navy Only)
- Machine washable • Made in the USA

Navy

Sizes: M-5XL



GAME SPORTSWEAR The Firefighter's Work Shirt without Denim 811

- 12 oz 80/20 cotton/polyester super weight fleece
- Get a Sure-Fit with a generous cut, allowing for shrinkage after washing
- Brass Zip turtleneck with hang loop
- Self-material lay down collar with hang loop
- Set-in sleeves/Knit cuffs and bottom band
- NEW Deep mic clips on shoulders with matching Canvas Twill Accent
- NEW Right chest Canvas Twill radio pocket w/ Velcro Closure & Easy Access hidden cell phone pocket
- NEW Recessed two pen pocket holder on left sleeve for a sleeker look w/ Canvas Twill Accent
- NEW Cotton Canvas Twill tape at the collar. Adds strength and comfort
- Deep Side Seam Pockets
- Machine Washable

Available in your choice of Black, Grey, or Navy

Sizes: S-5XL





Bravo Shirt, NFPA 1975 Compliant*

Seven-button dress front placket has professional appearance. Provides stability even after multiple washings. Fully cured for permanent press and easy to maintain. Five sewn-in military creases for high-quality appearance with minimum maintenance. Includes shoulder epaulets, box-pleated breast pockets (left pocket has pen slot on flap), interior badge sling holder and fuse banded dress collar.

Available in 4.5 oz. Nomex IIIA, 5.8 oz. Tecasafe and 4.5 oz. Poly/Cotton

Male	No.	Nomex	No.	Tecasafe	No.	*Poly/Cotton
LS Navy Blue	0215-10		1380-10		1276-20	
SS Navy Blue	0515-10		1480-10		1576-20	
LS Med Blue	1283-00		N/A	N/A	1272-20	
SS Med Blue	1583-00		N/A	N/A	1572-20	
LS White	N/A	N/A	N/A	N/A	1271-10	
SS White	N/A	N/A	N/A	N/A	1571-10	

* Poly/Cotton is not NFPA compliant.



Bravo Shirt 100% NFPA Certified Cotton Twill, NFPA 1975 Compliant*

Seven-button dress front placket has professional appearance. Provides stability even after multiple washings. Fully cured for permanent press and easy to maintain. Five sewn-in military creases for high-quality appearance with minimum maintenance. Includes shoulder epaulets, box-pleated breast pockets (left pocket has pen slot on flap), interior badge sling holder and fuse banded dress collar.

	Long Sleeve	Short Sleeve
Navy	0227NV-20	0527NV-20
Med Blue	0227MB-00	0527MB-00
White	0227WH-00	0527WH-00



Deluxe Uniform Trouser, NFPA 1975 Compliant*

No roll waistband, left and right front swing type pockets, two welt style hip pockets, top stitched side seam, heavy duty zipper. Available in Nomex IIIA Gabardine (G), 7.5 oz. Nomex IIIA Plain Weave (P), 7.0 oz. Flamex II, 7.0oz. Tecasafe, 4.5oz. Poly/Cotton and 100% Cotton.

Male/Mid Blue	No.	Nomex/G	No.	Nomex/P	No.	Tecasafe
	2106-40		2101A-20			2180-30
Male/Mid Blue	No.	Poly/Cotton*	No.	100% Cotton		
	0130-30		0150NV-10			

* Poly/Cotton is not NFPA compliant.



BDU Attack Pants, NFPA 1975 Compliant*

- 7.75 oz/yd² 100% cotton twill.
- Fade-resistant finish – up to 25 home launderings without fading.
- Side adjusters at the waist for custom fit.
- Reinforced quarter-top front pockets, triple-bellows leg pockets & rear welt pockets with flaps.
- Reinforced knees and seat.
- Removable drawstring at cuffs.
- Waist Sizes 38-40 (even only)
- (Available in Short-31", Regular-33" and Long-35" inseams)

Unisex	No.	Cotton
Navy Blue	BDU235-30	



*The full line of LION Stationwear is available - Call for info/pricing



EMS Flat Front Shorts, NFPA 1975 Compliant*

0148FPKT-10

- 7.75 oz/yd² 100% cotton twill - Navy
- Fade resistant – up to 25 home launderings without fading.
- EMS pocket on the right leg with scissors straps.
- Semi-bellows pocket with hook and loop closure on the left leg.
- Double-layered reinforced front pockets.
- Ratcheting zipper closure with one button closure at waistband.
- 11" inseam on flat front.
- Waist Sizes 28-38, 40-50 (even only)



Job Shirt

LJB11-10

- 80% cotton/20% polyester, 9.3oz/yd² fleece - Navy
- Treated with a Pre-Cure Treatment to reduce the amount of shrinkage when washed repeatedly
- Fleece fabric provides easy care – just machine wash, tumble dry
- Lightweight warmth and breathability for optimum comfort
- 100% cotton ripstop reinforced elbows
- Handwarmer pockets and a chest pocket with hook and loop closure, & an opening for a pen
- D-Ring for key attachment
- 1/4 zip opening makes donning and doffing easy
- Embroidery can be ordered/applied - Call for pricing
- Unisex S-5XL



Action Line Jacket

Comfortable, affordable station jackets that offer high-quality design, easy care and extended wear life — while also providing a professional image.

3432-40

Action Line Jacket

0794-40

Liner for Action Line Jacket

JACKET FEATURES:

- 65% polyester/35% cotton blend - Navy
- Treated with a pre-cure treatment to reduce the amount of shrinkage when washed repeatedly
- Bi-swing back for outstanding mobility
- Hidden front pockets
- Embroidery can be ordered/applied
- Optional badge tab and quilted long-sleeved zip-in liner
- Unisex XS-4XL

OPTIONAL LINER FEATURES:

- 100% quilted polyester - Black
- Arm/body button application to secure fit with Action Line Jacket
- Right side pocket for additional storage



Stop / Slow Paddles

18018-SS-NS 18" Aluminum Stop / Slow Paddle, Non Reflective

18018-SS-EG 18" Aluminum Stop / Slow Paddle, Engineer Grade Reflective

TrafFix Stop/Slow Paddles are made from strong, non-corrosive material without any sharp edges. The paddle measures 18" x 18" and features a 1¼" diameter hardwood handle. Available in reflective and non-reflective surfaces.



Hi-Viz Traffic Control Gloves Ringers Model 307

- Bright, highly visible color
- Reflective strips on palm
- Quick pull-on design
- Great flexibility
- Ideal for traffic control, Fire Police, general purpose construction, & industrial safety.
- Sizes S-2XL



Peak View Plus Hard Hat PV64

ANSI Z89.1 TYPE II CLASS G

- Portwest exclusive design and patented model
- Translucent shell to see through peak and sides
- Extra strong yet ultra light weight Polycarbonate shell
- UV 400 stabilised
- 6 points textile harness, adjustable size
- Non-Vented version
- Buckle size adjustment for easy fitting
- Type II Hard hats are designed to withstand impacts from the top and side.

Available colors: Smoke - Blue - Clear - Yellow - Green - Red - Orange - Pink



R&B Flare Container SAC-FC-30

Keep your flares handy, dry, and damage free. Holds twelve 30-minute flares. Small enough to store anywhere and includes a handle. Molded from durable plastic that resists the wear and tear of tough use. Color: Red. Wt. 7 oz.



Retracta-Cade Crowd Control Barrier

CROWD CONTROL WHERE & WHEN YOU NEED IT

The Retracta-Cade is proudly made in the USA

- Heavy-duty 37 lbs. barrier provides immediate security
- Retracts easily for easy storage and transport

Call for more info & pricing



Nightstick LED Traffic Wand

Features a bright lumen output with a cone and a black formed handle for ultimate grip and comfort. The lightweight Nightstick LED Traffic Wands are ideal for daylight or overcast applications and are the perfect choice for air ground crews, directing traffic, or marking a potentially hazardous area.

- Bright yellow/red light for daylight or night use
- Single push button switch located on body for all modes
- IP-X7 Waterproof
- Powered by 3 AAA batteries (included)
- On/Strobe/Off functionality
- Lightweight for long use
- Impact & chemical resistant
- 1 Year Limited Warranty

- NSP-1632** LED Traffic Wand - Red
- NSP-1634** LED Traffic Wand - Yellow



Nightstick Safety Light / Flashlight

- All LED construction
- Has both a tight-beam long-throw flashlight and a wide-angle two colored flashing safety light array
- Lighting modes: momentary and constant-on flashlight, full-power safety light, alternating color flashing safety light & dual-light (both the flashlight & safety light array at the same time)
- All LEDs have a 35,000 hour life
- Light weight and durable
- Impact, chemical and moisture resistant
- Two button design top: flashlight, bottom: safety light
- Oval shape with textured body and soft-touch finish
- 4 AA batteries (included)

•Optional 1260Y/R - Fits over the flashlight/spotlight and turns it into a safety light for a multitude of uses including traffic direction and roadside hazards. Ideal for night time use.

- NSP-1170** Alternating Red/Blue Floodlight & White Flashlight
- 1260-YCONE** Yellow Cone for NSP1170
- 1260-RCONE** Red Cone for NSP1170

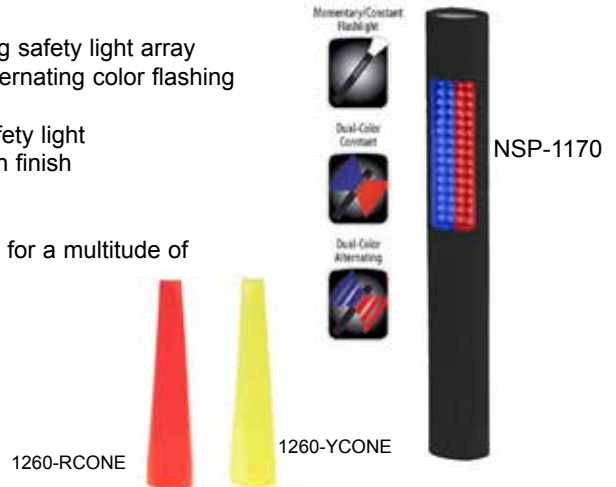

LED Baton Road Flare

A multi-functional flare that can be a road flare or a safety wand. Strong enough to withstand heavy truck traffic yet light enough to hold easily in your hand to direct traffic.

- 15 red LEDs visible light range up to 4 miles (effectively see light patterns up to 1 mile)
- 1 Half-watt flashlight
- Corrosion proof
- Rechargeable battery included, does not need to be replaced
- 5 Flash patterns including S.O.S. Morse Code
- Includes 120V wall charger, 12V car charger, USB charger
- MADE IN USA
- Waterproof to 50 feet
- Crush proof
- High strength magnets attach to metal surfaces

- 1154** Single Yellow
- 1155** Single Red
- 1156** Single Blue



28" Safety Cone - Collapsible Kit 5-Pack

1193

28" collapsible safety cone kit is compact and stores easily in a car trunk, utility truck, or tool box. Set of 5 cones included in kit.

- Collapses flat for easy storage
- 2 ½ lb. weighted base
- Blinking red LED beacon
- Meets MUTCD specifications (4" & 6" reflective bands)
- Meets NFPA 1901 Standards; Section 6.7.3 Miscellaneous Equipment
- Requires 2 AAA batteries (included)
- Made of durable nylon
- 2 Reflective stripes
- Includes the storage case





**Mustang Ice Commander
Rescue Suit**

IC9001 03



**RNR Signature Series
Water Economy Drysuit**

RSDS-NB



NRS Workboot Wetshoes

2338



Kent First Responder Vest

1514



Kent Swift Water Rescue Vest

1513



Kent Mesh SAR Vest

1510

We carry a full line of Water Rescue Equipment
Call or Email for Information and Prices



We carry a full line of rescue and utility ropes, sold by the foot and preset lengths



We carry a full line of Rock-N-Rescue Equipment

Technical Rescue Equipment -

Fire, EMS, Search & Rescue, Water, Rope

****Call for pricing***



SIMULAIDS, Rescue Randy
Combat Challenge 6' 1" - 165 lbs.
1435



R-N-R, Grand Rope Bag
RPB



NRS, Havoc Helmet
426045-R/Y



Crosby Hook
S-360



STERLING, Tech
Extension Lanyard
SCS90APLY0X



Omega Pacific, NFPA
Small Aluminum
Locking D Carabiner
BINER2



1" Tubular Nylon
Webbing
060101



35R (AA135) - Rocker Lug Double Swivel Female

F E M A L E	FEMALE										
		1.5"	2.0"	2.5"	3.0"	3.5"	4.0"	4.5"	5.0"	6.0"	
	1.5"										
	2.0"										
	2.5"										
	3.0"										
	3.5"										
	4.0"										
	4.5"										
	5.0"										
6.0"											



57L (AA157) Long Handle Double Swivel Female

F E M A L E	FEMALE										
					2.5"	3.0"	3.5"	4.0"	4.5"	5.0"	6.0"
	2.5"										
	3.0"										
	3.5"										
	4.0"										
	4.5"										
5.0"											
6.0"											



36R (AA136) Rocker Lug Double Male

M A L E	MALE										
		1.0"	1.5"	2.0"	2.5"	3.0"	3.5"	4.0"	4.5"	5.0"	6.0"
	.75"										
	1.0"										
	1.5"										
	2.0"										
	2.5"										
	3.0"										
	3.5"										
	4.0"										
	4.5"										
5.0"											
6.0"											

Please call for special thread and color pricing

THREADED ADAPTERS



37R (AA137) Rigid Rocker Lug Female to Male

F E M A L E	MALE										
	.75"	1.0"	1.5"	2.0"	2.5"	3.0"	3.5"	4.0"	4.5"	5.0"	6.0"
.75"											
1.0"											
1.5"											
2.0"											
2.5"											
3.0"											
3.5"											
4.0"											
4.5"											
5.0"											
6.0"											



54R (AA154RL) Rocker Lug Swivel Female to Male

F E M A L E	MALE											
				1.5"	2.0"	2.5"	3.0"	3.5"	4.0"	4.5"	5.0"	6.0"
1.5"												
2.0"												
2.5"												
3.0"												
3.5"												
4.0"												
4.5"												
5.0"												
6.0"												



53R (AA153RL) Rocker Lug Swivel Female to Rocker Lug Rigid Female

(For AA153 Long Handle Swivel, call for pricing)

S W I V E L	FEMALE											
				1.5"	2.0"	2.5"	3.0"	3.5"	4.0"	4.5"	5.0"	6.0"
1.5"												
2.0"												
2.5"												
3.0"												
3.5"												
4.0"												
4.5"												
5.0"												
6.0"												

Please call for special thread and color pricing



54L (AA154) Long Handle Swivel Female to Male

S W I V E L	MALE										
	Size			2.5"	3.0"	3.5"	4.0"	4.5"	5.0"	6.0"	
	2.5"										
	3.0"										
	3.5"	PLEASE CALL FOR PRICING									
	4.0"										
	4.5"										
	5.0"										
6.0"											



56L (AA156) Rigid Long Handle Female to Male

F E M A L E	MALE										
	Size			2.5"	3.0"	3.5"	4.0"	4.5"	5.0"	6.0"	
	2.5"										
	3.0"										
	3.5"	PLEASE CALL FOR PRICING									
	4.0"										
	4.5"										
	5.0"										
6.0"											

Please call for special thread and color pricing





**S37S (HSFR) Storz to Rocker Lug Female Rigid Thread
4", 5" and 6" Storz with Locks**

STORZ	FEMALE								
		2.5"	3.0"	3.5"	4.0"	4.5"	5.0"	6.0"	
	2.5"								
	3.0"								
	4.0"	PLEASE CALL FOR PRICING							
	5.0"								
6.0"									

**S54R (HSFS) Storz to Rocker Lug Female Swivel Thread
4", 5" and 6" Storz with Locks**



STORZ	FEMALE								
		2.5"	3.0"	3.5"	4.0"	4.5"	5.0"	6.0"	
	2.5"								
	3.0"								
	4.0"	PLEASE CALL FOR PRICING							
	5.0"								
6.0"									

**S54L (HSFS-LH) Storz to Long Handle Female Swivel Thread
4", 5" and 6" Storz with Locks**



STORZ	FEMALE								
		2.5"	3.0"	3.5"	4.0"	4.5"	5.0"	6.0"	
	2.5"								
	3.0"								
	4.0"	PLEASE CALL FOR PRICING							
	5.0"								
6.0"									

**S36S (HSMR) Storz to Male Rigid Thread
4", 5" and 6" Storz with Locks**



STORZ	MALE								
		2.5"	3.0"	3.5"	4.0"	4.5"	5.0"	6.0"	
	2.5"								
	3.0"								
	4.0"	PLEASE CALL FOR PRICING							
	5.0"								
6.0"									

*Due to the volatility in the market, our pricing is, unfortunately, subject to change without notice. Please check our website or call us for the most up to date pricing.

Please call for special thread and color pricing

S60S (HSTS) Storz to Storz 4", 5" and 6" Storz with Locks



S T O R Z	Size	2.5"	3.0"	4.0"	5.0"	6.0"
	2.5"					
	3.0"					
	4.0"	PLEASE CALL FOR PRICING				
	5.0"					
	6.0"					

CAPS

Threaded Caps



Part #	Size	NST Rocker Lug (2) w/o Chain		NST Long Handle (1) w/o Chain	
CC605	6.0"				
CC505	5.0"				
CC455	4.5"				
CC405	4.0"				
CC355	3.5"	PLEASE CALL FOR PRICING			
CC305	3.0"				
CC255	2.5"				
CC205	2.0"				
CC155	1.5"				
CC105	1.0"				

***WITH CHAIN - Call for pricing**

**Caps Ordering Example: CC1552 = 1.5" Cap NST Rocker Lug
CC5051 = 5.0" Cap NST Long Handle**

Storz Caps with Chain (HBC)



Part #	Size		High Pressure with Pentagon Head		
			Part #	Size	
CC607	6.0"				
CC507	5.0"		CC507-008	5.0"	
CC407	4.0"		CC407-008	4.0"	
CC307	3.0"		*Call for pricing on hydrant to storz adapters		
CC257	2.5"				



*Due to the volatility in the market, our pricing is, unfortunately, subject to change without notice. Please check our website or call us for the most up to date pricing.

Please call for special thread and color pricing



Threaded Plugs

NST Rocker Lug

Part #	Size	w/o Chain	
PL6052	6.0"		
PL5052	5.0"		
PL4552	4.5"		
PL4052	4.0"		
PL3552	3.5"		
PL3052	3.0"		
PL2552	2.5"		
PL2052	2.0"		
PL1552	1.5"		
PL1502	1.0"		

***WITH CHAIN**

PLEASE CALL FOR PRICING

MOUNTING PLATES

Threaded Mounting Plates



		MALE		FEMALE	
Part #	Size				
M 60	6.0"				
M 50	5.0"				
M 45	4.5"				
M 40	4.0"				
M 30	3.0"				
M 25	2.5"				
M 15	1.5"				
M10	1.0"				

Add M for male and E for female
Ordering Example: MM60 = 6.0" Male Mounting Plate
MF60 = 6.0" Female Mounting Plate

PLEASE CALL FOR PRICING

Storz Mounting Plates

Part #	Size		
MF407/HSMB-40	4.0"		
MF507/HSMB-50	5.0"		



Please call for special thread and color pricing

*Due to the volatility in the market, our pricing is, unfortunately, subject to change without notice. Please check our website or call us for the most up to date pricing.

KE-30 (H30E/AE) 30° Elbow Rocker Lug Swivel Female to Male Threads



H30E



AE

Size
2.5" (H30E25)
3.0" (H30E30)
3.5" (AE3535)
4.0" (AE4040)
4.5" (AE4545)
5.0" (AE5050)
6.0" (AE6060)

PLEASE CALL FOR PRICING

For Long Handle Swivels - Call for pricing and specify on your order.

SKE - 30° (H30E) Elbow Rocker Lug Swivel Female to Storz



H30E

4", 5" and 6"
Storz with Locks
K-Coat Aluminum

		FEMALE SWIVEL						
		2.5"	3.0"	3.5"	4.0"	4.5"	5.0"	6.0"
S T O R Z	2.5"							
	3.0"							
	4.0"							
	5.0"							
	6.0"							
	For Long Handle Swivels - Call for pricing and specify on your order.							

PLEASE CALL FOR PRICING



KEP - Suction Elbow
Rocker Lug Swivel Female to Male
Available 45° or 90°
K-Coat Aluminum

		MALE						
		2.5"	3.0"	3.5"	4.0"	4.5"	5.0"	6.0"
F E M A L E	2.5"							
	3.0"							
	3.5"							
	4.0"							
	4.5"							
	5.0"							
	6.0"							
Please specify 45° or 90° when ordering.								

PLEASE CALL FOR PRICING

*Due to the volatility in the market, our pricing is, unfortunately, subject to change without notice. Please check our website or call us for the most up to date pricing.

Please call for special thread and color pricing

Self Leveling Floating Strainer

- Increased flow rates due to high intake ratio
- Maximum pump flows
- Lightweight design
- NEW compact design for easy storage
- Available with Storz & Camlock connections



Part #	Size	NST -0	Storz -7	Camlock -4
FBS60	6.0"			
FBS50	5.0"			
FBS45	4.5"			
FBS40	4.0"			
FBS30	3.0"			
FBS25	2.5"			
FBS15	1.5"			
FSMB___ Mounting Bracket 4" thru 6" - Call for pricing Ordering Example: FS507 = 5.0" Storz				

Low Level Strainer

- Includes Internal screen
- Shown with optional external screen
- Drafts to within 2"
- Compact design
- Pivoting neck
- Jet Siphon included on 4" through 6"
- K-Coat for long life



Part #	Size	NST -0	Storz -7	Camlock -4
LL60	6.0"			
LL50	5.0"			
LL45	4.5"			
LL40	4.0"			
LL30	3.0"			
LL25	2.5"			
LLMB Mounting Bracket - Call for pricing Comes w/Internal Screen Ordering Example: LL60 = 6.0" NST				

Box Strainer

- Ideal for streams
- Heavy Duty screen
- Two eye hooks on top
- K-Brite finish



Part #	Size	NST -0	Storz -7	Camlock -4
BX60	6.0"			
BX50	5.0"			
BX45	4.5"			
BX40	4.0"			
BX30	3.0"			
BX25	2.5"			
BX15	1.5"			
Ordering Example: BX500 = 5.0" NST				

Basement Strainer



Part #	Size	NST -0	Storz -7	Camlock -4
BL40	4.0"			
BL30	3.0"			
BL25	2.5"			
Ordering Example: BL250 = 2.5" NST				

Barrel Strainer

- Ideal for marine applications
- Lightweight
- Full flow
- K-Brite or K-Chrome



Part #	Size	NST -U	Storz -7	Camlock -4
BS60	6.0"			
BS50	5.0"			
BS45	4.5"			
BS40	4.0"			
BS30	3.0"			
BS25	2.5"			
Ordering Example: BS60C = 6.0" Chrome NST				

*Due to the volatility in the market, our pricing is, unfortunately, subject to change without notice. Please check our website or call us for the most up to date pricing.

Please call for special thread and color pricing

7982 AKRON REVOLUTION™ INTAKE VALVE w/ 30 Degree Swivel Elbow Inlet

The compact design saves valuable space on your pump panel. The EVOLUTIONARY handwheel blends in with the body and will not obstruct surrounding equipment on the pump panel. It is also easy to grab and adjust, providing simple and easy operator control. Utilizing a ball sector for controlling water flow, the Revolution is reliable and robust providing years of hassle free operation.

- Swiveling intake elbow with locking pin (30° inlet)
- Robust, integrated Pyrolite patent-pending handwheel for easy operation
- Critical pump side waterway components constructed of non-corrosive stainless steel
- Durable, powder coated interior and exterior finish
- Field adjustable relief valve between 50-250 psi (requires 7/8" wrench to adjust).
- Includes 1 1/2" NPT female thread
- Quick turn Bleeder valve operation - vents into relief discharge
- Built-in Open/Close position indicator on top of valve
- 2000 gpm max flow
- All parts that stay in contact with water are constructed of stainless steel
- Field serviceable design

7983 Akron Revolution™ Intake Valve (Straight Inlet)

Optional Items for 7982 & 7983:

- 4", 5" and 6" Storz Cap and Chain
- 4" or 5" Full-Time Swivel Storz Inlet
- 6" Storz Inlet

7980 AKRON BLACK MAX PISTON INTAKE VALVE

Corrosion resistant stainless steel and poly-impregnated aluminum are combined for a durable Piston Intake Valve. A large unique oval waterway increases efficiency while reducing the overall size. All this, plus a special 10 year warranty against corrosion makes the Black Max piston intake valves the obvious choice for today's fire service.

- Stainless steel piston housing
- Compact size - Extends only 11 15/16" from the pump panel
- 250 psi operating pressure
- Polymer Piston for improved corrosion resistance
- Large waterway with a cast-in turning vane for reduced turbulence and efficient flow
- Pressure relief valve adjustable from 50 - 250 psi (preset @ 150 psi)
- 53° elbow
- 3/4" air bleeder valve

Optional Items:

- 4", 5" and 6" Storz Cap and Chain
- 4" or 5" Full-Time Swivel Storz Inlet
- 6" Storz Inlet
- Air Bleeder Diversion Hoses

Harrington H1000 Ball Intake Valve

A low profile, 12" depth ball intake valve designed for pumper intake control. Valve meets 900 PSI hydrostatic strength test. Utilizes full flow ball valve design, and has an easy to see visual indicator of ball position. Includes a 3/4" air bleeder valve, an integrated 30-degree elbow, and a 250 PSI field adjustable pressure relief valve (adjustable in increments of 25 degrees from 75- 250 PSI). Friction loss at 1000 GPM: 0.1 PSI. 12" x W. 8" x Ht 16" Wt. 34 lb.

- | | |
|--------------------------------------|---------------|
| 4" Storz to 4 1/2" NST Female Swivel | H1000-40-45NH |
| 4" Storz to 5" NST Female Swivel | H1000-40-50NH |
| 4" Storz to 6" NST Female Swivel | H1000-40-60NH |
| 5" Storz to 4 1/2" NST Female Swivel | H1000-50-45NH |
| 5" Storz to 5" NST Female Swivel | H1000-50-50NH |
| 5" Storz to 6" NST Female Swivel | H1000-50-60NH |

Please call for special thread pricing



*Due to the volatility in the market, our pricing is, unfortunately, subject to change without notice. Please check our website or call us for the most up to date pricing.

Harrington H810 Gate Valve w/ 25° Elbow



This LDH hydrant gate valve has the following features: slow open/close, a 25-degree elbow, and low friction loss due to a high flow waterway design. The lightweight gate valve has a non-rising stem, an air bleeder valve, a field adjustable pressure relief valve, an anodized gate, and a stainless steel spindle. Dimensions: Extension: 12.5" Width: 7" Height: 15" Weight: 24 lbs

Description

4" Storz to 4" NST Female Swivel Rocker Lug
 4" Storz to 4 1/2" NST Female Swivel Rocker Lug
 4" Storz to 5" NST Female Swivel Rocker Lug
 4" Storz to 6" NST Female Swivel Rocker Lug
 4" Storz to 4" Storz
 5" Storz to 4" NST Female Swivel Rocker Lug
 5" Storz to 4 1/2" NST Female Swivel Rocker Lug
 5" Storz to 5" NST Female Swivel Rocker Lug
 5" Storz to 6" NST Female Swivel Rocker Lug
 5" Storz to 5" Storz

Part Number

H810-40-40NH
 H810-40-45NH
 H810-40-50NH
 H810-40-60NH
 H810-40-40ST
 H810-50-40NH
 H810-50-45NH
 H810-50-50NH
 H810-50-60NH
 H810-50-50ST

Harrington H800 4" Straight Gate Valve



This LDH hydrant gate valve provides low friction loss due to a high flow design. It is excellent for hydrant discharge control, due to providing a slow open/close mechanism. The lightweight gate valve has an air bleeder valve, a non-rising stem, an anodized gate, and a stainless steel spindle. Dimensions: H: 14" L: 10" W: 6" Weight: 21 lbs Friction loss: 1000 GPM: 0.8 PSI

Description

4" Storz to 4" NST Female Swivel
 4" Storz to 4 1/2" NST Female Swivel
 4" Storz to 5" NST Female Swivel
 4" Storz to 6" NST Female Swivel
 4" Storz to 4" Storz
 5" Storz to 4" NST Female Swivel
 5" Storz to 4 1/2" NST Female Swivel
 5" Storz to 5" NST Female Swivel
 5" Storz to 6" NST Female Swivel
 5" Storz to 5" Storz

Part Number

H800-40-40NH
 H800-40-45NH
 H800-40-50NH
 H800-40-60NH
 H800-40-40ST
 H800-50-40NH
 H800-50-45NH
 H800-50-50NH
 H800-50-60NH
 H800-50-50ST

Harrington H600 Super Flow 2-Way Ball Valve



Large, light-weight 2-way LDH ball valve. Feed two LDH hoses from a single LDH line or one LDH hose from two LDH hoses. The Super Flow ball valve has low friction loss due to a high flow waterway design. Hard anodized balls with stainless steel tappets for corrosion resistance. This design permits feed from either direction. Includes an adjustable pressure relief valve for added safety. Dimensions: Length: 18" Width: 16" Height: 12" Weight: 47 lbs

Description

4" Storz by (2) 4" Storz
 5" Storz by (2) 5" Storz

Part Number

H600-40-40ST
 H600-50-50ST

*Due to the volatility in the market, our pricing is, unfortunately, subject to change without notice. Please check our website or call us for the most up to date pricing.

Harrington H200 2-Way Ball Valve



Mid-Size 2-way LDH ball valve for feeding two lines with one large line. A lightweight valve with powder coating for a lasting finish. Hard anodized balls with stainless steel tappets for corrosion resistance. The design permits feed on either direction. Dimensions: L: 10.5" W: 9" H: 10" Weight: 14 lbs

Description

4" Storz to (2) 2 1/2" NST Male Rigid
5" Storz to (2) 2 1/2" NST Male Rigid

Part Number

H200-40-25NH
H200-50-25NH

Harrington H400 5-Way Manifold



Lightweight, 5-way LDH manifold, feeds four smaller lines from one LDH line and also has one straight through LDH outlet. The balls are hard anodized with stainless steel tappets for corrosion resistance. The manifold has an adjustable pressure relief valve and a liquid-filled pressure gauge. Dimensions: L: 17" W: 24" H: 13" Weight: 51 lbs

Description

4" Storz Intake to (4) 2 1/2" NST Male Rigid outlets and (1) 4" Storz Gated Outlet.

Part Number

H400-40-40-25NH

5" Storz Intake to (4) 2 1/2" NST All Male Rigid outlets and (1) 5" Storz Gated Outlet.

H400-50-50-25NH

Harrington H700 LDH Hydrant Valve



Excellent for boosting pressure on long hose lays or for boosting low hydrant pressures. The light-weight hydrant valve enables the first-in pumper to lay LDH directly from the hydrant to the fire and when hose lay is completed, start flowing water from the hydrant. If additional pressure is required, another pumper can connect to the Hydrassist valve and start pumping to raise pressure and flow without interrupting the established water supply. The valve provides an emergency shut-down capability. Choose from a variety of sizes of Storz or NST connections. Dimensions: H: 13" L: 12.75" W: 17" Weight: 35 lbs

Description

(3) 4" Storz to 4 1/2" NST Female Swivel

Part Number

H700-40-45NH

(3) 5" Storz to 4 1/2" NST Female Swivel

H700-50-45NH

Harrington HJ20 Jumbo Siamese Double Clappered



Large two-way Clappered Siamese, excellent design for supplying one "LDH" line from two "LDH" lines. Siamese features rubber covered convenient carrying handle. Inlets are individually Clappered. Specify the size of Storz or NST connections. Dimensions: L: 18" W: 14" H: 9" Weight: 26 lbs

Description

4" Storz by (2) 4" Storz
5" Storz by (2) 4" Storz
5" Storz by (2) 5" Storz

Part Number

HJ20-40-40ST
HJ20-50-40ST
HJ20-50-50ST

*Due to the volatility in the market, our pricing is, unfortunately, subject to change without notice. Please check our website or call us for the most up to date pricing.

Harrington H220 2-Way Clappered Siamese



Lightweight, single clappered Siamese for supplying one LDH line from two smaller lines. The aluminum alloy is powder-coated for a long-lasting finish and corrosion resistance. The one clapper design will close off the nonpressurized inlet while permitting flow from the pressurized inlet. Choose from a variety of sizes of Storz or NST adapters.

Dimensions: Length: 10.5" Width: 9.5" Height: 8" Weight: 11 lbs

Description	Part Number
4" Storz to (2) 2 1/2" NST Female Rocker Lug	H220-40-25NH
5" Storz to (2) 2 1/2" NST Female Rocker Lug	H220-50-25NH

Harrington H330 3-Way Clappered Siamese



Lightweight, 3 way clappered Siamese for supplying one LDH line from up to three smaller lines, each clappered individually. Specify the size of Storz or NST connections.

Dimensions: L:15.5" W: 14" H: 9" Weight: 9 lbs

Description	Part Number
4" Storz to (3) 2 1/2" NST Female Swivel	H330-40-25NH
5" Storz to (3) 2 1/2" NST Female Swivel	H330-50-25NH

Harrington HHBV Hydrant Ball Valve



Quarter turn, 2.5" ball valve for double dressing hydrants, tanker fill site, inline water flow control, or other portable uses. Lightweight durable ball valve, 2.5" NH FM swivel X 2.5" NH M, quarter turn, hard coated ball, flow at 60 PSI is over 900 GPM, multiple portable uses for control of water flow.

Description	Part Number
2 1/2" Male Outlet x 2 1/2" Threaded Inlet	HHBV-25NHM-25NH

Butterfly Valve w/ Bleeder - BFV



Description	Part Number
Butterfly Valve w/ Lever Handle, 6" NST Female Swivel x 6" NST Male	BFVL60160M

*Other sizes available, please call for pricing

Please call for special thread pricing

*Due to the volatility in the market, our pricing is, unfortunately, subject to change without notice. Please check our website or call us for the most up to date pricing.

1581 Leader Line Wye - Pyrolite®

2 1/2" Female inlet x (2) 1 1/2" male outlets
Self-Locking Tork-Lok® handles



1581

1573 Water Thief - Pyrolite®

1 - 2 1/2" Female inlet x (1) 2 1/2" and (2) 1 1/2" male outlets
Self-Locking Tork-Lok® handles



1573

2581 Leader Line Wye - Pyrolite®

2 1/2" Female inlet x (2) 1 1/2" male outlets
Rugged die cast handles



2581

1828 2 1/2" Hydrant Valve - Pyrolite®

2 1/2" Female inlet x 2 1/2" male outlet
Self-Locking Tork-Lok® handles



1828

1582 Hydrant Wye - Pyrolite®

2 1/2" to 6" Female or 4" or 5" Storz Inlet x (2) 2 1/2" male outlets
Self-Locking Tork-Lok® handles



1582

2285 2 1/2" Gate Valve - Pyrolite®

2 1/2" Female inlet x 2 1/2" male outlet



2285

2 1/2"F
3"F
3 1/2"F

4" F or 4" Storz
4 1/2"F
5" F or 5" Storz
6"F



1583

1583 Suction Siamese - Pyrolite®

2 1/2" to 6" Female or 4" or 5" Storz Outlet x (2) 2 1/2" female inlets
Self-Locking Tork-Lok® handles

2 1/2"F
3"F
4"F

4 1/2"F
5"F
6"F

B-100A Elk-O-Lite® Ball Valved Wye

2 1/2" Female inlet x (2) 1 1/2" male outlets
Rugged, flexible molded urethane handles

B-100A



BG-104A Elk-O-Lite® Water Thief

2 1/2" Female inlet x (2) 1 1/2" male outlets & (1) 2 1/2" male outlet. Positive twist lock handles

BG-104A



B-97A Elk-O-Lite® Ball Valved Wye

2 1/2" to 6" Female Inlet x (2) 2 1/2" male outlets
Positive twist lock handles



B-97A

2 1/2"F
3F"
3 1/2F"

4"F
4 1/2"F
5"F
6"F

B-99A Elk-O-Lite® Ball Valved Siamese

(3) 2 1/2" Female inlets x 2 1/2" to 6" Female outlet
Positive twist lock handles

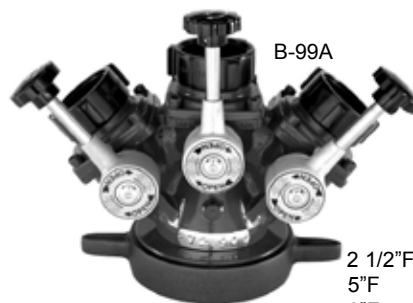

B-99A

2 1/2"F
5"F
6"F

B-96A Elk-O-Lite® Ball Type Hydrant Valve

2 1/2" Female inlet x 2 1/2" male locking Handle



B-96A

B-98A Elk-O-Lite® Ball Valved Siamese

2 1/2" to 6" Female Inlet x (2) 2 1/2" female outlets
Positive twist lock handles



B-98A

2 1/2"F
4"F
4 1/2"F
5"F
6"F

X-86A



X-86A Elk-O-Lite® Gate Type Hydrant Valve

2 1/2" Female inlet x 2 1/2" male

KEY HOSE ECO-10 - Attack and Supply Hose

A proprietary reverse twill weave construction reduces friction loss, while engineered yarn selections lighten the hose up to 25% compared to competitive offerings. Lightweight, double jacket construction, combining 100% premium ring spun staple and filament polyester fibers over a thin wall, high tensile, EPDM rubber liner. The outer jacket is mildew resistant and available with double-dip "Key-Lok" polyurethane-based polymer impregnation for abrasion and moisture resistance. This reliable, double jacket fire hose with Key-Lok treatment is tested to 600 and 800 psi, meets MIL-H-24606 latest edition for abrasion resistance, and is UL Listed*.

Features

- The rugged flexibility of filament polyester over a thin wall, high tensile EPDM rubber liner
- Extremely lightweight, easy to handle double jacket attack or supply line
- Combines minimum weight with maximum flexibility and abrasion resistance
- Mildew, chemical, and UV resistant
- *10-year manufacturer's warranty and guaranteed not to delaminate for the life of the hose



Specifications

Hose Size	Coupling Size	Part No.	Service Test	Proof Test	Burst Test	Bowl Size	Weight Uncoupled	Colored Key-Lok		White Untreated	
								50'	100'	50'	100'
**1½"	1½"	DP15-800-ECO	400 psi	800 psi	1200 psi	1-15/16"	0.23 lbs/ft	----	----	----	----
*1¾"	1¾"x1½"	DP17-800-ECO	400 psi	800 psi	1200 psi	2-1/16"	0.28 lbs/ft	----	----	----	----
*2"	2"x1½"	DP20-800	400 psi	800 psi	1200 psi	2-2/5"	0.31 lbs/ft	----	----	----	----
**2½"	2½"	DP25-800-ECO	400 psi	800 psi	1200 psi	3"	0.42 lbs/ft	----	----	----	----
*3"	3"x2½"	DP30-800-ECO	400 psi	800 psi	1200 psi	3-3/8"	0.56 lbs/ft	----	----	----	----

*UL Listed to 400 psi | **UL Listed to 400 psi and FM Approved

Key-Lok Colors Available

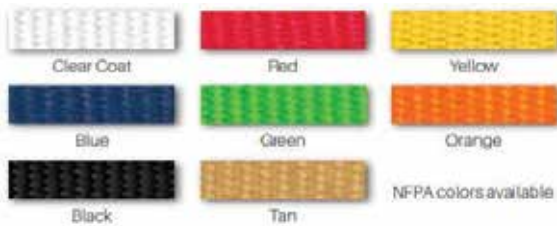

1½" thru 3" hose is supplied with NH (NST) aluminum couplings.

Custom lengths and special threads are available; please call us for pricing.

Freight Charges: Call for a freight quote.

FORESTRY FIRE HOSE

FORESTGUARD II®

Tough, all synthetic, ULC approved non-percolating forestry hose

APPLICATIONS

- Forestry lightweight, attack / supply hose
- Urban interface, grass fire kits, and mop up hose
- Wildland brush fire truck attack hose
- Cottage and forestry home values protection hose

FEATURES AND BENEFITS

- A tough versatile lightweight forestry fire hose
- Unique Mertex® lining
- Premium all synthetic single jacket
- Available with Permatek HP™ treatment against abrasion, moisture pick up and mildew
- Resistant to most chemicals, petrol products, ozone and U.V. exposure, hydrolysis, and rot and mildew
- Remains flexible to -65° F (-55° C)
- Meets or exceeds all performance requirements of NFPA 1961, Underwriters' Laboratories of Canada Spec
- S518.1, Factory Mutual and USDA Spec 5100-187 for 1" (25mm) and 1 1/2" (38mm)
- Meets ULC requirements and can be labeled upon request in the sizes* specified below



175100501T	1" x 50'
175101001T	1" x 100'
175150501T	1 1/2" x 50'
175151001T	1 1/2" x 100'

*All hose to be RED in color
*Price includes aluminum couplings
NH (NST) FOB factory.

KEY HOSE DURA-FLOW - Rubber Covered Attack Hose

The lightweight, small diameter, rubber covered attack hose that packs a big punch.

The heat and chemical resistant nitrile/PVC through-the-weave design provide peak performance and maximum flow. With a test pressure of 600 psi, Dura-Flow clearly outperforms conventional rubber covered attack lines. A rugged, thick-ribbed outer jacket construction makes the hose highly resistant to kink, impact, punctures, cuts, and abrasion. Ozone resistant, maintenance-free, and no drying required, make Dura-Flow a reliable weapon in a firefighter's arsenal. NFPA compliant and UL listed.

Features

- Lightweight, greater flexibility, and virtually kink-free
- Raised thick rib construction, resists cuts, punctures, impact, and abrasion
- Through-the-weave design for increased durability
- Heat, chemical, and ozone resistant
- Easy to clean, easy to pack
- *Dura-Flow hose shall carry a 10-year written warranty against defects in materials and workmanship.



Specifications

Hose Size	Coupling Size	Part No.	Service Test	Proof Test	Burst Test	Bowl Size	Weight Uncoupled	50'	100'
1½"	1½"	RC15-600	300 psi	600 psi	900 psi	1-13/16"	0.24 lbs/ft	----	----
*1¾"	1¾"x1½"	RC17-600	300 psi	600 psi	900 psi	1-15/16"	0.28 lbs/ft	----	----
2"	2"x1½"	RC20-600	300 psi	600 psi	900 psi	2¼"	0.32 lbs/ft	----	----
*2½"	2½"	RC25-600	300 psi	600 psi	900 psi	2-13/16"	0.48 lbs/ft	----	----
3"	3"x2½"	RC30-600	300 psi	600 psi	900 psi	3-3/8"	0.56 lbs/ft	----	----

*UL Listed to 250 psi



1½" thru 3" hose is supplied with NH (NST) aluminum couplings.

Custom lengths and special threads are available; please call us for pricing.

Freight Charges: Call for a freight quote.

LARGE DIAMETER HOSE

KEY HOSE PRO-FLOW - Heavy Duty Lightweight Large Diameter Hose

A lightweight, heat-resistant, large diameter supply hose that delivers superior flow during fireground operations.

Ozone and chemical resistant, the nitrile/PVC through-the-weave design allows the hose to expand under pressure — decreasing friction loss and increasing water flow. The thin rib rubber outer cover offers increased resistance to impact, punctures, and abrasion. Reliable, maintenance-free, and no drying required, make this the ideal supply hose for municipal and industrial fire departments. NFPA compliant and UL Listed*.

Features

- Lightweight, large diameter with superior flow capability
- Raised thin rib construction resists cuts, punctures, impact, and abrasion
- Through-the-weave design for increased durability
- Heat, chemical, and ozone resistant
- *Pro-Flow hose shall carry a 10-year written warranty against defects in materials and workmanship.



Specifications

Hose Size	Part No.	Service Test	Proof Test	Burst Test	Bowl Size	Weight Uncoupled	25'	50'	100'
**4"	RC40-500	250 psi	500 psi	750 psi	4¼"	0.74 lbs/ft	----	----	----
**5"	RC50-450	225 psi	450 psi	675 psi	5¼"	0.93 lbs/ft	----	----	----
6"	RC60-450	225 psi	450 psi	675 psi	6¼"	1.35 lbs/ft	----	----	----

*UL Listed to 300 psi | **UL Listed to 200 psi



4" thru 6" hose is supplied with Storz aluminum couplings.

Custom lengths and special threads are available; please call us for pricing.

Freight Charges: Call for a freight quote.



- Low temperature PVC construction
- Clear web for visual monitoring
- Black ridged helix
- High flexibility -40° to +150° F
- Smooth bore for unrestricted flow
- Special lengths available



Storz -7



Storz w/
Handles
-71



Long Handle
-51



Rocker Lug
-52



Camlock -4

Note: All PVC Suction Hoses are strictly drafting hoses and must not be used on Hydrants or in Pressure Applications.

Part#	Size	Length	NST THREAD		STORZ		CAMLOCK
			_51	_52	_7	_71	_4
Part#	Size	Length	Long Handle	Rocker Lug	No Handle	Long Handle	Camlock
2P60__	6.0"	10'					
2P50__	5.0"	10'					
2P45__	*4.5"	10'					
2P40__	4.0"	10'					
P30__	3.0"	10'					
P25__	**2.5"	10'					
P15__	1.5"	10'					

Ordering Example: 2P6051 = 6" x 10' NST Long Handle Female to NST Rocker Lug Male
 2P6052 = 6" x 10' NST Rocker Lug Female to NST Rocker Lug Male
 *5.0" hose with 4.5" threaded coupling **3.0" hose with 2.5" threaded coupling

Other Lengths available upon request, please call for pricing.

*Due to the volatility in the market, our pricing is, unfortunately, subject to change without notice. Please check our website or call us for the most up to date pricing.

HS-150 The 150 Foot Hose Strap

This strap securely holds 50', 100', or 150' of 1 3/4" double jacketed fire hose... the most commonly used attack hose in the fire service. Ideal for cross lays, quick attack lines or standpipe operations. Strap consists of two quick release Velcro closures, interconnected by a stiff nylon spine, Hose remains organized and ready for rapid and easy deployment. The Hose Strap enables a firefighter to grab a fold of hose, shoulder it, and lay it out. Once at your point of attack, straps can be opened and hose advanced. Designed for fire departments that want to deploy an exact amount of 1 3/4" hose to the firescene or to the standpipe station.

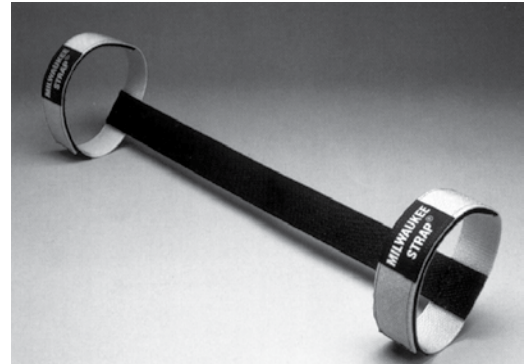

GRP-57 Gripper Hose System

Consists of three heavy duty nylon straps, with a padded shoulder sling, all sewn together to create a hose harness. The shoulder sling has Scotchlite bound edges. Comes complete with fiberglass reinforced cam buckles and torque rings that cinch up the bundle during transport. Ideal for transporting hose assemblies to the fire ground or up the stairs to a standpipe location.



Hose Rollers

For easy removal of air and water from hose. Simply walk the hose. For use up to 5" LDH

- HHR-2 Two Man Hose Roller
- HHR-1 One Man Style Hose Roller



HHW-300 Harrington Hose Washer

Harrington hose washers, easy and efficient method to wash and clean your hoses.

For hoses up to 3". Just connect a supply line with up to 60 PSI pressure and feed your dirty hose into the washer and out comes a much cleaner hose.

Includes a carrying handle and supporting feet.
Constructed of durable lightweight aluminum.
Available in 1.5" or 2.5" NH-female inlet swivel connection.



- HHW-300-15NH 1.5"
- HHW-300-25NH 2.5"

*Due to the volatility in the market, our pricing is, unfortunately, subject to change without notice. Please check our website or call us for the most up to date pricing.



Akron UltraJet Nozzle

Now you can have the best of both worlds in a handline nozzle. The UltraJet nozzle is all-in-one, combining both smooth bore and fog patterns. This nozzle has simple operations with no additional training required. Available with 1" (25 mm), 15/16" (24 mm), 7/8" (22 mm) or 3/4" (19 mm) tips. Low Pressure operation at 50 psi/3.5 Bar.



1820 UltraJet Nozzle - 1.5" or 2.5" Inlet

Style	Description	Swivel Inlet	Length	Weight lbs. (kg)	GPM	LPM
1820	UltraJet Nozzle w/ pistol grip & spinning teeth	1 1/2" or 2 1/2" (38 or 65 mm)	12"	6.2 lbs (2.8 kg)	118 to 297 GPM	447 to 1124 LPM

Akron ProVenger™ Nozzle

The patent pending ProVenger series of handline nozzles combine years of designing and manufacturing experience with superior performance and dependability; all at an unbeatable value. Available in selectable and fixed gallonage, the Avenger global platform offers great stream quality and a simple design. Durable, reliable and affordable, the Avenger.



- Lightweight fog and straight stream nozzle with multiple fixed or constant gallonage settings
- Great stream performance
- Multiple pattern detents
- Integrated control ring does not require you to flush the nozzle without shutting down
- Quick change pattern adjustment (90 degrees of rotation from Straight Stream to Full Fog)
- NFPA Compliant
- 5 Year Warranty
- Raised lug on the bumper for easier pattern identification
- Easy to operate with simplified nozzle training
- Meets European CE Standard (Must Specify)

1616 1 1/2" ProVenger™ Selectable Gallonage nozzle w/ pistol grip & spinning teeth

4116 1 1/2" ProVenger™ Fixed Gallonage nozzle w/ pistol grip & spinning teeth

1602 1" ProVenger™ Selectable Gallonage nozzle w/ pistol grip & spinning teeth

Style	Description	Swivel Inlet	Length	Weight lbs. (kg)	GPM	LPM
1616	1 1/2" ProVenger SG nozzle w/pistol grip & spinning teeth	1 1/2" or 2 1/2" (38 or 65 mm)	10 1/2"	4.3 (2 kg)	30-60-95-125-150	115-230-360-475-550
4116	1 1/2" ProVenger FG nozzle w/pistol grip & spinning teeth	1 1/2" or 2 1/2" (38 or 65 mm)	10 1/2"	4 (1.8 kg)	See Avenger FG	
1602	1" ProVenger SG nozzle w/pistol grip & spinning teeth	1" (25.4 mm)	9 1/4"	3 (1.4 kg)	Pressure and Flow charts	

Akron Zero Torque™ Nozzles

The Zero Torque (ZT) nozzle is the first nozzle specifically designed with ergonomics, handling, control and reduced firefighter fatigue in mind. The ZT naturally keeps the nozzle out in front of the firefighter to allow for easier operation and provide better control. In addition the pistol grip and inlet swivel are positioned to eliminate the reaction force torque found in all conventional pistol grip designs. Conventional pistol grip nozzles are held at a position 3 1/2" to 4" below the center line of discharge, creating a natural torque which must be resisted by the firefighter. The ZT is positioned to eliminate the torque, leaving only the straight reaction force for the firefighter to resist. The ZT is available on any 1 1/2", Mid-Range, Wide-Range, and 2 1/2" Turbojet or Assault nozzle.

Superior Handling: The ZT pistol grip and inlet swivel are positioned to eliminate the reaction torque found in conventional designs providing reduced short-term fatigue and better overall handling.



Akron Forestry Nozzle

Small lightweight nozzles designed for the rugged simplicity needed for forestry/wildland applications. A dual flow adjustable pattern nozzle with a simple twist operation allows you to switch to the following settings: Off, Low flow straight stream, Low flow narrow fog, High flow straight stream, High flow fog

1030 1" Forestry Nozzle

Style	Inlet	Length	Weight lbs. (kg)	Flow at 100 PSI	
				GPM	LPM
1030	1" (25mm)	4"(102mm)	1/2 (.2kg)	10-30	38-115

1030



Assault Nozzles combine quality stream performance at a variety of pressures with the simplicity of a fixed orifice. Quality stream performance at a variety of pressures, combined with a durable and simple design makes it an unbeatable value. This product has a variety of applications. For use as deicing nozzles or in firefighting, mining or specialty vehicle applications, the Assault Nozzle is versatile and durable.

Features:

- Better stream performance at pressures as low as 50 PSI
- No recalibration required
- Pattern Identification
- Raised lug marks straight stream for limited visibility operations
- Affordably priced
- Low maintenance due to simple, durable design
- Larger easy to read labels
- Easy to operate (1/4 turn from straight stream to fog)
- Simplified nozzle training
- Quick change pattern adjustment

4802 Akron 1" Low-Range Assault Nozzle

With Pistol Grip

- 100 psi. Maximum hydrostatic pressure 580 psi.
- Compatible with Quick-Attack Foam Tube Style 790
- Nozzle is standard with Pistol Grip and Spinning Teet
- FM Approved
- 13, 25, or 40 GPM (must specify)
- Swivel 1" Inlet
- Length 8 15/16"
- Weight 3 1/4 lbs



4802



4824 Akron 1 1/2" High-Range Assault Tip

- Specify Pressure and Flow
- Nozzle is standard with Spinning Teeth
- Swivel 1 1/2" Inlet
- Length 8 1/4"
- Weight 5 1/4 lbs



4824

4863 Akron 1 1/2" Mid-Range Assault Nozzle

With Pistol Grip

- Improved handle with extra room for 1-3/4" hose
- Tough, black nozzle body hard coat
- Enhanced flow characteristics (deeper throat design)
- Meets European Standard
- Specify Pressure and Flow
- Compatible with Quick-Attack Foam Tube Style 796
- Removable Pistol Grip
- 1 1/2" Full-time Swivel Inlet
- Length 9"
- Weight 4 1/4 lbs



4863

4866 Akron 1 1/2" Mid-Range Assault Tip

- Specify Pressure and Flow
- Compatible with Quick-Attack Foam Tube Style 796
- 1 1/2" Swivel Inlet
- Length 6 1/2"
- Weight 2 3/4 lbs



4866

4826 Akron 1 1/2" or 2 1/2" High Range Assault Nozzle

With Pistol Grip

- Enhanced flow characteristics with a deeper throat design
- Specify Pressure and Flow
- Nozzle is standard with Pistol Grip and Spinning Teeth
- FM Approved (specific models)
- Swivel 1-1/2" or 2-1/2" Inlet
- Length 12-1/8"
- Weight 7 5/8 lbs



4826

Nozzle Color Clip Kit

Your Assault nozzle will include a free nozzle color code kit, if requested. No mechanical fasteners, simple to switch, just snap-on. Includes (6) bail handle clips and (6) pistol grip clips in the following colors: Black, Blue, Green, Orange, Yellow, White



Pressure & Flow For Mid-Range Assault Nozzles

NOZZLE PSI	150 @ 50	150 @ 75	150 @ 100	161 @ 50	175 @ 50	175 @ 75	175 @ 100	185 @ 50	200 @ 50	200 @ 75	200 @ 100	210 @ 50	225 @ 100
	Actual GPM												
50	150	122	106	161	175	143	124	185	200	163	141	210	159
75	184	150	130	197	214	175	152	227	245	200	173	257	195
100	212	173	150	228	247	202	175	262	283	231	200	297	225

Pressure & Flow Options for High-Range Assault Nozzles

NOZZLE PSI	200 @ 75	200 @ 100	250 @ 50	250 @ 75	250 @ 100	300 @ 75	300 @ 100	350 @ 100
	Actual GPM							
50	163	141	250	204	177	245	212	247
75	200	173	306	250	217	300	260	303
100	231	200	354	289	250	346	300	350

The Akron® Turbojet Nozzle is unmatched in today's fire service for its flexibility and flow control. The Turbojet is a constant gallonage nozzle (flow remains the same in all patterns) with multiple flow settings for operator flow control. Use the Turbojet one time and it is easy to see why it's the nozzle of choice by firefighters worldwide.

Features:

- Pattern Identification
- Larger more legible labels
- Simple to operate (1/4 turn from straight stream to fog)
- Raised lug marks straight stream for limited visibility operations
- Easy to service & repair

1702 Akron 1" Turbojet Nozzle

With Pistol Grip

- Flow setting at 100 psi (7 bar) operating pressure (230 psi/16 bar maximum operating pressure), maximum hydrostatic pressure 40 bar
- Compatible with Quick-Attack Foam Tube Style 790
- Removable pistol grip
- Type Selectable Gallonage
- GPM 13-25-40-60*
- Swivel 1" Inlet
- Length 9 1/4"
- Weight 3 lbs



1702

1703 Akron 1 1/2" Turbojet Tip

- Flow setting at 100 psi (7 bar) operating pressure (230 psi/16 bar maximum operating pressure), maximum hydrostatic pressure 40 bar
- Compatible with Quick-Attack Foam Tube Style 790
- For use on Style 753 shutoff
- Type Selectable Gallonage
- GPM 13-25-40-60*
- Swivel 1 1/2" Inlet
- Length 6 5/8"
- Weight 1 3/4 lbs

1703



1714 Akron 1 1/2" Turbojet Tip

- Flow settings at 100 psi (7 bar) standard, 75 psi (5 bar) optional
- Compatible with Quick-Attack Foam Tube Style 792
- Type Selectable Gallonage
- GPM 30-60-95-125
- Swivel 1 1/2" Inlet
- Length 6 7/8"
- Weight 2 1/4 lbs

1714



1704 Akron 1" Turbojet Nozzle

With Pistol Grip

- Flow setting at 100 psi (7 bar) operating pressure (230 psi/16 bar maximum operating pressure), maximum hydrostatic pressure 40 bar
- Compatible with Quick-Attack Foam Tube Style 790
- Removable pistol grip
- For use on Style 753 shutoff
- Type Selectable Gallonage
- GPM 18-30 or 13-23-30*
- Swivel 1" Inlet
- Length 9 1/4"
- Weight 3 lbs

1704



1720 Akron 1 1/2" Turbojet Nozzle

With Pistol Grip

- Flow settings at 100 psi (7 bar) standard, 75 psi (5 bar) optional
- Compatible with Quick-Attack Foam Tube Style 792
- Removable pistol grip
- Type Selectable Gallonage
- GPM 30-60-95-125
- Swivel 1 1/2" Inlet
- Length 10 3/4"
- Weight 4 lbs

1720



1711 Akron 1 1/2" Turbojet Nozzle

- Flow setting at 100 psi (7 bar) operating pressure (230 psi/16 bar maximum operating pressure), maximum hydrostatic pressure 40 bar
- Compatible with Quick-Attack Foam Tube Style 790
- For use on Style 753 shutoff
- Type Selectable Gallonage
- GPM 18-30 or 13-23-30*
- Swivel 1 1/2" Inlet
- Length 6 5/8"
- Weight 3 3/4 lbs

1711



1763 Akron 1½" or 2½" Wide-Range Turbojet Nozzle

With Pistol Grip

- Flow setting up to 100 psi (7 bar) standard, 75 psi (5 bar) optional
- Compatible with Quick-Attack Foam Tube Style 796
- Removable pistol grip
- Type Selectable Gallonage
- GPM 30-95-125-150-200 or 115-360-475-550-750
- Swivel 1 1/2" Inlet Standard or Optional 2 1/2" Inlet
- Length 11"
- Weight 5 3/4 lbs



1763



1766 Akron 1½" Wide-Range Turbojet Tip

- Flow settings at 100 psi (7 bar) standard, 75 psi (5 bar) optional
- Compatible with Quick-Attack Foam Tube Style 796
- Type Selectable Gallonage
- GPM 30-95-125-150-200
- Swivel 1 1/2" Inlet
- Length 7 1/2"
- Weight 3 1/2 lbs



1766

1723 Akron 1½" Mid-Range Turbojet Nozzle

With Pistol Grip

- Flow setting up to 100 psi (7 bar) standard, 75 psi (5 bar) optional
- Compatible with Quick-Attack Foam Tube Style 793
- Removable pistol grip
- Type Selectable Gallonage
- GPM 95-125-150-200
- Swivel 1 1/2" Inlet
- Length 10 3/4"
- Weight 6 1/2 lbs



1723

1737 Akron 1½" Mid-Range Turbojet Tip

- Flow settings at 100 psi (7 bar) standard, 75 psi (5 bar) optional
- Compatible with Quick-Attack Foam Tube Style 793
- Type Selectable Gallonage
- GPM 95-125-150-200
- Swivel 1 1/2" Inlet
- Length 6 5/8"
- Weight 4 1/2 lbs



1737

1733 Akron 2½" High-Range Turbojet Nozzle

With Pistol Grip

- Flow setting up to 250 GPM (950 LPM) at 100 psi (& bar) standard, 75 psi (5 bar) optional
- Compatible with Quick-Attack Foam Tube Style 770
- Removable pistol grip
- Type Selectable Gallonage
- GPM 125-150-200-250
- Swivel 2 1/2" Inlet
- Length 11 1/2"
- Weight 6 3/4 lbs



1733

1744 Akron 1½" High-Range Turbojet Tip

- Flow setting up to 100 psi (& bar) standard, 75 psi (5 bar) optional
- Compatible with Quick-Attack Foam Tube Style 770
- Type Selectable Gallonage
- GPM 125-150-200-250
- Swivel 1 1/2" Inlet
- Length 6"
- Weight 4 1/2 lbs



1744

Nozzle Color Clip Kit

Your Turbojet nozzle will include a free nozzle color code kit, if requested. No mechanical fasteners, simple to switch, just snap-on. Includes (6) bail handle clips and (6) pistol grip clips in the following colors: Black, Blue, Green, Orange, Yellow, White



Pyrolite shutoff with pistol grip and straight tip for high volume low pressure application. The Blitz Tips deliver nearly 400 GPM at 50 psi pitot pressure.



STYLE 1446

1445 Shutoff with Pistol Grip and Straight Tip
 1 1/2" swivel inlet x 1 1/2" male
 1 1/2" waterway with 1 3/8" orifice
 Length: 10", weight: 3 3/8 lbs.

1446 Shutoff with Pistol Grip and Straight Tip
 2 1/2" swivel inlet x 1 1/2" male
 1 3/8" waterway with 1 3/8" orifice
 Length: 10 5/8", weight: 4 1/8 lbs.

Saber™ Shutoffs with Integral Tip

Lightweight ball shutoff with an integral straight bore tip. Full 1-3/8" waterway. Pyrolite finish. Orifice options: 3/4", 7/8", 15/16", 1" and 1 1/8"

1 1/2" Length: 5 7/8"
 2 1/2" Length: 7 3/8"



STYLE 2431

2431 Saber Shutoff with Pistol Grip
 1 1/2" swivel inlet x 1 1/2" male
 3 lbs.

2433 Saber Shutoff with Pistol Grip
 2 1/2" swivel inlet x 1 1/2" male
 3 1/2 lbs.

Shutoff with Dual Stacked Tips - Pyrolite

A lightweight ball shutoff with two tips for use where a fog nozzle is not required. Minimum maintenance for longer and more trouble-free operation. Base tip has a female thread on the outlet for added protection and durability. Full 1-3/8" waterway.



1441 Shutoff with Pistol Grip and Dual Stacked Tips
 15/16" and 1/2" Tips
 1 1/2" swivel inlet
 Length 3/8", weight: 2 7/8 lbs.

1443 Shutoff with Pistol Grip and Dual Stacked Tips
 1 1/8" and 1/2" Tips
 2 1/2" swivel inlet
 Length: 11 1/2", weight: 3 1/2 lbs.

The **Chief XD** takes the industry standard for handline nozzles to a whole new level. It offers accurate high volume flows at low tip pressures and is built tough like no other nozzle for Xtreme Duty, or XD. The Chief XD is the only handline nozzle that offers a forged shutoff body and forged metal bale handle for maximum strength. It also includes as standard a full round metal ball for the best stream performance, as well as fixed molded urethane or spinning stainless steel metal teeth that don't break. All indicators and markings are laser etched, with no labels to peel off or scratch. Ergonomic grip inserts help with handling and can also be color coded. It's durability and efficiency ensures an embedded level of safety for you and your crew, fire after fire.

- Accurate & wide range of flows
- Available with 50, 75, or 100 psi operating pressure
- Fixed gallonage from straight stream to full fog
- Forged aluminum shutoff body and bale handle
- Laser etched markings
- Dual drive shutoff with full round metal ball
- Spinning stainless steel or fixed molded urethane teeth
- Color coded bumper along with bale handle & pistol grip inserts

Chief XD Tips

- Mid-Range 1.5" Tip
- High-Range 1.5" Tip

Chief XD Nozzles

- Mid-Range 1.5"
- Mid-Range 1.5" w/ Pistol Grip
- High-Range 1.5"
- High-Range 2.5"
- High-Range 1.5" w/ Pistol Grip
- High-Range 2.5" w/ Pistol Grip

*Specify when ordering:

- Flow rate & pressure
- Bumper, bale handle, and pistol grip insert color (orange standard on XD)
Color Options: Red, Yellow, Green, Blue, Black, Glow
- Spinning stainless steel metal teeth (standard) or fixed molded urethane teeth
- Inlet threads

CHIEF XD™



Mid-Range Nozzle w/PG



Mid-Range Tip



Mid-Range Nozzle

Mid-Range Flow Options:			
150 @ 50	125 @ 75	95 @ 100	
160 @ 50	150 @ 75	125 @ 100	
175 @ 50	175 @ 75	150 @ 100	
	185 @ 75	175 @ 100	
	200 @ 75		

High-Range Flow Options:			
185 @ 50	250 @ 75	250 @ 100	
210 @ 50	300 @ 75		
250 @ 50			
265 @ 50			



Spinning Teeth Optional Molded Teeth

Elkhart Brass XD Shutoffs

Designed and constructed for rugged use and reliable performance. They are built strong with forged shutoff bodies and forged metal bale handles earning the title Xtreme Duty, or XD. They provide an excellent foundation for break-apart applications using smooth bore or fog nozzle tips. Elkhart Brass XD Shutoffs are available with a variety of options, including built-in smooth bore discharges that can be used with fog nozzle tips for maximum versatility.

- Dual drive shutoff with full round metal ball
- Forged aluminum shutoff body
- Forged metal bale handle
- Laser etched markings
- Color coded pistol grip and bale handle inserts
- Attention to detail in waterway alignment and smoothness of operation throughout

XD Shutoffs

- 1.5" Shutoff
- 1.5" Shutoff w/ Pistol Grip
(1.5" Inlet & 1.5" Outlet)

Smooth Bore Single Tip

- 187-XD 1.5" Inlet / 4.5" Length
- Available Discharges: 7/8", 15/16", 1", 1-1/16", 1-1/8", 1-3/16", 1-1/4"

XD Shutoffs w/ Integral Smooth Bore

- 1.5" Shutoff
- 1.5" Shutoff w/ Pistol Grip
(1.5" Inlet & 1.5" Outlet)
- 2.5" Inlet x 1.5" Outlet Shutoff
- 2.5" Shutoff w/ Pistol Grip
(2.5" Inlet & 1.5" Outlet)



187-XD



1.5 Shutoff



1.5 Shutoff w/PG



1.5 Shutoff w/ Integral Smooth Bore



2.5 Shutoff w/ Integral Smooth Bore & PG

*Specify when ordering:

- Bale and Pistol Grip insert colors (black standard)
Color Options: Red, Yellow, Green, Blue, Black, Glow
- Inlet/Outlet threads
- Integral Smooth Bore discharge size (if applicable)

The Apollo™ family of portable monitors can get the job done when seconds count. Choose either a Dual or Single Inlet Portable Monitor with an optional Direct Mount flange. All are available in either the standard version or new Hi-Riser™.

The entire Apollo monitor family incorporates proven performance, more durability and better stability to generate powerful streams and higher flows. These features and more make the Apollo the monitor of choice by users who need more reliable performance.

- Full 360° rotation in Deck mode - 180° rotation with built-in safety stops in Portable mode
- Vertical travel approaching 90° above to 15° below horizontal with a built-in 35° safety stop
- Full 3" waterway with built-in turning vanes in each elbow for maximum efficiency and lower friction loss - No more than 10 psi at 800 gpm (.7 bar at 3030 lpm)
- Multiple applications - Use as a Portable Monitor or add the Direct Mount flange for Deck Operation
- Quality Locking System - Simple, heavy-duty dual lock pins for quicker and easier assembly and more positive locking
- Direct Mount - A combination 3" NPT Female and 3" Flange allows for easy setup for Deck Operation
- More water on the fire with a harder-hitting, low fallout straight stream
- Sturdy ground base helps maintain stability
- Ground Base folds for easy storage in a standard compartment

APOLLO SINGLE INLET MONITORS

Flows up to 1250 gpm (4800 lpm) in the deck mode and 1000 gpm (3800 lpm) in the portable mode. Choice of ground bases: 4", 4 1/2", 5" female swivel, 4" or 5" storz inlet (must specify) x 2 1/2" threaded male outlet

3416 Apollo Single Inlet Portable and Deck Monitor
Includes a ground base, liftoff, and direct mount

3416
Shown with Style 5160 Akromatic® Nozzle



Nozzle and Tip Options for the Apollo Monitors



Style	Inlet	Outlet Male	GPM	Deck Flow GPM	Weight lbs Liftoff	Weight lbs Ground Base	Deck Height	COMPLETE	Less Pipe & Tips
3416	4", 4 1/2", 5" F, 4" or 5" Storz	2 1/2"	1000	1250	23	38 1/2	15"²		

Nozzle	Swivel Inlet	Length	Flow Range	Weight lbs	Type of Nozzle
5160	2 1/2" Female	9 1/2"	250-1250	11 1/4	Automatic
1755	2 1/2" Female	10"	500-750-1000-1250	13	Constant Flow

Tips	Base Thread	Middle Thrd	Top Thrd	Orifices	Length	Weight lbs
2499	2 1/2" Female	2" NH	1 1/2" NH	1 3/8", 1 1/2", 1 3/4", 2"	16 7/8"	2 7/8

Pipe	Size	Length	Wt. Lbs	Construction	Brass	Pyrolite	Chrome
3488	2 1/2" x 2 1/2"	10 1/2"	2 1/2'	Pyrolite Alum.Chrome, CB			

Akron® Apollos meet Insurance Services Office (ISO) requirements (Deck Operation only).

MERCURY QUICK ATTACK LE PORTABLE MONITOR

Hit Low, Hit Hard and Hit Far with the NEW Mercury™ Quick Attack LE Portable Monitor.

The Mercury Quick Attack LE sets a new standard in the market and is the only portable monitor that meets NFPA 1964 and EN-15767-1. It is compact and lightweight at 15 pounds and flows 500 GPM. Now even better, it can hit low at 10° and far up to 250 feet at 100 psi. Easy and quick to deploy, friction loss is minimal.

- Hits low at 10°
- Improved reach up to 250 feet at 100 psi when paired with the new Mercury nozzle (Style 4446)
- Compact size & weighing only 15 lbs for quick deployment
- Meets NFPA 1964 and EN-15767-1
- Easy open/close valve
- Strap attached with bag for easy stowing
- Knurled handle for improved grip
- Handle wiper to minimize debris collection
- Elevation range of +10° to +50°
- Rotation +/- 20°
- Rated flows up To 500 gpm (1900 lpm)
- Low 6 psi friction loss at 500 gpm
- Maximum operating pressure of 230 psi.
- Exceeds the standard of 200 psi



3444
Shown with Style 4446 Nozzle

3444 Mercury Quick Attack Monitor (monitor only)

Nozzle and Tip Options for the Mercury Monitors



Style	Weight	Height	Width	Length	Inlet	Outlet	Flow GPM
3444	14	9"	23 1/2" 7 1/4"	14 1/2" 2 1/2" or 3" Storz	2 1/2" F	2 1/2"	500

Nozzle	Swivel Inlet	Length	Flow	Weight lbs	Pattern Control
4446	2 1/2" Female	8.1"	250-375-500 GPM@100PSI	6	Manual
4445	2 1/2" Female	7"	500GPM@100PSI	5	Manual

Tips	Base Thread	Std Orifice	Optional Orifices	Length	Weight lbs
489	2 1/2" Female	1 1/2"	1 1/4", 1 3/8", 1 3/4", 2", 2 1/4"	9"	1
2420	2 1/2" Female	1"x1 1/8"x1 1/4"	1"x1 1/4"x1 1/2"	9 5/8"	1 1/2

Elkhart **Stinger® 2.0** Portable Monitor 8297

- Dual purpose break-apart monitor for use as a deck gun or portable monitor
- Numerous truck adapter and portable base options available to suit every need
- In portable mode, five forged aluminum legs with self-adjusting carbide-tipped ground spikes increase stability
- Rotation lock mechanism provides positive left-right lock with visual position indication
- By-passable safety stop at 35° above horizontal
- Safety strap for additional stability
- Lightweight for its class
- Most flow efficient in its class with a friction loss reducing 33/8" vaned waterway
- Patented monitor to base latching mechanism is user-friendly and provides visual indication of status
- Fully enclosed stainless steel worm gear
- Liquid filled pressure gauge
- Two carrying handles



8297 **Stinger® 2.0** Portable Monitor (8297-25 Shown)

Individual Price

Model SM-1250 X-Stream Nozzle®	Model 282-A Stream Shaper	Model ST-194 Quad Stacked Tips

8297 **Stinger® 2.0** Portable Monitor Choices*

- 8297-10 Upper Unit (without ground base)
- 8297-25 with (2) 2.5" F ground base
- 8297-35 with 3.5" F ground base
- 8297-40 with 4.0" F ground base
- 8297-45 with 4.5" F ground base
- 8297-51 with 5" Storz Ground Base

*All Prices include 282A Stream Shaper & ST-194 Stacked Tips

KEY CONFIGURATIONS (ACCESSORIES)

STORAGE BRACKET (3)	ANSI FLANGE TOP MOUNT (4)	LDH INLET BASE (6)	THE PIPE™ 2.0 (9)	DECK MOUNT ADAPTER (8)	PROTECTIVE COVER (10)	NPT TOP MOUNT (5)	SIAMESE INLET BASE (7)

Components & Options	Illustration	Model	
Truck Mount Adapters (8297-2.0)	1 x 3" NPT Female (without flange)	5	8298P 2.0
	1 x 3" - 150# ANSI	4	8298F 2.0
	2 x 2.5" Deck Mount	8	8299
Storage Bracket	Truck storage mounting bracket for portable base or complete monitor	3	8297-MB
The Pipe (8297-2.0)	Increases the height of a deck mounted Stinger 2.0 by 18 inches - constructed of Elk-O-Lite (approx 10lbs)	9	8298EX 2.0

*Please call for prices on any accessories or configurations not shown

Elkhart **RAPID ATTACK MONITOR** Portable Monitor 8296

- Easily deployed and operated by a single firefighter
- Patent pending hydraulic stability system harnesses reaction force to stabilize the monitor
- Four fold-out forged aluminum legs with carbide-tipped ground spikes extend to the largest footprint in its class for exceptional stability
- Rear ground spikes are angled to help carbide tips grip the surface
- Lock pin holds valve in a closed position to prevent accidental opening, allowing the R.A.M. to be carried attached to a charged line
- Patent pending design lowers friction loss and produces consistent stream quality in all ranges of motion
- Can be stored pre-connected
- Ergonomic U-shaped valve handle
- Attached safety strap includes storage pouch



(shown with nozzle sold separately)

8296 RAM XD Rapid Attack Monitor (monitor only)

Recommended Products

R.A.N.™	ST-197A STACKED TIP	181-A DELUGE TIP	282-A - MINI STREAM SHAPER	HF-500A HYDRO FOAM	Oscillating R.A.N.™	KEY CONFIGURATIONS (ACCESSORIES)
(3)	(4)	(5)	(6)	(7)	(8)	 TRUCK STORAGE MOUNT (2)

Components & Options			Illustration	Model	
R.A.N. Nozzle	Fixed	500 GPM (1893 LPM)	3	3896	
	Selectable	250-350/500 GPM (946/1325/1893 LPM)	3	3895	
	Oscillating	500 GPM (1893 LPM)	8	3890	
Self-Educting Nozzle	Fixed	500 GPM (1893 LPM) with configurable 1/2, 1, or 3% foam proportioning	7	HF-500A	
	Triple Stack Tip	Outlets: 1", 1-1/4", & 1-1/2"	4	ST-197-A	
	Triple Stack Tip	Outlets: 1-1/4", 1-1/8", & 1-1/2"	4	ST-197-A	
Accessories	Deluge Tip	Outlet: 1-1/8"	5	181-A	
	Mini Stream Shaper	For use with R.A.M. smooth bore nozzles	6	282-A Mini	
	Mounting Bracket	Truck storage mounting bracket for R.A.M.	2	8296-MB	

*Please call for prices on any accessories or configurations not shown

PORTABLE FOAM EDUCTORS

The first necessity of any handline foam system is a means of introducing foam concentrate into the water supply. The simplest, most efficient, and least expensive means of doing this is a portable foam eductor.

These "Venturi Type" eductors are constructed of rugged brass alloys. Their efficient and simple design assures the lowest possible friction loss. The metering devices on all these eductors are easily removed for cleaning or for training and are designed with a stainless steel ball check to prevent foam contamination when the line is shut down. They are also furnished with clear pvc pick-up hose and a removeable, easy to clean pick-up screen.

The metering device on the 60, 95, and 125 GPM eductors have 5 settings: ½%, 1%, 3%, 6%, and 0, (positive shutoff). The metering device on the 30 and 250 GPM eductor has infinite settings from 0 to 6%. Both devices are extremely suitable for todays fire-fighting foams: AFFF, Alcohol Type AFFF, Fluoroprotein, Class A foam, etc.

241 IN-LINE FOAM EDUCTOR

Available in 30, 60, 95, 125, and 250 GPM flows - Detachable metering device - Rugged brass construction - 60 and 95 GPM models are FM approved with SFL and 244 - Choice of free-swivel inlets (see chart below) - Finish red acrylicurethane enamel with Satin Brass or Chrome plated trim.

240 BY-PASS FOAM EDUCTOR

By-pass valve allows for water only operations at lower inlet pressures - Available in 60, 95, and 125 GPM flows - Detachable metering device Rugged brass construction - 60 and 95 GPM models are FM approved with SFL and 244 - Choice of free swivel inlets (see chart below) - Finish red acrylicurethane enamel with chrome plated trim.

241-N NAVY IN-LINE FOAM EDUCTOR

90 GPM flow - Detachable metering device is not adjustable (either 3 or 6%) - Rugged brass construction - Reinforced clear pvc pick-up hose - 1½" swivel inlet - Finish cast brass.

FOAM AERATION TUBES

The combination fog nozzle is ideal for the application of AFFF for these reasons: It has far greater reach than an air asperating nozzle so initial attack can be made from a greater distance; it has the capability of a wide fog pattern for personal protection; it gives the AFFF solution sufficient expansion to extinguish hydrocarbon fires.

There are occasions, however, when greater expansion rates are needed to properly apply a foam solution; polar solvent fires, using fluoroprotein foam, securing spills, etc. For these special situations a foam aeration tube can be quickly and easily attached to the combination fog nozzle to enhance the expansion of the foam solution.

244 FOAM TUBE

For adding more air to foam solution to achieve thick, wet foam blanket - Quickly attaches to SFL, SFL-G, SFL-N, and SFL-GN nozzles - Durable, lightweight Elk-O-Lite construction - Cast finish with nylon cord wrap - Length, 40 ½" - Weight, 4 ½ lbs.

246 FOAM TUBE

For adding more air to foam solution to achieve thick, wet foam blanket - Quickly attaches to 4000-02, 4000-03, 4000-10, 4000-13, SFL-B, SFL-BG, SFM, SFM-G, SM-IOF, SM-IOFG, SM-20F, and SM-20FG nozzles - Durable, lightweight Elk-O-Lite construction - Cast finish with nylon cord wrap - Length, 30¾" - Weight, 4¾ lbs.

247 FOAM TUBE

For adding more air to foam solution to achieve thick, wet foam blanket - Quickly attaches to SM-30F, SM-30FG, and DSM-30F nozzles - Durable, lightweight Elk-O-Lite construction - Cast finish with nylon cord wrap - Length, 30¾" - Weight, 4¾ lbs.



EDUCTORS

Part#	GPM	Brass	Chrome
241-N	90	----	----
241-30	30	----	----
241-60	60	----	----
241-95	95	----	----
241-125	125	----	----
241-250	250	----	----
240-60	60	----	----
240-95	95	----	----
240-125	125	----	----

FOAM TUBES

Part#
246
247

PLEASE CALL
FOR PRICING



246 w/4000-10

247 w/SM-30FG

MODEL	HOSE SIZE	MAXIMUM HOSE LAY	FLOW RATE		THREAD SIZES		LENGTH	WT. LBS.	RECOMMENDED NOZZLES FOR USE WITH EDUCTOR
			GPM	L/Min	INLET	OUTLET			
241-30	1"	150'	30	113	1½" or 1" F	1" M	8¾"	4½	SFS or SFS-G (set on 30), 4000-02 (30), SM-3F, SM-3FG
241-60	1½"	300'	60	225	2½" or 1½" F	1½" M	11¾"	9½	SFL or SFL-G (Set @ 60), 4000-10 (60),
240-60	1½"	300'	60	225	2½" or 1½" F	1½" M	17¼"	20½	4000-13 (60), SM-10F, SM-10FG, SM-10FB
241-N	1½"	200'	90	340	1½" F	1½" M	10"	5¾	SFL or SFL-G (Set @ 95), SFL-B or SFL-BG (Set @ 95),
241-95	1½"	150'	95	360	2½" or 1½" F	1½" M	11¾"	9½	SFM or SFM-G (Set @ 95), SFL-N (95), SFL-GN (95),
	1¾"	300'							
240-95	1½"	150'	95	360	2½" or 1½" F	1½" M	17¼"	20½	4000-10 (95), 4000-13 (95), SM-10F, SM-10FG, SM-10FB
	1¾"	300'							
241-125	1¾"	200'	125	475	2½" or 1½" F	1½" M	11¾"	9½	SFL or SFL-G (Set @ 125), SFL-B or SFL-BG (Set @ 125),
	2"	400'							
240-125	1¾"	200'	125	475	2½" or 1½" F	1½" M	17¼"	20½	4000-10 (125), 4000-13 (125), SM-20F, SM-20FG,
	2"	400'							
241-250	2½"	200'	250	945	2½" F	2½" M	16"	16¾	Any 2½" 250 GPM constant flow nozzle.

"Always at the Heart of the Fire Service"

Quick-Attack™ Foam Aeration Tubes

Akron Brass Quick-Attack™ Foam Aeration Tubes have been newly designed and manufactured using different materials. New tubes will now be constructed of aluminum and a lightweight durable, high strength polymer, equipped to handle day-to-day firefighting conditions. They are designed to easily and quickly clamp onto various Akron Brass nozzles.



New Model #	Old Model #	Compatible Nozzle	Year
790	755	1" (25 mm) Turbojet ®	2000-current
		1" (25 mm) Assault™	2000-current
792	766	1" (25 mm) Turbojet	1993-2000
		1-1/2" (38 mm) Turbojet	1993-current
793	768	Mid-Range Turbojet	1993-current
		Mid-Range & 2-1/2" (65 mm) SaberJet™	All
794	775	1-1/2" (38 mm) Styles 3015-3021	All
		1-1/2" (38 mm) Marauder with Molded Teeth	All
796	777	1-1/2" (38 mm) & Mid-Range Assault	All
		Wide Range Turbojet	All
		1" (25 mm) & 1-1/2" (38 mm) SaberJet	All
		Mid-Range Turbojet	Pre-1993

Inline Eductors



3060, 3095, 3125

Portable By-Pass Eductors



3062, 3097, 3127

Style	Type	Inlet	Outlet	Flow GPM	Length	Weight LBS.	Material
3060	In-Line	1 1/2" or 2 1/2"	1 1/2"	60	7 3/4" (1 1/2") 8 1/2" (2 1/2")	3 1/2	Pyrolite
3095	In-Line	1 1/2" or 2 1/2"	1 1/2"	95	same as 3060	3 1/2	Pyrolite
3125	In-Line	1 1/2" or 2 1/2"	1 1/2"	125	same as 3060	3 1/2	Pyrolite
3097	By-Pass	1 1/2" or 2 1/2"	1 1/2"	95	18"	20	Chrome

Features of In-line and By-Pass Eductors shown above

- * Infinite number of settings between 0% and 6%
- * Performs well with 75 psi and 100 psi rated nozzles
- * Detents at 1/4%, 1/2%, 1%, 3% and 6%
- * Larger, easier to read metering dial with positive position stops
- * Rated flow calibrated at 200 psi inlet pressure
- * Pickup tube of reinforced clear PVC hose to help prevent kinking
- * Ideal for training without foam
- * Retrofit kits available for old style Akron Eductors

Fol-Da-Tank Portable Collapsible Tank

Two people can unload Fol-Da-Tank from the truck and set up in less than 30 seconds. Your choice of frames include a frame that is resistance welded 14- gauge 7/8" steel tubing with a snag free finish, or a frame fabricated of aluminum square tube, which is 26% lighter than steel. Both frames utilize die cut cadmium-plated hinges, solid brass grommets and heavy duty bolts.



			Steel			Aluminum			
Cap. Gal.	Dimensions Length x Width	Model#	Wt. Lbs.	28 oz. Vinyl	22 oz. HPR®	Model#	Wt. Lbs.	28 oz. Vinyl	22 oz. HPR®
600	6'3" x 6'3"	FDT-600	95			FDT-600-ALUM	70		
1000	8'3" x 8'3"	FDT-1000	125			FDT-1000-ALUM	95		
1500	10'3" x 10'3"	FDT-1500	145			FDT-1500-ALUM	110		
2100	11'3" x 11'3"	FDT-2100	166			FDT-2100-ALUM	125		
2500	12'3" x 12'3"	FDT-2500	175			FDT-2500-ALUM	130		
3000	13'3" x 13'3"	FDT-3000	185			FDT-3000-ALUM	135		
3500	14'3" x 14'3"	FDT-3500	210			FDT-3500-ALUM	155		
4000	15'3" x 15'3"	FDT-4000	250			FDT-4000-ALUM	185		

SINGLE LANE TANKS®			Steel		Aluminum				
Cap. Gal.	Dimensions Length x Width	Model#	Wt. Lbs.	28 oz. Vinyl	22 oz. HPR®	Model#	Wt. Lbs.	28 oz. Vinyl	22 oz. HPR®
2000	14' x 8'	SLTS-2000	170			SLTA-2000 (ALUM)	130		
2500	16' x 9'	SLTS-2500	200			SLTA-2500 (ALUM)	155		

Color of 28 oz. vinyl is orange. 22 oz. HPR® is available in yellow or red, if you do not specify, we will ship yellow

*Other materials available, call for pricing

Fol-Da-Tank Self-Supporting Tank

One person can unload this Fol-Da-Tank from the truck. These self-supporting frameless portable water tanks have been designed to meet the most stringent requirements of rural/urban fire fighting. As the self-supporting tank begins to fill with water, its unique design allows it to become self-supporting automatically. Constructed from heavy duty safety orange Vinyl (PVC) with all seams welded for longer life. Includes 4 support rings and a compact storage bag. Supplied with one threaded flange coupling installed. Your choice of 1 1/2" thru 6" NST or IPT male or female (Please Specify).



Model#	Capacity Gal.	Size Open	Approximate Folded Dimensions	Weight Lbs.
SSTFD-500	500	5'0" x 6'6"	30" x 32"	50
SSTFD-1000	1000	7'3" x 8'10"	32" x 32"	60
SSTFD-1500	1500	9'2" x 11'10"	34" x 37"	75
SSTFD-2000	2000	10'0" x 12'5"	34" x 37"	75
SSTFD-2500	2500	12'0" x 13'6"	36" x 37"	95
SSTFD-3000	3000	13'0" x 14'9"	36" x 37"	105
SSTFD-4000	4000	14'0" x 16'0"	38" x 42"	110
SSTFD-5000	5000	17'0" x 19'0"	40" x 42"	130

All models have an open height of 32"

Male Dry Hydrant Adapter

Male threads complete with suction strainer, snap ring and yellow polymer cap. Adapter will glue into your PVC Elbow. You can purchase your PVC Elbows locally when you purchase your pipe.

Part #	Size	
	PVC	NST
DHM60P	6.0"	6.0"
DHM50P	6.0"	5.0"
DHM45P	6.0"	4.5"

***If ordering w/ elbow, please call for pricing**



Male Dry Hydrant Adapter

Male threads complete with suction strainer, snap ring and red aluminum cap. Adapter will glue into your PVC Elbow. You can purchase your PVC Elbows locally when you purchase your pipe.

Part #	Size	
	PVC	NST
DHM60A	6.0"	6.0"
DHM50A	6.0"	5.0"
DHM45A	6.0"	4.5"

***If ordering w/ elbow, please call for pricing**



Female Dry Hydrant Adapter

Female threads complete with suction strainer, snap ring and red aluminum plug. Adapter will glue into your PVC Elbow. You can purchase your PVC Elbows locally when you purchase your pipe.

Part #	Size	
	PVC	NST
DHF60A	6.0"	6.0"
DHF50A	6.0"	5.0"
DHF45A	6.0"	4.5"

***If ordering w/ elbow, please call for pricing**



*Due to the volatility in the market, our pricing is, unfortunately, subject to change without notice. Please check our website or call us for the most up to date pricing.

DRY HYDRANT ACCESSORIES

Part #	Size	Description
PVCSF60	6.0"	Horizontal PVC Strainer with Back Flushing Cover
PVCS60	6.0"	Horizontal PVC Strainer with Fixed Cover
PVCS80	8.0"	Horizontal PVC Strainer with Fixed Cover
PVCSF80	8.0"	Horizontal PVC Strainer with Back Flushing Cover
DHBS80	8.0"	PVC Barrel Strainer
DHLL60	6.0"	Dry Hydrant Low Level PVC Strainer
TDS6	6.0"	Shallow Water Strainer (Tear Drop Style)
SSC60	6.0"	Strainer Support Clamp
SSC80	8.0"	Strainer Support Clamp
DHS	12" x 18"	Reflective Dry Hydrant Sign
DHT6-001	6.0"	Full Time In Line Swivel (allows 360° rotation of Dry Hydrant)

VANGUARD POWERED HIGH POWER VOLUME PUMP

This pump equipped with a Vanguard motor is available with one (PFP-18hpVGD-1D) or two delivery outlets (PFP-18hpVGD-2D), depending on your needs. The engine and pump are mounted on a steel protective frame with folding handles.



PFP-18hpVGD-1D Shown

CET FIRE PUMPS VANGUARD 18 HP

PFP-18hpVGD-1D

PFP-18hpVGD-2D

DESCRIPTION

- Air cooled 18hp Vanguard, OHV, V-Twin
 - Centrifugal pump with brass impeller and aluminum casing.
 - Mechanical seal and wear ring
 - Stainless steel shaft pump
 - 1 1/2" discharge with 1/4-turn ball valve
 - 2 1/2" suction
 - Compact (20" x 23" x 23" H)
 - Weight : 165 lbs.
 - Exhaust priming system up to 20 ft suction head
 - One battery 12 volts
 - 100 watt alternator
 - Protective rack with 4 folding handles (option)
 - Exhaust pipe guard
 - Discharge pressure gauge.
 - 6 gallons (22 l) detachable fuel tank. The fuel tank is made from plastic
- -1D has one 2 1/2" (65 mm) delivery outlet with 1/4-turn ball valve
 - -2D has two 2 1/2" (65 mm) delivery outlets with 1/4-turn ball valve
 - One 4" (100 mm) suction inlet

INCLUDED ACCESSORIES

- Swivel spotlight
- 36 watt alternator
- Pressure gauge
- Low oil alert
- 12 volt battery

PERFORMANCE

- 250 GPM @ 50 PSI
- 150 GPM @ 100 PSI
- 100 GPM @ 150 PSI
- 25 GPM @ 200 PSI

***The entire line of
CET PUMPS is available -
Visit our website or
call for details!***



Fire-End Part No.	Size	Description	UL Rating	Wt. lbs.
CHIEF CROKER WATER				
4202	2.5 Gallon	Water Pressurized (shipped empty)	2A	7.5
CHIEF CROKER ABC DRY CHEMICAL				
4002	2.5lb.	with Nozzle & Vehicle Bracket	1A:10B:C	5.5
4005	5lb.	with Hose & Horn, Alum. Valve	2A:10B:C	10.5
4010	10lb.	with Hose & Horn, Alum. Valve	4A:80B:C	19
4020	20lb.	with Hose & Horn, Alum. Valve	10A:120B:C	38
CHIEF CROKER REGULAR DRY CHEMICAL				
4302	2.5lb.	with Nozzle & Vehicle Bracket	10B:C	5.5
4305	5lb.	with Hose & Horn, Alum. Valve	10B:C	9.25
4310	10lb.	with Hose & Horn, Alum. Valve	60B:C	18
4320	20lb.	with Hose & Horn, Alum. Valve	120B:C	38
CHIEF CROKER CARBON DIOXIDE				
4405	5 lb.	Aluminum with Swivel Horn	5B:C	13.1
4410	10lb.	Aluminum with Hose & Horn	10B:C	28.25
4415	15lb.	Aluminum with Hose & Horn	10B:C	37.75
4420	20lb.	Aluminum with Hose & Horn	10B:C	50.75
CHIEF CROKER SPECIAL PURPOSE				
4206	2.5 Gallon	Water Mist	2A:C	8
4834	6 Liter	Wet Chemical (for commercial kitchens)	2A:20BC:K	22.5
4830	30lb.	Sodium Chloride Dry Powder	(Class D)	59
CHIEF CROKER HALOTRON I				
4132	2.5lb.	with Nozle & Vehicle Bracket	2B:C	5.25
4135	5lb.	with Nozzle & Vehicle Bracket	5B:C	9.5
4137	11lb.	with Hose & Horn, Brass Value	1A:10B:C	22.5
4139	15.5lb.	with Hose & Horn, Brass Valve	2A:10B:C	27.5

BRACKETS

- 809 Vehicle Bracket
- 810 Vehicle Bracket

APPLICABLE EXTINGUISHER

- 4010, 4310, 4405
- 4202, 4020, 4320, 4410, 4415

All fire extinguishers except the models 4202 and 4206 will incur a hazardous material handling charge.

*Due to the volatility of metal prices, all prices are subject to change

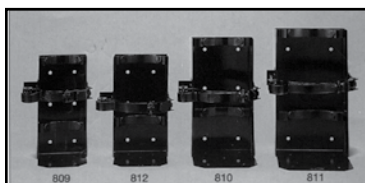

SUPER VAC V18 VALOR SERIES



THE MOST VERSATILE BATTERY FAN HAS ARRIVED!

V18-BD WITH DEWALT LITHIUM ION BATTERY OR V18-BL WITH MILWAUKEE RED 18V BATTERY

YOUR BATTERY ARSENAL JUST GREW!

Never in firefighter history has one fan worked with your department's other battery-operated tools. Until now. The all-new Super Vac variable-speed battery fan, equipped with dual DeWalt or Milwaukee batteries, is the most swappable PPV interface on the market. Finally, the industry can turn to a fan with a trusted battery name that pairs with Super Vac's dependable history.

Featuring:

- Curved Handle
- Compact, Roll-Cage Frame
- Stream Shaper Guard
- Polymer Blade
- Optional Shore Power
- Standard Flat-Proof Rubber Tires
- Only 46 lbs. and Still Super Vac Tough
- AMCA Certified Up to 45 minutes of Run Time*
- 180° of Separation as shown below:



**New 20" Fan also available - Call for pricing or check our website (V20).*



Valor Series DeWalt Battery PPVs

- V16-BD-SP 16" PPV, with Shore Power, No Battery, No Charger
- V16-BD-09-AC-SP 16" PPV, 2x 9 Ah Bat., 2x AC Chargers, Shore Power
- V16-BD-12-AC-SP 16" PPV, 2x 12 Ah Bat., 2x AC Chargers, Shore Power
- V18-BD-SP 18" PPV, with Shore Power, No Battery, No Charger
- V18-BD-09-AC-SP 18" PPV, 2x 9 Ah Bat., 2x AC Chargers, Shore Power
- V18-BD-12-AC-SP 18" PPV, 2x 12 Ah Bat., 2x AC Chargers, Shore Power

Valor Series Milwaukee Battery PPVs

- V16-BL-SP 16" PPV, with Shore Power, No Battery, No Charger
- V16-BL-08-AC-SP 16" PPV, 2x 8 Ah Bat., 2x AC Chargers, Shore Power
- V16-BL-12-AC-SP 16" PPV, 2x 12 Ah Bat., 2x AC Chargers, Shore Power
- V18-BL-SP 18" PPV, with Shore Power, No Battery, No Charger
- V18-BL-08-AC-SP 18" PPV, 2x 8 Ah Bat., 2x AC Chargers, Shore Power
- V18-BL-12-AC-SP 18" PPV, 2x 12 Ah Bat., 2x AC Chargers, Shore Power

For Negative Tilt Attacks



For Positive Tilt Attacks



For Manhole Attacks



For Attic Attacks





ELECTRIC SMOKE EJECTORS

Smoke ejectors come complete with all of the features that make Super Vac the most respected name in emergency ventilation. The heart of these units is the patented, cast aluminum, 4 blade, recurve propeller designed specifically for smoke ejection. Poured in Super Vac's foundry of the toughest aircraft alloys, the blade is the perfect combination of a low noise, high output design. The power comes from your choice of totally enclosed (S) or hazardous location (SE or E) electric motors. All motors come with a factory approved two year warranty and will run on 110 or 220 Volts. The rest of the fan is covered by Super Vac's five year warranty. The Super Vac smoke ejector is a proven performer in the toughest situations. All Super Vac smoke ejectors feature a square construction for strength and stability. With handles on every corner, these units are easy to handle and can be stacked or hung using Super Vac accessories. These units are designed to accept spiral or "L" ducting with Super Vac adapters. The textured, chip resistant powder coating is baked on for a finish that is as tough as the rest of the fan. All Super Vac ejectors feature third party verified shroud airflow tested to AMCA (Air Movement and Control Association) Standard 210-99. For the ultimate in spark resistant construction, units with a hazardous location motor and optional aluminum housing are classified Type A (highest degree of spark resistance) by AMCA 99-0401.

MODEL#	*MOTOR	H.P.	START	WATTS>RUN	HEIGHT, WIDTH, DEPTH	WT.	SHROUD<G.F.M.>VENTURI
P124S	TEAO	1/2	2000	800	15.5" x 15" x 13"	40#	2750 3700
P124SE	HAZ	1/2	2000	800	15.5" x 15" x 13"	42#	2750 3700
P164S	TEAO	1/3	2000	700	19.25"x18.75"x13"	44#	3200 5200
P164SE	HAZ	1/3	2000	700	19.25"x18.75"x13"	49#	3200 5200
P200S	TEAO	1	4000	1500	25.5"x24.75"x16.25"	85#	6700 9500
P200SE	HAZ	1	4000	1500	25.5"x24.75"x16.25"	93#	6700 9500
P244S	TEAO	1-1/2	6000	2100	28.5"x28"x18.75"	110#	8600 10800
P244SE	HAZ	1-1/2	6000	2100	28.5"x28"x18.75"	115#	8600 10800
HF164	TEAO	1-1/2	6000	2100	19.5"x18.75"x16"	44#	4950 9620
HF164E	HAZ	1-1/2	6000	2100	19.5"x18.75"x16"	49#	4950 9620

*MOTOR INFORMATION: TEAO TOTALLY ENCLOSED AIR OVER MOTOR
 HAZ EXPLOSION PROOF MOTOR FRAME CONSTRUCTION
 MOTOR ALSO AVAILABLE WITH 230/460 VOLT 3 PHASE MOTOR
 NOTE: HAZARDOUS LOCATION MOTORS ARE U.L. RATED, BUT NOT THE ENTIRE FAN ASSEMBLY.

12" MODEL P124 ELECTRIC



The P124 is designed for high powered air movement in a compact sized fan. Turning at 3450 rpm, the fan is small but mighty. Perfect for the department that wants to eject smoke and have a small unit for confined space ventilation.

24" MODEL P244 ELECTRIC



The P244 is the largest smoke ejector available. This fan will quickly ventilate larger buildings and residences. Perfect for the department that has a mix of residential and mid-sized commercial buildings in their response area.

16" MODEL P164 ELECTRIC



The P164 is the most popular unit in the fire/rescue service. It is the perfect combination of high airflow and easy to handle size. Perfect for the department that wants a great, all-around fan.

Note: Requires a 20 amp circuit to start and run.

16" HIGH SPEED HF164



Combined with the tilt frame, the HF164 becomes the most versatile ventilation system in the industry.

The HF164 is the most powerful 16" fan in the industry. It can easily be used for both negative and positive pressure ventilation. Running at 3500 rpm, it has the power to force or pull air deep into a structure or underground vault. Perfect for the department that wants a powerful fan for negative, positive pressure, or large confined space ventilation. Note: Requires a 20 amp circuit to start and run.

20" MODEL P200 ELECTRIC

The P200 is capable of bigger ventilation tasks and higher airflows. Its 1 horsepower motor is the largest available that will run off the standard 15 amp household circuit. Perfect for the department that has a mix of residential and commercial buildings in their jurisdiction.



Combined with the tilt frame, the HF164 becomes the most versatile ventilation system in the industry.



GAS POSITIVE PRESSURE VENTILATORS

Super Vac is the leader in airflow and compact fan design for gasoline powered PPV's. The heart of all these units is the cast aluminum 7 blade airfoil propeller designed specifically for use on PPV fans. Poured in Super Vac's foundry of the toughest aircraft alloys, the blade is the perfect combination of a low noise, high output design. The power comes from your choice of Honda (-H) or Briggs (-B) engines. These engines come with a factory approved two year warranty. The rest of the fan is covered by Super Vac's five year warranty. The direct drive system eliminates belts and pulleys for years of trouble free operation. Super Vac PPV's all feature a cart style design with rear mounted pneumatic tires and a flip-up or pull-up full height, full width handle for easy maneuverability. They feature the exclusive Super Vac lever action tilt, with positions of 20°, 10°, 0° and -10° and a locking step brake to make setup lightning fast. The textured chip resistant powder coating is baked on for a finish that is as tough as the rest of the fan. All Super Vac PPV's feature third party verified airflow tested to AMCA 240-96 and can easily be used with other Super Vac fans in the "V" attack configuration.



Pneumatic tires mounted on the rear of all PPV's allow fans to easily move over obstacles or up stairs.



Step brakes easily lock or unlock tires in one motion.

18" MODEL 718G4



The 718 is designed to compact dimensions that fit the tightest pumper compartments. They feature the highest horsepower in their class for maximum airflow. Perfect for the department buying their first PPV or outfitting their entire fleet of engines.

24" MODEL 724G4



The 724 features larger engines and higher airflow than other fans. These units are serious work horses to make quick work of ventilating larger occupancies. Perfect for the department with a mixture of residential and mid-sized commercial structures in their district.

20" MODEL 720G4



The 720 is the perfect combination of small size and high power. They also feature the highest horsepower in their class and the exclusive roll cage frame design. Perfect for the department with a mixture of residential and small commercial structures in their district.

30" MODEL 730G4



Super Vac's 730 is the largest and most powerful, portable PPV available. It is capable of ventilating warehouses, high-rise buildings, and large retail outlets. Perfect for the department with larger commercial and public structures in their response area.

MODEL#	H.P.	HEIGHT, WIDTH, DEPTH	WEIGHT	RPM	SET BACK	ANGLE	CFM
718G4-B	6.0	18.75"X22.00"X20.75"	79#	3770	8'	18°	15,350
718G4-H	6.5	18.75"X22.00"X20.75"	82#	3535	6'	18°	15,590
720G4-B	6.0	25.50" x 24.50" x 18.75"	89#	3385	6'	19°	18,060
720G4-H	6.5	25.50" x 24.50" x 18.75"	92#	3350	6'	19°	18,580
724G4-B	9	27.75" x 28.50" x 20.50"	119#	3245	6'	18°	21,100
724G4-H	9	27.75" x 28.50" x 20.50"	133#	3435	8'	18°	20,920
730G4-H	13	38.75" x 37.00" x 27.50"	163#	3220	10'	9°	26,730



Door Bar

Our Door Bar allows you to hang a Super Vac with hangers, in any doorway at the height you choose. It only weighs 13 pounds, it's extremely easy to install and it releases instantly with a handy trigger. Door Bar extends from 27" to 40", an optional door bar extender will add 20".

Model

DB Door Bar



Hanger

These hangers allow you to put your Super Vac almost anywhere; on doors, ladders, windows, casements, archways etc. Used in conjunction with the Door Bar, they permit placing at any height. Please specify fan number when ordering. Consists of two hooks and webbed strapping.

Model

HR (Specify fan model #)



Running Board Mounts For Gas Ventilators

These mounts provide a secure hold for the protection of your equipment and personnel. Please specify fan number when ordering.

Model

RBM - (Specify fan model #)



Running Board Mounts For Square Ventilators

These mounts provide a secure hold for the protection of your equipment and personnel. Please specify fan number when ordering.

Model

RBM - (Specify fan model #)



GP164S 16" Square Gas Fan

Factory ready to accept duct on input or output side.

Model HP Cycle

GP164S 3 2

Dimensions

13"x19.5"x20"

Weight 47#

CFM

4200 Shroud

5600 Venturi



Battery Saw Conversion Kit

Convert your ordinary Makita, DeWalt, or Milwaukee chain saw into a Heavy Duty Rescue Saw.

Kit Contents

- SV375-16 Carbide tipped chisel chain
- SV530-16 Guide Bar 16"
- SV780-16 Depth Gauge

Compatible with

Makita:

XCU07, XCU04, XCU03

DeWalt:

DCCS670B, DCCS670X1

Milwaukee:

2727-20, 2727-21HD

Model

SV789-16 Battery Saw Conversion Kit



Cloud 9 Smoke Machine by Super Vac.

The Super Vac Cloud 9 Smoke Machine includes everything you need to get started. The only additional item you need to purchase is extra oil based smoke fluid. The included gas cylinder is shipped empty. You can have it refilled at any local shop that services fire extinguishers.

Price includes the following:

- Roll cage frame, pneumatic tires and tilt-up handle
- Remote control with 50' extension
- Gas regulator
- Gas hose, 16"
- 5 lb. CO2 cylinder (shipped empty)
- .60 gallon oil base fluid (enough for 1 tank full)

Model Number

S-975 Cloud 9 Smoker complete, 115 VAC

S-900 (6) x 0.6 gallon bottles oil based fluid



Figure 1



Figure 2



Spiral Duct (with storage bag)

This is the highest quality duct made, with heavy duty wear strips and two-ply construction, ideal for moving large quantities of air into hard to reach places. Available with an adapter as shown (AD). Extension pieces also available without adapter (BC1). Spiral duct may be used on the intake or discharge side of fan. Fan shown not included.

Model	Dia.	Extended	
		Length	Duct with Adapters
12x20AD	12"	20'	
16x20AD	16"	20'	
20x20AD	20"	20'	
24x20AD	24"	20'	

Translucent "L" Duct

The "L" duct is an extremely useful duct that is held open by air pressure from the fan. It folds up to take very little space when not in use. Once deployed, men and equipment can pass by easily in cramped spaces by simply collapsing the duct. (Figure 1) shown attached to an adapter that clips easily onto a fan. Light is able to pass thru the reinforced translucent vinyl. (Figure 2) shown strapped inside the duct allows the vertical leg to be shortened to form a 90 degree bend.

Model	Dia.	Hor. Leg	Vert. Leg
LD 12-3X8	12"	3'	8'
LD16-3X8	16"	3'	8'

Tilt Frame For 12" and 16" Ventilators

The bracket easily retrofits onto your existing 12" & 16" Super Vac to allow tilting in any direction. From straight up for blowing into an attic access hole, to straight down for blowing into a man hole... this bracket allows you to quickly set up your fans. Can be ordered with new fans or as a kit to easily retrofit to existing fans.

Model	Fan Size
TF124	12"
TF164	16"

Duct Extensions

12x20BC1	12"	20'
16x20BC1	16"	20'
20x20BC1	20"	20'
24x20BC1	24"	20'

Fan Covers

Vinyl fan covers available in red or yellow. Specify fan model number and color of cover when ordering

12" thru 24" (Specify fan model)



PARTNER® K-12 FD Rescue Saw Package K12FDPKG

The "Package" Model is equipped with the following:

- NIGHT EYE - A bright LED light that provides illumination on a smokey roof or while cutting a roof at night.
- CARRY SLING - A heavy duty, adjustable shoulder carry strap with reflective stripe.
- CARBIDE TIP BLADE - Your choice of a 24-tip (12-inch) or 30-tip (14-inch) wood cutting carbide tip blade.
- FLASHING LIGHT - A red LED flasher mounted to the top of the saw to help locate on a smokey roof.



PARTNER® FD-770

K-770-14"x30T

K-770-12"x24T

The PARTNER® K-770 is the replacement for the K-760. It is offered with a 14" guard and a 12" guard. The K770 12" is ideal for forcible entry.

It is also great for roof cutting due to its unique power source and the use of CHOPPER blades. This saw consists of five horsepower and weighs less than 20-pounds. This light weight saw is a perfect choice for any Fire Department operation.



Super Vac Power Pro Cutoff Saw SVC4

The SVC4 is an update to the popular SVC3. Smaller and lighter, the design improves mobility and the 2 stroke engine turns the same 14" diamond blade cutting wheel at 500 more RPM. These high performance saws are designed for the fire and rescue service and proves to cut through concrete, asphalt, stone, and more with ease.

The SVC4 is designed from the ground up with many special features customized for the fire/rescue service including a D-ring pull handle (large enough for thick rescue gloves), the ultimate debris removal system and filters a flow of exhaust against dust direction for cleaner/ safer operations.



Super Vac Rescue Saws

SV3-16 16"

SV3-20 20"

- Shindaiwa 757 rugged power head
- Output / Speed - 15.6 Hp / 13,000 rpm
- Self cleaning Carbide Chisel Chain, .404 Dual Raker
- Depth Gauge - Full Safety Cover, quick adjust/removal
- Air Filter - 128 square inches / covered and protected
- Sprocket Nose - High Alloy, 8 rivet nose

The Super Vac Rescue Saws: Combining rugged construction, smooth performance and raw power, the lightweight Super V3 Power Pro is the perfect solution for your rescue saw needs. Designed for maximum versatility, (roof operations, to rapid intervention teams, to clearing fallen trees and cutting shoring) the Super V3 will have your department ready for the next call. Comes complete with a full safety cover/depth gauge, a carbide chisel chain, skrench tool and a powerful Shindaiwa 757 engine. The Super V3 is always ready to roll!



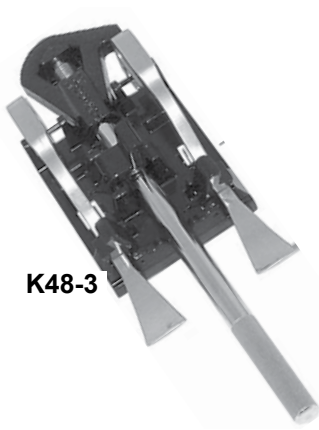

K48-3

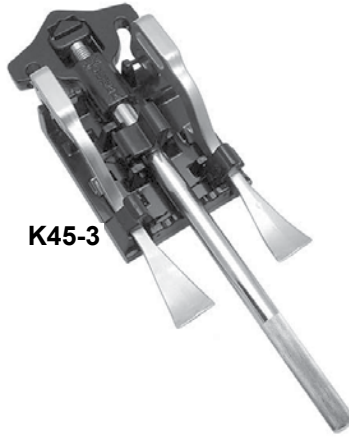

K45-3

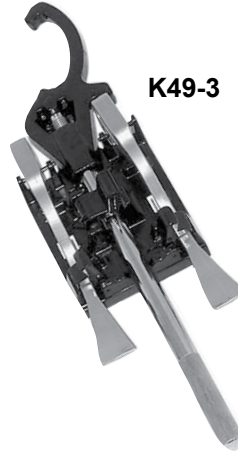

K49-3



KS34

- K48-3** Triple Holder Set, (1) K07 Hydrant Wrench & (2) 7113 Universal Spanners
- K45-3** Triple Holder Set, (1) K05 Hydrant Wrench (Double) & (2) 7113 Universal Spanners
- K49-3** Triple Holder Set, (1) K08 Storz Hydrant Wrench & (2) 7113 Universal Spanners
- KS34** Storz Holder Set, (4) KS3 Storz Spanner Wrenches

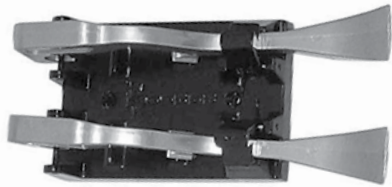

K46-2 Double Holder Set
Complete with (2) 7113 Universal Spanner Wrenches



K07 Adjustable Hydrant Wrench (Single)
For pentagon heads up to 1 3/4" and square 1 1/4" - Single hook spanner head fits 3/4" to 6" rocker lug or pin lug fittings



K05 Adjustable Hydrant Wrench (Double)
For pentagon heads up to 1 7/8" and square 1 1/2" - Double hook spanner head fits 3/4" to 6" rocker lug or pin lug fittings
-Replaceable jaw



K08 Adjustable Storz Hydrant Wrench
For pentagon heads up to 1-3/4" and square 1-1/2" - Storz spanner combination fits 4" to 6" storz; plus 3/4" to 6" rocker lug and pin lug fitting



KS3 Storz Spanner Wrench
One end fits 4" thru 5" Storz, other end is a universal spanner.



7113 Universal Spanner Wrench
(A-2019) Fits 3/4" to 3" rocker or pin lug.

*Due to the volatility in the market, our pricing is, unfortunately, subject to change without notice. Please check our website or call us for the most up to date pricing.

Firehooks Pro Bar, 30"

PB-30 30"

Forcible entry (halligan type) tool made from dropped forged aircraft steel. Preferred bar of the FDNY. All pro bars are nickel plated.



PB-30

Firehooks Wide-Adz Pro Bar

WA-PRO-30 30"

A new type of Pro-Bar Halligan Tool... One-piece dropped forged with an added feature. An additional 1" to the 2" Adz for a total of 3" in width! This modification makes inward forcible entry a breeze. Great for overhauling debris with the wide Adz. Increases the strike surface.



WA-PRO-30

Firehooks Dynamic Trio

DT-3

Includes: 8 lb Force Axe, Pro-Bar 30" & Marrying Strap



DT-3

Firehooks Eight Maul

8-M28-B

A Sledge hammer with a 28" fiberglass handle for forcible entry. Protected handle for overstrike and self extinguishing celtex grips. The 28" long handle allows this tool to fit any truckman's belt.



8-M28

Firehooks Talon Hook

TAL-6

A special lightweight all steel 6' hook with Claw Fork and NY Roof Hook" style head. Celtex non-slip grip. Available in other sizes, call for pricing.



TAL

Firehooks Master Tool Bracket/Holding Bracket

HB-1

Made especially for Fire Hooks tools. Sold as single bracket.

*Shown with tool not included



HB-1

MAXXIMUS Forcible Entry Halligan Bar

The MAXXIMUS is the next generation of forcible entry bars. It is the ultimate Halligan bar and is lighter than the Pro-Bar. The Maxximus has a unique T.P.R. grip for a sturdy handle while using this tool. Other features include a depth gauges on the adz and the fork eliminate guess work.

- One piece drop forged forcible entry tool
- Made of 4140 chrome vanadium steel
- A completely "tuned" Halligan
- 2 3/4 inch wide adz for gapping doors
- Rex lock pulling feature on the fork
- Square legs on the fork for striking in tight spaces
- Thinner fork and adz than any bar on the fire market
- Depth gauge markings on both adz and fork
- Molded T.P.R. grip to lessen slippage
- Standard 30-inch length.
- Nearly 2 lbs lighter than the Pro-Bar Halligan

MX-MOD has all of the same features as MX, but with a 2 inch wide adz

MX-REX has all of the same features as MX, but with a Rex lock pulling feature on both fork and adz

Model Number

MX

MX-MOD

MX-REX

MAXXIMUS

MAXXIMUS-MOD

MAXXIMUS-REX



MX



MX-REX



**MX-MOD
Head**

Firehooks 8 LB. Force Axes

FA-8 8lb. Flat Fiberglass

FAP-8 8lb. Pick Fiberglass

The ultimate tool for forcible entry, perfectly balanced to lay correctly in the hands for that short strike zone on an iron or unlimited padlock breaker. Large, oversized head makes the strike zone more accurate and easy to hit. Cutting edge annealed to keep its edge longer.



**FA-8
FAP-8**

Axes

A2001 6 lb. Flat Wood

A2002 6 lb. Pick Wood

A2003 6 lb. Flat Fiberglass

A2004 6 lb. Pick Fiberglass

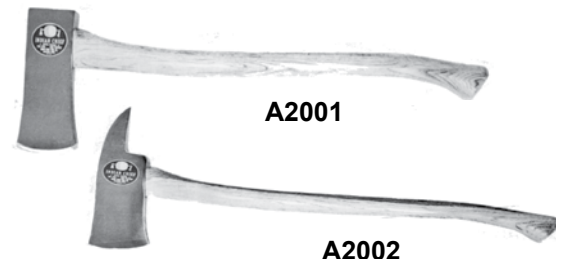

A2001

A2002

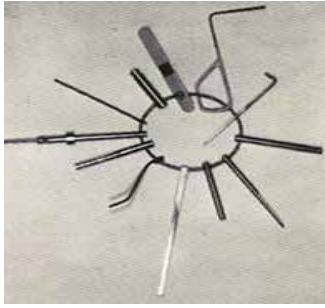

Elevator Keys EKS-12

Equipped with 12 keys attached to a 5" ring. Manufactured to conform with the majority of elevator manufacturer access keys. Keys are hard anodized in gold plate to resist rust.



Rex Tool REXT

A lock pulling tool, shaped like a "U" with sharp tapered blades that bite into lock cylinders of all shapes and sizes. Extra leverage and original head design provide the mechanical advantage to pull well secured lock cylinders. Opposite chisel end is used to drive rim locks after cylinders are removed.



Officer's Tool Kit OTK-16

Made of high strength steel with the head welded to the shaft. The shaft is covered with a non-slip gripping surface. The shaft end of the tool is formed into a pry bar capable of slipping into tight spaces. The head of the tool has a flat driving surface, with an A-type lock puller machined into the adz of the blade. The complete "thru-the-lock-kit" available with the tool contains the officer's tool, a double ended "key" tool and shove knife.

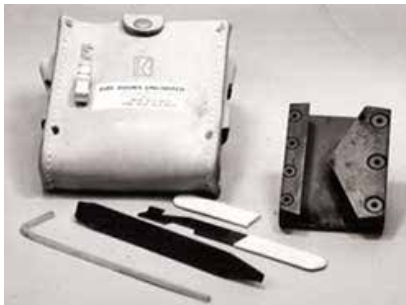

K-Tool Kit KTK

A tool designed (by a FDNY Fire Lieutenant & licensed locksmith) to pull all types of lock cylinders (rim or mortise) from the various glass type or solid doors. The K-Tool Kit consists of K-Tool, Operation Manual, Set of Key Tools, Shove Knife & Leather Pouch



R-Tool Kit RTK

A tool designed to pull all types of lock cylinders too large for the K-Tool unit (above), such as locks that extend out from the door and 1-inch round are easily pulled with the R-Tool. The R-Tool Kit consists of R-Tool, Set of lock tool keys, Carrying bag & Shove knife

Hydra-Ram

The Hydra-Ram is the first and only one piece integrated hydraulic forcible entry tool. The Hydra-Ram has a maximum thrust opening of 4 inches. There are no hoses or auxiliary pumps to leak or trip on. The Hydra-Ram is truly a one man operation, since the whole unit is in the hands of the user.

The Hydra-Ram weighs only 11 lbs. and is only 13 inches long. Great for the narcotics officer, it can be carried under the coat like a weapon.

No need to worry about maintenance or leaking fluids. The Hydra-Ram uses aircraft seals of triplex quality. The hydraulic fluid is non-flammable, non-toxic and non-freezing. The jaws are made of special stainless steel of 220,000 tensile strength. 10,000 lbs. of force is acquired at 138 lbs. pressure at the handle. While other units may take 30 to 40 strokes on the pump to gain full extension, the Hydra-Ram does it in 8 strokes. The Hydra-Ram can be used in any position, even upside down without any effect on its operation.

The Hydra-Ram II is the same as the Hydra-Ram except it has a maximum thrust opening of 6 inches, weighs 13 lbs. and is 15 inches long. The Hydra-Ram units includes a mallet and heavy duty Cordura bag.

Model Number	Length
HR-1	4" thrust opening
HR-2	6" thrust opening

Hydrant Wrench

HW-1

Adjustable, cadmium plated celtex grips for safety

Wedge, Aluminum

WEDGE

A positive aid for forcible entry made of 6061-T6 aluminum. The 7 oz wedge has a hole to fit a halligan spike and an 11 in. bungee cord attachment.

Spring Loaded Punch

SP-1

For Window Removal. Simple, Fast, and Safe.

"The Original" CAN HARNESS

CH-312

Held in place by (2) 3 inch Velcro straps and a safety strap with a "D" ring, which goes through a hanging bracket on the can. The can may then be carried either horizontally (shown below) or vertically. Can be used on all extinguishers.

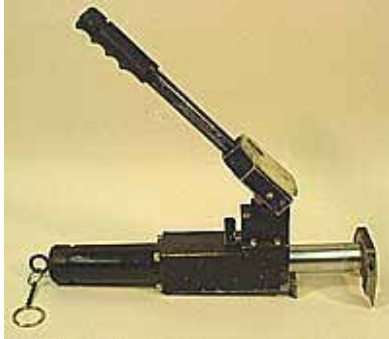



National Hook Fiberglass Ash Core

Part #	Length
NHF-4'	4'
NHF-5'	5'
NHF-6'	6'
NHF-8'	8'
NHF-32"W/D	32"
NHF-40"W/D	40"

This model is an excellent value. It is durable and dependable. Made for those who have economy in mind. An excellent choice. Diameter 1 1/4"



New Yorker Fiberglass Ash Core Super

Part #	Length
NYFG-4'	4'
NYFG-5'	5'
NYFG-6'	6'
NYFG-8'	8'
NYFG-32"W/D	32"
NYFG-40"W/D	40"

A yellow fiberglass pole with ash core, a malleable iron head, Celtex grips and a ram knob on the end. Diameter 1 1/4"



New York Roof Hook - Steel Shaft

Part #	Length
RH-4'	4'
RH-6'	6'
RH-8'	8'

Developed by the New York City Fire Department's R&D department. Features an all purpose head, aircraft steel shaft, chisel end, and Celtex grips. The chisel end is used as a prying tool for scuttle hatches and roof doors. The short lengths are for going up fire escapes and scuttles to the roof.



Boston Rake Hook - Steel Shaft

Part #	Length
BRST-4'	4'
BRST-5'	5'
BRST-6'	6'

Presently in use by the Boston Fire Department. On the head we have forged the Boston design out of carbon steel joining it to a stainless steel wear sleeve. Steel pole standard with pry end.



Newark 44

Part #	Length
NWK-44	44"

Combination forcible entry and overhaul. It has the adz and spike of the pro bar on one end and the roof hook end on the other.



Farr Barr

Part #	Length
FB36	36"
FB48	48"

A new and innovative design of a combination ROOF HOOK and the Fork End of a PRO-BAR (Halligan). This tool comes with Celtex grip, two(2) welded rings, and reflective shoulder strap.

*Includes "D" Handle

Many other lengths and configurations available - call for pricing



Flamefighter Pike Pole

Part #	Length
PP3	3'
PP4	4'
PP6	6'
PP8	8'
PP3D	3'
PP4D	4'

All Pike Poles have a round fiberglass handle with a plastic core for added stability, maximum strength, and minimum weight. The outside diameter of the handle is 1-1/4".



Flamefighter Trash Hook

Part #	Length
TH4D	4'
TH6D	6'
TH8D	8'

The standard pole with a Trash Hook and "D" style handle. The handle is held on with two spring pins and epoxy.



Flamefighter Dry Wall Hook

Part #	Length
DWH3D	3'
DWH4D	4'
DWH6D	6'
DWH8D	8'

The head of the drywall hook is fabricated from 3/16" plate steel parts that are formed and then welded into a solid structure, which results in a stronger and lighter head.

*Includes "D" Handle

Many other lengths and configurations available - call for pricing

FLAMEFIGHTER TOOL KITS

Flamefighter Tool Kits

These Roof and Salvage Kits are excellent for fire apparatus with limited space.

BP Roof Kit

- 1- 3' Pike Head
- 1- 3' Trash Hook
- 1- 3' D Handle
- 1- 4' extension pole

BP Salvage Kit

- 1- 3' Dry Wall Hook
- 1- Squeegee
- 1- Square Nose Shovel
- 1- Push Broom
- 2- 4' extension handles w/ Rubber Grip
- 1- 4' extension pole





Streamlight Vantage™

Streamlight Vantage® LED... Helmet-Mounted Tactical Light!

HELMET-MOUNTED TACTICAL LIGHT *The solution to firemen's hands-free lighting needs. Compact, powerful, shock-proof, and virtually indestructible!*

- Lightweight, compact, low profile design easily attaches/detaches above or below brim on fire helmets, industrial helmets and hard hats
- C4® LED delivers 7,000 candela peak beam intensity; 115 lumens; 167 meter beam distance
- Run 6 hours to the 10% output level
- Features an ultra-bright blue taillight LED
- IPX7 waterproof to 1 meter for 30 minutes
- Uses two 3V CR123A lithium batteries (included)
- For every red National Fallen Firefighter Foundation Vantage® sold, Streamlight will donate to the National Fallen Firefighter Foundation.



- 69140 Black
- 69157 Red



Streamlight Vantage™ II

Streamlight Vantage® II LED... Ultra Compact Fire Helmet Light!

It's compact, powerful, shock-proof, and virtually indestructible!

- High and low modes: High: 350 lumens; 118m beam; runs 2.25 hours; 3,500 candela
Low: 135 lumens; 80m beam; runs 5 hours; 1,700 candela
- Safety features include a blue taillight
- Durable aluminum construction that can take a beating from heat and smoke; Boro Float glass lens
- Reflective strips on side of switch housing
- Uses one CR123A lithium battery (included)
- IPX7 waterproof to 1 meter for 30 minutes
- Lightweight at 3.65 oz

- 69331 Black



Streamlight Vantage® 180

Streamlight Vantage® 180: Helmet/Right-Angle Multi-Function Flashlight

Giving you the ultimate versatility in a firefighter's light, the Vantage 180 goes instantly from a helmet light to a handheld light to a right-angle light.

Lightweight and compact, the VANTAGE® 180 is designed to easily attach above or below full brim Fire and Industrial helmets. The VANTAGE® 180 features a C4®LED main light combined with an ultra-bright blue LED safety tail light or a white safety flood down light mode automatically selected with the rotation of the head. The VANTAGE® 180 is powered by lithium batteries and features the latest in C4® LED technology.

- High-impact, "super-tough" nylon chemically-resistant engineering polymer construction
- Integrated multi-function stainless steel pocket clip for a variety of attachment methods
- Turnout gear attachment hook
- Includes "quick release" helmet bracket and hex key
- IPX7 waterproof to 1m for 30 minutes; 1m impact resistance tested



- 88901 Orange
- 88903 Black



Streamlight PolyTac®
Helmet Lighting Kit

Streamlight PolyTac® Helmet Lighting Kit

Universal lighting kit fits both traditional and modern style firefighting helmets. It is a low-profile, light-weight, economical alternative for securely mounting a flashlight to almost any style helmet.

- C4® LED technology within a parabolic reflector produces a concentrated beam with optimum peripheral illumination
- TEN-TAP® Programming: Choice of three operating modes
- Solid State power regulation provides maximum output throughout battery life
- High-impact, super-tough nylon polymer for exceptional durability and a superior grip texture to provide a comfortable but slip-resistant feel
- IPX7 waterproof to 1 meter for 30 minutes
- Uses two 3V CR123A lithium batteries (included)



- 88854 PolyTac Helmet Lighting Kit, Yellow

Streamlight® Survivor® LED

...One of the brightest, right-angle LED flashlights in the world!

The redesigned Survivor features a low-profile bezel that doesn't interfere with gear and equipment. The light now comes with two optional Smoke Cutter® plugs that allow you to customize the beam to your preference without changing the light's output.

- C4® LED, shock-proof with a 50,000 hour lifetime.
- Unbreakable polycarbonate lens w/ silicone anti-scratch coating assembled in a heavy-duty bezel, O-ring sealed.
- 4 Modes: High: 36,000 Candela peak beam intensity, 140 Lumens, 4 hour runtime
Low: 12,000 Candela peak beam intensity, 47 Lumens, 15 hour runtime
Flash: 8 hour runtime
Moonlight: 20 day runtime



Survivor®LED

90503 Steady Charge AC/DC Orange

90500 Light Only (Nicad) Orange

90510 Light Only (Nicad) Yellow

90520 Light Only (Nicad) Black

90540 Light Only (Alkaline) Orange

90541 Light Only (Alkaline) Yellow

90545 Light Only (Alkaline) Black



Rechargeable Battery Pack



Alkaline Battery Pack



Bank Charger

Streamlight® Survivor® LED Bank Charger

...Simultaneously charge up to 5 Survivor LED flashlights!

This is an efficient method to keeping your Streamlight Survivor LED or Knucklehead flashlights fully charged. Eliminates the need to have up to five separate chargers to perform the same task.

These chargers can be mounted within a truck, boat or any workspace that has a power source.

- Available in your choice of 12V Direct Wire or 120V AC
- Compatible with Survivor LED or Knucklehead rechargeable flashlights
- Approximate Dimensions: 18.5"L x 5"W x 5.5"H

90400 Bank Charger (SC) 120V AC

90401 Bank Charger 12V DC



PolyTac 90™ LED

Streamlight PolyTac 90™ LED... Compact Right-Angle Light!

PolyTac 90™ LED

Versatile right angle compact tactical flashlight C4 LED technology, impervious to shock with a 50,000 hour lifetime.

- 88834 Orange
- 88830 Black
- 88831 Yellow
- 88832 Orange w/ Gear Keeper



Streamlight® STINGER® 2020

The Stinger 2020 is the next evolution in high-performance flashlights and produces 2,000 lumens. Its aluminum alloy body with an anti-roll design is ergonomically shaped for a sure grip. It features dual power switches and an intuitive mode selector switch for ease of use. A long-lasting SL-B26™ USB rechargeable battery pack offers multiple charging options using existing Stinger smart chargers and bank chargers to charge inside the light; use a dual USB cord to charge the battery pack outside the light or a Li-ion battery bank charger to charge multiple batteries at once.

- 4 Modes: High for a high lumen beam: 2,000 lumens; 315m beam; runs 2 hours
Medium for bright light & longer run time: 850 lumens; 200m beam; runs 4 hours
Low for extended run time: 100 lumens; 70m beam; runs 24 hours
Strobe for disorienting or signaling: runs 3.25 hours

- Corrosion resistant, gasket-sealed Borofloat® glass lens
- IPX7 waterproof; 2m impact resistance tested
- 7.67" Long; Weight 12.3 oz

78101 Stinger 2020 - 120V AC/12V DC 1 holder - Black

78104 Stinger 2020 - 12V DC 1 holder - Black



STINGER® 2020



Streamlight® Vulcan® 180 LED Rechargeable Lantern

Lightweight and portable, the Vulcan 180 is designed to burn brighter and run longer making it an essential fire-fighting tool. This rechargeable, waterproof lantern has a 180 degree tilting head which allows you to direct the light where you need it. Three LEDs bring you extreme brightness along with two blue taillight LEDs for visibility in thick smoke.



Vulcan® 180 LED

Vulcan® 180 LED Standard System

Includes quick release buckle strap, charging rack and AC/ DC chargers
44311 Orange

Vulcan® 180 LED Vehicle Mount System

Includes quick release buckle strap and 12V DC vehicle-mountable direct wire charging rack
44315 Orange



Streamlight® Fire Vulcan® LED Rechargeable Lantern

C4 LED Technology, 2 ultra-bright blue tail light LED's.



Fire Vulcan® LED

Fire Vulcan® LED Standard System

Includes 120V AC, 12V DC chargers, shoulder strap and charging rack.
44450 Orange

Fire Vulcan® LED Vehicle Mount System

Includes truck mountable 12 volt DC direct wire charging rack and shoulder strap.
44451 Orange

Streamlight® E-Flood® FireBox® Rechargeable Lantern

The E-Flood® models are industrial-duty, rechargeable, portable lanterns featuring power LED technology for high brightness, long runtime and high reliability.

- Six (6) C4® LEDs, impervious to shock with a 50,000 hour lifetime
- 6 wide pattern parabolic reflectors produce a smooth flood pattern
- 2 levels of lighting: High: 4,000 candela (Peak Beam Intensity), 615 lumens, up to 8 hrs.
Low: 2,150 candela (Peak Beam Intensity), 330 lumens, up to 18 hrs.
- Zero-maintenance, 6V, 12 amp-hour sealed lead acid battery is rechargeable up to 500 times
- Rubberized impact bumper, lens ring and cushioned-grip handle
- Length: 11.5" Width: 5.1" Height: 7" Weight: 7.9 lbs.

E-Flood FireBox Standard System

Includes AC and DC charge cords, charge rack, and shoulder carrying strap,
45811 AC/12V DC - Orange

E-Flood FireBox Vehicle Mount System

Includes a vehicle-mountable hard-wire charge rack and shoulder carrying strap
45815 12V DC - Orange



E-Flood Firebox



Streamlight® E-Spot® FireBox® Rechargeable Lantern

An industrial-duty, rechargeable, portable lantern featuring 2 ultra-bright blue taillight LEDs LED technology for high brightness, long runtime and reliability.

- 3 C4® LEDs and deep dish parabolic reflectors to produce a large spot pattern
- LEDs are impervious to shock with a 50,000 hour lifetime
- 2 levels of lighting:
 - High – 55,000 candela peak beam intensity; 540 lumens, 7 hours
 - Low – 32,000 candela peak beam intensity; 330 lumens, 15 hours
- Jumper selectable high or low setting to allow selection of more light output or more runtime
- Zero-maintenance 6V, 12Ah sealed lead acid battery. Rechargeable up to 500 times
- IPX4 rated for water-resistance

E-Spot FireBox Standard System

Includes both AC and DC charger cords, a charge rack and shoulder carrying strap
45861 AC/12V DC - Orange

E-Spot FireBox Vehicle Mount System

Includes a vehicle-mountable hard-wire charge rack and shoulder carrying strap
45865 12V DC - Orange



E-Spot Firebox



Akron SceneStar™ LED Scene Light

ELSS-SLDC - 14,000 Lumens

ELSS-XLDC - 19,000 Lumens

ELSS-XLAC - 20,000 Lumens (120VAC or 240VAC)

The new LED High Power Scene Light has been engineered to provide industry leading levels of light output with consistency and reliability. SceneStar LED scene lights will continue to provide overall illumination even at elevated operating temperatures through optimized thermal management. Solid-state electronics ensure a lifetime of peak performance.

- Available in AC and DC versions
- Outstanding light output and overall illumination
- Optimized thermal management reduces LED temperatures for long life and reliability
- Streamlined aesthetics in a compact design
- Low ultraviolet light reduces insects during nighttime operation
- Standard powder coat paint in white
- Heavy-duty 6 year warranty
- Serviceable construction



***Call for pricing**

<i>Light Head</i>	<i>Bulb Type</i>	<i>Wattage</i>	<i>Voltage</i>	<i>Amps</i>	<i>Lumens / Candle Power</i>	<i>Certifications</i>	<i>Light Head Dimensions</i>
ELSS-SLDC	LED	150	10-32 V DC	12 (12 V DC) 6 (24 V DC)	14,000	CE	14" W x 4 1/4" H x 5.6" D (356 x 108 x 142 mm)
ELSS-XLDC	LED	220	10-32 V DC	18 (12 V DC) 9 (24 V DC)	19,000		
ELSS-XLAC	LED	220	120 AC/240 AC	1.8/9	20,000	UL, CE	

Mounting Options:

- Tripod
- Pole
- Portable
- Recessed
- Brow
- Fixed
- Under Aerial

Tripod Base



Push-Up



Pull-Up



Portable Ground Base



Recessed Mount



Brow Mount

Akron Revel Scout™ Tactical Scene Light

This tactical LED scene light is designed to increase the safety of both firefighters and emergency responders. With versatile mounting options – set, hang, strap, spike – and a removable, rechargeable battery, the Revel Scout revolutionizes the operational ease of fire scene lighting.

The Revel Scout combines a spot and flood light pattern of 14,000 lumens in a 12 lb. package, and the LED tactical scene light can be used to evenly light both entire exterior and scenes and interior spaces. Compact, lightweight and portable, the Revel Scout's flexibility will provide you with more options than most LED scene lights to help you accomplish various tasks.

Powered by a 28V removable, rechargeable battery, the Revel Scout is all you need to light both your exterior scene and interior work area. Easy to move or position, the Revel Scout's combination of flood and spot light optics increases your overall scene visibility when lighting exterior areas such as vehicles, structures, parking lots and overhead hazards. Continue work inside for overhaul and other tasks.

- Optional truck mounting bracket, storage case, and battery charger accessories
- Integrated strap included to secure to horizontal object, ladder rung, etc.
- On/off toggle switch to turn light on and off and adjust to 4 light levels
- Corrosion-free construction
- Zero deployment time
- Battery type: 28V LI-ION, Weight: 3 lbs (1.4 kg). Charge time: 1 hour
- Warranty: Light assembly: 6 Year, Battery and charger: 1 Year

• **REVEL SCOUT STANDARD PACKAGE** - comes with one battery and a charger



Multiple placement options – set on a flat surface, hung over a door, strapped to a ladder or hung on any number of vertical surfaces with its integrated spike.

Model Number	Description
ELRE-SCOUT-120	Revel Scout™ Standard Package with 120V charger
1224-RSBC	12/24V Charger
50AH-RSB	Additional Battery
SCOUT-MT	Truck Mounting Bracket
SCOUT-CASE	Storage Case for Scout and Battery

Revel Scout also available with DC Charger

***Other accessories available - call for pricing**

Akron Revel™ LED Scene Light Head (28000 Lumen / DC)

Turn any dark, hazardous situation into daylight with the Revel, Akron's high powered LED scene light. Bursting with 28,000 lumens, the Revel is all you need to light your entire scene. The patent-pending combination of spot and flood performance increases your overall scene visibility when lighting your exterior spaces such as vehicles, structures, parking lots and overhead hazards. Available as a true surface mount, the Revel can be easily installed in any location on your truck. Other vehicle mounted configurations include: brow, swivel base, pedestal, push-up, pull-up, air operated, and manual mast. The unique, push button swivel makes adjusting and redirecting your light simple with a gloved hand.

- 32 LEDs dedicated to lighting objects at a distance
- 12 High-powered LEDs to distribute light across the entire scene
- Hard-coated polycarbonate lens
- Screws for easy surface mounting
- Rubber mounting pad to isolate light from vehicle
- Lightweight cast aluminum housing
- Multiple mounting points for various applications
- Unique cooling fins for optimal thermal management
- Low ultraviolet light - attracts less insects during nighttime operation
- Standard color is white
- 6 year warranty
- Available as 14000 Lumen/DC - 16 LED's/6 High-powered LED's

Model Number	Description
ELRE-XLDC	Revel™ LED Scene Light Surface Mount - 28000 Lumen/DC
ELRE-SLDC	Revel™ LED Scene Light Surface Mount - 14000 Lumen/DC

Other configurations available - pole/pedestal/swivel mount - call for pricing



ELRE-XLDC



ELRE-SLDC



Streamlight® Super Bright LED Portable Scene Light II



Portable Scene Light II



Turn to a higher power with the Portable Scene Light II. This waterproof area light requires zero deployment time and features a 360° rotating head so you can aim the light where you need it. Need more light for a job? Stack multiple lights for a “light tower” configuration. Cordless and compact, this scene light eliminates tripping hazards common with corded lighting options. Plus, portability from job to job is a snap

- Produces a high lumen flood pattern
- Five intensity levels correspond to desired run time
 - 100%: 10,000 lumens; runs 2 hours
 - 80%: 8,300 lumens; runs 2.75 hours
 - 60%: 6,300 lumens; runs 3.75 hours
 - 40%: 4,500 lumens; runs 5.75 hours
 - 20%: 2,300 lumens; runs 11 hours
- Digital display shows intensity level and run time
- Hooked feet for hanging over doors, guard rails, fences, etc.
- Easy to use toggle switch – choose from 5 intensity levels
- Multi-level illumination for scene lighting; head swivels 360° to aim the beam where you need it
- Lithium ion batteries charge in 6 hours
- Batteries will continue charge while operating directly from an AC or DC power source so you can be confident that you will always have a light when you need it
- Indefinite run time on AC or DC external power with the supplied power cords
- IPX7 rated; waterproof to 1m for 30 minutes
- High-impact, thermoplastic housing mounted in a virtually indestructible alloy steel frame
- Includes AC/DC charge cords
- Compact size (16x11x12 in; 40.6x28.9x30.5 cm)
- Lightweight: 15.38 lbs. (6.1 kg)
- Limited lifetime warranty



46000 Portable Scene Light II - 120V AC/12V DC - Red

Streamlight® Portable Scene Light & Ext

We've made the Portable Scene Light even brighter – it now produces 5,300 lumens!

Rapidly deployed and easily stowed, the Scene Light features a narrow footprint and 72" extension pole, letting you bring this light almost anywhere - from wide open places to tight, confined spaces. The Scene Light is an industrial-duty, rechargeable, completely portable high lumen flood light. It uses six (6) LEDs and wide pattern reflectors to produce a uniform flood pattern with two (2) selectable beam widths and three (3) light output intensities. The Scene Light's telescoping pole and rotating head extend to an overall height of 72 in. It also features stabilizing legs that fully deploy, and lock, in less than 30 seconds.

- Six C4® LED and wide reflectors produce a uniform flood pattern
- Three user-selectable outputs:
 - High for a super-bright flood beam: 5,300 lumens; 410m beam; runs 4 hours
 - Medium for an intense beam and longer run time: 2,500 lumens; 292m beam; runs 9 hours
 - Low for when a less intense beam is ideal and for longer run time: 1,300 lumens; 215m beam; runs 18 hours
- Optimum peripheral illumination for scene lighting; 90° swivel neck allows you to aim the beam where you need
- Sealed lead acid batteries, rechargeable up to 500 times
- Batteries will continue charge while operating directly from an AC or DC power source so you can be confident that you will always have a light when you need it
- Indefinite run time on AC or DC external power with the supplied power cords
- Integral D-rings allow attachment of the included shoulder strap
- Design allows for the light to be used in confined spaces and rugged terrain
- Cord built into the pole to avoid snags
- Stabilization legs provide balance on uneven surfaces
- Lead acid batteries provide ballast and stability
- 25 lbs (11.3 kg) provides weight stabilization, but is light enough to carry
- Packs to a compact size (22"; 55.88cm) for easy stowage
- High-impact thermoplastic housing; weatherproof construction
- IP67 rated; dust-tight and waterproof to 1 meter for 30 minutes.
- Designed to resist 40mph wind continuous in all directions with head fully extended
- Available in Safety Yellow with AC and DC charge cords and shoulder strap
- Assembled in USA
- Limited lifetime warranty



Portable Scene Light



45670 Portable Scene Light with 120V AC/12V DC (72" pole) - Yellow

45680 Portable Scene Light EXT with 120V AC/12V DC (84" pole) - Yellow

SPILFYTER® No Decision Response Universal Sorbents for Hazardous Materials

Dikes - Socks

Dikes-Socks are ideal for containing and absorbing hazardous liquids. Their moldable shape easily conforms to fit around equipment, drums, tanks and walkways.

Part#	Qty/Case	Size
S2-30	15	3" x 4'
S2-37	6	3" x 10'



Pillows

Universal Sorbent Pillows are the easy to handle solution for the cleanup of hazardous liquids. Pillows are highly absorbent, picking up many times their weight in hazardous liquids. They are especially good for working in confined spaces such as sumps, catch basins and settling ponds.

Part#	Qty/Case	Size
S2-66	10	8 1/2" x 17"



Pads - Sheets

Universal Sorbent Pads - Sheets will absorb hazardous drips, splashes, leaks and spills.

Part#	Qty/Case	Size
S2-71	100	12" x 12"
S2-75*	100	16" x 18"

*Double Weight



GRAB&GO® Quick Response Bucket

Specially designed for portability the GRAB&GO® Bucket is packed with sorbent dikes and pads for quick containment of hazardous spills. Just grab a bucket & go.

Part#	Included with bucket
205304	(4) 3" x 4' Dikes
	(5) 12" x 12" Pads



SENSIT® P100 - PERSONAL GAS MONITOR

The SENSIT® P100 has high and low alarm levels through audio, visual and vibratory warnings. TWA and STEL alarms are also included, as well as alarm-event data logging. Durable rubber-coated housing withstands incredible abuse and is nearly waterproof.

Key Benefits

- Easy to Use - One button operation
- Serviceable Sensors
- Manufactured and Serviced in Indiana
- Operates 2 Years Before Service is Required
- Easy Calibration
- Limited 2 Year Warranty (including sensors)

Gas	Item #
CO	912-00000-03



Sensit® Gold Series

Leak detection and gas monitoring combined in a single package. These instruments can be custom configured to meet your needs when detecting combustible gases in the LEL range, locating combustible gas leaks in the PPM range, measuring oxygen content, carbon monoxide and/or hydrogen sulfide. All instruments are equipped with an internal pump for constant sampling. Audible and visual alarms warn the operator of hazardous conditions.

Key Benefits

- Fast leak detection
- Simple calibration
- Lowest overall cost of operation
- Simultaneously view all gas concentrations
- Download operational and calibration data

Gas	Item #
LEL, CO, O2, H2S	909-FC000-H
LEL, CO, O2, HCN	909-FC000-J



SENSIT® P400 - Personal Gas Monitor

SENSIT® P400 is a multi gas detector and hand-held detector designed personal gas monitor to warn the user of hazardous gases in their working environment. The P400 can be configured with 1 to 5 sensors. Optional, Immediate Detection System (IDS) provides early warning to changes in gas concentrations.

- Audible Alarm - 3 Tone
- Vibration Alarm
- Compliance/Status Indicator
- Easy Field Calibration
- Easy-Access Reusable Dust Filter
- Limited 2-Year Warranty (Inc. sensors)
- Visual Alarm - 360° View
- STEL and TWA Alarms>
- Data Logging
- Easy Clean Dust Pre-Filter
- Alkaline and/or NiMH Battery
- Extended Warranty Available

Gas	Item #
LEL, O2, CO, H2S, HCN	923-FC000-53

Calibration Kit	881-00087	(without case)
LEL,CO/H2S,O2,HCN		



PLEASE CALL FOR PRICING

SENSIT®HXG-2D - COMBUSTIBLE GAS LEAK DETECTION

The First Affordable Multi Gas Detector With True Digital Display!

The SENSIT® HXG-2d gas detector pinpoints leaks quickly with its true digital display and electronic tick control. This multi-gas detector is ideal for natural, butane and propane gas leaks. The SENSIT® HXG-2d is safe, durable and reliable.

Key Benefits

- Direct PPM readout
- Direct "LEL" percent readout
- Electronic tick rate control to pinpoint leaks

Item#
906-FC000-08



**Many other configurations available - please call or check our website for details*

AIRSPACE MONITORING SYSTEMS

Finally, Carbon Monoxide and Gas Detectors you can afford to own!

AI-1100 - Carbon Monoxide Monitor with LED & Audible Alarms

The AI-1100 monitor was designed with EMS use in mind. It is built on the very stable AGS™ solid state platform that doesn't require routine bump testing or calibration and notifies you if something is wrong. Its low overall cost of ownership, very low cost to maintain, five year warranty, and rugged durability makes this monitor the best option for passive screening use. NEVER MISS CO POISONING AGAIN and be protected from inadvertent exposures. FINALLY, AFFORDABLE AND EFFECTIVE PROTECTION, for you and your patients!

- Visual and Audible alarms at 30, 60 and 120ppm CO.
- Best suited for EMS run bags or any environment where notification is needed but an exact concentration reading is not required
- No bump testing or calibration required
- Motion switch mode for extended battery life
- 5 year warranty - Including the sensor. *Upcharge for 10 year warranty
- Not a throwaway! Can be refurbished at the end of warranty or continue to be used with a more frequent verification testing schedule.



AI-1200 - Carbon Monoxide Monitor with Snif, LCD Readout, LED & Audible Alarms

The AI-1200 CO monitor will accurately measure and display CO levels from 12 ppm to 250 ppm. AGS and Snif™ technology provides an update every 4 seconds when in alarm to help you find the source, see the trend and otherwise manage the CO event. There is no routine bump testing or calibration required and the monitor is warranted for five years, including the sensor and its calibration.

- LCD with concentration readout - Visual and Audible alarms at 30, 60 and 120ppm CO
- No bump testing or calibration required
- Motion switch mode for extended battery life
- 5 year warranty - Including the sensor. *Upcharge for 10 year warranty
- Not a throwaway! Can be refurbished at the end of warranty or continue to be used with a more frequent verification testing schedule



AI-1201 - Carbon Monoxide & Methane Monitor w/ Snif, LCD Readout, LED & Audible Alarms

Built on the same technology and with all the features of the 1200 monitor and now incorporates the energy efficiency, motion switch technology, enhanced alarm and backlit LCD screen built into all of our V2 models. In addition to all that, it adds LEL (flammable gas) capability that is calibrated to methane. You can count on the Airspace monitor to give you an accurate reading for methane gases you might otherwise not know are there. Like other LEL sensors, it will also "see" most of the other hydrocarbon gases – such as gasoline, propane, natural gas, hydrogen, acetylene, etc. It won't give an accurate ppm reading for those other gases because the calibration is to methane, but it will be very useful since any ppm reading for those other gases will be an indication of an ambient air saturation – therefore a flame or explosive hazard – is occurring.

- LCD with concentration readout - Visual and Audible alarms at 30, 60 and 120ppm CO and 5000ppm LEL (calibrated to methane)
- No bump testing or calibration required
- Motion switch mode for extended battery life
- 5 year warranty - Including the sensor. *Upcharge for 10 year warranty
- Not a throwaway! Can be refurbished at the end of warranty or continue to be used with a more frequent verification testing schedule





190654 Smith Indian Smokechaser Pro

•Dual Action Fire Pump delivers a continuous flow of water, expelling water on the push and pull of each stroke.

Features:

- 5 Gallon ballistic nylon bag with heavy-duty, load sensitive internal liner
- Ergonomically designed "wedge" shape with heavily padded closed-cell straps to reduce fatigue and resist moisture retention
- Quick disconnect coupled with USFS approved FP300 Fedco Brass Pump
- Dual top handles allow for natural balance and secure field filling
- Military grade laser cut MOLLE system gives the ability to secure common tools and equipment



M100 Ranger Deluxe Rigid-Pak Brush Pump w/ Pistol Grip

- "Thick walled" polyethylene plastic tank will handle rough and harsh environments
- "Non-slosh" rounded design keeps the unit balanced and steady
- Full padded pillow comforts that impinging feel of other tanks
- Completely corrosion resistant; will not rust like galvanized steel models
- Adjustable padded shoulder straps are rugged, yet fit comfortably & distribute the weight evenly
- 5 gallon capacity



DBD500 Smith Indian Chief Dual Bag Tank

- A premium backpack fire pump with an inner bag liner with protective nylon fabric outer bag offers more protection and comfort. It can be easily collapsed and stowed when empty. All the seams are reinforced at all stress points. The brass hand pump is complete with combination nozzle and designed with positive shut-off.
- 5 gallon collapsible bag rolls up to fit in small storage space.
 - Inner bag liner with protective nylon fabric outer bag offers more protection and comfort. Comes with an extra liner stored in utility pouch.
 - Premium padded shoulder straps include clip-on strap to secure pump and leave hands free. Also has center cinch strap to help balance load.
 - Quick disconnect for hose snaps into 3" fill cap.
 - Fedco pump made from 2 seamless brass cylinders, with guide bushing on inner cylinder to ensure bind free operation, approved for use by the US Forest Service.
 - Combination nozzle allows for operator to change from a straight stream to a cone spray quickly and easily without any special tools.
 - MADE in the USA



FSV500 Smith Indian Smokechaser, Vinyl Tank

- An economical backpack fire pump made of strong polyester fabric encased in vinyl for durability. It can be easily collapsed and stowed when empty. All the seams are reinforced at all stress points. The brass hand pump is complete with combination nozzle and designed with positive shut-off.
- 5 gallon vinyl collapsible bag rolls up to fit in a small storage space.
 - Heavy duty vinyl encased poly bag is both durable and comfortable.
 - Large fill cap with watertight gasket and tether that secures to bag.
 - Large 4" filler opening for easy filling.
 - Premium padded shoulder straps include clip-on strap to secure pump and leave hands free. Also has center cinch strap to help balance load.
 - Fedco pump made from 2 seamless brass cylinders, w/ guide bushing on inner, ensure bind free operation, approved for use by the US Forest Service.
 - Combination nozzle allows operator to change from straight stream to cone spray quickly & easily
 - MADE in the USA



FSV500PG Smith Indian Smokechaser, Vinyl Tank w/ Fedco Pistol Grip Pump Same as FSV500

•Built with a PISTOL GRIP HANDLE for easier pumping and improved ergonomics. Solid brass base, with a comfortable rubber grip.

(*MAP pricing is shown - call for discounted price)





MCLF



FF



BRF-5



PUL-5



1304



SHV-S27

MCLF McCloud Tool

Complete with fiberglass handle and heavy duty hoe blade to withstand the rigors of Wildland firefighting. Can be used for trenching, grubbing or slashing brush. Also useful in cutting through deep duff, underbrush, and similar fuels.

FF Flamefighter Fire Flapper

BRF-5 Brush Rake 5' Fiberglass Handle

PUL-5 Pulaski Axe

A combo axe and grub hole ideal for chopping, digging fire lines in hard and soft soils. Ground and tempered cutting edges.

1304 Perfex Fire Broom

A broom especially adapted for fighting fires. Constructed of Rattan with a metal case and a heavy ash handle.

SHV-S27 Scoop Shovel

Super light and super strong aluminum scoop shovel. 27 inch in length with ramon filled fiberglass handle with non-slip D-handle.

Made in the USA



RBL20 True North L2 RIT Bag - Red

NEW AND IMPROVED Made with our exclusive Iron-Cloth™ and L2 sets a new standard for rescue bags. Our ultra tough Iron-Cloth™ combined with the Heat-Shield™ Nylon 6.6 skid plate makes the L-2 the toughest bag on the market, top-to-bottom. The skid plate allows the bag to glide over the roughest surfaces and makes it extremely wear resistant during training evolutions. Innovative access-hatch design makes access to spare face piece and valve set quick and easy. It also features a 60" shoulder strap, which can be re-positioned for carrying, dragging, or lowering the air bottle. Pull the side zipper and the bag expands to allow the addition of a rope bag or secure the bag to the webbing on the outside.

- Designed to hold all makes of masks and bottles
- Quick-Draw transfill hose pocket pulls hose end out and ready to grab
- Flashlight holder on top makes bag easier to find in low visibility conditions
- Two tool pockets provide fast access to small hand tools, light sticks

New Features:

- More 3M Reflective Tape for a 360 degree view
- Additional webbing to attach L2 rope bag to the outside of the L2 RIT bag
- Increased number of rivets to skid plate for maximum durability
- Included strap on the inside to better secure the cylinder in the bag

RBL20



Weight: 5 lbs
Dimensions: 36" x 13" x 10"



RIT-150 Avon Combo Rope n Tool Bag

Developed to be used by FAST/RIT teams. The side pouch provides an area to store rope for easy deployment. The interior of the bag provides space for smaller tag line bags, lights, or other equipment used for Rapid Intervention and Firefighter Rescue.



RIT-150

RIT1080 Avon RIT Team Staging Area Mat

RIT MAT 5' x 10' Features all blue rip stop vinyl. Sections are all marked with the word "RESCUE." There is a pleated area for spare air cylinders. Plenty of room for all your rescue equipment. This is a great tool for all RIT RIC and FAS teams.



RIT1080

JSA-300 Lightweight Basket Type Stretcher

Nylon web straps at chest, abdomen, thigh, and calf. Adjustable footrests for vertical lifting. Frame is 5/8" steel tubing; cross braces and runners 3/16" x 3/4" flat steel. Basket is 18 gauge, 1" hexagon mesh netting.

DIMENSIONS: 80-1/2" L; 8" H



JSA-300W Same as the JSA-300 without leg dividers or footrests.

JSA-300CS Confined Space Splint Rescue Stretcher

The new 19" width Stretcher has been designed for rescues where space is confined. With steel, all-welded rigid construction, which does not rely on the injured person to attain form or rigidity. Light in weight and ample in size. The basket is 18 gauge, 1" hexagon mesh netting. Nylon web straps for securing at chest, abdomen, thigh and calf. Supplemental accessories to facilitate special handling needs are available.

DIMENSIONS:
81 1/2" L; 18 3/8" W; 7 3/4" H



JSA-300-B Break Away Stretcher

Designed to rescue injured persons from locations where lengthy foot travel is mandatory. The stretcher breaks into two halves which can be back-packed to the point of rescue and assembled in seconds. It can be secured to a standard back-pack for carrying. Three positive lock clamps secure two halves together. Four 60" web straps are standard. Stores in space 44" x 12" x 24".

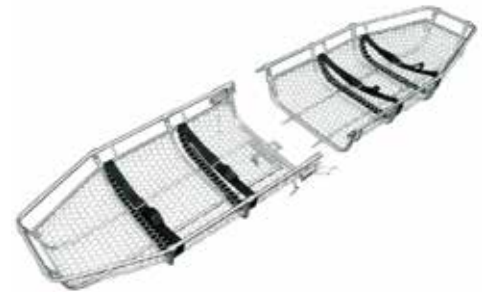

JSA-200 Plastic Stretcher

Yellow high-density polyethylene shell, supported by a stainless steel outer rail, permanently attached with stainless steel semi-tubular rivets. Features molded runners, fully exposed outer rail, non-absorbent foam pad secured to stretcher and four patient restraint straps. Ideal for unusually rugged rescue situations such as industrial, mining or construction. Patent Pending.



JSA-200B Break-Away Plastic Stretcher

The same construction as JSA-200. Designed to rescue injured persons from locations where lengthy foot travel is required. The stretcher breaks into two halves which can be back-packed to the point of rescue and assembled in seconds. Positive-locking quick-release pins secure two halves together. Four straps are standard.

DIMENSIONS: 84 1/2" L; 24" W; 7 1/2" H



Turtle Plastics - DURA CRIB - AUTO X CRIB TOOL KITS

Proudly made in the USA from 100% recycled plastic.

Unlike traditional wood cribbing, Turtle Plastics Dura Cribbing is stronger and more effective. The strong plastic is stable and will not absorb oils or other hazardous fluids on the scene. Each cribbing piece includes a rope handle or molded hand grip for easy carry and deployment. The Dura Crib® Kits includes Cribbing, Wedges, Lock Blocks and Chocks, all packed into one complete kit.



- Non-Absorbing • Super Stability • Corrosion proof • Non-splitting
- Stronger, cleaner, and safer than wood

Available in many kit styles shown below - See our website for more options/info

Part No.	Description	Auto X Tool Kit A	Auto X Tool Kit B	Auto X Tool Kit C	Auto X Tool Kit D	Auto X Tool Kit E
24-18	2" x 4" x 18" Crib	6	12	12	12	24
2/4-12	2" x 4" x 12" Wedge	2	4	4	4	8
44PL-18	4" x 4" x 18" Hybrid Crib	9	18	36	36	36
4/4-20	4" x 4" x 20" Wedge	2	2	8	8	4
67SC-24	6" x 7" x 24" Super Crib			8	8	18
6/7-24	6" x 7" x 24" Super Wedge			2	4	4
3W	3" x 8½" Wedge	1	2	2	4	4
6W	6" x 8½" Wedge	1	2	2	4	4
1B	1" x 9" x 9" Lock Block	1	1		4	4
2B	2" x 9" x 9" Lock Block	1	1		4	4
3B	3" x 9" x 9" Lock Block	1	1		4	4
SC-1	Step Chock	2	2	4	4	4
WC-2	Pair of Wheel Chocks	1	2	4	4	4
CTP1818-1.5	18"x18"x1.5" Mod Pad	1	1	2	2	4
SC-COG-1	Cog Step Chock				2	
CB	Carrying Bags*	1	2	4	4	5
CT	Crib Toters*	1	2	4	4	10
Price	Black Without CB & CT					
Price	Black With CB & CT					



67SC-24



CB



CT

Receive the following additional BONUS items free when purchasing above kits:

When You Purchase an Auto X Tool Kit A you receive (1) Top Bag Pad
 When You Purchase an Auto X Tool Kit B, C, D or E you receive (2) Top Bag

Black Standard - Yellow no longer available

Shipping charges are additional - We will call you for pre-approval

Sava High Pressure Flat Form Lifting Bags

High-pressure lifting bags are used for lifting the heaviest loads. High-pressure lifting bags exert maximum force in a concentrated area, making them ideal when lifting rigid structures in tight places. Their unique structure also allows use in load shifting, heavy truck or aircraft recovery, and different moving situations.



Flat Bag design ADVANTAGES:

- A larger usable area with maximum lifting capacity than conventional bags
- Stability!
- Three (3) bags can be used at the same time, while with conventional you can only use 2 at a time.
- Side profile – during manipulation, protect the inner part of the lifting bag.
- Competition doesn't have FLAT bag design
- Patented diagonal design of reinforced material (minimal safety factor 4x).
- EN 13731 certified (NFPA coming up expected in 2019-2020)
- Certificated also ISO 9001/2000
- The connection is compatible with Hurst & Holmatro products.
- Savatech bags only 1-inch thickness with cone-shaped protection edges. Meaning: Insertion height is <1 inch.
- Resist temperature ranging from -20 to 80 deg. C
- Reflective markings on edges.
- Unique antislip surface: Molded positive gripping interlocking convex rubber dimples w/diameter not less than 3/8".
- "In house" rubber compound (NR-BR type of rubber used for high-pressure lifting bags).
- Great grip. Excellent wear resistance.



Sava High Pressure Flat Form Lifting Bag Kit 10 Bar-145 PSI
Model: **SAVA SFB-H 12/17 (3-BAG-KIT)** call for pricing

Kit Contents:

- (3) 291295 SFB-H 12/17 24" x 24" lifting bags
- 291261 Inflation hose 6' (Red)
- 291262 Inflation hose 6' (Blue)
- 291263 Inflation hose 6' (Grey)
- 291298 Metal box triple deadman unit 145 psi
- 72128-CGA-10 bar Tescom single-stage piston regulator, 145 psi output*
- Air cylinder to be supplied by the customer
- *Includes 6' supply hose (not shown in the above photo)



**Call for more info and pricing*

Sava High Pressure Flat Form Lifting Bag Kit 8 Bar-116 PSI
Model: **SAVA SFB-K 10/17 (3-BAG-KIT)** call for pricing

Kit Contents:

- (3) 519884 SFB-K 10/17 24" x 24" lifting bags
- 516191 Inflation hose 6' (Red)
- 516192 Inflation hose 6' (Blue)
- 529314 Inflation hose 6' (Grey)
- 544124 Metal box triple deadman unit 116 psi
- 72128-CGA-8 bar Tescom single-stage piston regulator, 116 psi output*
- Air cylinder to be supplied by the customer
- *Includes 6' supply hose (not shown in the above photo)

Haz Mat Adapter

Part #	Size
40H25FGGU	2.5" F x (2) GHT Male
40H15FGGU	1.5" F x (2) GHT Male



Line Gauge 0-300 lbs

Part #	Size
LG35	3.5"
LG25	2.5"
LG15	1.5"

*LG15 gauge does not come protected as shown in picture



Cap Gauge 0-300 lbs

Part #	Size
A+154-15	1.5"
A+154-25	2.5"



Inline Jet Siphon (Thread)

Part #	Size
JS160	6.0"
JS150	5.0"
JS140	4.0"



Power Jet Siphon (Thread)

Part #	Size
A1135-60	6.0"
A1135-50	5.0"
A1135-45	4.5"
A1135-40	4.0"



*Due to the volatility in the market, our pricing is, unfortunately, subject to change without notice. Please check our website or call us for the most up to date pricing.

Please call for special threads

ALCO-LITE Sam Carbis Solutions Group, LLC - Aluminum Pumper Type Ladders

ALCO-LITE invented the aluminum ladder. The ALCO-LITE name is synonymous with quality, dependability and service. For these reasons, ALCO-LITE fire ladders are used by all types of departments - paid and volunteer - large and small throughout the U.S. and the world.

All ALCO-LITE ladders meet or exceed the applicable standards established by NFPA for fire department ground ladders. These ladders are designed to be used in accordance with the practices established by both the National Fire Protection Association (NFPA) and the International Fire Safety Training Association (IFSTA). For complete information on these practices, please contact the appropriate organization to obtain their documents relative to fire department ground ladders.

PRL Series - Pumper Type Roof Ladders

Length	New Model Number	Old Model Number
8'	PRL-08	ALP-100-08'
10'	PRL-10	ALP-100-10'
12'	PRL-12	ALP-100-12'
14'	PRL-14	ALP-100-14'
16'	PRL-16	ALP-100-16'
18'	PRL-18	ALP-100-18'
20'	PRL-20	ALP-100-20'



PRL Series

Roof Ladders have high strength steel, 3/4" rotating roof hooks with reinforcing brace for longer service and durability

PEL Series - Pumper Type Two-Section

Length	New Model Number	Old Model Number
12'	PEL-12	ALP-200-12'
14'	PEL-14	ALP-200-14'
16'	PEL-16	ALP-200-16'
20'	PEL-20	ALP-200-20'
24'	PEL-24	ALP-200-24'
28'	PEL-28	ALP-200-28'
30'	PEL-30	ALP-200-30'
35'	PEL-35	ALP-200-35'

PEL3 Series - Pumper Type Three-Section

Length	New Model Number	Old Model Number
24'	PEL3-24	ALP-300-24'
28'	PEL3-28	ALP-300-28'
30'	PEL3-30	ALP-300-30'
35'	PEL3-35	ALP-300-35'
40'	PEL3-40	ALP-300-40'NS
40'	PEL3-40P*	ALP-300-40'

*P includes staypoles

FL Series - Folding Ladder

Length	New Model Number	Old Model Number
8'	FL-08	ALP-080-08'
10'	FL-10	ALP-080-10'
12'	FL-12	ALP-080-12'
14'	FL-14	ALP-080-14'



PEL Series PEL3 Series FL Series

Ladder Covers

- Heavy Duty Yellow Cordura Nylon
- Reflective strip with "STAY BACK" sewn on
- High density foam padding for bump protection

Sizes shown below are inside dimensions

651	22"H x 4" W x 8" D
652	24"H x 9" W x 8" D
653	26"H x 11" W x 8" D

*At the time of printing, all prices on this page were current. However, due to volatility of metal prices, all prices on this page are subject to change as dictated by market prices. Please call to verify prices before placing your order.

Action Coupling & Equipment, Inc
Airspace Monitoring Systems
Akron Brass Company
Alert Visions
Amerex Corporation
Armor Express
Avon Manufacturing Company
Black Diamond Protective Equipment
CET Fire Pumps Manufacturing
CrewBoss
Croker
DB Smith & Co.
Duo-Safety Ladders
Elkhart Brass Manufacturing Co.
Fieldtex Products
Fire Hooks Unlimited
Fire Research Corp.
FireCraft® Safety Products
Flamefighter Corp.
Fol-Da-Tank Company
Game Sportswear, Ltd.
Gemtor, Inc.
Gerber Outerwear
Golfire, Inc
Grime Boss (Nice-Pak)
Groves Ready Rack
Haix North America, Inc
Harrington, Inc.
Junkin Safety Appliance Company
Key Fire Hose

Kochek Co. Inc.
Kroll International
LION
LION TotalCare
Majestic Fire Apparel
Mercedes Textiles Limited
MDI Traffic Control Products
Nightstick - Bayco Products
North American Fire Hose
Paratech, Inc
Paul Conway Shields (Conway Shield)
Petra-Roc Hi-Vis Safety Wear
Portwest Workwear & Safety Products
R & B Fabrications, Inc.
Ram Air Gear Dryers
Ringers Gloves
Rock-N-Rescue
Sam Carbis Solutions (Alco-lite Ladders)
Savatech Corp.
Smith & Warren
Spilfyter
Streamlight, Inc.
Super Vac Manufacturing Co.
Team Equipment
Thorogood by LION
True North
VizCon, LLC
Weinbrenner Shoe Company/Thorogood
Zico (Ziamatic Corporation)



The end-all in fire safety®

PAYMENT - Net 30 Days for all Fire Depts. and State or Municipal Agencies. We also accept AX, Discover, MasterCard and Visa.

FREIGHT - Except where stated otherwise, all orders will have freight charges added to the item purchased.

RETURNS - Many items in this catalog are custom orders and not subject to cancellation or return. Orders that may be returned are subject to a 25% restocking charge. Absolutely no merchandise may be returned that is not new and unused.

****Please do not return any merchandise without prior approval and before receiving a return authorization number.***

WARRANTY AND REPAIRS - All merchandise in this catalog is subject to each manufacturer's warranty. Due to OSHA regulations, any garment returned for warranty must first be laundered.

ACKNOWLEDGMENTS - We mail to the billing address a copy of all sales orders. Please review and advise our office of any discrepancies immediately.

PRICING VALIDITY - We will hold all pricing in this catalog until we are advised of price increases by our manufacturers. In the event of a price increase, we will notify you before processing your order. Our toll free number is for your convenience, we suggest you occasionally call us to verify prices before placing orders. Note: Current pricing is typically available on the website.

MINIMUM CHARGE - \$50.00 - We reserve the right to waive the minimum charge. We endeavor to eliminate any typographical errors or omissions but cannot be held responsible if they occur in this catalog.

ORIGIN & FAR COMPLIANCE - SUPPLIER reserves the right to furnish either foreign or domestic material unless otherwise specified by the customer at the time of quotation and noted on the subsequent purchase order. Requirements for product compliance and certification with the Buy American Act, Buy America Act, and any other Federal Acquisition Regulation shall be noted on the purchase order. Failure to document domestic and federal procurement requirements on the purchase order shall result in PURCHASER assuming all liability and replacement costs for products determined to be non-compliant.

FORCE MAJEURE - Morris Group International companies will not be liable for any failure or delay in performing an obligation that is due to any of the following causes: acts of God, accident, riots, war, terrorist act, epidemic, pandemic, quarantine, civil commotion, breakdown of communication facilities, breakdown of web host, breakdown of internet service provider, natural catastrophes, governmental acts or omissions, changes in laws or regulations, national strikes, fire, explosion, transportation issues or generalized lack of availability of raw materials or energy.



The end-all in fire safety®



The end-all in fire safety[®]

**Fire-End & Croker Corp.
7 Westchester Plaza
Elmsford, NY 10523-1678**

CELEBRATING OVER 100 YEARS OF SERVICE, est. 1911
Quality Products • Competitive Pricing



WWW.FIRE-END.COM