

CUSTOMER NAME: _____ PHONE: _____ JOB #: _____ INSTALLER: _____

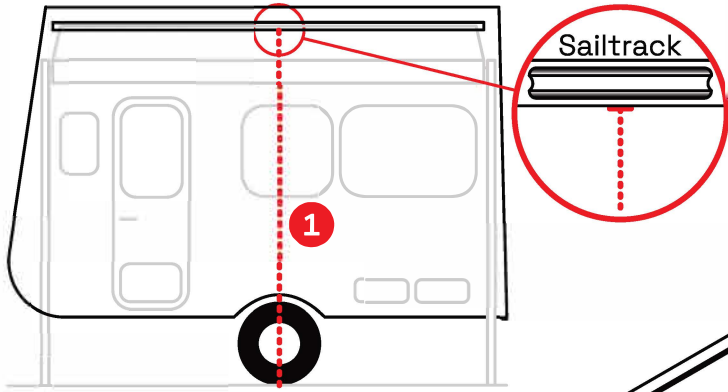

1 Van height. Measure from the ground at the centre of wheel(s) to the bottom of van sail-track.

2 Wall height. The height of the legs when fully extended. Should be approximately 2100mm.

3 Angle. The width of the awning from where the material attaches to the van, to the empty groove in the awning barrel.

4 Vinyl length. The length of the vinyl measured along the barrel.

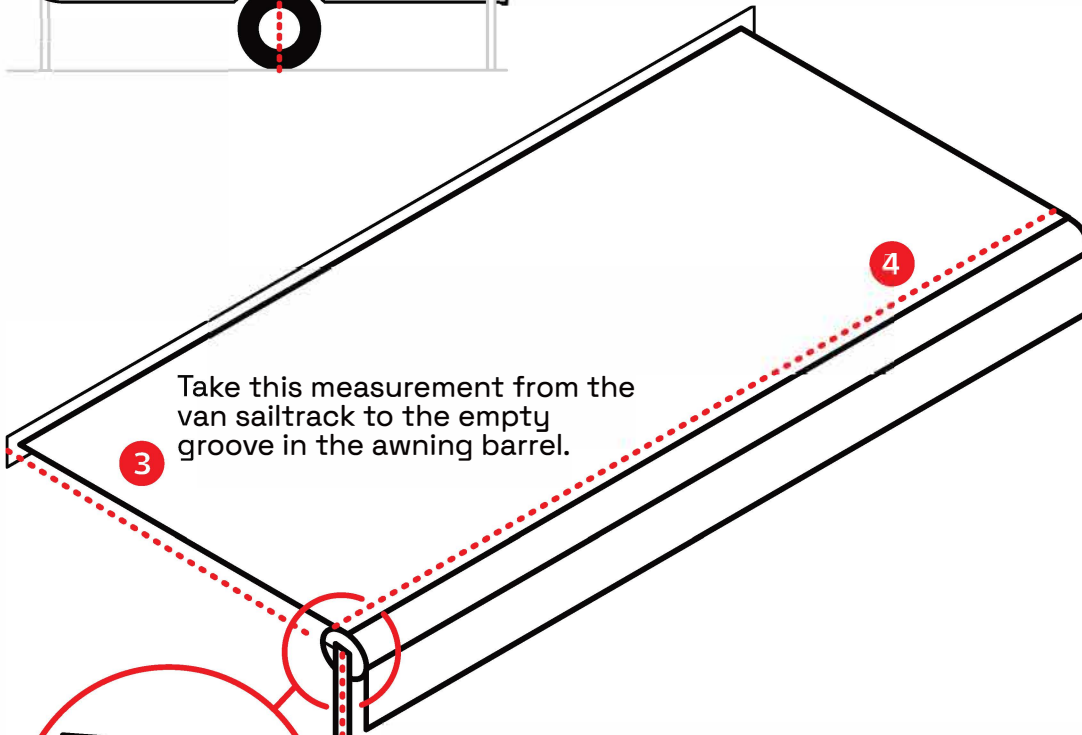

Take this measurement from the van sailtrack to the empty groove in the awning barrel.

5 Pop-top Infill. This measurement only required on pop-top vans.

6 Pop-top roof. Measure the height of the pop-top roof.

2 Ensure the legs are vertical.

POP-TOPS ONLY

Measure from top of van to middle of sail-track when roof is pop-top is up.

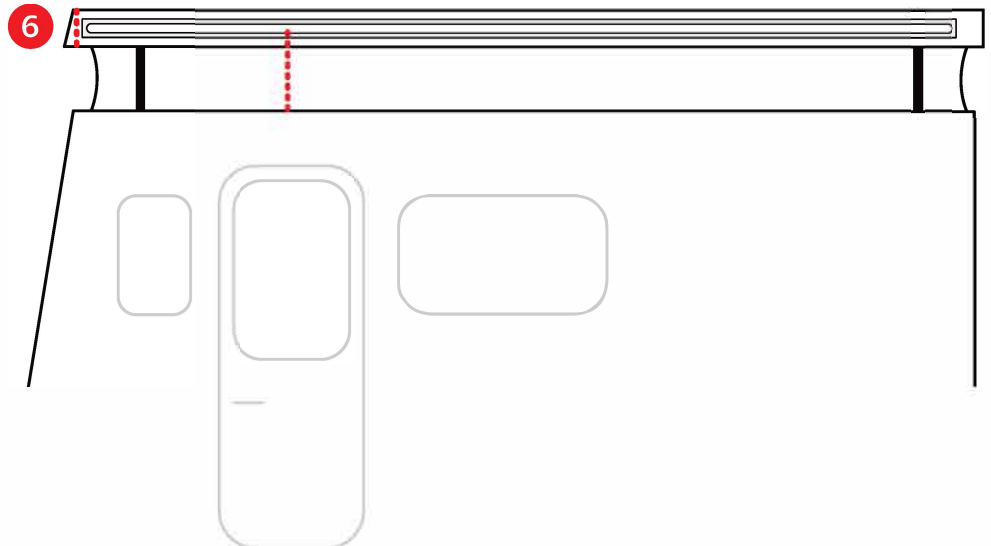

Ensure the groove in the awning barrel is facing 9 o'clock towards the van.

LAYOUT 1
Awning vinyl length up to 4m

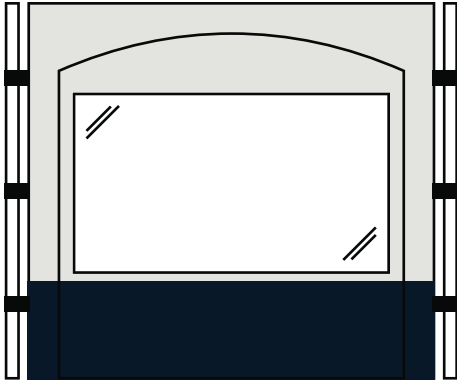

LAYOUT 2
Awning vinyl length 4m to 8m

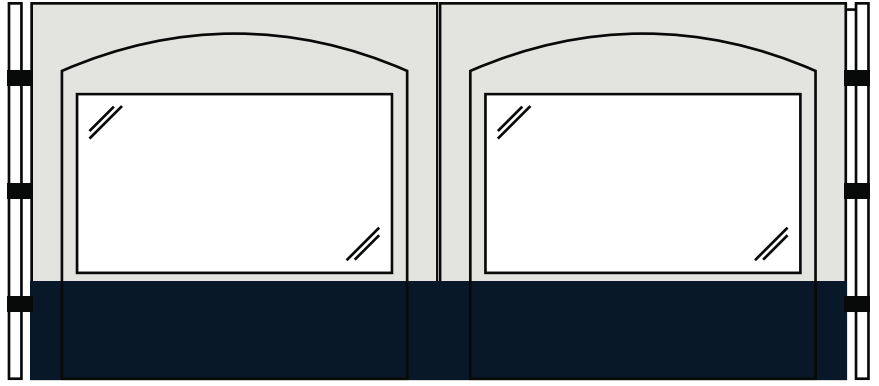

LAYOUT 3
Awning vinyl length over 6m

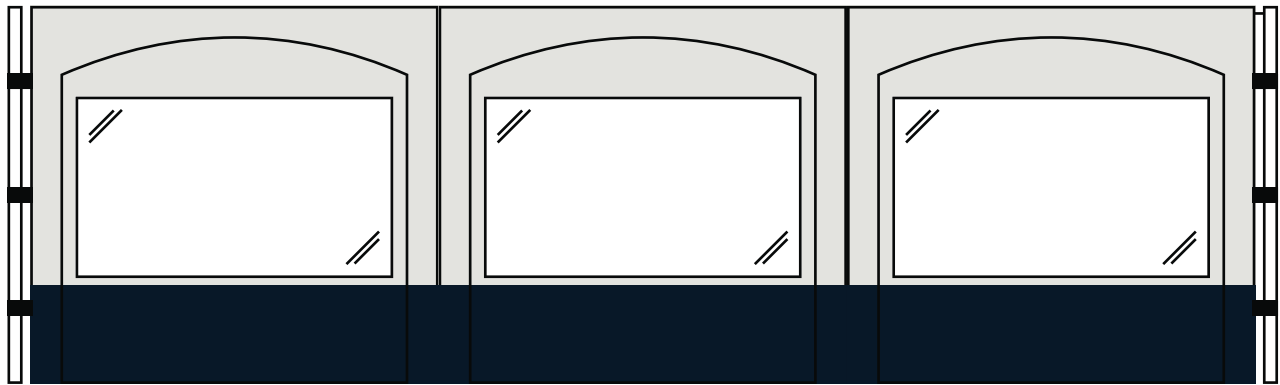

ANNEXE COLOUR OPTIONS

GREY CANVAS UPPER GREY CANVAS UPPER

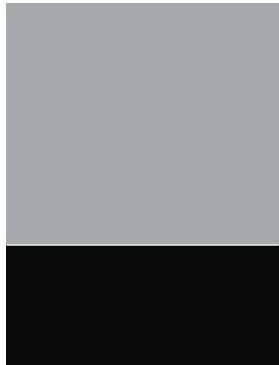

BLACK VINYL BASE

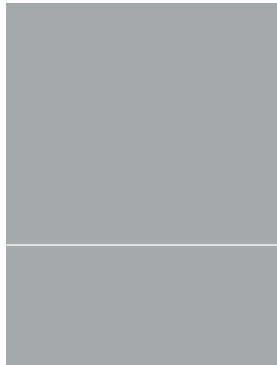

GREY VINYL BASE

COLOURS SHOWN ARE A REPRESENTATION ONLY

AWNING MAKE

<input type="checkbox"/> AUSSIE TRAVELLER	}	MANUAL	<input type="checkbox"/>	
<input type="checkbox"/> DOMETIC		ELECTRIC	<input type="checkbox"/>	
<input type="checkbox"/> CAREFREE		MODEL	<input type="text"/>	
<input type="checkbox"/> THULE			<input type="text"/>	
<input type="checkbox"/> FIAMMA			<input type="text"/>	
<input type="text"/>		OTHER		

OPTIONS

INFLATABLE
EXTENSION ROOM

BBQ PORCH

MINI BBQ PORCH

NUMBER OF
CURVED ROOF RAFTERS
REQUIRED

ANTI FLAP KIT

VINYL TUB FLOOR

MESH TUB FLOOR

OTHER/NOTES

DRAFT SKIRT

Please measure the red lines and record them on this form. All measurements in mm.

Customer name:

Phone number:

Installer name:

Draft Skirt Template: **Yes** **No**

Colour:  

Door Curve: (If applicable)

Expanda
Journey
Starcraft
Outback

Silverline
Base Station
Adventurer

None

Standard template Draft Skirt.

Measure each red line on the appropriate template and input the dimensions on this form.

- A:** At wheel - from ground to above wheel arch.
- B:** From bottom edge of door to line intersecting top of line **A**.
- C:** Width of door.
- D:** From bottom edge of door to desired height.
- E:** From top of line **D** to sailtrack.
- F:** From top of line **B** to sailtrack at back of van.

OPTION 1: Door at front.

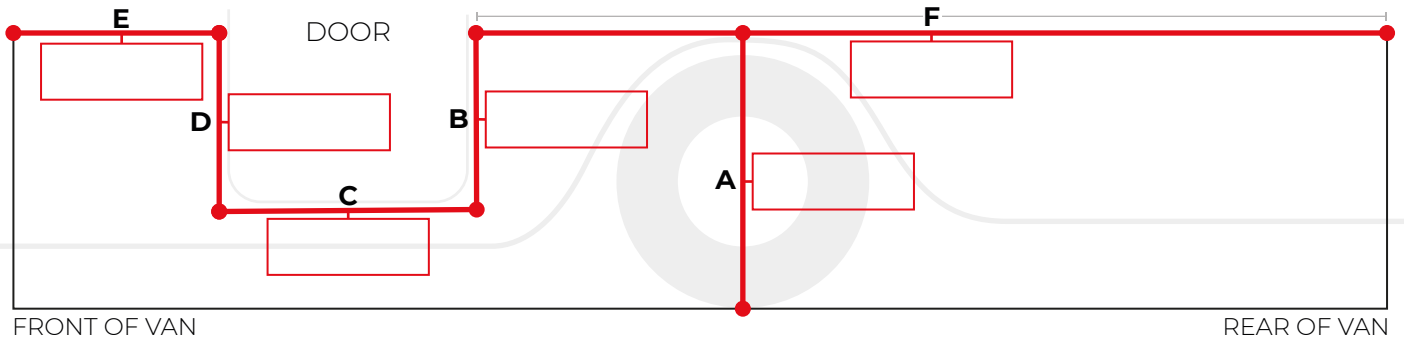

OPTION 2: Door at rear.

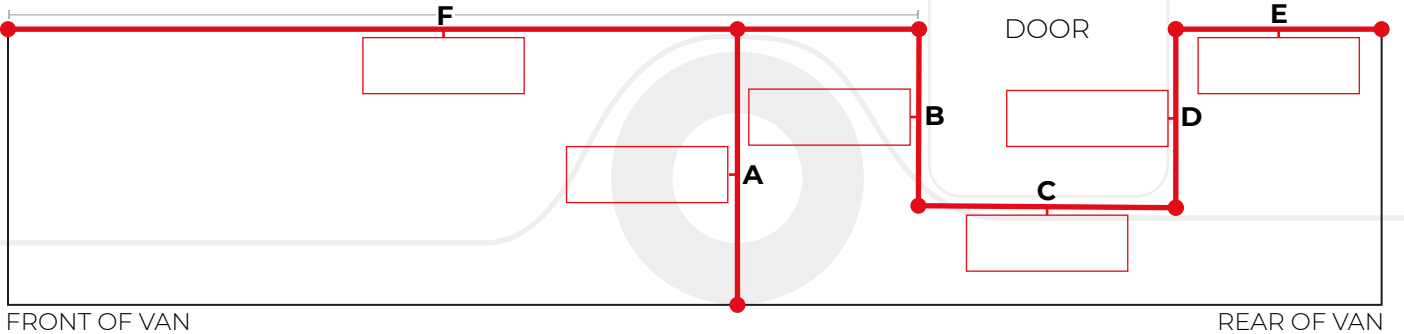

For custom layouts please use grid on the next page.

ENTRY DOOR STEP CUTOUT:

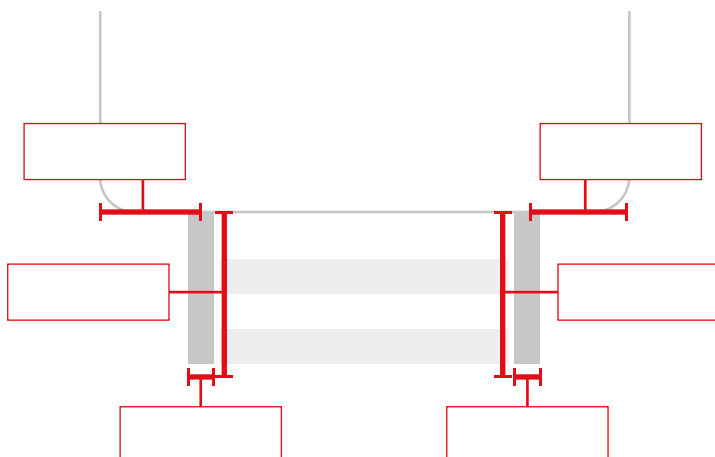

COMMENTS:

DRAFT SKIRT CUSTOM LAYOUT GRID



Use the "Markup" tool on your iPad to draw directly on the grid.

