

CUSTOMER NAME: ..... PHONE: ..... JOB #: ..... INSTALLER: .....

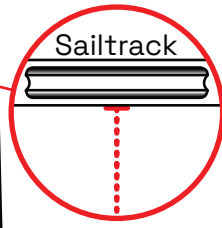
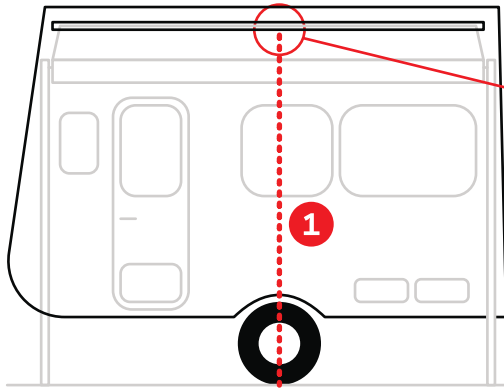

**1 Van height.** Measure from the ground at the centre of wheel(s) to the bottom of van sail-track.

**2 Wall height.** The height of the legs when fully extended. Should be approximately 2100mm.

**3 Angle.** The width of the awning from where the material attaches to the van, to the first spline in the awning barrel.

**4 Vinyl length.** The length of the vinyl measured along the barrel.

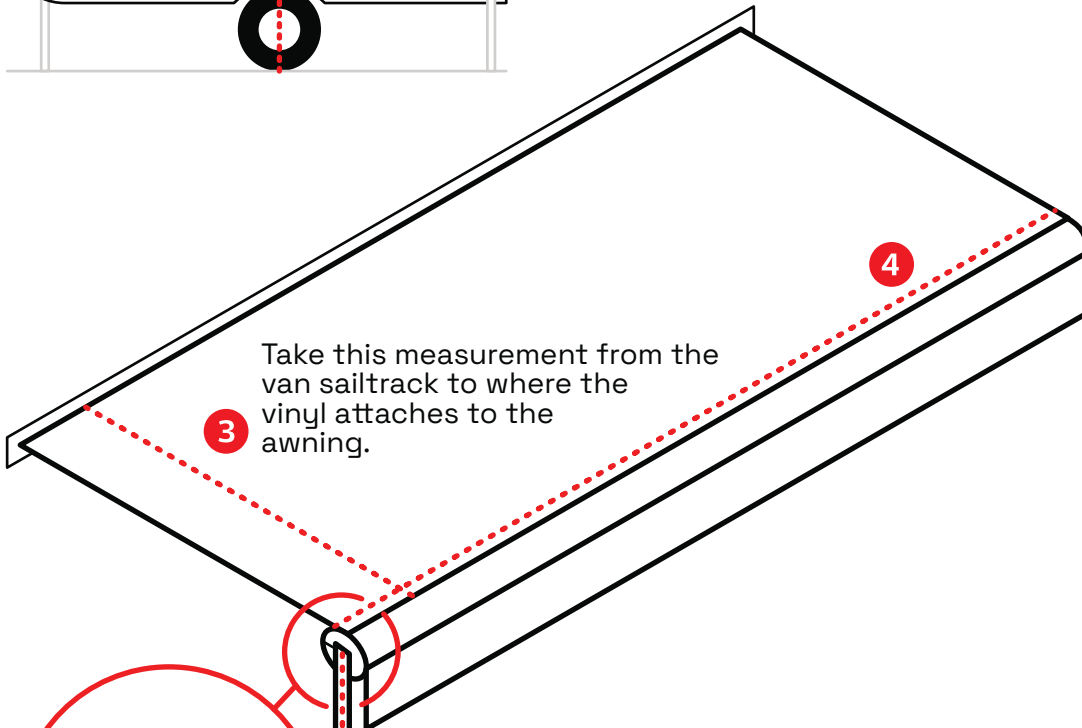

**5 Pop-top Infill.** This measurement only required on pop-top vans.

**6 Pop-top roof.** Measure the height of the pop-top roof.

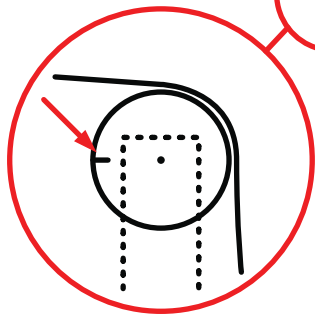

**2** Ensure the legs are vertical.



Ensure the groove in the awning barrel is facing 9 o'clock towards the van.

## POP-TOPS ONLY

Measure from top of van to middle of sail-track when roof is pop-top is up.

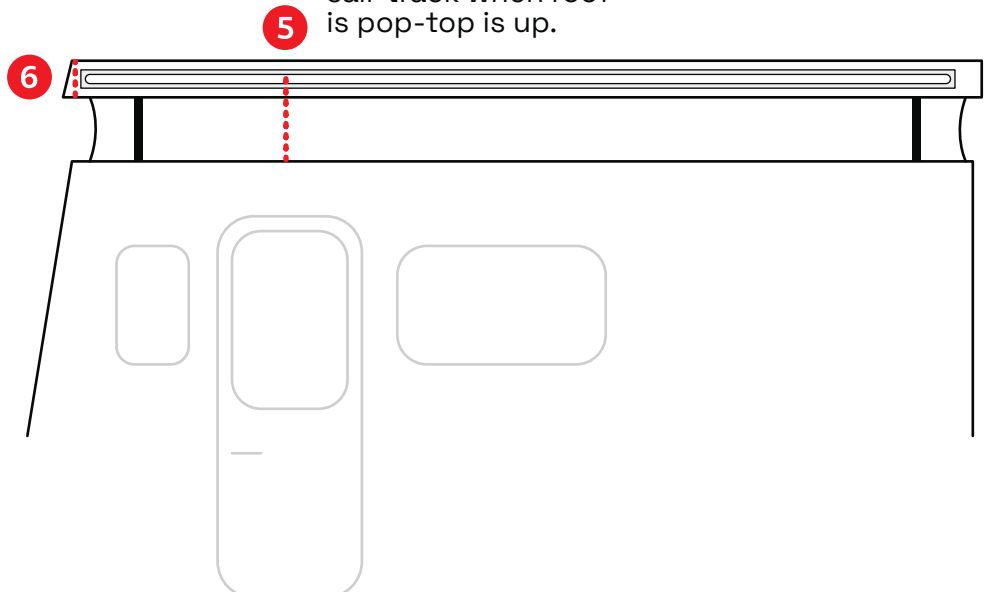

**LAYOUT 1**  
Awning vinyl length up to 4m

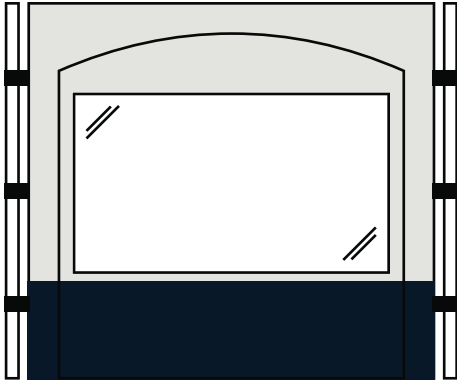

**LAYOUT 2**  
Awning vinyl length 4m to 8m

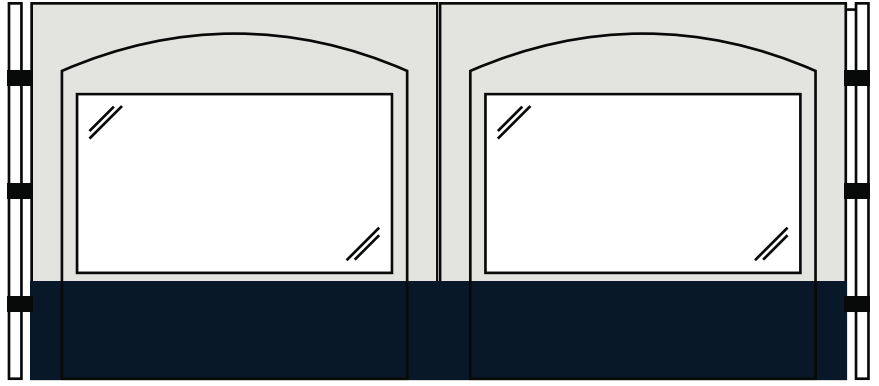

**LAYOUT 3**  
Awning vinyl length over 6m

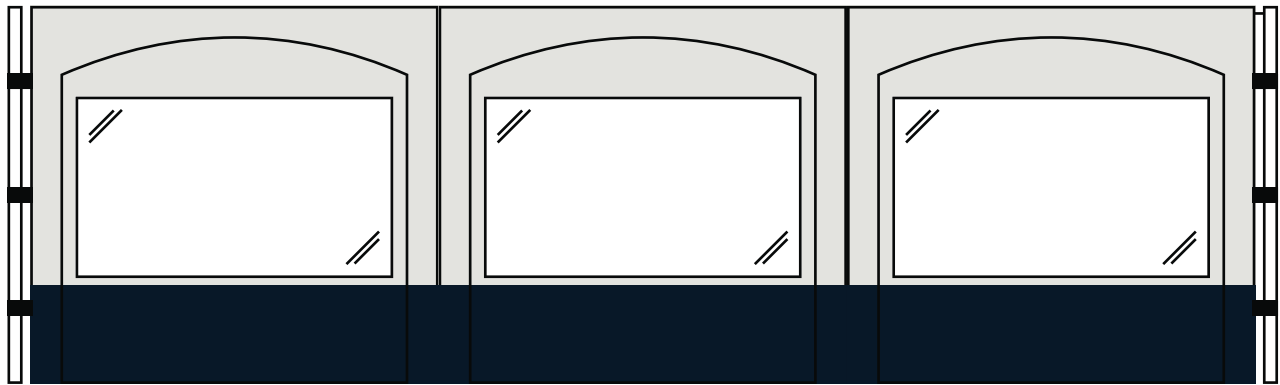

### ANNEXE COLOUR OPTIONS

GREY CANVAS UPPER    GREY CANVAS UPPER

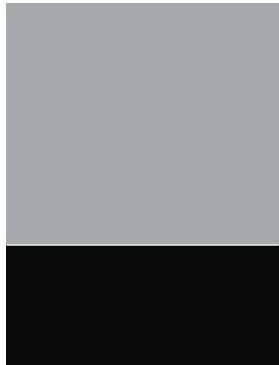

BLACK VINYL BASE

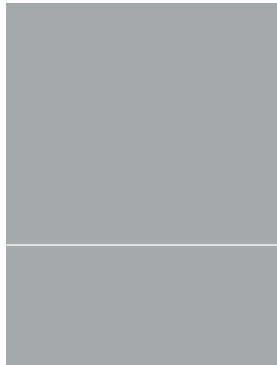

GREY VINYL BASE

COLOURS SHOWN ARE A REPRESENTATION ONLY

### AWNING MAKE

<input type="checkbox"/> AUSSIE TRAVELLER	}	MANUAL	<input type="checkbox"/>	
<input type="checkbox"/> DOMETIC		ELECTRIC	<input type="checkbox"/>	
<input type="checkbox"/> CAREFREE		MODEL	<input type="text"/>	
<input type="checkbox"/> THULE			<input type="text"/>	
<input type="checkbox"/> FIAMMA			<input type="text"/>	
<input type="text"/>		OTHER		

### OPTIONS

INFLATABLE  
EXTENSION ROOM

BBQ PORCH

MINI BBQ PORCH

NUMBER OF  
CURVED ROOF RAFTERS  
REQUIRED

ANTI FLAP KIT

VINYL TUB FLOOR

MESH TUB FLOOR

OTHER/NOTES