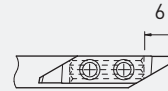

INFO

Nuances et paramètres de coupe
Sorten und Schnittwerte
Grades and machining data

> **1.02****710 / 720**

Pour machines à cames
Für kurvengesteuerte Maschinen
For cam driven machines

> **1.12****730 / 740**

Main series
Small type

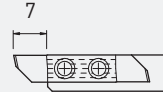
> **1.24****750 / 760**

Main series
Large type

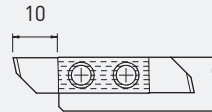
> **1.68****770 / 780****7050 / 7060****W750 / W760****POLYGONAL
INTERFACE****HSK****740Z / 760Z****TORNOS****SCHÜTTE**

Tronçonnage de grande capacité et ébauches larges pour
profilage + porte-outils spéciaux

Abstechen für grössere Durchmesser und breite Rohlinge
für Profilschleifen + Sonderwerkzeughalter

High capacity parting off and wide blanks for profiling +
special tool holders

> **1.132**

Pièces de rechange
Ersatzteile
Spare parts

> **1.166**

TOP-LINE

Codification des plaquettes TOP-Line série 700

WSP-Bezeichnungssystem für TOP-Line 700 Serie

Inserts designation key for TOP-Line 700 series



Dimension
Abmessung
Dimension

Rayon
Radius
Radius

Nuance
Sorte
Grade

Géométrie de coupe / Brise-copeaux / Particularités
 Schneidgeometrie / Spanbrecher / Sondereigenschaften
 Cutting geometry / Chip breaker / Special features

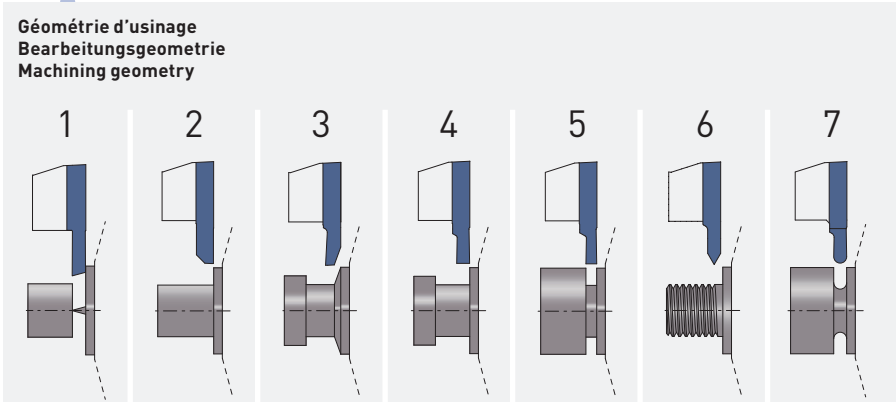

Gamme de produit
 Produktserie
 Product series

définit la compatibilité des plaquettes avec le porte-outil
 bestimmt die WSP und Halter Kompatibilität
 shows the inserts and holder compatibility

L = 1, 3, 5, 7 (chiffre impair / ungerade Zahl / uneven number)

R = 2, 4, 6, 8 (chiffre pair / gerade Zahl / even number)

L 710 | R 720

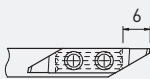

pour machines à cames
 für kurvengesteuerte Maschinen
 for cam driven machines

L 730 | R 740

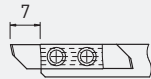

main series
 small type

L 750 | R 760

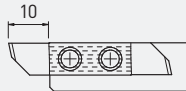

main series
 large type

L 770 | R 780

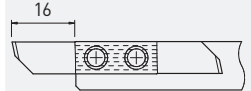

tronçonnage uniquement
 nur für abstechen
 only for parting off

Applitec série 700
 Applitec 700 Serie
 Applitec 700 series

Système de serrage à denture décalée avec 2 vis de fixation
 Spannsystem mit 2 Schrauben und verschobener Verzahnung
 Shifted teeth clamping system with 2 screws

L'outil de référence pour le décolletage

Hochwertiges Wendeplattensystem für Langdrehautomaten

Top class turning tool for automatic lathes

700 Series

100% rigid!

Système de serrage Applitec à denture décalée
 Applitec-Spannsystem mit verschobener Verzahnung
 Applitec clamping system with shifted teeth

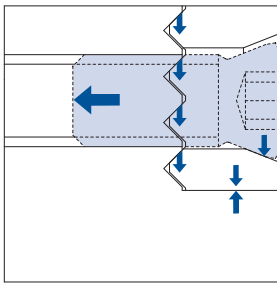
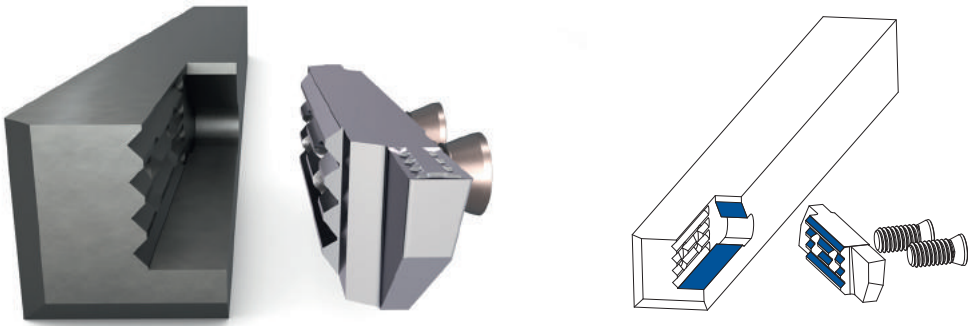

Serrage standard (A)
Standard Spannsystem (A)
Standard clamping system (A)

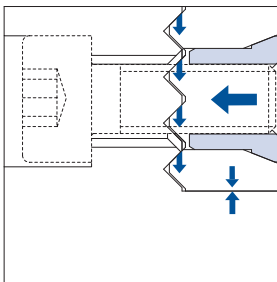
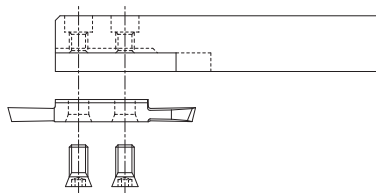

Serrage type B*
Spannsystem Typ B*
Clamping system type B*

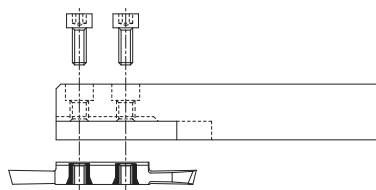

ajouter -B après le numéro d'article
 -B nach der Artikelreferenz hinzufügen
 add -B after the article number

Changement de la plaquette possible dans la machine, sans démontage du porte-outil
 WSP-Austauschmöglichkeit in der Maschine ohne Halterausbau
 The insert can be changed in the machine without removing the tool holder

700-ZX geometries

Très bonne maîtrise du copeau
pour matières difficiles

Sehr gute Spankontrolle für
schwierige Werkstoffe

Very efficient chip control for
difficult materials



Multitude de géométries possibles

Mehrere mögliche Spangeometrien

Many different cutting geometries are possible

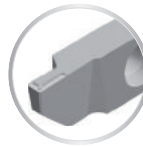

700-honed



Géométrie positive 5° avec arête de coupe renforcée (honnée)
Meilleure durée de vie dans l'usinage des matériaux abrasifs (aciers au carbone, aciers alliés)

Positive Geometrie 5° mit verstärkte Schneidkante (gehont)
Bessere Standzeit für die Bearbeitung von abrasive Materialien (Kohlenstoff Stahl, legierter Stahl)

Positive geometry 5° with reinforced cutting edge (honed)
Better tool life for abrasive materials (carbon steel, alloy steel)

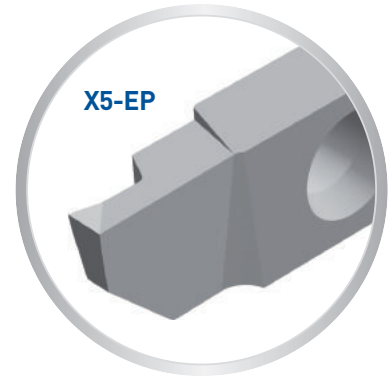





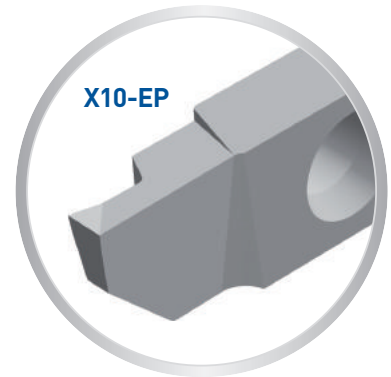

Géométrie positive 10° avec arête de coupe renforcée (honnée)
Meilleure durée de vie dans l'usinage des matériaux tenace (acier inox, inox martensitique)

Positive Geometrie 10° mit verstärkte Schneidkante (gehont)
Bessere Standzeit für die Bearbeitung von zähe Materialien (Rostfreier Stahl, martensitische Rostfreier Stahl)

Positive geometry 10° with reinforced cutting edge (honed)
Better tool life for tough materials (stainless steel, martensitic steel)



Géométries de coupe Spanformgeometrien Cutting geometries		Acier de décolletage Automatenstahl Free-cutting steel	Acier Stahl Steel	Acier inoxydable Rostfreistahl Stainless steel	Aluminium	Titane Titan Titanium	Laiton, bronze Messing, Bronze Brass, bronze	Cuivre Kupfer Copper	★	1 ^{er} choix 1. Wahl 1 st choice
									☆	Recommandé Empfohlen Recommended
									☑	Pour pièces fragiles de très petits diamètres Für empfindliche und sehr kleine Werkstücke For fragile and very small work pieces
	0°	★	☑	☑	☑	☑	★	☑	★	Permet un réaffûtage aisé Erlaubt einfaches Nachschleifen Allows easy regrinding
	X4°	★	★	★	☑	☑		☑	★	Réduit l'effort de coupe, réaffûtable Reduziert Schneidkräfte, nachschleifbar Decreases cutting force, allows regrinding
	XF	☆	★	★				☆	★	Pour matières difficiles (pointe renforcée) Für schwierige Werkstoffe (verstärkte Spitze) For difficult materials (reinforced point)
	X12°			☆	★	★		★	★	Très bonne maîtrise du copeau Sehr gute Spankontrolle Very efficient chip control
	X25°			☆	★	☆		☆	★	Pour matières collantes faisant de très longs copeaux Für klebrige Werkstoffe mit sehr langen Spänen For long chipping sticky materials
	U	☆	☆	☆					★	Pour resserrer le copeau, réaffûtage aisé Für Spanverschmälerung, einfaches Nachschleifen To narrow the chips, easy regrinding
	ZU8	★	★	★	☆ <5% Si	☆	☆	☆	★	Très bonne maîtrise du copeau (arête de coupe honée) Sehr gute Spankontrolle (gehönte Schneidkante) Very efficient chip control (honed edge) f min: 0.02 mm/U

Conseils d'utilisation

Anwendungsempfehlungen













Application recommendations

Tournage

Drehen

Turning

700 Series

Géométries de coupe Spannformgeometrien Cutting geometries		Acier de décolletage Automatenstahl Free-cutting steel	Acier Stahl Steel	Acier inoxydable Rostfreistahl Stainless steel	Aluminium	Titane Titan Titanium	Laiton, bronze Messing, Bronze Brass, bronze	Cuivre Kupfer Copper	★	1 ^{er} choix 1. Wahl 1 st choice
									☆	Recommandé Empfohlen Recommended
									⊗	Pour pièces fragiles de très petits diamètres Für empfindliche und sehr kleine Werkstücke For fragile and very small work pieces
	0°	★	⊗	⊗	⊗	⊗	★	⊗		Permet un réaffûtage aisé Erlaubt einfaches Nachschleifen Allows easy regrinding
	X	★	★	★	★	★		★		Très bonne maîtrise du copeau Sehr gute Spankontrolle Very efficient chip control
	X5-EP	★	★	☆						Très bonne maîtrise du copeau (arête de coupe honée) Sehr gute Spankontrolle (gehonte Schneidkante) Very efficient chip control (honed edge) f min: 0.02 mm/U
	X10-EP	☆	☆	★	☆	☆				Très bonne maîtrise du copeau (arête de coupe honée) Sehr gute Spankontrolle (gehonte Schneidkante) Very efficient chip control (honed edge) f min: 0.02 mm/U
	VX800	★	★	☆	☆	☆		☆		Très bonne maîtrise du copeau Sehr gute Spankontrolle Very efficient chip control
	VX8°	★	★	☆	☆	☆		☆		Très bonne maîtrise du copeau Sehr gute Spankontrolle Very efficient chip control
	VUX	☆	☆	★	☆	★		☆		Roule-copeau bidirectionnel Bidirektionaler Spanroller Bi-directional chip-breaker
	VX15°	☆		☆	★	★		★		Très bonne maîtrise du copeau Sehr gute Spankontrolle Very efficient chip control
	VS	☆		☆	⊗	⊗		⊗		Brise-copeau pour usinage léger en finition Spanbrecher für leichte Schlichtbearbeitung Chip-breaker for light finishing operation
	ZX10	★	★	★	☆ <5% Si	☆	☆			Très bonne maîtrise du copeau Sehr gute Spankontrolle Very efficient chip control f min: 0.02 mm/U
	ZX17			☆	★ <5% Si	★		★		Très bonne maîtrise du copeau Sehr gute Spankontrolle Very efficient chip control f min: 0.02 mm/U
	ZX25			☆	★ <5% Si	★		★		Très bonne maîtrise du copeau Sehr gute Spankontrolle Very efficient chip control f min: 0.02 mm/U
	ZXT	★	★	★	☆ <5% Si	☆	☆			Très bonne maîtrise du copeau Sehr gute Spankontrolle Very efficient chip control f min: 0.02 mm/U

<h3>TiAlN</h3> <p>μK20 + revêtement PVD μK20 + PVD Beschichtung μK20 + PVD coating</p>	<h3>TiAlX</h3> <p>μK20 + revêtement PVD μK20 + PVD Beschichtung μK20 + PVD coating</p>	<h3>TiN</h3> <p>μK20 + revêtement PVD μK20 + PVD Beschichtung μK20 + PVD coating</p>
<ul style="list-style-type: none"> excellente nuance universelle 1^{er} choix pour l'usinage des aciers, aciers inoxydables et alliages de titane très bonne résistance à la température 	<ul style="list-style-type: none"> nuance très résistante à l'usure et à la température, recommandée pour l'usinage des matières suivantes: Inox 304, 316L, 317L, 904, Phynox aciers alliés contenant: Chrome Nickel, Vanadium, Molybdène, ... 	<ul style="list-style-type: none"> nuance pour l'usinage des matières peu résistantes qui créent des arêtes rapportées très faible coefficient de frottement à éviter pour l'usinage du titane
<ul style="list-style-type: none"> beste Universalsorte für die Bearbeitung von Stahl, rostfreier Stahl und Titanlegierungen bestens geeignet sehr gute Warmfestigkeit 	<ul style="list-style-type: none"> sehr verschleissfeste und temperaturbeständige Sorte. Für folgende Materialien empfohlen: Inox 304, 316L, 317L, 904, Phynox legierter Stahl enthaltend: Chrom-Nickel, Vanadium, Molybdän, ... 	<ul style="list-style-type: none"> Sorte für die Bearbeitung von weichen Werkstoffen mit Tendenz zur Bildung von Aufbauschnitten sehr geringer Reibwert für die Bearbeitung von Titan nicht geeignet
<ul style="list-style-type: none"> best universal grade first choice for steel, stainless steel and titanium alloys machining very good heat resistance 	<ul style="list-style-type: none"> very wear and high temperature resistant grade. Recommended for following material: Inox 304, 316L, 317L, 904, Phynox alloy steel containing: Chrome-nickel, Vanadium, Molybdenum, ... 	<ul style="list-style-type: none"> grade for the machining of low resistance materials which creates build-up edge very low friction ratio not suitable for titanium machining

<h3>LOX</h3> <p>μK20 + revêtement PVD μK20 + PVD Beschichtung μK20 + PVD coating</p>	<h3>N (μK20)</h3> <p>non revêtu unbeschichtet uncoated</p>
<ul style="list-style-type: none"> nuance résistante à l'usure et à la température, destinée à l'usinage des matières suivantes: Inox, Titanes, alliages à base de Nickel, Chrome Cobalt, les matières avec une dureté supérieure à > 50HRC bonne alternative pour l'usinage des aciers de construction types ETG88, ETG100, 36SMnPb14 	<ul style="list-style-type: none"> supporte les coupes interrompues et autres conditions d'usinage défavorables
<ul style="list-style-type: none"> verschleissfeste und temperaturbeständige Sorte. Für folgende Materialien empfohlen: Inox, Titan, Nickellegierungen, Chrom-Kobalt, Materialien härter als > 50HRC gute Alternative für die Bearbeitung von Baustähle Typ ETG88, ETG100, 36SMnPb14 	<ul style="list-style-type: none"> für unterbrochene Schnitte und andere ungünstige Bearbeitungsbedingungen geeignet
<ul style="list-style-type: none"> wear and high temperature resistant grade. Recommended for following materials: inox, titanium, nickel alloys, materials harder than > 50HRC good alternative for machining of structural steels type ETG88, ETG100, 36SMnPb14 	<ul style="list-style-type: none"> suitable for interrupted cut and other unfavourable machining conditions

Nuances micro-grain à dureté élevée

Verschleissfeste Feinkornsorten

Wear resistant micro-grain grades

μK 10

HTA

μK10 + revêtement PVD
μK10 + PVD Beschichtung
μK10 + PVD coating

- nuance très résistante à l'usure
- pour l'usinage en finition dans des conditions favorables des aciers, aciers inoxydables et alliages de titane

- sehr verschleissfeste Sorte
- für die Feinbearbeitung von Stahl, rostfreiem Stahl und Titanlegierungen bei guten Bearbeitungsbedingungen

- very wear resistant grade
- for light machining of steel, stainless steel and titanium alloys under favourable machining conditions

HTAX

μK10 + revêtement PVD
μK10 + PVD Beschichtung
μK10 + PVD coating

- nuance très résistante à l'usure et à la température, pour l'usinage en finition avec faibles avances de petites pièces, recommandée pour l'usinage des matières suivantes: Inox 304, 316L, 317L, 904, Phynox
- aciers alliés contenant: Chrome Nickel, Vanadium, Molybdène, ...

- sehr verschleissfeste und temperaturbeständige Sorte. Für Feinbearbeitung von kleinen Teilen mit geringer Vorschub. Für folgende Materialien empfohlen: Inox 304, 316L, 317L, 904, Phynox
- legierter Stahl enthaltend: Chrom-Nickel, Vanadium, Molybdän, ...

- very wear and high temperature resistant grade. For light machining of small parts with low cutting feed. Recommended for following material: Inox 304, 316L, 317L, 904, Phynox
- alloy steel containing: Chrome-nickel, Vanadium, Molybdenum, ...

HTiN

μK10 + revêtement PVD
μK10 + PVD Beschichtung
μK10 + PVD coating

- nuance pour l'usinage en finition des matières peu résistantes qui créent des arêtes rapportées
- très faible coefficient de frottement
- à éviter pour l'usinage du titane

- Sorte für die Feinbearbeitung von weichen Werkstoffen mit Tendenz zur Bildung von Aufbauschneiden
- sehr geringer Reibwert
- für die Bearbeitung von Titan nicht geeignet

- grade for light machining of low resistance materials which creates build-up edge
- very low friction ratio
- not suitable for titanium machining

HAS

μK10 + revêtement PVD
μK10 + PVD Beschichtung
μK10 + PVD coating

- nuance pour métaux non ferreux
- très faible coefficient de frottement
- 1^{er} choix pour l'usinage des aluminiums jusqu'à 5% Si, des cuivres et titanes faiblement alliés

- Sorte für Nichteisenmetalle
- sehr geringer Reibwert
- für die Bearbeitung von Aluminium bis 5% Si, Kupfer und niedriglegiertem Titan bestens geeignet

- grade for non-ferrous materials
- very low friction ratio
- first choice for aluminium up to 5% Si, copper and low alloyed titanium

HN (μK10)

non revêtu
unbeschichtet
uncoated

- nuance micro-grain très résistante à l'usure
- recommandé pour l'usinage du titane faiblement allié
- déconseillé en cas de coupe interrompue et autres conditions d'usinage défavorables

- verschleissfeste Feinkornsorte
- für die Bearbeitung von niedrig legiertem Titan empfehlenswert
- für unterbrochene Schnitte und andere ungünstige Bearbeitungsbedingungen nicht geeignet

- wear resistant micro-grain grade
- suitable for the machining of low alloyed titanium
- not suitable for interrupted cut and other unfavourable machining conditions

Paramètres de coupe indicatifs

Empfohlene Schnittwerte

Standard machining data

Matière Werkstoff Material	Tournage Drehen Turning			Tronçonnage Abstechen Parting off		
	VC	Prof. de passe Schnitttiefe Depth of cut	Avance Vorschub Feed	VC	Largeur de coupe Abstechbreite Cutting width	Avance Vorschub Feed
	(m/min)	(mm)	(mm/U)	(m/min)	(mm)	(mm/U)
Acier de décolletage Automatenstahl Free-cutting steel P	120 - 200	0.05 - 1.0 1.0 - 4.0	0.01 - 0.15 0.05 - 0.25	80 - 150	0.50 - 1.50 1.50 - 3.50	0.01 - 0.08 0.03 - 0.15
Acier Stahl < 600 N/mm ² P	80 - 160	0.05 - 1.0 1.0 - 4.0	0.01 - 0.15 0.05 - 0.25	70 - 120	0.50 - 1.50 1.50 - 3.50	0.01 - 0.06 0.03 - 0.12
Acier Stahl < 800 N/mm ² P	60 - 120	0.05 - 1.0 1.0 - 4.0	0.01 - 0.10 0.05 - 0.20	60 - 100	0.50 - 1.50 1.50 - 3.50	0.01 - 0.05 0.03 - 0.10
Acier Stahl > 800 N/mm ² P	50 - 100	0.05 - 1.0 1.0 - 3.0	0.01 - 0.08 0.05 - 0.15	40 - 80	0.50 - 1.50 1.50 - 3.50	0.01 - 0.04 0.03 - 0.08
Acier inoxydable Rostfreistahl Stainless steel M	60 - 120	0.05 - 1.0 1.0 - 3.0	0.01 - 0.08 0.05 - 0.15	60 - 100	0.50 - 1.50 1.50 - 3.50	0.01 - 0.04 0.03 - 0.08
Aluminium Si <12% N	200 - 1000	0.05 - 1.0 1.0 - 4.0	0.01 - 0.20 0.05 - 0.40	180 - 400	0.50 - 1.50 1.50 - 3.50	0.01 - 0.10 0.03 - 0.20
Aluminium Si >12% N	180 - 800	0.05 - 1.0 1.0 - 4.0	0.01 - 0.20 0.05 - 0.40	150 - 300	0.50 - 1.50 1.50 - 3.50	0.01 - 0.10 0.03 - 0.20
Cuivre, laiton, bronze Kupfer, Messing, Bronze Copper, brass, bronze N	100 - 500	0.05 - 1.0 1.0 - 4.0	0.01 - 0.20 0.05 - 0.35	100 - 300	0.50 - 1.50 1.50 - 3.50	0.01 - 0.10 0.03 - 0.20
Titane Titan Titanium S	30 - 70	0.05 - 1.0 1.0 - 4.0	0.01 - 0.08 0.05 - 0.15	30 - 50	0.50 - 1.50 1.50 - 3.50	0.01 - 0.03 0.03 - 0.06

Indications pour premier réglage
Hinweise für die erste Einrichtung
Indications for first setting

Ébauche Schruppen Roughing	Finition Schlichten Finishing
<ul style="list-style-type: none"> • vitesse de coupe moyenne • avance élevée 	<ul style="list-style-type: none"> • vitesse de coupe élevée • avance faible
<ul style="list-style-type: none"> • durchschnittliche Schnittgeschwindigkeit • hohe Schnittgeschwindigkeit 	<ul style="list-style-type: none"> • hohe Schnittgeschwindigkeit • niedriger Vorschub
<ul style="list-style-type: none"> • average cutting speed • high cutting speed 	<ul style="list-style-type: none"> • high cutting speed • low cutting feed

Remarques importantes
Wichtige Bemerkungen
Important remarks

- en raison des limites de la machine, il n'est souvent pas possible d'atteindre les vitesses de coupe préconisées
- les outils Applitec sont spécialement développés pour permettre de hautes performances, même dans des conditions de coupe défavorables
- des applications non préconisées dans le tableau ci-contre peuvent également s'avérer efficaces

- wegen begrenzter Maschinenleistung ist es oft nicht möglich, die vorgeschlagenen Schnittgeschwindigkeiten zu erreichen
- Applitec Werkzeuge sind besonders dazu entwickelt, um sogar bei ungünstigen Schnittdaten leistungsfähig zu sein
- die in der nebenstehender Tabelle nicht erwähnten Anwendungsfälle können sich auch effizient erweisen

- in many cases, it is impossible to reach the recommended cutting speed, due to the machine limits
- Applitec tools are especially designed to be efficient even in bad cutting conditions
- applications not mentioned in the opposite table can also be efficient

L		R	
Type	Page	Type	Page
710	1.14	720	1.14
710-NOVIBRA	1.15	721	1.16
711	1.16	721-EP	1.23
711-EP	1.23	722	1.17
712	1.17	723-30	1.18
713-30	1.18	723-45	1.19
713-45	1.19	723-60	1.20
713-60	1.20	724	1.21
714	1.21	726	1.22
716	1.22		

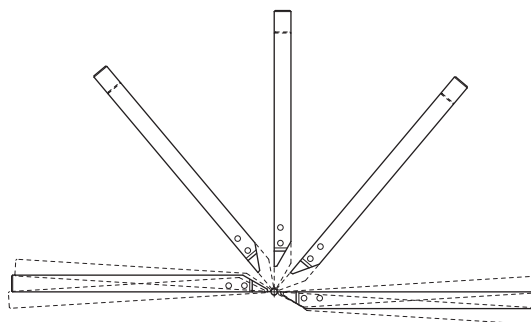

Porte-outils et plaquettes pour machines à cames
 Halter und WSP für kurvengesteuerte Maschinen
 Tool holders and inserts for cam driven machines

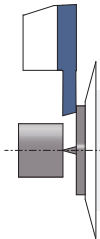
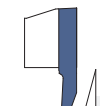
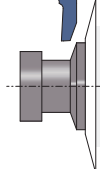
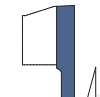
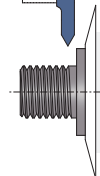
		710 / 720 Porte-outils Halter Holders	> 1.14
	711 / 721 Tronçonnage Abstechen Parting off		> 1.16
		712 / 722 Tournage avant Vorwärts drehen Front turning	> 1.17
	713 / 723 Tournage arrière Rückwärts drehen Back turning		> 1.18
		714 / 724 Fonçage-tournage Einstechen und drehen Grooving and turning	> 1.21
	716 / 726 Filetage Gewinde drehen Threading		> 1.22
		Plaquette ébauche WSP-Rohling Blank insert	> 1.23

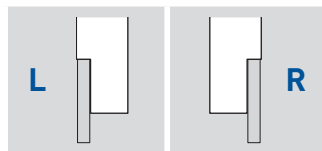
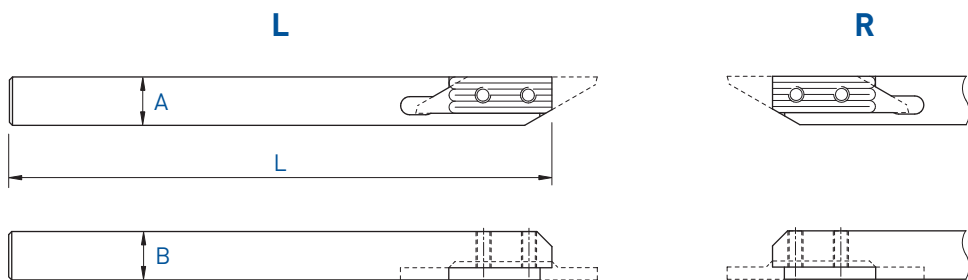

A x B	L	Serrage Spannsystem Clamping	Art. N°	Art. N°
6 x 6	115	A	710-6	-
7 x 7	115	A	710-7	720-7
8 x 8	115	A	710-8	720-8
8 x 8	140	A	710-8-140	-
10 x 10	115	A	710-10	720-10
12 x 12	130	A	710-12	720-12



Chaque support est livré avec vis et clé.
 Jeder Halter wird mit Spannschraube(n) und Schlüssel geliefert.
 Screw(s) and key are included with each tool holder.

Porte-outils en métal lourd anti-vibratoire
 Schwingungsdämpfende Schwermetallhalter
 Low vibration heavy metal holders

710-NOVIBRA

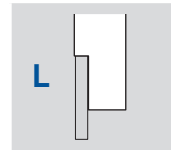
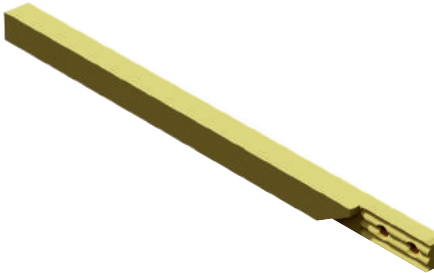
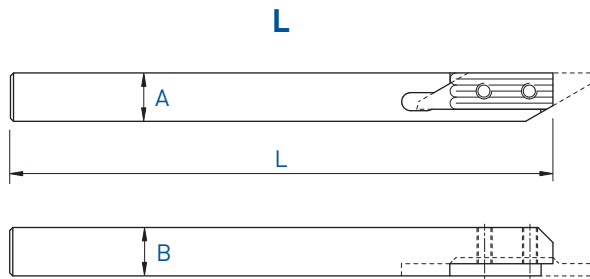

A x B	L	Serrage Spannsystem Clamping	Art. N°
6 x 6	115	A	710-6-NOVIBRA
7 x 7	115	A	710-7-NOVIBRA
8 x 8	115	A	710-8-NOVIBRA



Chaque support est livré avec vis et clé.
 Jeder Halter wird mit Spannschraube(n) und Schlüssel geliefert.
 Screw(s) and key are included with each tool holder.

L

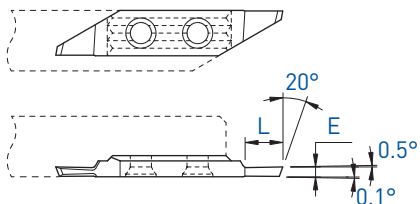

R

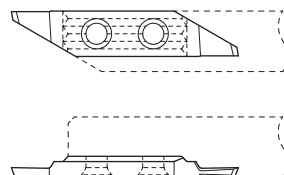

L



R



E	L	Art. N°	L			R			Art. N°	R					
			TiAlN	TiN	N (µk20)	HTA	HTiN	HN (µk10)		TiAlN	TiN	N (µk20)	HTA	HTiN	HN (µk10)
0.5	2	711-0.5	■	■	■	■	□	■	-						
0.8	3	711-0.8	■	■	■	■	■	■	721-0.8	■	■	■			
0.9	3	711-0.9	■	■	■	■	□	■	-						
1.0	4	711-1.0	■	■	■	■	■	■	721-1.0	■	■	■	■	□	■
1.1	4	711-1.1	■	■	■	■	■	■	-						
1.2	5	711-1.2	■	■	■	■	■	■	721-1.2	■	■	■	■	□	■
1.3	5	711-1.3	■	■	■	■	□	■	-						
1.4	5	711-1.4	■	■	■				-						
1.5	6.5	711-1.5	■	■	■	■	■	■	721-1.5	■	■	■	■	□	■
1.8	6.5	711-1.8	■	■	■	■	□	■	721-1.8	■	■	■			
2.0	6.5	711-2.0	■	■	■				721-2.0	■	■	■			

Tournage avant
Vorwärts drehen
Front turning

712 / 722

L

R

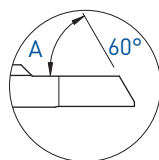
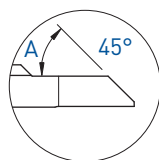
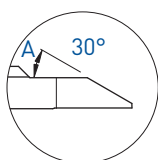
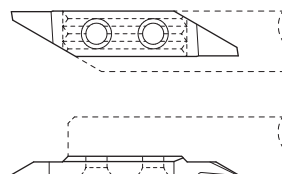
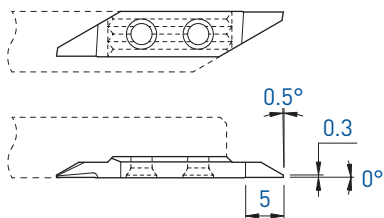

A	Art. N°	L						R						
		TiAlN	TiN	N (µk20)	HTA	HTIN	HN (µk10)	Art. N°	TiAlN	TiN	N (µk20)	HTA	HTIN	HN (µk10)
30°	712-30	■	■	■	■	□	■	722-30	■	■	■	■	□	■
45°	712-45	■	■	■	■	■	■	722-45	■	■	■	■	□	■
60°	712-60	■	■	■	■	■	■	722-60	■	■	■	■	□	■

TOP-LINE

Tournage arrière
Rückwärts drehen
Back turning

713-30° / 723-30°

L

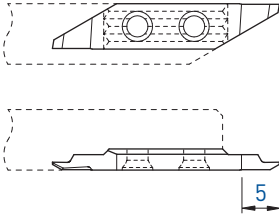

R

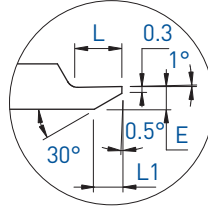
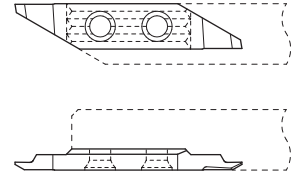

L



R



E	L	L1	Art. N°	TiAlN	TiN	N (µk20)	HTA	HTiN	HN (µk10)	Art. N°	TiAlN	TiN	N (µk20)	HTA	HTiN	HN (µk10)
0.8	1.6	0.85	713-30-0.8	■	■	■				723-30-0.8	■	■	■	■	□	■
0.9	1.6	1.05	713-30-0.9	■	■	■				-						
1.0	2.0	1.2	713-30-1.0	■	■	■	■	□	■	723-30-1.0	■	■	■	■	□	■
1.1	2.0	1.4	713-30-1.1	■	■	■				-						
1.2	2.5	1.55	713-30-1.2	■	■	■				723-30-1.2	■	■	■			
1.3	2.5	1.7	713-30-1.3	■	■	■				-						
1.4	3.0	1.9	713-30-1.4	■	■	■				-						
1.5	3.0	2.1	713-30-1.5	■	■	■	■	■	■	723-30-1.5	■	■	■			
1.8	4.0	2.6	713-30-1.8	■	■	■				723-30-1.8	■	■	■			
2.0	4.0	2.9	713-30-2.0	■	■	■	■	■	■	723-30-2.0	■	■	■			

Tournage arrière
 Rückwärts drehen
 Back turning

713-45° / 723-45°

L

R

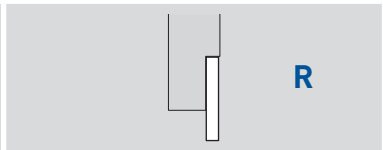
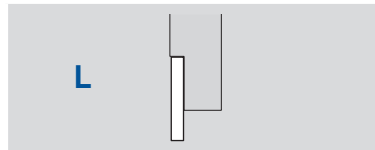
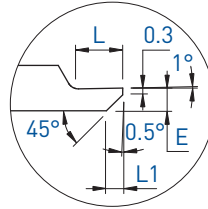
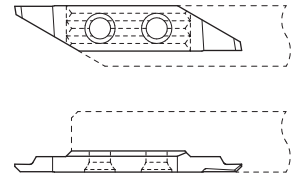
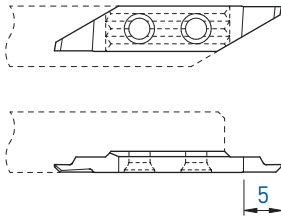

E	L	L1	Art. N°	L			R									
				TiAlN	TiN	N (µk20)	HTA	HTiN	HN (µk10)	Art. N°	TiAlN	TiN	N (µk20)	HTA	HTiN	HN (µk10)
0.8	1.6	0.5	713-45-0.8	■	■	■	■	□	■	723-45-0.8	■	■	■			
0.9	1.6	0.6	713-45-0.9	■	■	■				-						
1.0	2.0	0.7	713-45-1.0	■	■	■	■	□	■	723-45-1.0	■	□	■			
1.1	2.0	0.8	713-45-1.1	■	■	■				-						
1.2	2.5	0.9	713-45-1.2	■	■	■				723-45-1.2	■	■	■			
1.3	2.5	1.0	713-45-1.3	■	■	■				-						
1.4	3.0	1.1	713-45-1.4	■	■	■				-						
1.5	3.0	1.2	713-45-1.5	■	■	■	■	■	■	723-45-1.5	■	□	■			
1.8	4.0	1.5	713-45-1.8	■	■	■				723-45-1.8	■	□	■			
2.0	4.0	1.7	713-45-2.0	■	■	■				723-45-2.0	■	■	■			

■ = disponible / verfügbar / available
 □ = selon disponibilité du stock / jenach Lagerverfügbarkeit / depending on stock availability

L

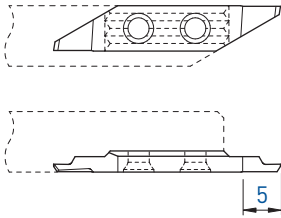

R

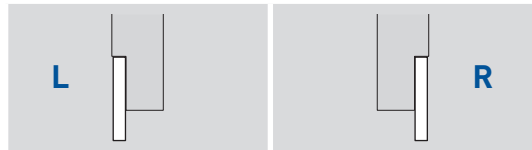
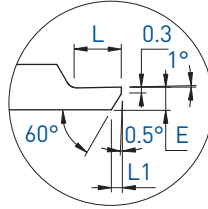
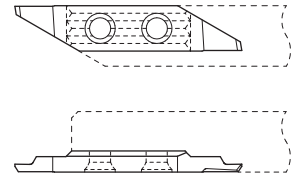

E	L	L1	Art. N°	TiAlN	TiN	N (µk20)	Art. N°	TiAlN	TiN	N (µk20)
0.8	1.6	0.3	713-60-0.8	■	■	■	723-60-0.8	■	■	■
0.9	1.6	0.35	713-60-0.9	■	■	■	-			
1.0	2.0	0.4	713-60-1.0	■	■	■	723-60-1.0	■	□	■
1.1	2.0	0.45	713-60-1.1	■	■	■	-			
1.2	2.5	0.5	713-60-1.2	■	■	■	723-60-1.2	■	□	■
1.3	2.5	0.6	713-60-1.3	■	■	■	-			
1.4	3.0	0.65	713-60-1.4	■	■	■	-			
1.5	3.0	0.7	713-60-1.5	■	■	■	723-60-1.5	■	■	■
1.8	4.0	0.9	713-60-1.8	■	■	■	723-60-1.8	■	□	■
2.0	4.0	1.0	713-60-2.0	■	■	■	723-60-2.0	■	■	■

Fonçage-tournage

Einstecken und drehen

Grooving and turning

714 / 724

L

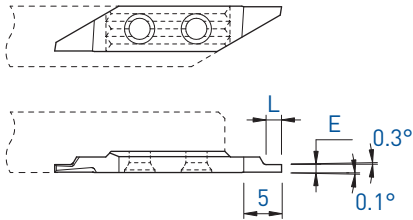

R

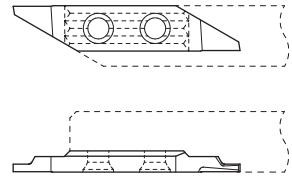

L

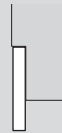

R



E	L	Art. N°	TiAlN	TiN	N (µk20)	HTA	HTiN	HN (µk10)	Art. N°	TiAlN	TiN	N (µk20)	HTA	HTiN	HN (µk10)
0.5	1.0	714-0.5	■	■	■				724-0.5	■	■	■	■	□	■
0.6	1.0	714-0.6	■	■	■				724-0.6	■	■	■			
0.7	1.5	714-0.7	■	■	■				724-0.7	■	■	■			
0.8	1.5	714-0.8	■	■	■	■	□	■	724-0.8	■	■	■			
0.9	2.0	714-0.9	■	■	■				724-0.9	■	□	■			
1.0	2.0	714-1.0	■	■	■	■	■	■	724-1.0	■	■	■			
1.1	2.0	714-1.1	■	■	■				724-1.1	■	□	■			
1.2	2.5	714-1.2	■	■	■				724-1.2	■	□	■			
1.3	2.5	714-1.3	■	■	■				724-1.3	■	■	■			
1.4	3.0	714-1.4	■	■	■				724-1.4	■	□	■			
1.5	3.0	714-1.5	■	■	■	■	■	■	724-1.5	■	■	■			

■ = disponible / verfügbar / available

□ = selon disponibilité du stock / jenach Lagerverfügbarkeit / depending on stock availability

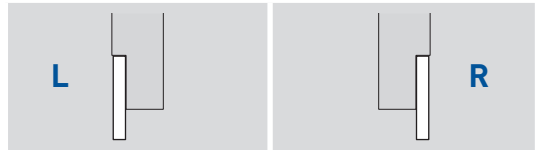
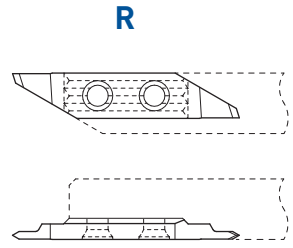
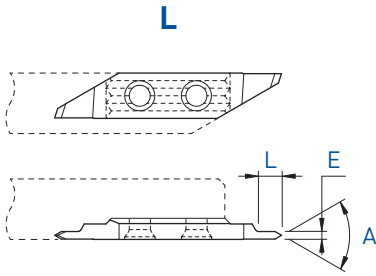

A	E	L	Art. N°	TiAlN	TiN	N (µk20)	Art. N°	TiAlN	TiN	N (µk20)
60°	1.0	3	716-60-1.0	■	■	■	726-60-1.0	■	■	■
60°	1.5	4	716-60-1.5	■	■	■	726-60-1.5	■	■	■
55°	1.0	3	716-55-1.0	■	■	■	726-55-1.0	■	□	■
55°	1.5	4	716-55-1.5	■	■	■	726-55-1.5	■	□	■

Plaquettes ébauches

WSP-Rohlinge

Blank inserts

711-EP / 721-EP

L

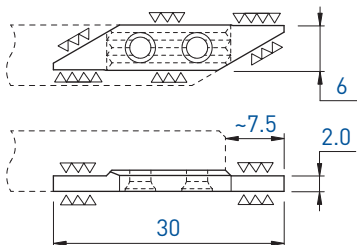

R

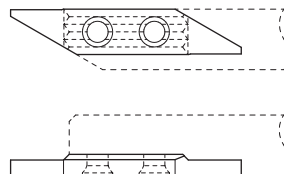

L		R			
Art. N°	TiAlN TiN N (µk20)	HTA HTiN HN (µk10)	Art. N°	TiAlN TiN N (µk20)	HTA HTiN HN (µk10)
711-EP	■ ■ ■	■ □ ■	721-EP	■ □ ■	□ □ ■

L			R		
Type		Page	Type		Page
730	730	1.26	740	740	1.26
	730-JET	1.27		740/730-D	1.31
	730-NOVIBRA	1.30		740-C	1.28
	730RC	1.29		740-JET	1.27
731	731	1.32		740-NOVIBRA	1.30
	731-E	1.67	741	741	1.32
	731N	1.38/1.45		741-E	1.67
	731R	1.39		741L	1.39
	731RU	1.44		741LX12	1.42
	731RX12	1.42		741LX25	1.43
	731RX25	1.43		741LX4	1.40
	731RX4	1.40		741LXF	1.41
	731RXF	1.41		741N	1.38/1.45
	731U	1.37		741U	1.37
	731X12	1.35		741X12	1.35
	731X25	1.36		741X25	1.36
	731X4	1.33		741X4	1.33
	731XF	1.34		741XF	1.34
732	732	1.46	742	742	1.46
	732PX	1.47		742PX	1.47
	732X	1.48		742X	1.48
733	733	1.49	743	743	1.49
	733P	1.55		743P	1.55
	733VX-15°	1.53		743VX-15°	1.53
	733VX-8°	1.51		743VX-8°	1.51
	733VX-805	1.52		743VX-805	1.52
	733X	1.50		743X	1.50
	733ZX	1.54		743ZX10	1.54
734	734	1.56	744	744	1.56
	734VS	1.57		744VS	1.57
	734X	1.58		744X	1.58
	734ZX	1.59		744ZX	1.59
735	735	1.61		744ZXT	1.60
	735X-90	1.62	745	745	1.61
736	736	1.63		745X-90	1.62
	736-A60°	1.64	746	746	1.63
	736-M	1.65		746-A60°	1.64
737	737	1.66		746-M	1.65
			747	747	1.66

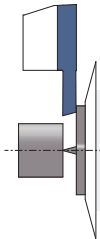
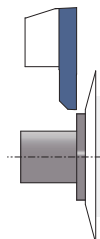
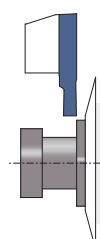
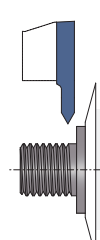
		730 / 740 Porte-outils Halter Holders	> 1.26
	731 / 741 Tronçonnage Abstechen Parting off		> 1.32
		741L / 731R Tronçonnage - coupe déportée Abstechen - versetztes Schneiden Parting off - cut off line	> 1.39
	732 / 742 Tournage avant Vorwärts drehen Front turning		> 1.46
		733 / 743 Tournage arrière Rückwärts drehen Back turning	> 1.49
	734 / 744 Fonçage-tournage Einstechen und drehen Grooving and turning		> 1.56
		735 / 745 Gorges Einstechen Grooving	> 1.61
	736 / 746 Filetage Gewinde drehen Threading		> 1.63
		737 / 747 Plaquettes à rayon Radius Wendeplatten Radius inserts	> 1.66
	Plaquettes ébauches WSP-Rohlinge Blank inserts		> 1.67

L

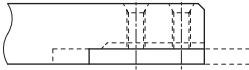
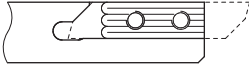

R

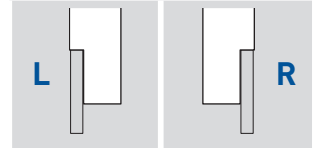
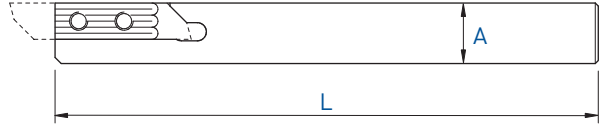

Serrage standard A
Standard Spannsystem A
Standard clamping system A

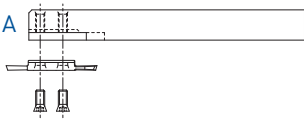

Serrage B
Spannsystem B
Clamping system B

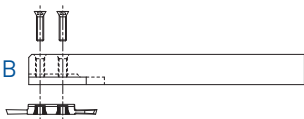

A x B	L	Serrage Spannsystem Clamping	Art. N°	Art. N°
7 x 7	115	A	730-7	740-7
8 x 8	115	A + B	730-8	740-8
8 x 8	140	A + B	730-8-140	-
10 x 10	115	A + B	730-10	740-10
10 x 10	50	A + B	730-10-50	740-10-50
12 x 12	130	A + B	730-12	740-12
12 x 12	90	A + B	730-12-90	740-12-90
12.7 x 12.7	130	A + B	730-12.7	740-12.7
16 x 16	130	A + B	730-16	740-16
16 x 16	75	A + B	730-16-75	740-16-75
20 x 20	120	A + B	730-20	740-20

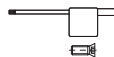

Chaque support est livré avec vis et clé.
Jeder Halter wird mit Spannschraube(n) und Schlüssel geliefert.
Screw(s) and key are included with each tool holder.

Porte-outils avec arrosage intégré
 Halter mit integrierter Kühlmittelzufuhr
 Holders with integrated coolant supply

730-JET / 740-JET

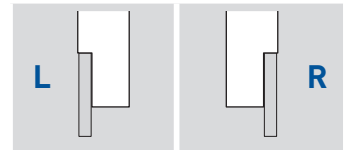
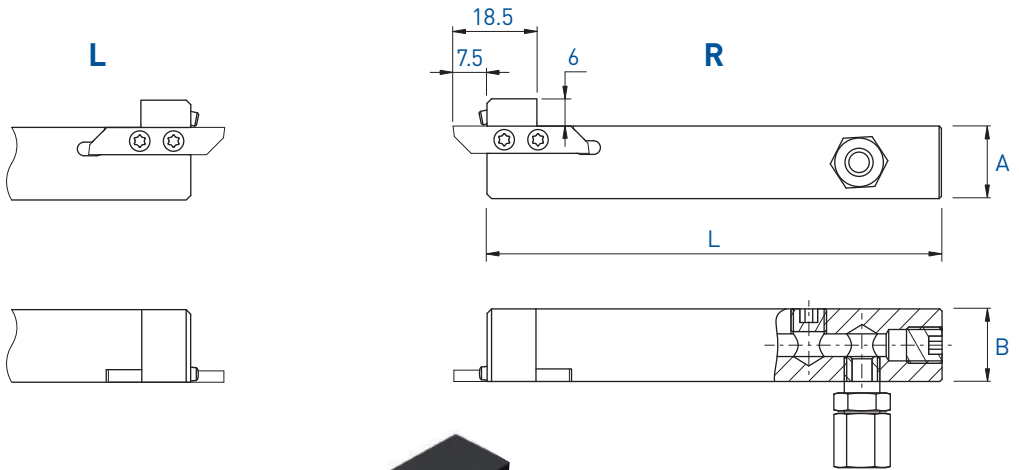

A x B	L	Serrage Spannsystem Clamping	Art. N°	Art. N°
8 x 10	100	A + B	-	740-0810-JET
10 x 12	100	A + B	730-1012-JET	740-1012-JET
10 x 12	80	A + B	-	740-1012-80-JET new
12 x 12	100	A + B	730-12-JET	740-12-JET
12.7 x 12.7	100	A + B	730-12.7-JET	740-12.7-JET
16 x 16	100	A + B	730-16-JET	740-16-JET
20 x 20	100	A + B	730-20-JET	740-20-JET



Pièces de rechange Ersatzteile Spare parts	Art. N°	Art. N°	Buse Düse Nozzle Art. N°	Option Art. N°	
	740-0810-JET	J-M5-D5	JB-M5	-	JC-M5-D5
	730-JET / 740-JET	J-M8X1-D6	JB-M8X1	JJ-M3X6-D1.5	-

Chaque support est livré avec vis et clé.
 Jeder Halter wird mit Spannschraube(n) und Schlüssel geliefert.
 Screw(s) and key are included with each tool holder.



R

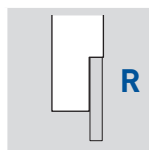
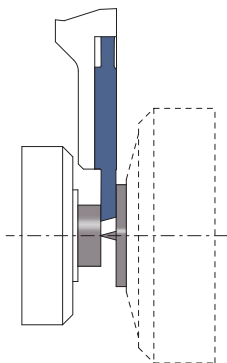
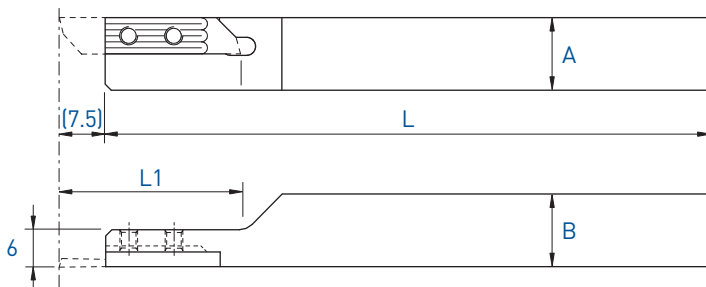

A x B	L	L1	Serrage Spannsystem Clamping	Art. N°
8 x 8	115	24	A	740-C-8
10 x 10	115	24	A	740-C-10
12 x 12	130	30	A	740-C-12
16 x 16	130	40	A	740-C-16

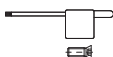

Chaque support est livré avec vis et clé.
Jeder Halter wird mit Spannschraube(n) und Schlüssel geliefert.
Screw(s) and key are included with each tool holder.

Porte-outils

Halter

Holders

Coupe à droite déportée

Versetztes Rechtsschneiden

Right cut off line

730RC

Utiliser des plaquettes type 731R
 WSP Typ 731R verwenden
 Use inserts type 731R

Voir pages 1.39 - 1.45
 Siehe Seiten 1.39 - 1.45
 See pages 1.39 - 1.45

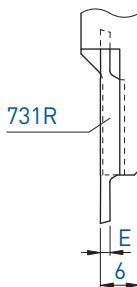
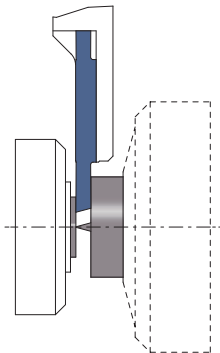
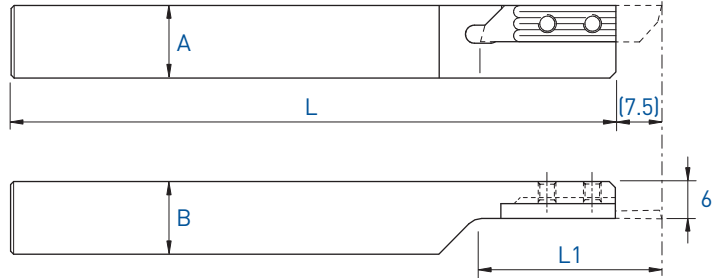
**L (R)**

Coupe à droite déportée
 Versetztes Rechtsschneiden
 Right cut off line



A x B	L	L1	Art. N°
8 x 8	115	24	730RC-8
10 x 10	115	24	730RC-10
12 x 12	130	30	730RC-12
16 x 16	130	40	730RC-16



Chaque support est livré avec vis et clé.
 Jeder Halter wird mit Spannschraube(n) und Schlüssel geliefert.
 Screw(s) and key are included with each tool holder.

Porte-outils en métal lourd anti-vibratoire
 Schwingungsdämpfende Schwermetallhalter
 Low vibration heavy metal holders

730-NOVIBRA
 740-NOVIBRA

L

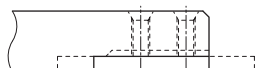
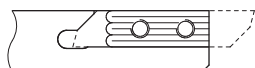

R

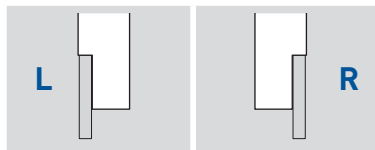
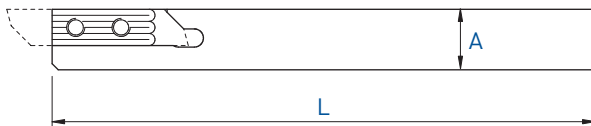

A x B	L	Serrage Spannsystem Clamping	Art. N°	Art. N°
7 x 7	115	A	730-7-NOVIBRA	740-7-NOVIBRA
8 x 8	115	A + B	730-8-NOVIBRA	740-8-NOVIBRA
8 x 8	80	A + B	-	740-8-80-NOVIBRA
10 x 10	115	A + B	-	740-10-NOVIBRA
12 x 12	130	A + B	-	740-12-NOVIBRA

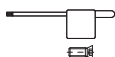

Chaque support est livré avec vis et clé.
 Jeder Halter wird mit Spannschraube(n) und Schlüssel geliefert.
 Screw(s) and key are included with each tool holder.

Porte-outils

Halter

Holders

740 / 730-D

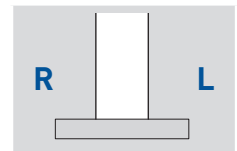
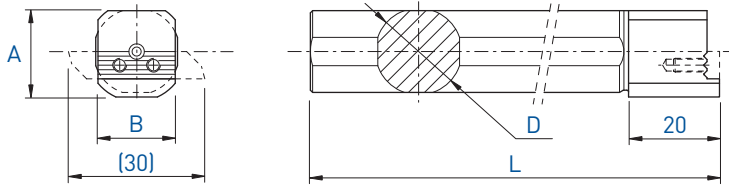

A x B	L	D	Art. N°
19 x 17	160	16	740/730-D16
19 x 17	160	19.05	740/730-D19.05
19 x 17	110	19.05	740/730-D19.05-S
19.5 x 17	160	20	740/730-D20
20 x 17	110	22	740/730-D22
22 x 17	200	25	740/730-D25
22 x 17	200	25.4	740/730-D25.4

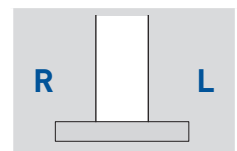
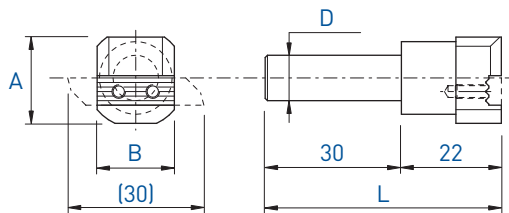

A x B	L	D	Art. N°
19 x 17	52	10	740/730-D10

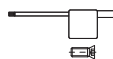

Chaque support est livré avec vis et clé.

Jeder Halter wird mit Spannschraube(n) und Schlüssel geliefert.

Screw(s) and key are included with each tool holder.

Tronçonnage
Abstechen
Parting off

731 / 741

L

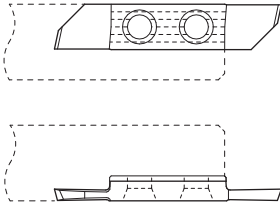

R

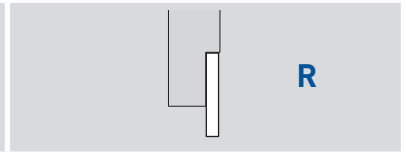
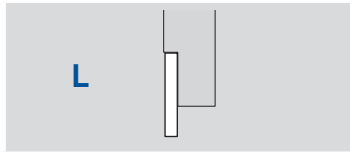
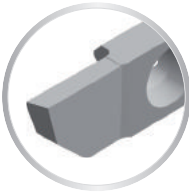
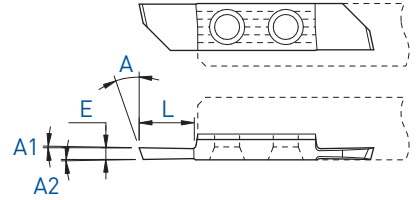

E	A	A1	A2	L	Art. N°	TiAlN	TiN	N (µk20)	HTA	HTiN	HN (µk10)	Art. N°	TiAlN	TiAlX	TiN	N (µk20)	HTA	HTiN	HN (µk10)		
0.6	18°	2.5°	0.5°	3	731-0.6	■	■	■	■	■	■	741-0.6	■	■	■	■	■	■	■	■	
0.8	20°	0.3°	0.3°	5	731-0.8	■	■	■	■	□	■	741-0.8	■	■	■	■	■	■	■	■	
1.0	20°	0.3°	0.3°	5	731-1.0	■	■	■	■	■	■	741-1.0	■	■	■	■	■	■	■	■	
1.2	20°	0.3°	0.3°	5	731-1.2	■	■	■	■	□	■	741-1.2	■	■	■	■	■	■	■	■	
1.5	20°	0.3°	0.3°	7	731-1.5	■	■	■	■	■	■	741-1.5	■	■	■	■	■	■	■	■	
1.8	20°	0.3°	0.3°	7	731-1.8	■	■	■	■	□	■	741-1.8	■	■	■	■	■	■	□	■	
2.0	20°	0.3°	0.3°	7	731-2.0	■	■	■	■	□	■	741-2.0	■	■	■	■	■	■	■	■	
2.5	20°	0.3°	0.3°	7	731-2.5	■	■	■	■	■	■	741-2.5	■	■	■	■	■	■	■	□	■

7XX-XX-B

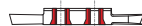

Sur demande pour serrage type B, voir page 1.03
Wahlweise mit B-Spannsystem, siehe Seite 1.03
On request for B clamping system, see page 1.03

Tronçonnage
Abstechen
Parting off

731X4 / 741X4

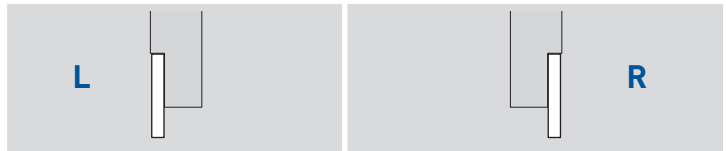
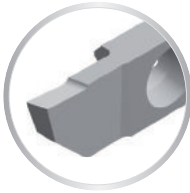
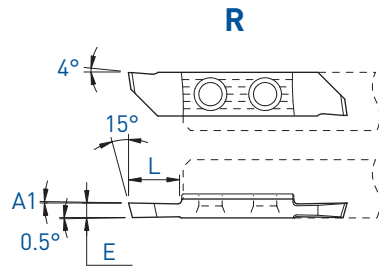
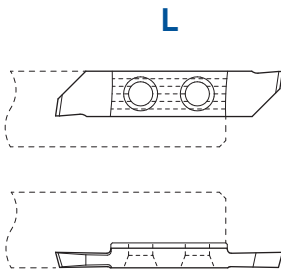

			L				R											
E	A1	L	Art. N°	TiAlN	TiN	N [µk20]	HTA	HTiN	HN [µk10]	Art. N°	TiAlN	TiAlX	TiN	N [µk20]	HTA	HTiN	HN [µk10]	
0.6	2.5°	3	731X4-0.6	■	■	■	■	■	■	741X4-0.6	■	■	■	■	■	■	■	■
0.8	0.5°	4	-							741X4-0.8					■	■	■	
1.0	0.5°	5	731X4-1.0	■	■	■				741X4-1.0	■	■	■	■	■	□	■	
1.5	0.5°	7	731X4-1.5	■	■	■	■	□	■	741X4-1.5	■	■	■	■	■	□	■	
2.0	0.5°	7	731X4-2.0	■	■	■				741X4-2.0	■	■	■	■				

7XX-XX-B

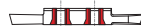

Sur demande pour serrage type B, voir page 1.03
Wahlweise mit B-Spannsystem, siehe Seite 1.03
On request for B clamping system, see page 1.03

■ = disponible / verfügbar / available
□ = selon disponibilité du stock / jenach Lagerverfügbarkeit / depending on stock availability

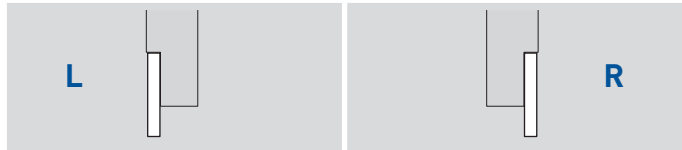
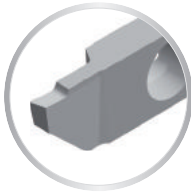
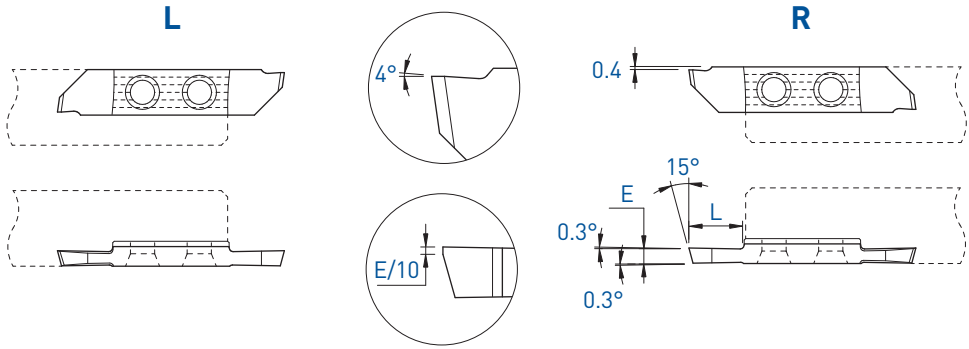

E	L	Art. N°	TiAlN			HTA			Art. N°	TiAlN			HTA		
			TiN	N (µk20)	HN (µk10)	HTiN	HN (µk10)	TiN		N (µk20)	HTiN	HN (µk10)			
1.2	5	-	■	■	■	■	■	■	741XF-1.2	■	□	■	■	■	■
1.5	7	731XF-1.5	■	■	■	■	■	■	741XF-1.5	■	■	■	■	■	■
2.0	7	731XF-2.0	■	■	■	■	■	■	741XF-2.0	■	■	■	■	■	■
2.5	7	731XF-2.5	■	■	■	■	■	■	741XF-2.5	■	■	■	■	■	■

7XX-XX-B

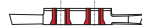

Sur demande pour serrage type B, voir page 1.03
Wahlweise mit B-Spannsystem, siehe Seite 1.03
On request for B clamping system, see page 1.03

Tronçonnage

Abstechen

Parting off

731X12 / 741X12

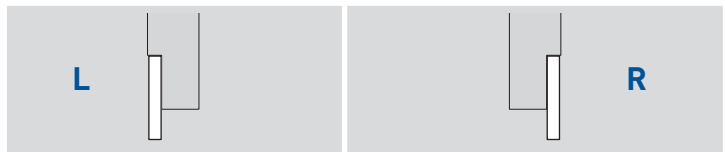
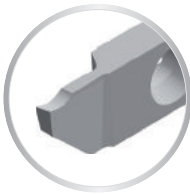
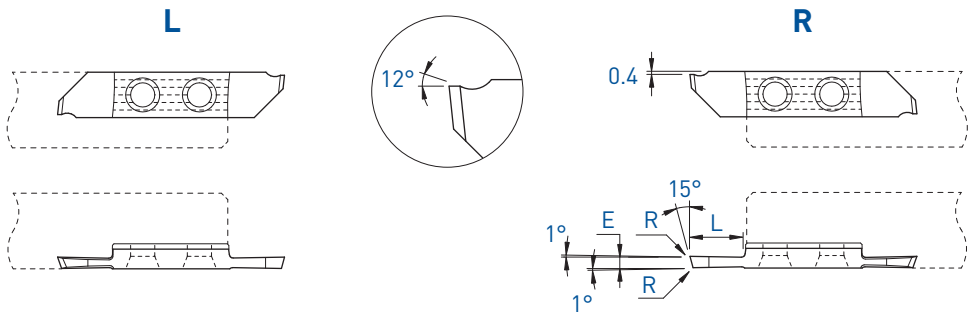

E	L	R	Art. N°	TiAlN	TiN	N (µk20)	HTA	HTiN	HN (µk10)	Art. N°	TiAlN	TiAlX	TiN	N (µk20)	HTA	HTiN	HN (µk10)
0.5	3	0.03	-							741X12-0.5					■		■
1.0	5	0.03	731X12-1.0	■	■	■				741X12-1.0	■	■	■	■	■	□	■
1.5	7	0.03	731X12-1.5	■	■	■				741X12-1.5	■	■	■	■	■	■	■
2.0	7	0.03	731X12-2.0	■	■	■				741X12-2.0	■	■	■	■	■	□	■

7XX-XX-B



Sur demande pour serrage type B, voir page 1.03
Wahlweise mit B-Spannsystem, siehe Seite 1.03
On request for B clamping system, see page 1.03

■ = disponible / verfügbar / available

□ = selon disponibilité du stock / jenach Lagerverfügbarkeit / depending on stock availability

Tronçonnage
Abstechen
Parting off

731X25 / 741X25

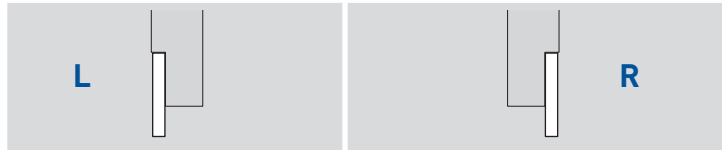
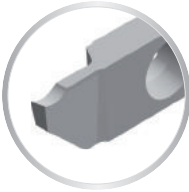
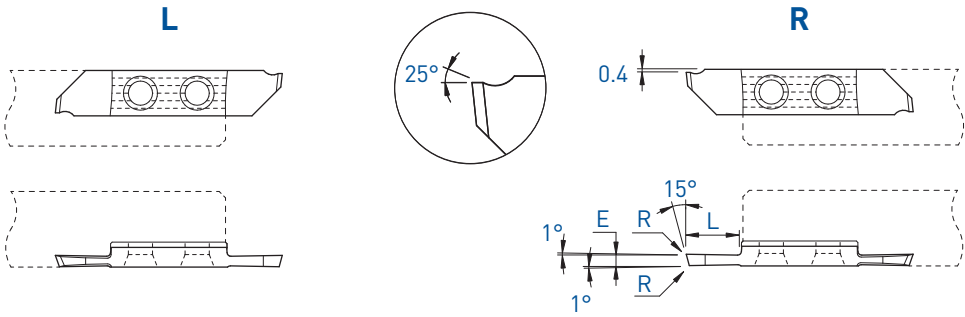

E	L	Art. N°	TiAlN	TiN	N (µk20)	HTA	HTiN	HN (µk10)	Art. N°	TiAlN	TiAlX	TiN	N (µk20)	HTA	HTiN	HN (µk10)
1.0	5	731X25-1.0	■	■	■				741X25-1.0	■		■	■	■	□	■
1.5	7	731X25-1.5	■	■	■				741X25-1.5	■		■	■	■	□	■
2.0	7	731X25-2.0	■	■	■				741X25-2.0	■	■	■	■	■	□	■

7XX-XX-B

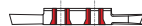

Sur demande pour serrage type B, voir page 1.03
Wahlweise mit B-Spannsystem, siehe Seite 1.03
On request for B clamping system, see page 1.03

Tronçonnage

Abstechen

Parting off

731U / 741U

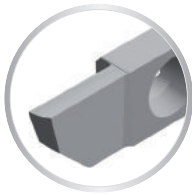
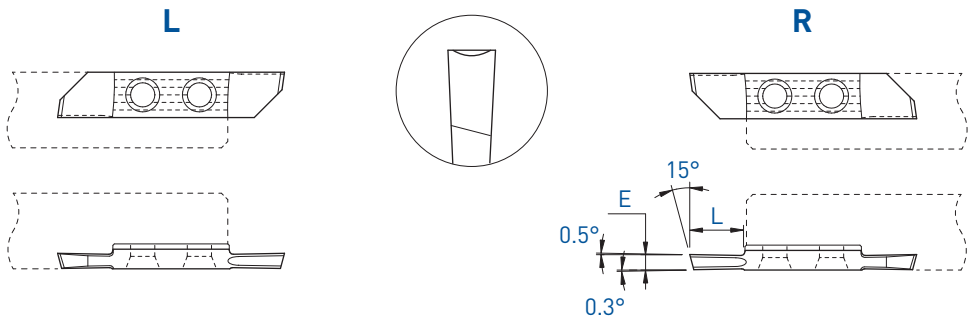

E	L	Art. N°	L			R									
			TiAlN	TiN	N (µk20)	HTA	HTiN	HN (µk10)	TiAlN	TiN	N (µk20)	HTA	HTiN	HN (µk10)	
1.5	7	731U-1.5	■	■	■	■	□	■	741U-1.5	■	■	■	■	■	■
2.0	7	731U-2.0	■	■	■	■	□	■	741U-2.0	■	■	■	■	□	■

7XX-XX-B



Sur demande pour serrage type B, voir page 1.03
Wahlweise mit B-Spannsystem, siehe Seite 1.03
On request for B clamping system, see page 1.03

■ = disponible / verfügbar / available

□ = selon disponibilité du stock / jenach Lagerverfügbarkeit / depending on stock availability

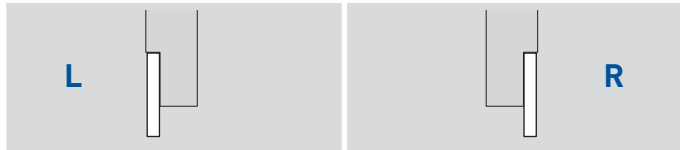
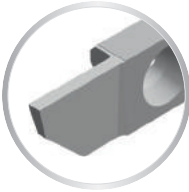
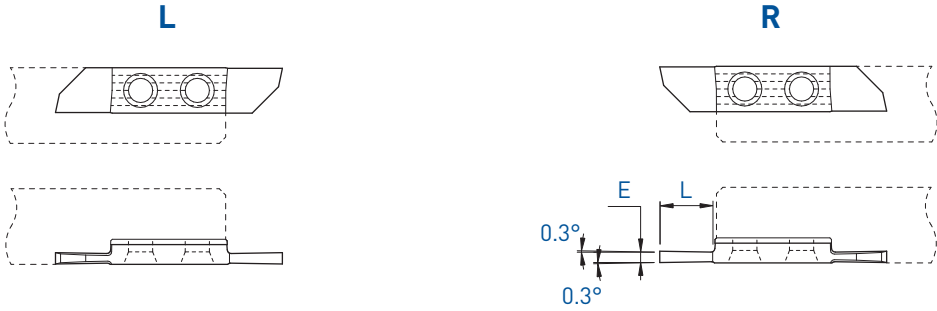

E	L	Art. N°	TiAlN	TiN	N (µk20)	HTA	HTiN	HN (µk10)	Art. N°	TiAlN	TiN	N (µk20)	HTA	HTiN	HN (µk10)
1.0	5	731N-1.0	■	■	■	■	□	■	741N-1.0	■	■	■	■	□	■
1.5	7	731N-1.5	■	■	■	■	□	■	741N-1.5	■	■	■	■	□	■

7XX-XX-B



Sur demande pour serrage type B, voir page 1.03
Wahlweise mit B-Spannsystem, siehe Seite 1.03
On request for B clamping system, see page 1.03

Tronçonnage
Abstechen
Parting off

Coupe déportée
Versetztes Schneiden
Cut off line

741L / 731R

Cut L

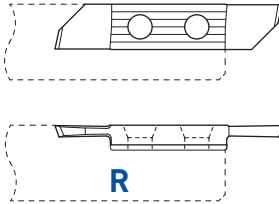

Cut R

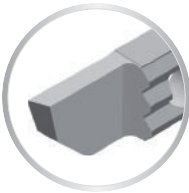
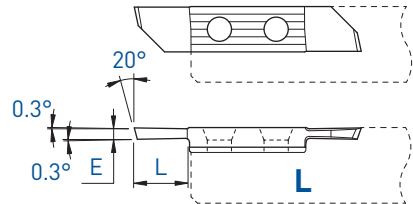

R (L)

Coupe à gauche déportée
Versetztes Linksschneiden
Left cut off line

L (R)

Coupe à droite déportée
Versetztes Rechtsschneiden
Right cut off line

E	L	Art. N°	TiAlN	TiN	N (µk20)	HTA	HTiN	HN (µk10)	Art. N°	TiAlN	TiN	N (µk20)	HTA	HTiN	HN (µk10)
1.0	5	741L-1.0	■	■	■	■	□	■	731R-1.0	■	■	■	■	■	■
1.2	5	741L-1.2	■	■	■	■	□	■	731R-1.2	■	■	■	■	□	■
1.5	7	741L-1.5	■	■	■	■	■	■	731R-1.5	■	■	■	■	■	■
2.0	7	741L-2.0	■	■	■	■	□	■	731R-2.0	■	■	■	■	□	■
2.5	7	741L-2.5	■	■	■				731R-2.5	■	■	■			

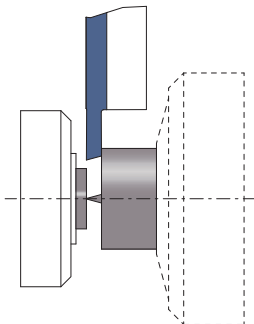

Tronçonnage
Abstechen
Parting off

Coupe déportée
Versetztes Schneiden
Cut off line

741LX4 / 731RX4

Cut L

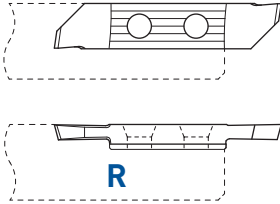

Cut R

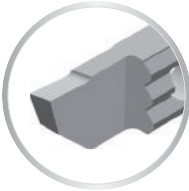
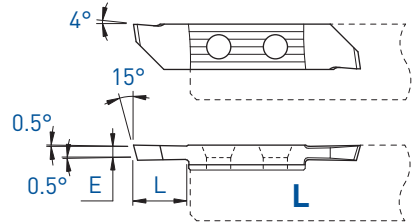

R (L)

Coupe à gauche déportée
Versetztes Linksschneiden
Left cut off line

L (R)

Coupe à droite déportée
Versetztes Rechtsschneiden
Right cut off line

E	L	Art. N°	TiAlN	TiN	N (µk20)	HTA	HTiN	HN (µk10)	Art. N°	TiAlN	TiN	N (µk20)	HTA	HTiN	HN (µk10)
1.5	5	741LX4-1.5	■	■	■				731RX4-1.5	■	■	■	■	■	■

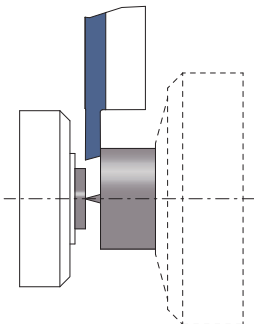

Tronçonnage
Abstechen
Parting off

Coupe déportée
Versetztes Schneiden
Cut off line

741LXF / 731RXF

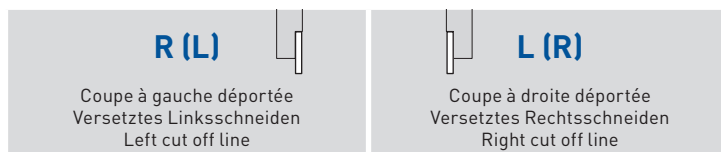
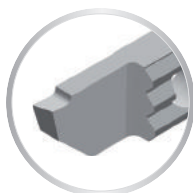
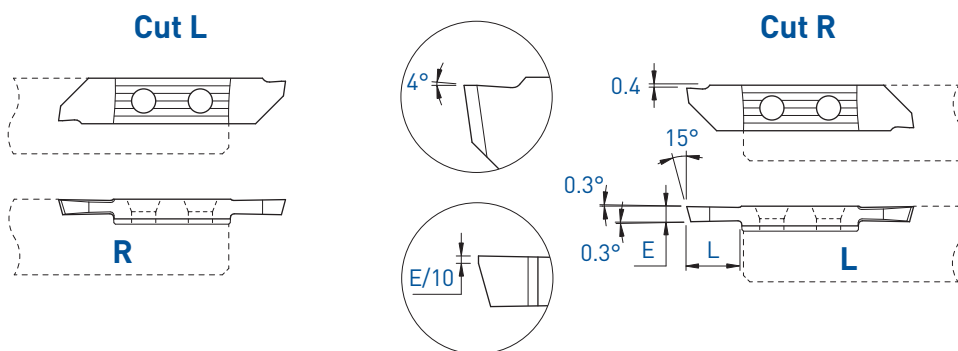

E	L	Art. N°	R (L)			L (R)		
			TiAlN	TiN	N (µk20)	TiAlN	TiN	N (µk20)
1.5	7	741LXF-1.5	■	■	■	■	■	■
2.0	7	741LXF-2.0	■	■	■	■	■	□
2.5	7	741LXF-2.5	■	■	■	■	■	■

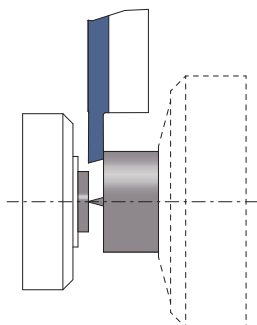

Tronçonnage
Abstechen
Parting off

Coupe déportée
Versetztes Schneiden
Cut off line

741LX12 / 731RX12

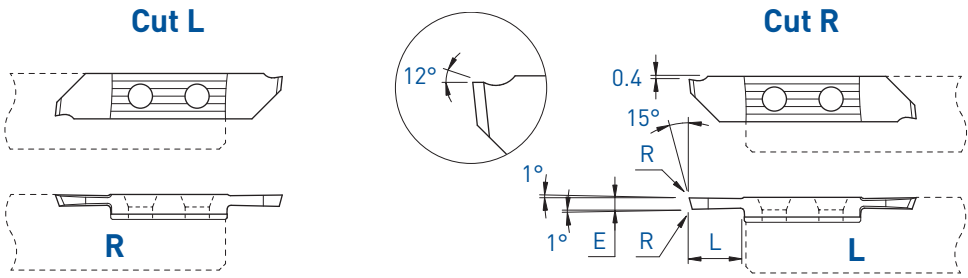

R (L)

Coupe à gauche déportée
Versetztes Linksschneiden
Left cut off line

L (R)

Coupe à droite déportée
Versetztes Rechtsschneiden
Right cut off line

E	L	R	Art. N°	TiAlN	TiN	N (µk20)	HTA	HTiN	HN (µk10)	Art. N°	TiAlN	TiN	N (µk20)	HTA	HTiN	HN (µk10)
1.0	5	0.03	-							731RX12-1.0	■	□	■			
1.5	7	0.03	741LX12-1.5	■	■	■				731RX12-1.5	■	■	■	■	■	■

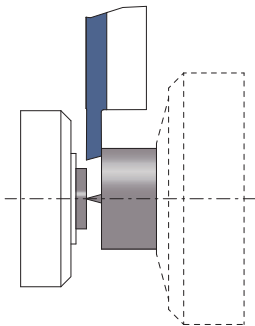

Tronçonnage
Abstechen
Parting off

Coupe déportée
Versetztes Schneiden
Cut off line

741LX25 / 731RX25

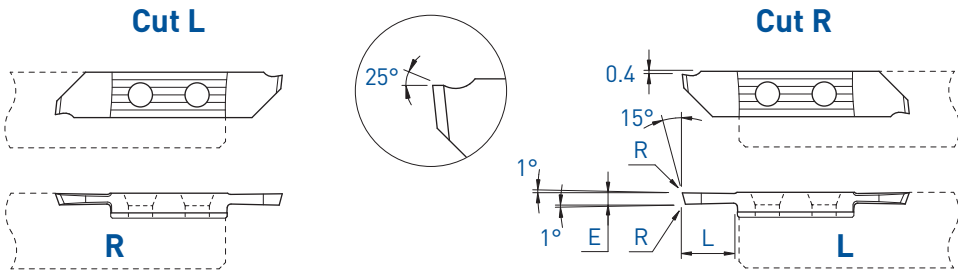

R (L)	L (R)
Coupe à gauche déportée Versetztes Linksschneiden Left cut off line	Coupe à droite déportée Versetztes Rechtsschneiden Right cut off line

E	L	R	Art. N°	TiAlN	TiN	N (µk20)	Art. N°	TiAlN	TiN	N (µk20)
1.5	7	0.03	741LX25-1.5	■	■	■	731RX25-1.5	■	■	■

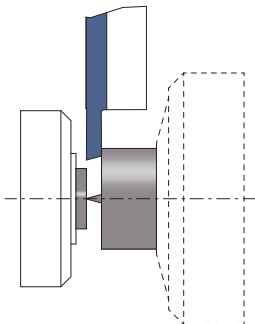

■ = disponible / verfügbar / available
□ = selon disponibilité du stock / jenach Lagerverfügbarkeit / depending on stock availability

Tronçonnage
 Abstechen
 Parting off

Coupe déportée
 Versetztes Schneiden
 Cut off line

731RU

Cut R

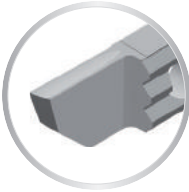
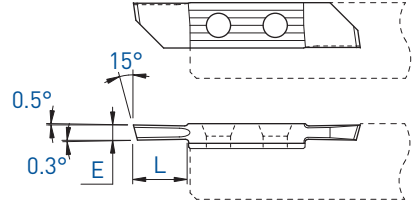
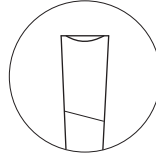

L (R)
 Coupe à droite déportée
 Versetztes Rechtsschneiden
 Right cut off line

E	L	Art. N°	TiAlN	TiN	N (µk20)	HTA	HTiN	HN (µk10)
1.0	5	731RU-1.0	■	□	■			
1.2	5	731RU-1.2	■	□	■			
1.5	7	731RU-1.5	■	□	■	■	□	■
2.0	7	731RU-2.0	■	□	■			

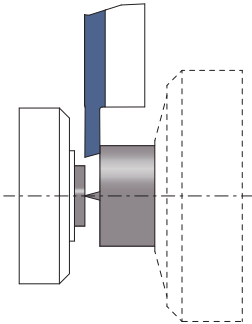

Tronçonnage
Abstechen
Parting off

Coupe déportée
Versetztes Schneiden
Cut off line

741N / 731N

Cut L

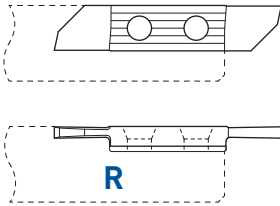

Cut R

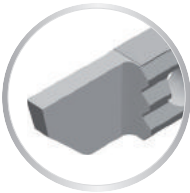
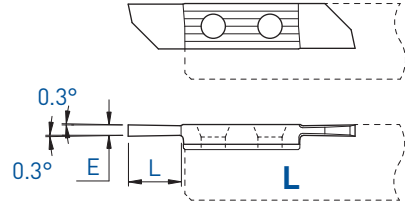

R (L)

Coupe à gauche déportée
Versetztes Linksschneiden
Left cut off line

L (R)

Coupe à droite déportée
Versetztes Rechtsschneiden
Right cut off line

E	L	Art. N°	TiAlN	TiN	N (µk20)	HTA	HTiN	HN (µk10)	Art. N°	TiAlN	TiN	N (µk20)	HTA	HTiN	HN (µk10)
1.0	5	741N-1.0	■	■	■	■	□	■	731N-1.0	■	■	■	■	□	■
1.5	7	741N-1.5	■	■	■	■	□	■	731N-1.5	■	■	■	■	□	■

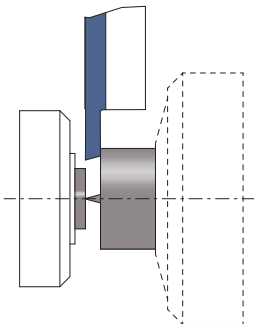

TOP-LINE

Tournage avant
Vorwärts drehen
Front turning

732 / 742

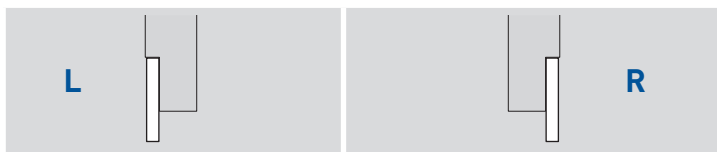
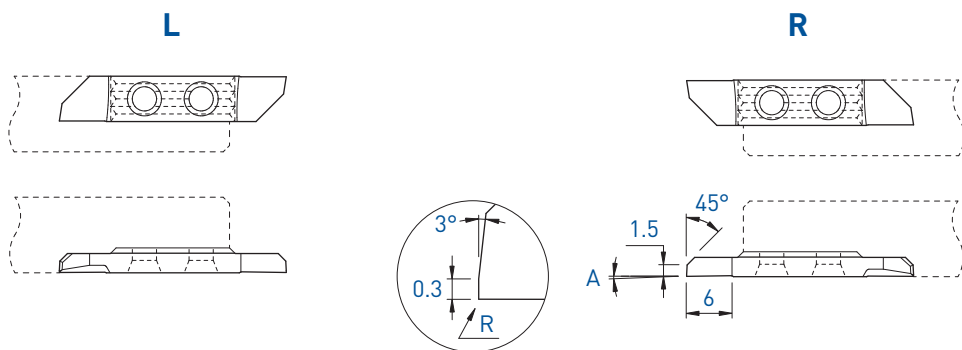

A	R	Art. N°	TiAlN	TiN	N (µk20)	HTA	HTiN	HN (µk10)	Art. N°	TiAlN	TiAlX	TiN	N (µk20)	HTA	HTiN	HN (µk10)
0°	0	732	■	■	■	■	■	■	742	■	■	■	■	■	■	■
2°	0	732-2°	■	■	■	■	□	■	742-2°	■	■	■	■	■	■	■

7XX-XX-B



Sur demande pour serrage type B, voir page 1.03
Wahlweise mit B-Spannsystem, siehe Seite 1.03
On request for B clamping system, see page 1.03

Tournage avant
Vorwärts drehen
Front turning

732PX / 742PX

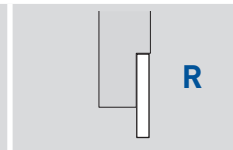
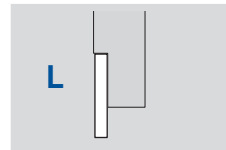
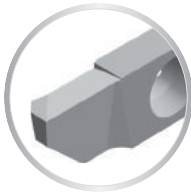
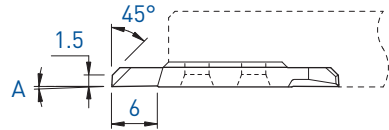
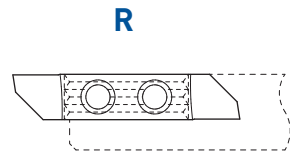
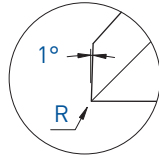
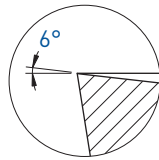
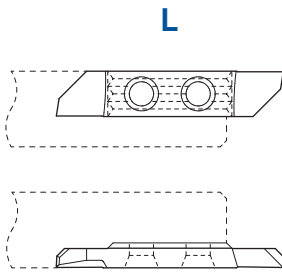

A	R	L			R				
		Art. N°	TiAlN	TiN	N [µk20]	Art. N°	TiAlN	TiN	N [µk20]
0°	0	732PX	■	■	■	742PX	■	■	■

7XX-XX-B



Sur demande pour serrage type B, voir page 1.03
Wahlweise mit B-Spannsystem, siehe Seite 1.03
On request for B clamping system, see page 1.03

■ = disponible / verfügbar / available
□ = selon disponibilité du stock / jenach Lagerverfügbarkeit / depending on stock availability

TOP-LINE

Tournage avant
Vorwärts drehen
Front turning

732X / 742X

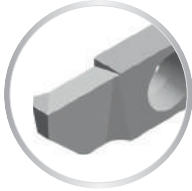
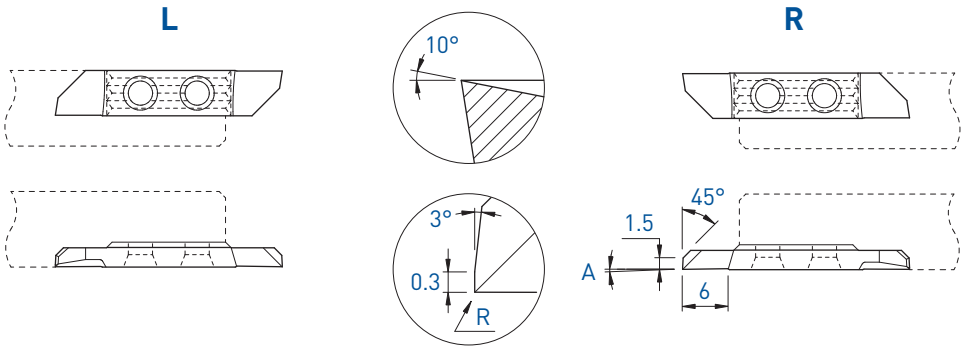

A	R	Art. N°	TiAlN	TiN	N (µk20)	HTA	HTiN	HN (µk10)	Art. N°	TiAlN	TiAlX	TiN	N (µk20)	HTA	HTiN	HN (µk10)
0°	0	732X	■	■	■	■	■	■	742X	■	■	■	■	■	■	■

7XX-XX-B Sur demande pour serrage type B, voir page 1.03
Wahlweise mit B-Spannsystem, siehe Seite 1.03
On request for B clamping system, see page 1.03



Tournage arrière
Rückwärts drehen
Back turning

733 / 743

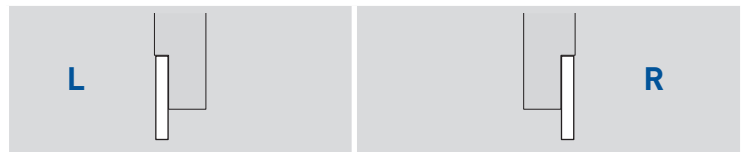
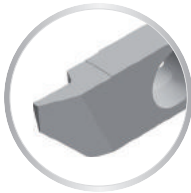
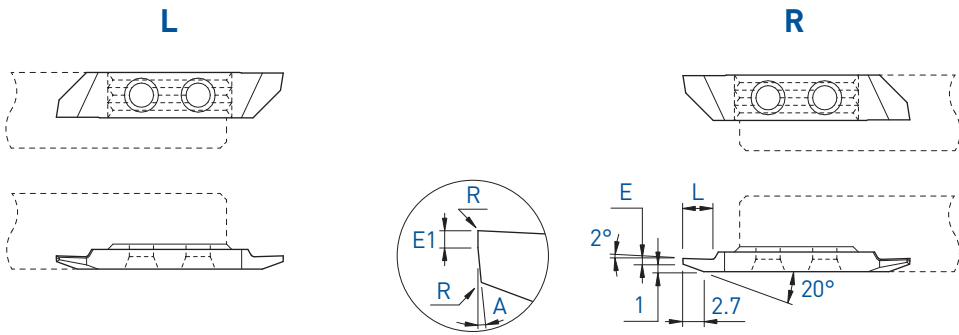

E	E1	A	L	R	Art. N°	TiAlN	TiN	N (µk20)	HTA	HTiN	HN (µk10)	Art. N°	TiAlN	TiAlX	TiN	N (µk20)	HTA	HTiN	HN (µk10)	
0.5	0.25	3°	3	0	733-0.5	■	■	■	■	□	■	743-0.5	■	■	■	■	■	■	■	■
0.5	-	2°	3	0.08	733-0.5-R08	■	■	■	■	□	■	743-0.5-R08	■	■	■	■	■	□	■	■
0.8	0.30	3°	4	0	733-0.8	■	■	■	■	□	■	743-0.8	■	■	■	■	■	□	■	■
1.0	0.40	3°	4	0	733-1.0	■	■	■	■	□	■	743-1.0	■	■	■	■	■	□	■	■
1.2	0.50	3°	5	0	733-1.2	■	■	■	■	□	■	743-1.2	■	■	■	■	■	□	■	■
1.5	0.50	3°	6	0	733-1.5	■	■	■	■	□	■	743-1.5	■	■	■	■	■	□	■	■

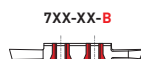

7XX-XX-B Sur demande pour serrage type B, voir page 1.03
Wahlweise mit B-Spannsystem, siehe Seite 1.03
On request for B clamping system, see page 1.03

■ = disponible / verfügbar / available
□ = selon disponibilité du stock / jenach Lagerverfügbarkeit / depending on stock availability

TOP-LINE

Tournage arrière
Rückwärts drehen
Back turning

733X / 743X

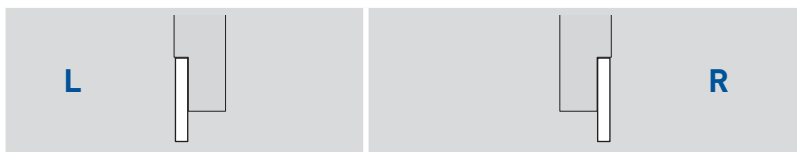
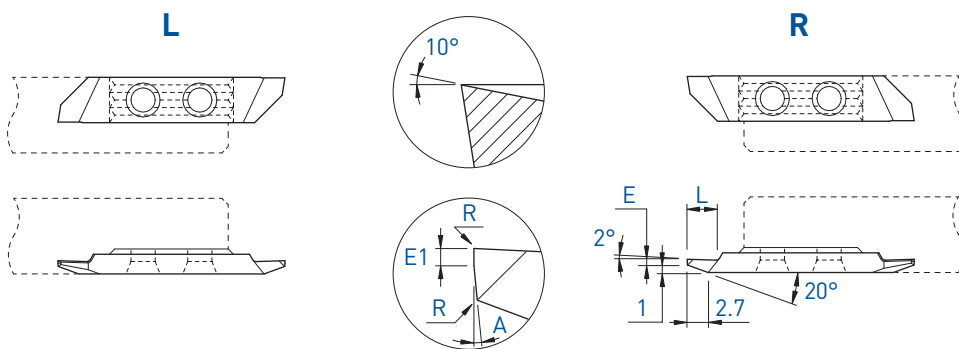

E	E1	A	L	R	Art. N°	TiAlN	TiN	N (µk20)	HTA	HTiN	HN (µk10)	Art. N°	TiAlN	TiAlX	TiN	N (µk20)	HTA	HTAX <small>new</small>	HTiN	HN (µk10)
0.5	0.25	3°	3	0	733X-0.5	■	■	■	■	□	■	743X-0.5	■	■	■	■	■	□	□	■
0.5	-	2°	3	0.08	733X-0.5-R08	■	■	■				743X-0.5-R08	■	■	■	■	■	□	□	■
0.8	0.30	3°	4	0	733X-0.8	■	■	■				743X-0.8	■		■	■			□	■
1.0	0.40	3°	4	0	733X-1.0	■	■	■				743X-1.0	■		■	■			□	■
1.2	0.50	3°	5	0	733X-1.2	■	■	■				743X-1.2	■		■	■			□	■
1.5	0.50	3°	6	0	733X-1.5	■	■	■				743X-1.5	■		■	■			□	■

7XX-XX-B



Sur demande pour serrage type B, voir page 1.03
Wahlweise mit B-Spannsystem, siehe Seite 1.03
On request for B clamping system, see page 1.03

Tournage arrière
Rückwärts drehen
Back turning

733VX-8° / 743VX-8°

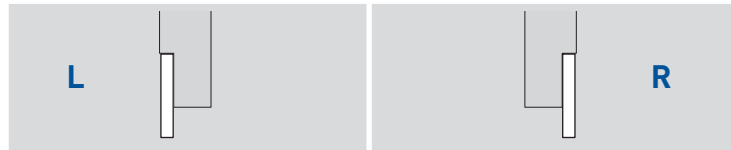
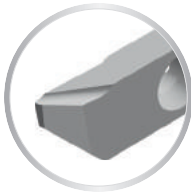
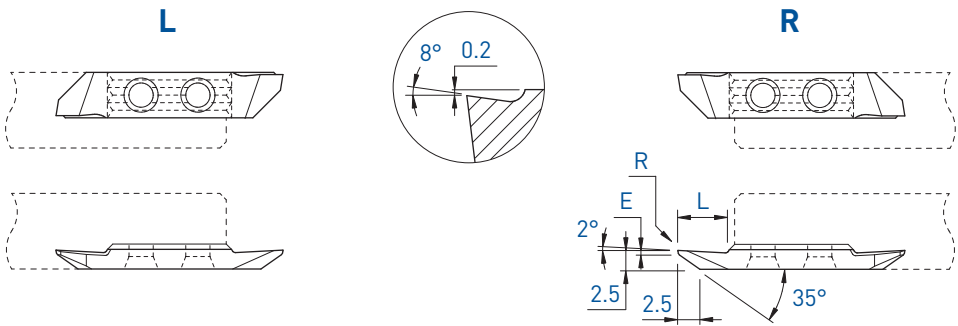

E	L	R	Art. N°	TiAlN	TiN	N (µk20)	HTA	HTiN	HN (µk10)	Art. N°	TiAlN	TiN	N (µk20)	HTA	HTiN	HN (µk10)
1.0	6.5	0	733VX-8°	■	■	■	■	■	■	743VX-8°	■	■	■	■	■	■
1.0	6.5	0.08	733VX-8°-R08	■	■	■	■	□	■	743VX-8°-R08	■	■	■	■	□	■

7XX-XX-B

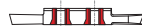

Sur demande pour serrage type B, voir page 1.03
Wahlweise mit B-Spannsystem, siehe Seite 1.03
On request for B clamping system, see page 1.03

■ = disponible / verfügbar / available
□ = selon disponibilité du stock / jenach Lagerverfügbarkeit / depending the stock availability

Tournage arrière
 Rückwärts drehen
 Back turning

733VX-805 / 743VX-805

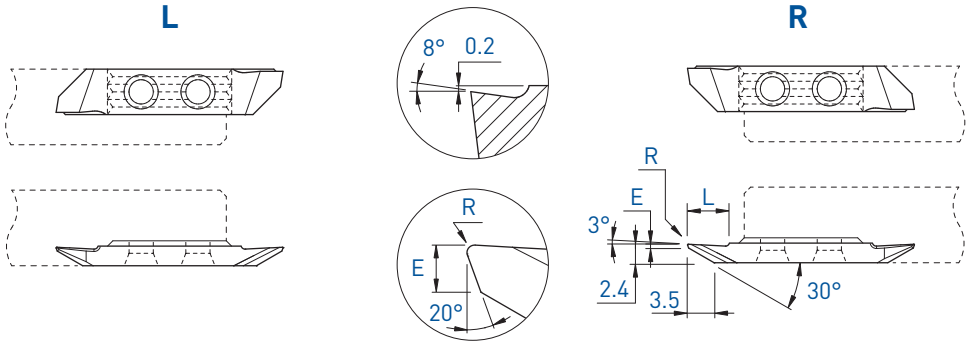

E	L	R	Art. N°	TiAlN	TiN	N (µk20)	HTA	HTiN	HN (µk10)	Art. N°	TiAlN	TiN	N (µk20)	HTA	HTiN	HN (µk10)
0.5	6	0.08	733VX-805-R08	■	□	■	■	□	■	743VX-805-R08	■	■	■	■	□	■

7XX-XX-B



Sur demande pour serrage type B, voir page 1.03
 Wahlweise mit B-Spannsystem, siehe Seite 1.03
 On request for B clamping system, see page 1.03

Tournage arrière
Rückwärts drehen
Back turning

733VX-15° / 743VX-15°

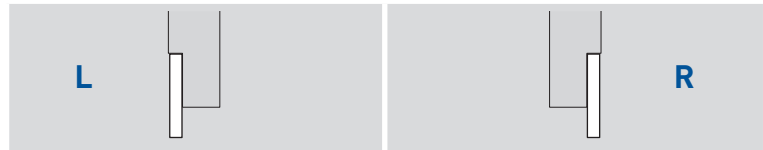
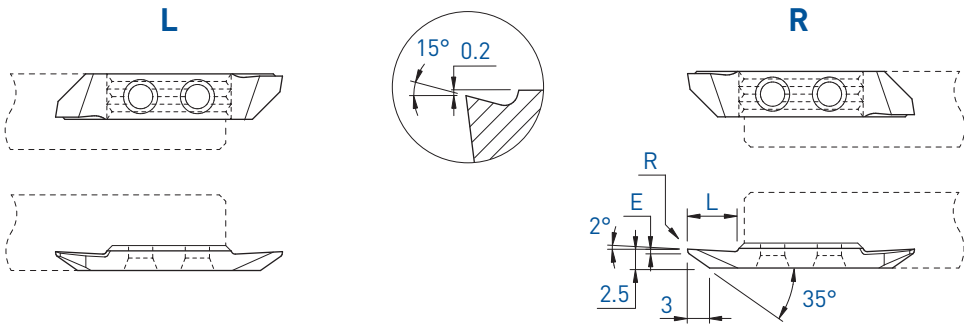

E	L	R	Art. N°	TiAlN	TiN	N (µk20)	HTA	HTiN	HN (µk10)	Art. N°	TiAlN	TiN	N (µk20)	HTA	HTiN	HN (µk10)
0.5	6.5	0	733VX-15°	■	■	■	■	□	■	743VX-15°	■	■	■	■	□	■
0.5	6.5	0.08	733VX-15°-R08	■	■	■				743VX-15°-R08	■	■	■	■	□	■

7XX-XX-B



Sur demande pour serrage type B, voir page 1.03
Wahlweise mit B-Spannsystem, siehe Seite 1.03
On request for B clamping system, see page 1.03

■ = disponible / verfügbar / available
□ = selon disponibilité du stock / jenach Lagerverfügbarkeit / depending on stock availability

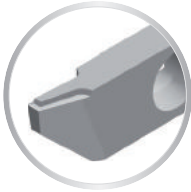
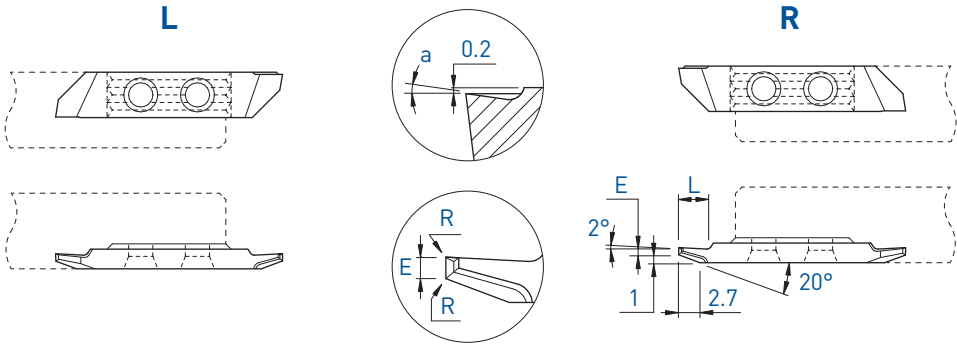

Pour un meilleur contrôle des copeaux
Für eine bessere Spankontrolle
For a better chip-control

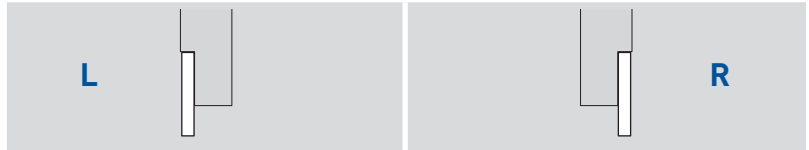

a	E	L	R	L						R						
				Art. N°	TiAlN	TiN	N (µk20)	HTA	HTiN	HN (µk10)	Art. N°	TiAlN	TiN	N (µk20)	HTA	HTiN
10°	1.0	4	0.01	733ZX10-1.0	■	□						743ZX10-1.0	■	□	■	□
	1.0	4	0.08	733ZX10-1.0-R08	■	□						743ZX10-1.0-R08	■	□	■	□



Arête de coupe honée
Gehonte Schneidkante
Honed edge

f min: 0.02 mm/U



Sur demande pour serrage type B, voir page 1.03
Wahlweise mit B-Spannsystem, siehe Seite 1.03
On request for B clamping system, see page 1.03

Tournage arrière / pré-coupe
 Rückwärts drehen / vorstechen
 Back turning / pre-parting off

733P / 743P

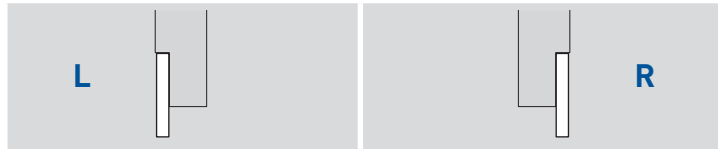
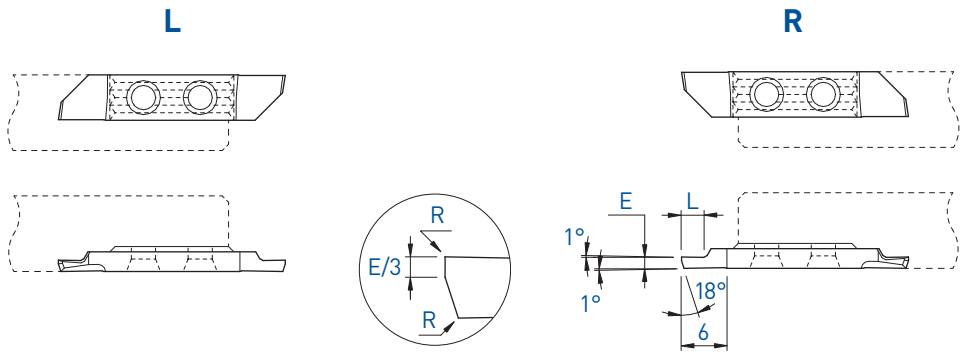

E	L	R	Art. N°	L			R									
				TiAlN	TiN	N (µk20)	HTA	HTiN	HN (µk10)	Art. N°	TiAlN	TiN	N (µk20)	HTA	HTiN	HN (µk10)
0.8	2	0	733P-0.8	■	■	■				743P-0.8	■	■	■	■	□	■
1.0	2	0	733P-1.0	■	■	■				743P-1.0	■	■	■			
1.2	2.5	0	733P-1.2	■	■	■				743P-1.2	■	■	■			
1.5	3	0	733P-1.5	■	■	■				743P-1.5	■	■	■			

7XX-XX-B



Sur demande pour serrage type B, voir page 1.03
 Wahlweise mit B-Spannsystem, siehe Seite 1.03
 On request for B clamping system, see page 1.03

■ = disponible / verfügbar / available
 □ = selon disponibilité du stock / jenach Lagerverfügbarkeit / depending on stock availability

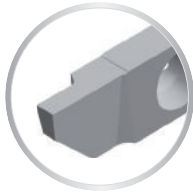
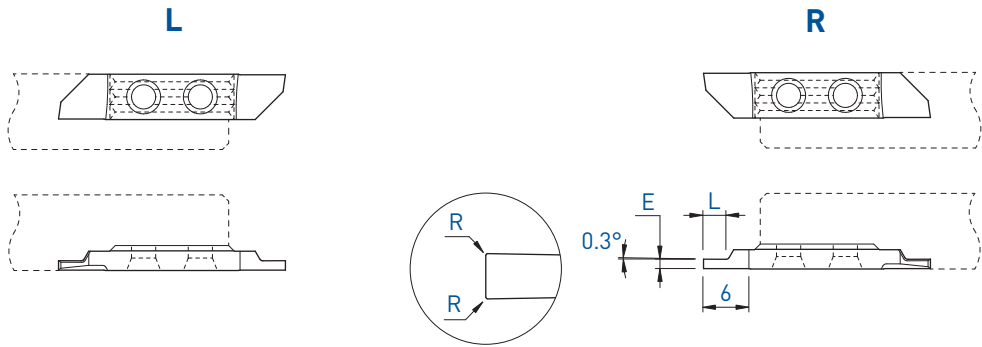

E	L	R	Art. N°	TiAlN	TiN	N (µk20)	HTA	HTiN	HN (µk10)	Art. N°	TiAlN	TiAlX	TiN	N (µk20)	HTA	HTAX	HTiN	HN (µk10)
0.5	1.5	0	734-0.5	■	■	■	■	□	■	744-0.5	■	■	■	■	■	■	■	■
0.6	1.8	0	734-0.6	■	■	■	■	□	■	744-0.6	■	■	■	■	■	■	□	■
0.75	2	0	734-0.75	■	■	■	■	■	■	744-0.75	■	■	■	■	■	■	■	■
0.8	2	0	734-0.8	■	■	■	■	□	■	744-0.8	■	■	■	■	■	■	□	■
0.8	2	0.08	-							744-0.8-R08	■	■	■	■	■	■	□	■
0.9	2.5	0	-							744-0.9	■	■	■	■	■	■	□	■
0.95	3	0	734-0.95	■	■	■	■	■	■	744-0.95	■	■	■	■	■	■	□	■
1.0	2.5	0	734-1.0	■	■	■	■	■	■	744-1.0	■	■	■	■	■	■	■	■
1.0	2.5	0.08	734-1.0-R08	■	■	■	■	■	■	744-1.0-R08	■	■	■	■	■	■	□	■
1.2	3	0	734-1.2	■	■	■	■	□	■	744-1.2	■	■	■	■	■	■	■	■
1.5	3	0	734-1.5	■	■	■	■	■	■	744-1.5	■	■	■	■	■	■	■	■
1.5	3	0.08	734-1.5-R08	■	■	■	■	□	■	744-1.5-R08	■	■	■	■	■	■	□	■
1.5	3	0.15	-							744-1.5-R15	■	■	□	■	■	■	□	■
1.5	3	0.20	-							744-1.5-R20	■	■	■	■	■	■	□	■
1.8	4	0	734-1.8	■	■	■	■	□	■	744-1.8	■	■	■	■	■	■	□	■
2.0	4	0	734-2.0	■	■	■	■	□	■	744-2.0	■	■	■	■	■	■	□	■
2.0	4	0.08	734-2.0-R08	■	■	■	■	□	■	744-2.0-R08	■	■	■	■	■	■	□	■
2.0	4	0.15	-							744-2.0-R15	■	■	□	■	■	■	□	■
2.0	4	0.20	-							744-2.0-R20	■	■	■	■	■	■	□	■
2.5	6	0	734-2.5	■	■	■	■	■	■	744-2.5	■	■	■	■	■	■	□	■

7XX-XX-B



Sur demande pour serrage type B, voir page 1.03
Wahlweise mit B-Spannsystem, siehe Seite 1.03
On request for B clamping system, see page 1.03

Fonçage-tournage

Einstecken und drehen

Grooving and turning

734VS / 744VS

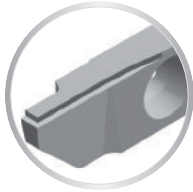
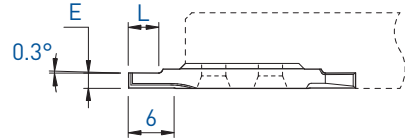
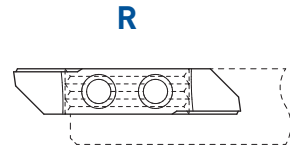
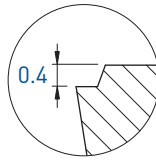
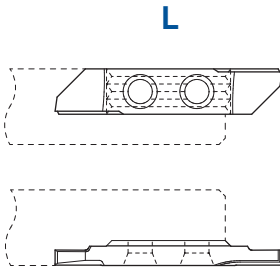

E	L	Art. N°	L			R			Art. N°	R					
			TiAlN	TiN	N (µk20)	HTA	HTiN	HN (µk10)		TiAlN	TiN	N (µk20)	HTA	HTiN	HN (µk10)
1.0	2	734VS-1.0	■	■	■	■	□	■	744VS-1.0	■	■	■	■	□	■
1.2	2.5	734VS-1.2	■	■	■	■	□	■	744VS-1.2	■	■	■	■	□	■
1.5	3	734VS-1.5	■	■	■	■	□	■	744VS-1.5	■	■	■	■	□	■
1.8	4	734VS-1.8	■	■	■				744VS-1.8	■	■	■			
2.0	4	734VS-2.0	■	■	■				744VS-2.0	■	■	■	■	□	■
2.5	6	734VS-2.5	■	■	■				744VS-2.5	■	■	■			

7XX-XX-B

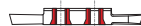

Sur demande pour serrage type B, voir page 1.03
Wahlweise mit B-Spannsystem, siehe Seite 1.03
On request for B clamping system, see page 1.03

■ = disponible / verfügbar / available
□ = selon disponibilité du stock / jenach Lagerverfügbarkeit / depending on stock availability

TOP-LINE

Fonçage-tournage
Einstecken und drehen
Grooving and turning

734X / 744X

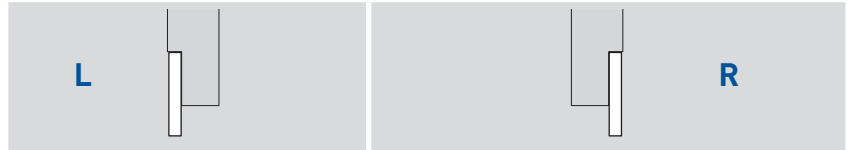
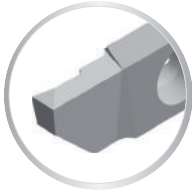
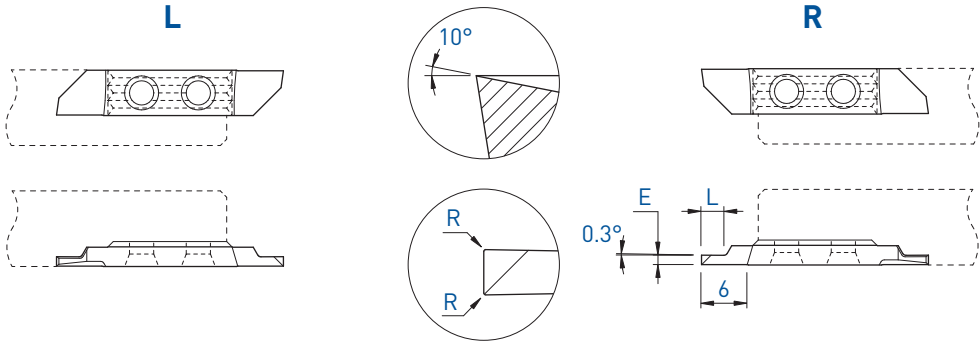

E	L	R	Art. N°	TiAlN			HTA			Art. N°	TiAlN			HTA				
				TiN	N (µk20)	HN (µk10)	HTA	HTIN	HN (µk10)		TiAlN	TiAlX	LoX	TiN	N (µk20)	HTA	HTAX	HTIN
0.8	2	0	734X-0.8	■	■	■	■	□	■	744X-0.8	■	■	■	■	■	■	■	■
1.0	2.5	0	734X-1.0	■	■	■	■	□	■	744X-1.0	■	■	■	■	■	■	■	■
1.0	2.5	0.08	734X-1.0-R08	■	■	■	■	□	■	744X-1.0-R08	■	■	■	■	■	■	□	■
1.2	3	0	734X-1.2	■	■	■	■	□	■	744X-1.2	■	■	■	■	■	■	□	■
1.5	3	0	734X-1.5	■	■	■	■	■	■	744X-1.5	■	■	■	■	■	■	■	■
1.5	3	0.08	734X-1.5-R08	■	■	■	■	□	■	744X-1.5-R08	■	■	■	■	■	■	□	■
1.5	3	0.15	-							744X-1.5-R15	■	■	□	■	■	■	□	■
1.5	3	0.20	-							744X-1.5-R20	■	■	■	■	■	■	□	■
1.8	4	0	734X-1.8	■	■	■				744X-1.8	■	■	■	■	■	■	□	■
2.0	4	0	734X-2.0	■	■	■	■	□	■	744X-2.0	■	■	■	■	■	■	■	■
2.0	4	0.08	734X-2.0-R08	■	■	■	■	□	■	744X-2.0-R08	■	■	■	■	■	■	■	■
2.0	4	0.15	-							744X-2.0-R15	■	■	□	■	■	■	□	■
2.0	4	0.20	734X-2.0-R20	■	■	■	■	□	■	744X-2.0-R20	■	■	■	■	■	■	□	■
2.5	6	0	734X-2.5	■	■	■	■	□	■	744X-2.5	■	■	■	■	■	■	□	■

7XX-XX-B

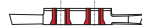

Sur demande pour serrage type B, voir page 1.03
Wahlweise mit B-Spannsystem, siehe Seite 1.03
On request for B clamping system, see page 1.03

Fonçage-tournage

Einstecken und drehen

Grooving and turning

734ZX / 744ZX

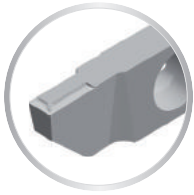
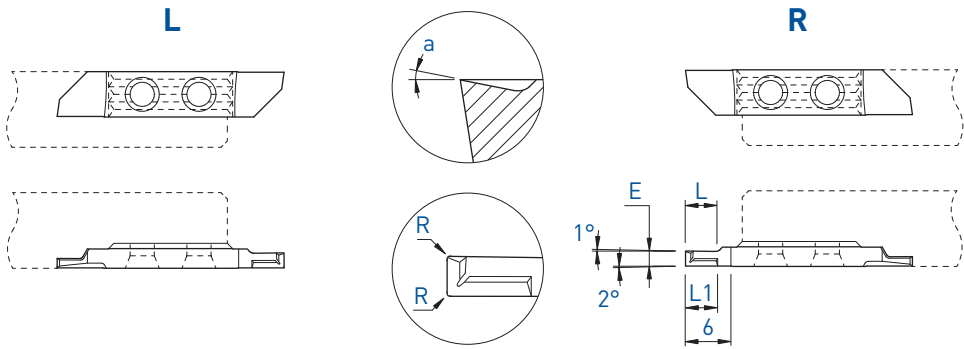

Pour un meilleur contrôle des copeaux
Für eine bessere Spankontrolle
For a better chip-control



a	E	L	L1	R	Art. N°	TiAlN				Art. N°								
						TiN	TiN	N (µk20)	HTA	HAS	HTiN	HN (µk10)	TiAlN	TiAlX	TiN	N (µk20)	HTA	HAS
10°	1.0	2.5	3	0.01	734ZX10-1.0	■	■					744ZX10-1.0	■	■	■	■		□
	1.5	4	4	0.01	734ZX10-1.5	■	■					744ZX10-1.5	■	■	□	■		■
	1.5	4	4	0.08	734ZX10-1.5-R08	■	■					744ZX10-1.5-R08	■	■	■	■		
	2.0	4	4	0.01	734ZX10-2.0	■	■					744ZX10-2.0	■	■	□	■		□
	2.0	4	4	0.08	734ZX10-2.0-R08	■	■					744ZX10-2.0-R08	■	■	□	■		
	2.5	6	4	0.01	734ZX10-2.5	■	■					744ZX10-2.5	■	■	□	■		□
	2.5	6	4	0.08	-							744ZX10-2.5-R08	■	■	□	■		
17°	1.0	2.5	3	0.01	-							744ZX17-1.0				■	■	

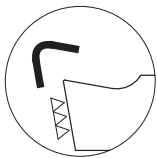

Arête de coupe honée
Gehonte Schneidkante
Honed edge

f min: 0.02 mm/U



7XX-XX-B

Sur demande pour serrage type B, voir page 1.03
Wahlweise mit B-Spannsystem, siehe Seite 1.03
On request for B clamping system, see page 1.03

■ = disponible / verfügbar / available
□ = selon disponibilité du stock / jenach Lagerverfügbarkeit / depending on stock availability

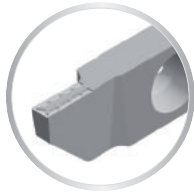
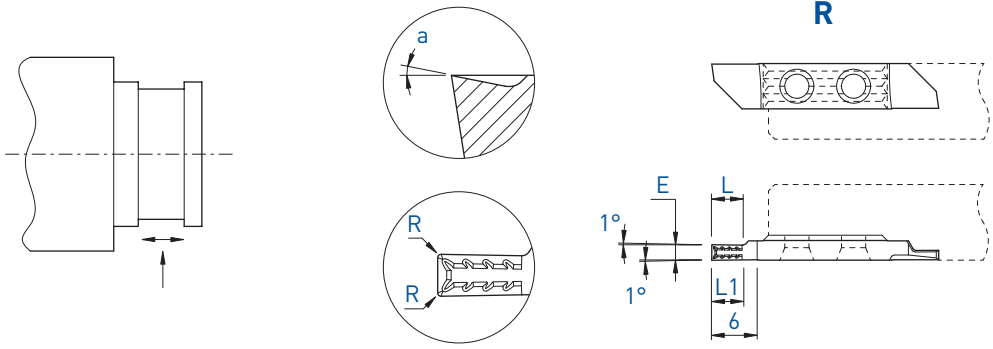

Pour un meilleur contrôle des copeaux
Für eine bessere Spankontrolle
For a better chip-control

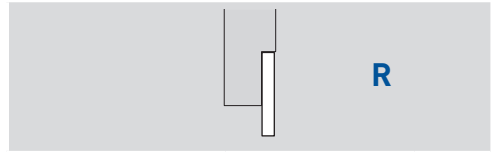

a	E	L	L1	R	Art. N°	TiAIN	TiAlX	LOX	TiN	N (µk20)	HTA	HTiN	HN (µk10)
10°	1.0	2.5	2.5	0.01	744ZXT10-1.0	■	■	■	■		■	□	
	1.5	4	4	0.01	744ZXT10-1.5	■	■	■	□		■	□	
	1.5	4	4	0.08	744ZXT10-1.5-R08	■	■	■	■		■	□	
	2.0	4	4	0.01	744ZXT10-2.0	■	■	■	□		■	□	
	2.0	4	4	0.08	744ZXT10-2.0-R08	■	■	■	□		■	□	
	2.5	5	5	0.01	744ZXT10-2.5	■	■	■	□		■	□	
	2.5	5	5	0.08	744ZXT10-2.5-R08	■	■	■	□		■	□	

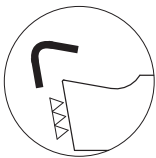

Arête de coupe honée
Gehonte Schneidkante
Honed edge

f min: 0.02 mm/U



7XX-XX-B
Sur demande pour serrage type B, voir page 1.03
Wahlweise mit B-Spannsystem, siehe Seite 1.03
On request for B clamping system, see page 1.03

Gorges
Einstechen
Grooving

735 / 745

L

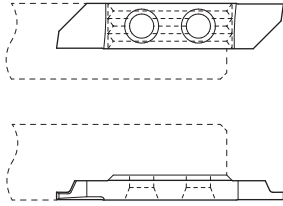

R

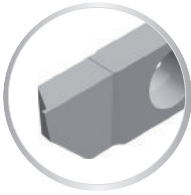
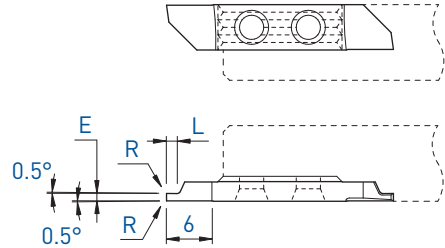

L



R



E ± 0.01			Art. N°	TiAlN			HN (µk10)			Art. N°	TiAlN			HN (µk10)		
	L	R		TiN	N (µk20)	HTA	HTiN	HTA	HTiN		TiN	N (µk20)	HTA	HTiN	HN	
0.2	0.2	0	735-0202	■	■	■			745-0202	■	■	■	■	□	■	
0.3	0.3	0	735-0303	■	■	■			745-0303	■	■	■	■	□	■	
0.4	0.4	0	735-0404	■	■	■			745-0404	■	□	■	■	□	■	

7XX-XX-B



Sur demande pour serrage type B, voir page 1.03
Wahlweise mit B-Spannsystem, siehe Seite 1.03
On request for B clamping system, see page 1.03

■ = disponible / verfügbar / available
□ = selon disponibilité du stock / jenach Lagerverfügbarkeit / depending on stock availability

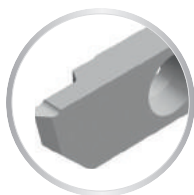
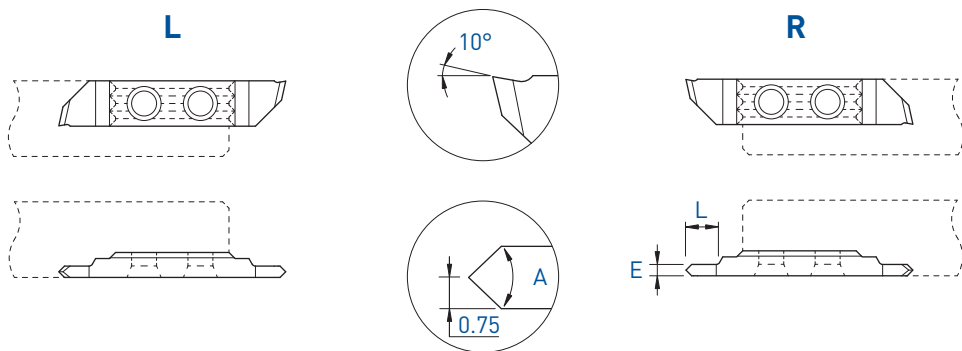

A	E	L	Art. N°	TiAlN	TiN	N (μk20)	Art. N°	TiAlN	TiN	N (μk20)
90°	1.5	4	735X-90-1.5	□	□	□	745X-90-1.5	■	□	■

7XX-XX-B



Sur demande pour serrage type B, voir page 1.03
Wahlweise mit B-Spannsystem, siehe Seite 1.03
On request for B clamping system, see page 1.03

Filetage

Gewinde drehen

Threading

736 / 746

L

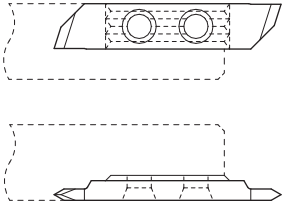

R

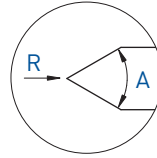
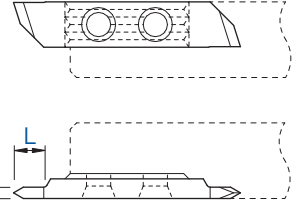

Profil partiel
Teilprofil
Partial profile

L



R



A	E	L	R	Art. N°	TiAlN	TiN	N (µk20)	HTA	HTiN	HN (µk10)	Art. N°	TiAlN	TiN	N (µk20)	HTA	HTiN	HN (µk10)
60°	1.5	4	0	736-60-1.5	■	■	■				746-60-1.5	■	■	■			
60°	1.5	4	0.02	736-60-1.5-R02	■	■	■				746-60-1.5-R02	■	■	■		□	■
60°	2.0	6	0	736-60-2.0	■	■	■				746-60-2.0	■	■	■			
60°	2.0	6	0.02	736-60-2.0-R02	■	■	■				746-60-2.0-R02	■	■	■			
55°	1.5	4	0	736-55-1.5	■	■	■				746-55-1.5	■	■	■			
55°	1.5	4	0.02	736-55-1.5-R02	■	■	■				746-55-1.5-R02	■	■	■			
55°	2.0	6	0	736-55-2.0	■	■	■				746-55-2.0	■	■	■			
55°	2.0	6	0.02	736-55-2.0-R02	■	■	■				746-55-2.0-R02	■	■	■			

7XX-XX-B



Sur demande pour serrage type B, voir page 1.03
Wahlweise mit B-Spannsystem, siehe Seite 1.03
On request for B clamping system, see page 1.03

■ = disponible / verfügbar / available
□ = selon disponibilité du stock / jenach Lagerverfügbarkeit / depending on stock availability

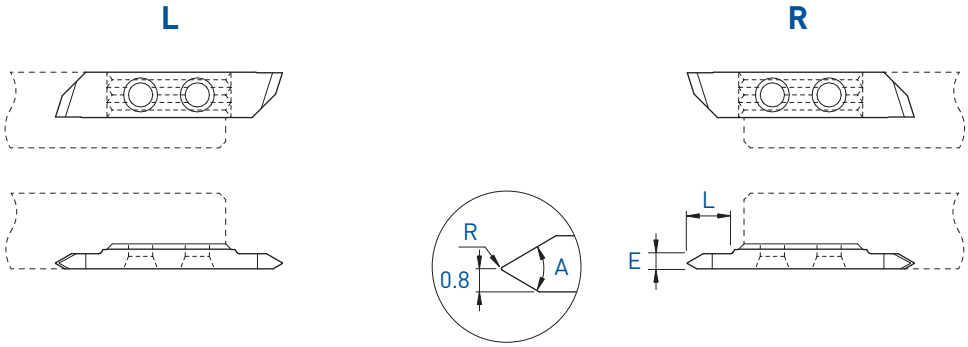

Profil partiel
Teilprofil
Partial profile



A	E	L	R	Pas Steigung Pitch P	Art. N°	TiAlN	TiN	N (µk20)	HTA	HTiN	HN (µk10)	Art. N°	TiAlN	TiN	N (µk20)	HTA	HTiN	HN (µk10)
60°	2.0	6	0.06	0.50-1.50	736-A60°	■	■	■				746-A60°	■	■	■	■	□	■

Plaquettes de filetage avec coupe positive 2°, voir page 1.126
WSP Gewindedrehen mit positivem Schnitt 2°, siehe Seite 1.126
Threading inserts with positive cut 2°, see page 1.126

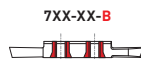

Sur demande pour serrage type B, voir page 1.03
Wahlweise mit B-Spannsystem, siehe Seite 1.03
On request for B clamping system, see page 1.03

Filetage

Gewinde drehen

Threading

736-M / 746-M

L

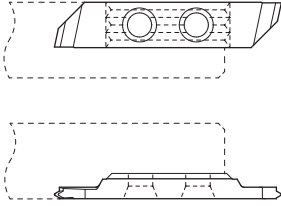

R

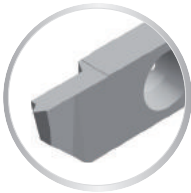
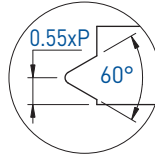
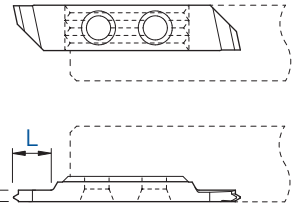

Profil complet métrique
Metrisches Vollprofil
Metric full profile

L

R

Pas Steigung Pitch P	E	L	L			R				
			Art. N°	TiAIN	TiN	N (µk20)	Art. N°	TiAIN	TiN	N (µk20)
0.25	1.0	3	736-M-0.25	■	■	■	746-M-0.25	■	■	■
0.30	1.0	3	736-M-0.30	■	■	■	746-M-0.30	■	■	■
0.35	1.0	3	736-M-0.35	■	■	■	746-M-0.35	■	■	■
0.40	1.0	3	736-M-0.40	■	■	■	746-M-0.40	■	■	■
0.45	1.0	3	736-M-0.45	■	■	■	746-M-0.45	■	■	■
0.50	1.0	3	736-M-0.50	■	■	■	746-M-0.50	■	■	■
0.60	1.0	3	736-M-0.60	■	■	■	746-M-0.60	■	■	■
0.70	1.0	3	736-M-0.70	■	■	■	746-M-0.70	■	■	■
0.75	1.0	3	736-M-0.75	■	■	■	746-M-0.75	■	■	■
0.80	1.5	4.5	736-M-0.80	■	■	■	746-M-0.80	■	■	■
1.00	1.5	4.5	736-M-1.00	■	■	■	746-M-1.00	■	■	■
1.25	1.5	4.5	736-M-1.25	■	■	■	746-M-1.25	■	■	■
1.50	2.0	6	736-M-1.50	■	■	■	746-M-1.50	■	■	■
1.75	2.0	6	736-M-1.75	■	■	■	746-M-1.75	■	■	■

Plaquettes de filetage avec coupe positive 2°, voir page 1.127
WSP Gewindedrehen mit positivem Schnitt 2°, siehe Seite 1.127
Threading inserts with positive cut 2°, see page 1.127

7XX-XX-B



Sur demande pour serrage type B, voir page 1.03
Wahlweise mit B-Spannsystem, siehe Seite 1.03
On request for B clamping system, see page 1.03

■ = disponible / verfügbar / available
□ = selon disponibilité du stock / jenach Lagerverfügbarkeit / depending on stock availability

L

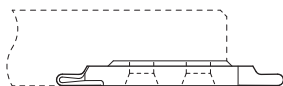
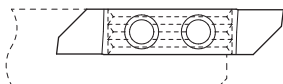

R

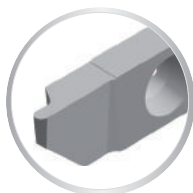
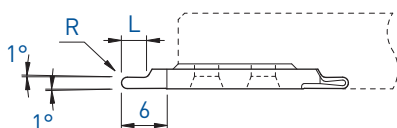
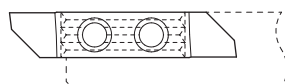

R	L	Art. N°	L			R			
			TiAlN	TiN	N (μm20)	TiAlN	TiN	N (μm20)	
0.25	1.5	-				747-R0.25	■	■	■
0.40	2	-				747-R0.4	■	■	■
0.50	2.5	737-R0.5	■	■	■	747-R0.5	■	■	■
0.60	2.5	737-R0.6	■	■	■	747-R0.6	■	■	■
0.75	3	737-R0.75	■	■	■	747-R0.75	■	■	■
0.80	3	737-R0.8	■	■	■	747-R0.8	■	■	■
1.00	4	737-R1.0	■	■	■	747-R1.0	■	■	■

7XX-XX-B



Sur demande pour serrage type B, voir page 1.03
 Wahlweise mit B-Spannsystem, siehe Seite 1.03
 On request for B clamping system, see page 1.03

Plaquettes ébauches
WSP-Rohlinge
Blank inserts

731-E / 741-E
731-EP / 741-EP

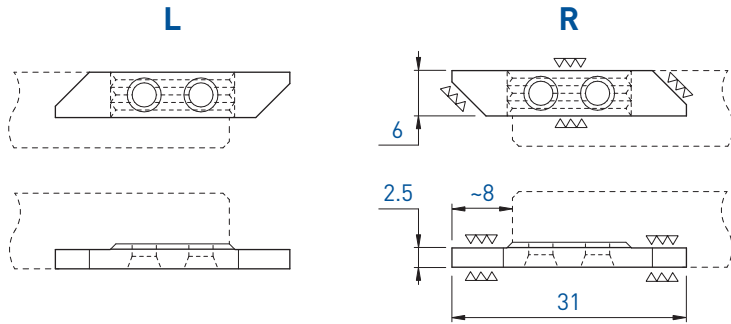
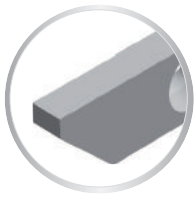

L			R		
Art. N°	N (µk20)	HN (µk10)	Art. N°	N (µk20)	HN (µk10)
731-E	■	■	741-E	■	■

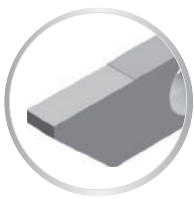

Face de coupe polie
Polierte Schneidfläche
Polished cutting face

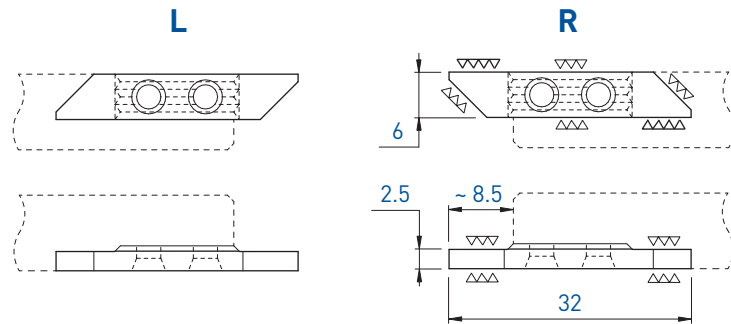

L						R							
Art. N°	TiAlN	TiN	N (µk20)	HTA	HTiN	HN (µk10)	Art. N°	TiAlN	TiN	N (µk20)	HTA	HTiN	HN (µk10)
731-EP	■	■	■	■	■	■	741-EP	■	■	■	■	□	■

7XX-XX-B



Sur demande pour serrage type B,
voir page 1.03
Wahlweise mit B-Spannsystem,
siehe Seite 1.03
On request for B clamping system,
see page 1.03

■ = disponible / verfügbar / available
□ = selon disponibilité du stock / jenach Lagerverfügbarkeit / depending on stock availability

L			R		
Type		Page	Type		Page
750	750	1.70	760	760	1.70
	750-JET	1.71		760/750-D	1.75/1.76
	750RC	1.72		760/750-AX	1.77
751	751	1.78	760-JET	1.71	
	751-E	1.131	760LC	1.73	
	751NXF	1.87/1.97	760-NOVIBRA	1.74	
	751R	1.88	761	761	1.78
	751-R05	1.80		761-E	1.131
	751RAS	1.99		761L	1.88
	751RD	1.98		761LD	1.98
	751R-R05	1.90		761L-R05	1.90
	751RS	1.89		761LS	1.89
	751RU	1.95		761LX12	1.93
	751RZU	1.96		761LX25	1.94
	751RX12	1.93		761LX4	1.91
	751RX25	1.94		761LXF	1.92
	751RX4	1.91		761NXF	1.87/1.97
	751RXF	1.92		761-R05	1.80
	751S	1.79		761S	1.79
	751U	1.85		761U	1.85
	751X12	1.83		761ZU	1.86
	751X25	1.84		761X12	1.83
	751X4	1.81		761X25	1.84
751XF	1.82	761X4		1.81	
752	752	1.100		761XF	1.82
	752PX	1.101		762	762
	752S	1.106	762PX		1.101
	752X	1.102	762S		1.105
753	753	1.107	762X		1.102
	753P	1.116	762VX-800	1.103	
	753S	1.106	762ZX	1.104	
	753VX-15°	1.113	763	763	1.107
	753VX-8°	1.110		763P	1.116
	753VX-805	1.111		763S	1.106
	753X	1.108		763VUX	1.114
	753XS	1.109		763VX-15°	1.113
	753ZX10	1.115		763VX-8°	1.110
	754	754		1.117	763VX-800
754VS		1.118		763VX-805	1.111
754X		1.119		763X	1.108
754ZX		1.122		763XS	1.109
756	754ZXT	1.124	763ZX10	1.115	
	756-55	1.125	764	764	1.117
	756-60	1.125		764VS	1.118
	756-AG60°	1.126		764X	1.119
	756-G60°	1.126		764X5	1.120
756-M	1.127	764X10		1.121	
757	757	1.129	764ZX	1.122	
	757ZX	1.130	764ZXB	1.123	
			764ZXT	1.124	
			766	766	1.125
				766-AG60°	1.126
				766-G60°	1.126
				766-M	1.127
				766ZX	1.128
			767	767	1.129
				767ZX	1.130

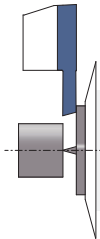
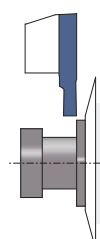
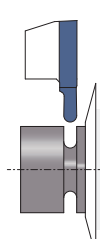
		750 / 760 Porte-outils Halter Holders	> 1.70
	751 / 761 Tronçonnage Abstechen Parting off		> 1.78
		761L / 751R Tronçonnage - coupe déportée Abstechen - versetztes Schneiden Parting off - cut off line	> 1.88
	752 / 762 Tournage avant Vorwärts drehen Front turning		> 1.100
		753 / 763 Tournage arrière Rückwärts drehen Back turning	> 1.106
	754 / 764 Fonçage-tournage Einstecken und drehen Grooving and turning		> 1.117
		756 / 766 Filetage Gewinde drehen Threading	> 1.125
	757 / 767 Plaquettes à rayon Radius Wendeplatten Radius inserts		> 1.129
		Plaquettes ébauches WSP-Rohlinge Blank inserts	> 1.131

L

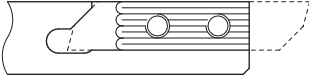

R

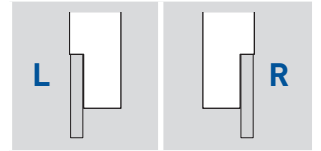
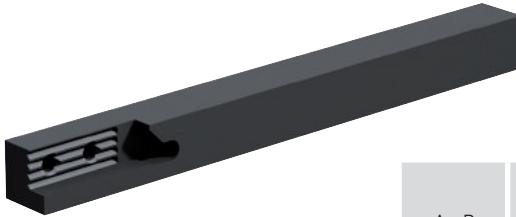
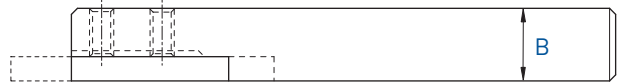
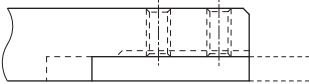
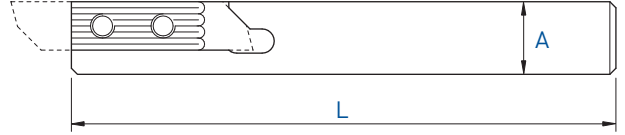

Serrage standard A
Standard Spannsystem A
Standard clamping system A

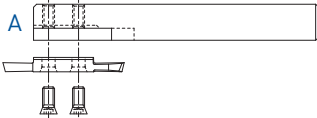

A x B	L	Serrage Spannsystem Clamping	Art. N°	Art. N°
10 x 10	115	A	750-10	760-10
10 x 10	115	A + B	750-10-AB	760-10-AB
10 x 10	50	A	750-10-50	760-10-50
12 x 12	130	A	750-12	760-12
12 x 12	130	A + B	750-12-AB	760-12-AB
12 x 12	90	A	750-12-90	760-12-90
12 x 12	90	A + B	750-12-90-AB	760-12-90-AB
12.7 x 12.7	130	A + B	750-12.7	760-12.7
14 x 14	130	A + B	750-14	760-14
16 x 16	130	A + B	750-16	760-16
16 x 16	75	A + B	750-16-75	760-16-75
20 x 20	120	A + B	750-20	760-20
25 x 25	140	A	760/750-25	

Serrage A + B
Spannsystem A + B
Clamping system A + B

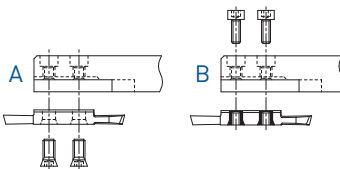

760/750-25
R + L



Chaque support est livré avec vis et clé.
Jeder Halter wird mit Spannschraube(n) und Schlüssel geliefert.
Screw(s) and key are included with each tool holder.

Porte-outils avec arrosage intégré
 Halter mit integrierter Kühlmittelzufuhr
 Holders with integrated coolant supply

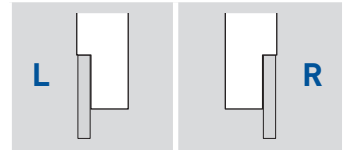
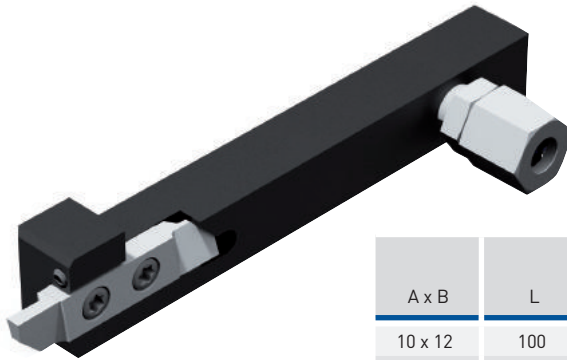
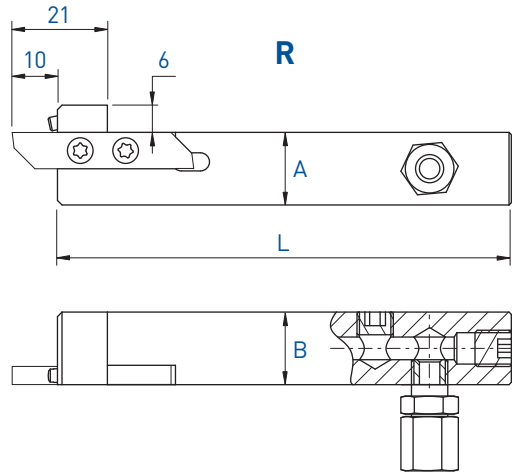
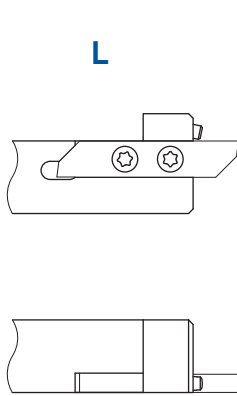

750-JET / 760-JET



A x B	L	Serrage Spannsystem Clamping	Art. N°	Art. N°
10 x 12	100	A + B	750-1012-JET	760-1012-JET
10 x 12	80	A + B	-	760-1012-80-JET new
12 x 12	100	A + B	750-12-JET	760-12-JET
12.7 x 12.7	100	A + B	750-12.7-JET	760-12.7-JET
16 x 16	100	A + B	750-16-JET	760-16-JET
20 x 20	100	A + B	750-20-JET	760-20-JET

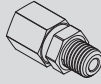

Chaque support est livré avec vis et clé.
 Jeder Halter wird mit Spannschraube(n)
 und Schlüssel geliefert.
 Screw(s) and key are included with each
 tool holder.

Pièces de rechange Ersatzteile Spare parts			Buse Düse Nozzle 
	Art. N°	Art. N°	Art. N°
750-JET / 760-JET	J-M8X1-D6	JB-M8X1	JJ-M3X6-D1.5

Porte-outils
Halter
Holder

Coupe à droite déportée
Versetztes Rechtsschneiden
Right cut off line

750RC

Utiliser des plaquettes type 751R
 WSP Typ 751R verwenden
 Use inserts type 751R

Voir pages 1.88 - 1.99
 Siehe Seiten 1.88 - 1.99
 See pages 1.88 - 1.99

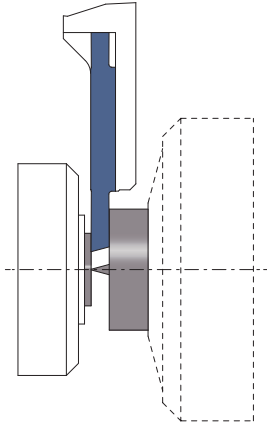
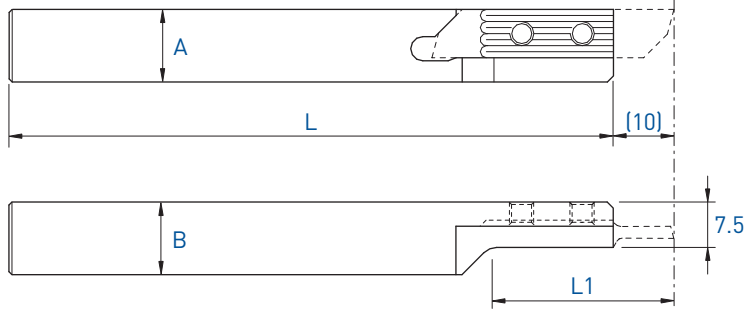

L (R)			
Coupe à droite déportée Versetztes Rechtsschneiden Right cut off line			
A x B	L	L1	Art. N°
12 x 12	130	30	750RC-12
16 x 16	130	40	750RC-16

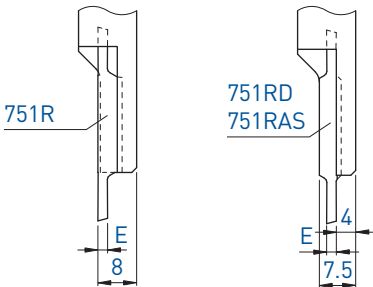

(p. 1.98 - 1.99)

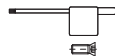

Chaque support est livré avec vis et clé.
 Jeder Halter wird mit Spannschraube(n) und Schlüssel geliefert.
 Screw(s) and key are included with each tool holder.

Porte-outils

Halter

Holder

Coupe à gauche déportée

Versetztes Linksschneiden

Left cut off line

760LC

Utiliser des plaquettes type 761L
WSP Typ 761L verwenden
Use insets type 761L

Voir pages 1.88 - 1.94 + 1.98
Siehe Seiten 1.88 - 1.94 + 1.98
See pages 1.88 - 1.94 + 1.98

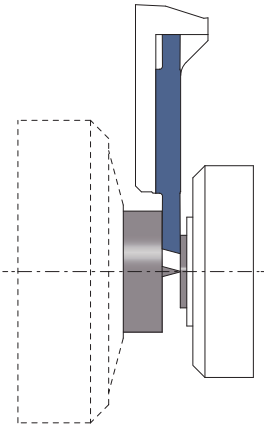
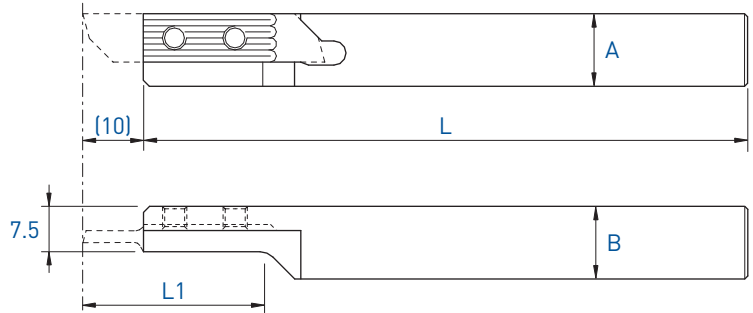

R (L)

Coupe à gauche déportée
Versetztes Linksschneiden
Left cut off line

A x B	L	L1	Art. N°
16 x 16	130	40	760LC-16

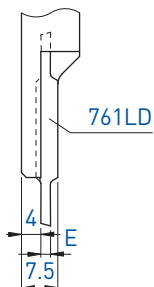
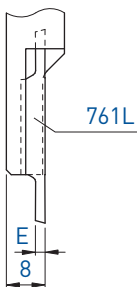

(p. 1.98)



Chaque support est livré avec vis et clé.
Jeder Halter wird mit Spannschraube(n) und Schlüssel geliefert.
Screw(s) and key are included with each tool holder.

R

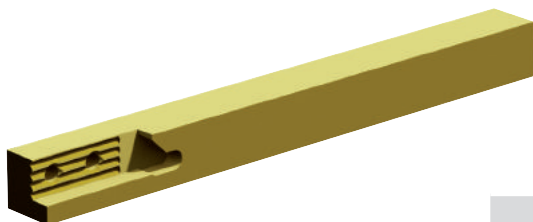
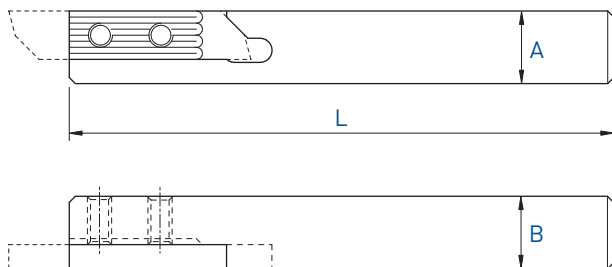

A x B	L	Serrage Spannsystem Clamping	Art. N°
10 x 10	115	A	760-10-NOVIBRA
12 x 12	130	A	760-12-NOVIBRA

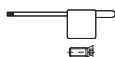

Chaque support est livré avec vis et clé.
 Jeder Halter wird mit Spannschraube(n) und Schlüssel geliefert.
 Screw(s) and key are included with each tool holder.

Porte-outils

Halter

Holders

760 / 750-D10

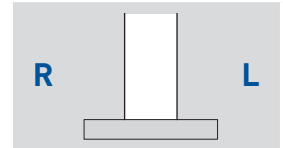
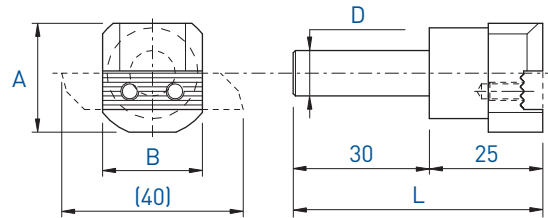

A x B	L	D	Art. N°
24 x 22	55	10	760/750-D10



Chaque support est livré avec vis et clé.
 Jeder Halter wird mit Spannschraube(n) und Schlüssel geliefert.
 Screw(s) and key are included with each tool holder.

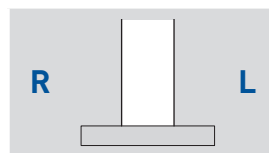
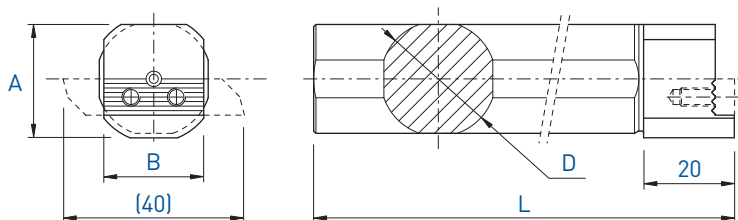

A x B	L	D	Art. N°
25 x 22	160	16	760/750-D16
25 x 22	160	19.05	760/750-D19.05
25 x 22	110	19.05	760/750-D19.05-S
25 x 22	160	20	760/750-D20
25 x 22	110	22	760/750-D22
25 x 22	200	25	760/750-D25
25 x 22	200	25.4	760/750-D25.4
25 x 22	125	25.4	760/750-D25.4-S

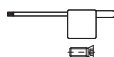

Chaque support est livré avec vis et clé.
 Jeder Halter wird mit Spannschraube(n) und Schlüssel geliefert.
 Screw(s) and key are included with each tool holder.

Porte-outils

Halter

Holders

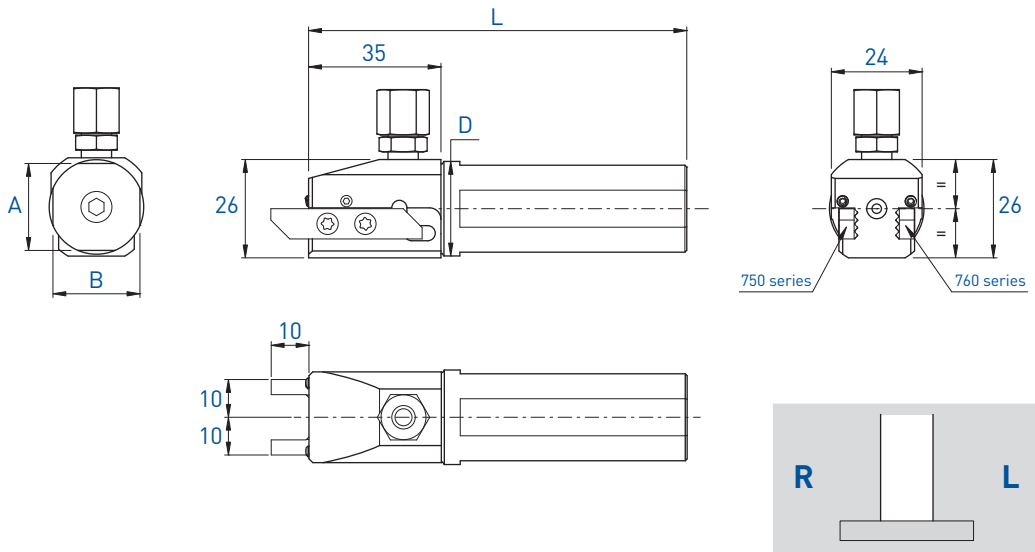

760 / 750-AX

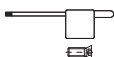

A x B	L	D	Art. N°
23 x 23	100	25	760/750-AX-D25-JET
23 x 23	100	25.4	760/750-AX-D25.4-JET

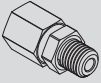

Chaque support est livré avec vis et clé.
 Jeder Halter wird mit Spannschraube(n)
 und Schlüssel geliefert.
 Screw(s) and key are included with each
 tool holder.

Pièces de rechange Ersatzteile Spare parts			Buse Düse Nozzle 
	Art. N°	Art. N°	Art. N°
760/750-AX	J-M8X1-D6	JB-M8X1	JJ-M3X6-D1.5

Tronçonnage

Abstechen

Parting off

751 / 761

L

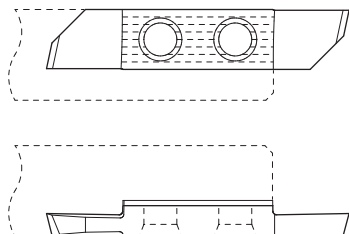

R

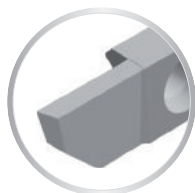
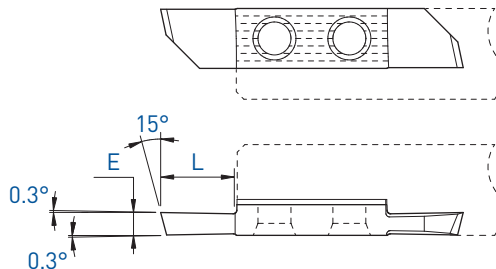

L



R



E	L	Art. N°	TiAlN	TiN	N (µk20)	HTA	HTiN	HN (µk10)	Art. N°	TiAlN	TiAlX	TiN	N (µk20)	HTA	HTiN	HN (µk10)
1.0	5	751-1.0	■	■	■	■	□	■	761-1.0	■	■	■	■	■	■	■
1.2	5	751-1.2	■	■	■				761-1.2	■	■	■	■	■	□	■
1.5	7.5	751-1.5	■	■	■	■	□	■	761-1.5	■	■	■	■	■	■	■
1.8	7.5	751-1.8	■	■	■				761-1.8	■	■	■	■	■	□	■
2.0	10	751-2.0	■	■	■	■	□	■	761-2.0	■	■	■	■	■	■	■
2.2	10	751-2.2	■	■	■				761-2.2	■	■	■	■	■	□	■
2.5	10	751-2.5	■	■	■	■	□	■	761-2.5	■	■	■	■	■	■	■
3.0	10	751-3.0	■	■	■				761-3.0	■	■	■	■	■	□	■

7XX-XX-B



Sur demande pour serrage type B, voir page 1.03
Wahlweise mit B-Spannsystem, siehe Seite 1.03
On request for B clamping system, see page 1.03

Tronçonnage
Abstechen
Parting off

751S / 761S

L

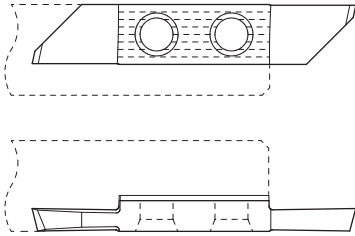

R

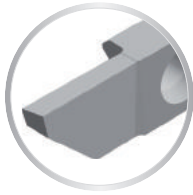
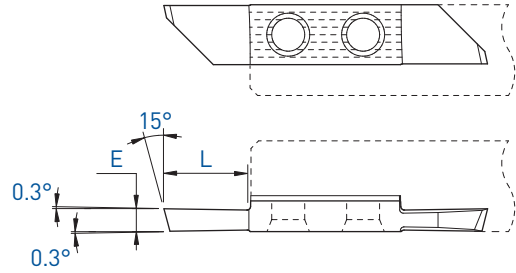

L



R



E	L	Art. N°	TiAlN	TiN	N (µk20)	HTA	HTiN	HN (µk10)	Art. N°	TiAlN	TiAlX	TiN	N (µk20)	HTA	HTiN	HN (µk10)
2.0	11.5	751S-2.0	■	■	■	■	□	■	761S-2.0	■	■	■	■	■	□	■
2.2	11.5	751S-2.2	■	■	■				761S-2.2	■	■	■	■	■	□	■
2.5	11.5	751S-2.5	■	■	■	■	□	■	761S-2.5	■	■	■	■	■	□	■
3.0	11.5	751S-3.0	■	■	■				761S-3.0	■	■	■	■	■	□	■

7XX-XX-B



Sur demande pour serrage type B, voir page 1.03
Wahlweise mit B-Spannsystem, siehe Seite 1.03
On request for B clamping system, see page 1.03

■ = disponible / verfügbar / available
□ = selon disponibilité du stock / jenach Lagerverfügbarkeit / depending on stock availability

Tronçonnage
Abstechen
Parting off

751-R05 / 761-R05

L

R

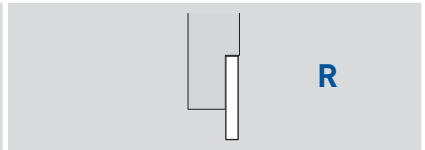
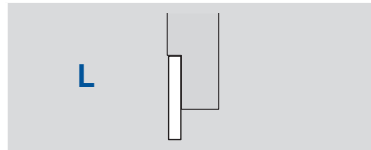
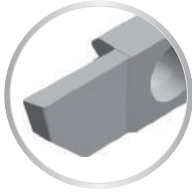
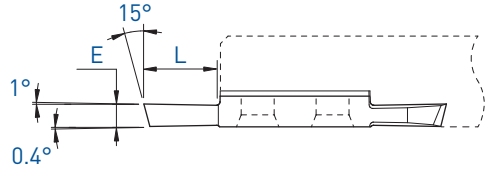
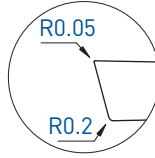
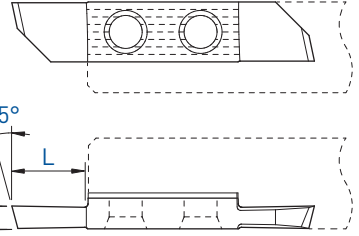
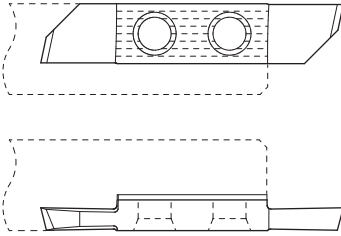

E	L	Art. N°	L			R			HTA	HTiN	HN [µk10]		
			TiAlN	TiN	N [µk20]	TiAlN	TiAlX	TiN				N [µk20]	
1.5	7.5	751-1.5-R05	■	■	■						■	□	■
2.0	10	751-2.0-R05	■	■	■						■	□	■
2.5	10	751-2.5-R05	■	■	■						■	□	■

7XX-XX-B

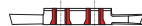

Sur demande pour serrage type B, voir page 1.03
Wahlweise mit B-Spannsystem, siehe Seite 1.03
On request for B clamping system, see page 1.03

Tronçonnage
Abstechen
Parting off

751X4 / 761X4

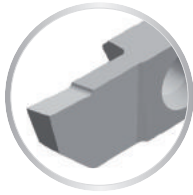
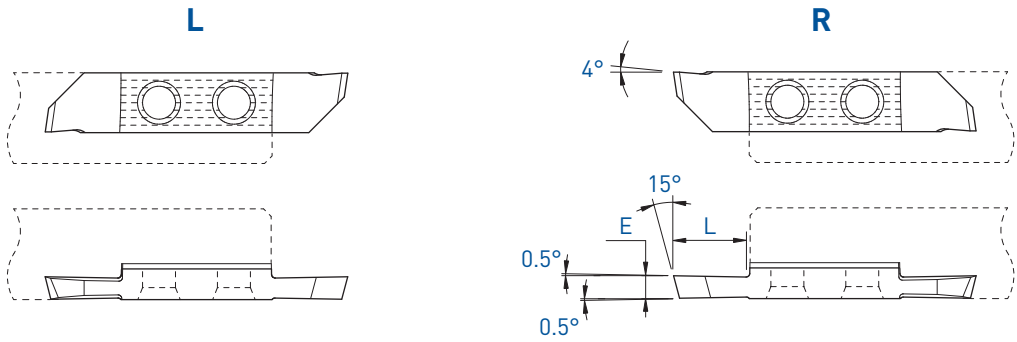

		L						R							
E	L	Art. N°	TiAlN	TiN	N (µk20)	HTA	HTiN	HN (µk10)	Art. N°	TiAlN	TiN	N (µk20)	HTA	HTiN	HN (µk10)
1.5	7.5	-	■	■	■	■	□	■	761X4-1.5	■	■	■	■	□	■
2.0	10	751X4-2.0	■	■	■	■	□	■	761X4-2.0	■	■	■	■	□	■
2.5	10	-	■	■	■	■	■	■	761X4-2.5	■	■	■	■	■	■

■ = disponible / verfügbar / available
□ = selon disponibilité du stock / jenach Lagerverfügbarkeit / depending on stock availability



7XX-XX-B
Sur demande pour serrage type B, voir page 1.03
Wahlweise mit B-Spannsystem, siehe Seite 1.03
On request for B clamping system, see page 1.03

TOP-LINE

- Tronçonnage
- Abstechen
- Parting off

751XF / 761XF

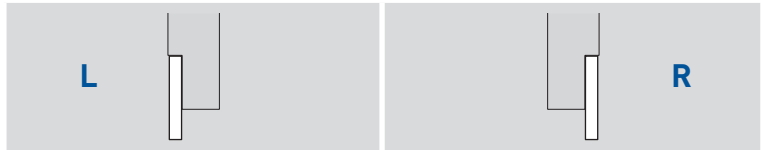
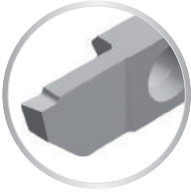
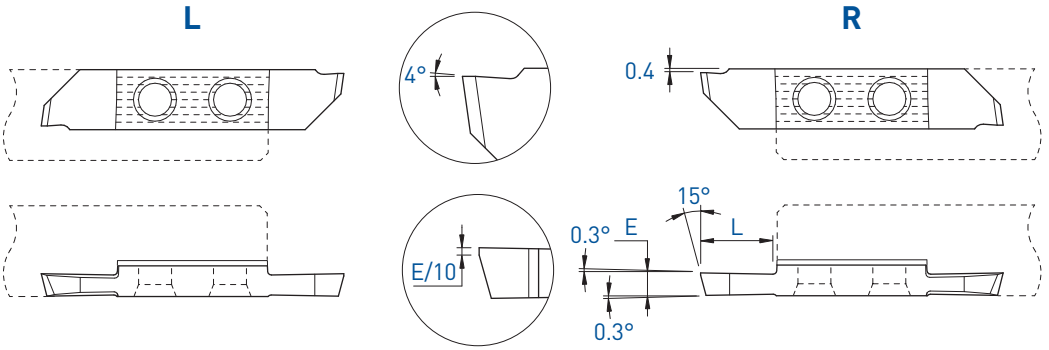

E	L	Art. N°	L			R									
			TiAlN	TiN	N (µk20)	HTA	HTiN	HN (µk10)	Art. N°	TiAlN	TiN	N (µk20)	HTA	HTiN	HN (µk10)
1.5	7.5	751XF-1.5	■	■	■	■	□	■	761XF-1.5	■	■	■	■	□	■
2.0	10	751XF-2.0	■	■	■	■	■	■	761XF-2.0	■	■	■	■	■	■
2.2	10	751XF-2.2	■	■	■				761XF-2.2	■	■	■			
2.5	10	751XF-2.5	■	■	■	■	□	■	761XF-2.5	■	■	■			
3.0	10	751XF-3.0	■	■	■				761XF-3.0	■	■	■	■	□	■

7XX-XX-B



Sur demande pour serrage type B, voir page 1.03
 Wahlweise mit B-Spannsystem, siehe Seite 1.03
 On request for B clamping system, see page 1.03

Tronçonnage

Abstechen

Parting off

751X12 / 761X12

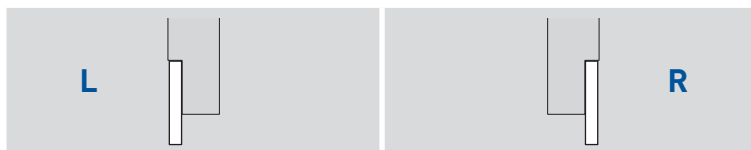
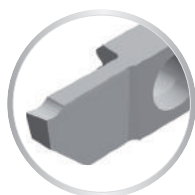
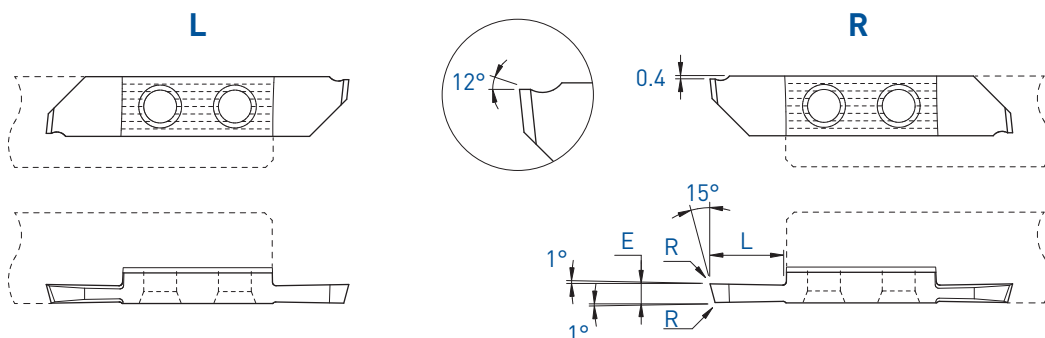

E	L	R	Art. N°	TiAlN	TiN	N (µk20)	HTA	HTiN	HN (µk10)	Art. N°	TiAlN	TiN	N (µk20)	HTA	HTiN	HN (µk10)
1.5	7.5	0.03	751X12-1.5	■	■	■	■	□	■	761X12-1.5	■	■	■	■	□	■
2.0	10	0.03	751X12-2.0	■	■	■	■	□	■	761X12-2.0	■	■	■	■	□	■
2.5	10	0.03	751X12-2.5	■	■	■	■			761X12-2.5	■	■	■	■	□	■

7XX-XX-B



Sur demande pour serrage type B, voir page 1.03
Wahlweise mit B-Spannsystem, siehe Seite 1.03
On request for B clamping system, see page 1.03

■ = disponible / verfügbar / available

□ = selon disponibilité du stock / jenach Lagerverfügbarkeit / depending on stock availability

- Tronçonnage
- Abstechen
- Parting off

751X25 / 761X25

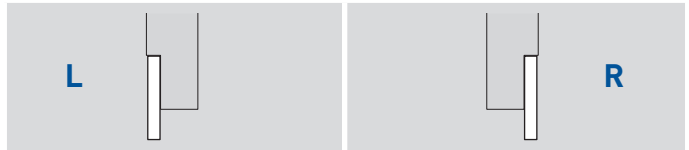
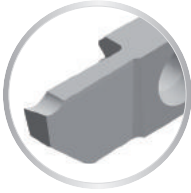
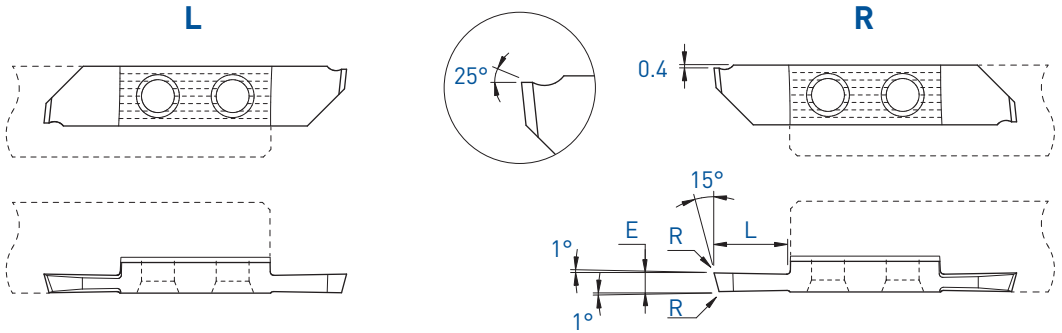

			L						R							
E	L	R	Art. N°	TiAlN	TiN	N (µk20)	HTA	HTiN	HN (µk10)	Art. N°	TiAlN	TiN	N (µk20)	HTA	HTiN	HN (µk10)
1.5	7.5	0.03	751X25-1.5	■	■	■	■	□	■	761X25-1.5	■	■	■			
2.0	10	0.03	751X25-2.0	■	■	■				761X25-2.0	■	■	■	■	□	■
2.5	10	0.03	751X25-2.5	■	■	■				761X25-2.5	■	■	■	■	□	■

7XX-XX-B

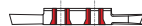

Sur demande pour serrage type B, voir page 1.03
 Wahlweise mit B-Spannsystem, siehe Seite 1.03
 On request for B clamping system, see page 1.03

Tronçonnage

Abstechen

Parting off

751U / 761U

L

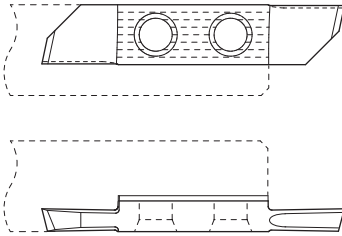

R

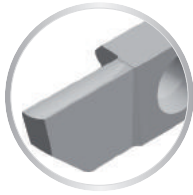
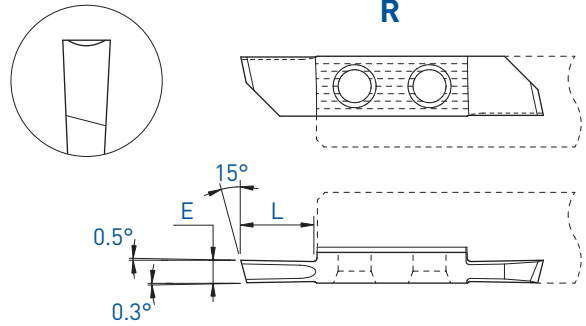

L



R



E	L	Art. N°	TiAlN	TiN	N (µk20)	HTA	HTiN	HN (µk10)	Art. N°	TiAlN	TiN	N (µk20)	HTA	HTiN	HN (µk10)
1.5	7.5	-							761U-1.5	■	□	■	■	□	■
2.0	10	751U-2.0	■	■	■				761U-2.0	■	■	■	□	□	■

7XX-XX-B



Sur demande pour serrage type B, voir page 1.03
Wahlweise mit B-Spannsystem, siehe Seite 1.03
On request for B clamping system, see page 1.03

■ = disponible / verfügbar / available

□ = selon disponibilité du stock / jenach Lagerverfügbarkeit / depending on stock availability

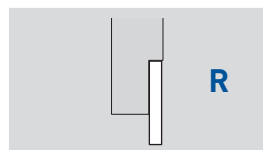
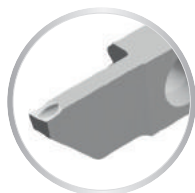
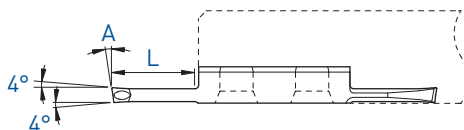
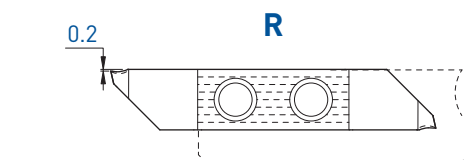
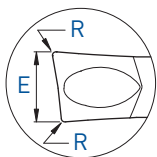
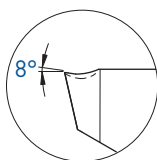

E	A	L	R	Art. N°	TiAlN N (µm20)
2.0	0°	11	0.10	761ZU8-2.0-R10	■
2.0	8°	11	0.10	761ZU8-2.0-8°-R10	■

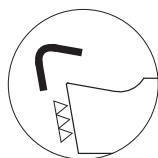

Arête de coupe honée
Gehonte Schneidkante
Honed edge

f min: 0.02 mm/U

7XX-XX-B



Sur demande pour serrage type B, voir page 1.03
Wahlweise mit B-Spannsystem, siehe Seite 1.03
On request for B clamping system, see page 1.03

Tronçonnage

Abstechen

Parting off

751NXF / 761NXF

L

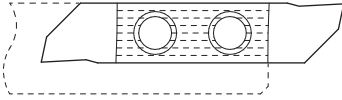

R

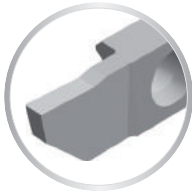
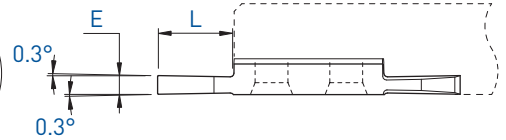
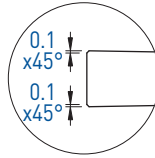
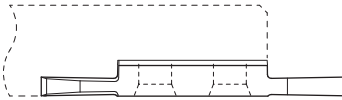
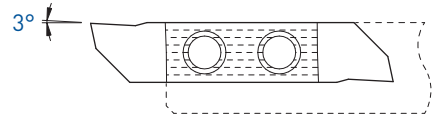

L



R



E	L	Art. N°	TiAlN	TiN	N (µk20)	HTA	HTiN	HN (µk10)	Art. N°	TiAlN	TiN	N (µk20)	HTA	HTiN	HN (µk10)
2.0	10	751NXF-2.0	■	■	■	■	□	■	761NXF-2.0	■	■	■	■	□	■
2.5	10	751NXF-2.5	■	■	■				761NXF-2.5	■	■	■			
3.0	10	751NXF-3.0	■	■	■				761NXF-3.0	■	■	■			

7XX-XX-B



Sur demande pour serrage type B, voir page 1.03
Wahlweise mit B-Spannsystem, siehe Seite 1.03
On request for B clamping system, see page 1.03

Tronçonnage

Abstechen

Parting off

Coupe déportée

Versetztes Schneiden

Cut off line

761L / 751R

Cut L

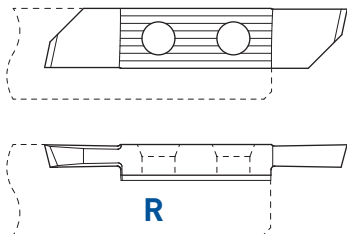

Cut R

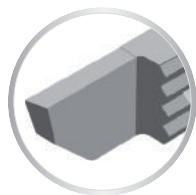
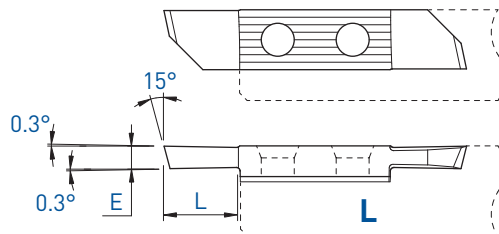

R (L)

Coupe à gauche déportée
Versetztes Linksschneiden
Left cut off line

L (R)

Coupe à droite déportée
Versetztes Rechtsschneiden
Right cut off line

E	L	Art. N°	TiAlN	TiN	N (µk20)	HTA	HTiN	HN (µk10)	Art. N°	TiAlN	TiAlX	TiN	N (µk20)	HTA	HTiN	HN (µk10)
1.0	5	761L-1.0	■	■	■	■	□	■	751R-1.0	■	■	■	■	■	□	■
1.5	7.5	761L-1.5	■	■	■	■	□	■	751R-1.5	■	■	■	■	■	□	■
1.8	7.5	761L-1.8	■	■	■				751R-1.8	■	■	■	■	■	□	■
2.0	10	761L-2.0	■	■	■	■	□	■	751R-2.0	■	■	■	■	■	■	■
2.2	10	761L-2.2	■	■	■				751R-2.2	■	■	■	■			
2.5	10	761L-2.5	■	■	■	■	□	■	751R-2.5	■	■	■	■	■	■	■
3.0	10	761L-3.0	■	■	■				751R-3.0	■	■	■	■	■	□	■

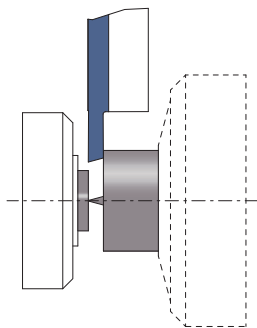

Tronçonnage
Abstechen
Parting off

Coupe déportée
Versetztes Schneiden
Cut off line

761LS / 751RS

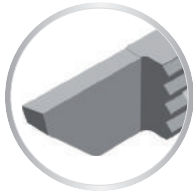
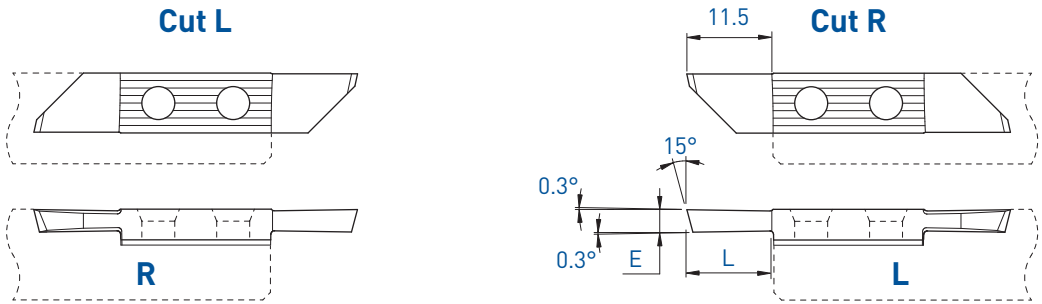

R (L)	L (R)
Coupe à gauche déportée Versetztes Linksschneiden Left cut off line	Coupe à droite déportée Versetztes Rechtsschneiden Right cut off line

E	L	Art. N°	TiAlN	TiN	N (µk20)	HTA	HTiN	HN (µk10)	Art. N°	TiAlN	TiAlX	TiN	N (µk20)	HTA	HTiN	HN (µk10)
1.0	5.5	761LS-1.0	■	■	■	■	□	■	751RS-1.0	■	■	■	■	■	□	■
1.5	8	761LS-1.5	■	■	■	■	□	■	751RS-1.5	■	■	■	■	■	□	■
2.0	11.5	761LS-2.0	■	■	■				751RS-2.0	■	■	■	■	■	■	■
2.2	11.5	761LS-2.2	■	■	■				751RS-2.2	■	■	■	■	■	□	■
2.5	11.5	761LS-2.5	■	■	■				751RS-2.5	■	■	■	■	■	□	■
3.0	11.5	761LS-3.0	■	■	■				751RS-3.0	■	■	■	■	■	□	■

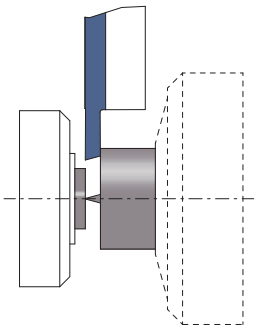

TOP-LINE

Tronçonnage
Abstechen
Parting off

Coupe déportée
Versetztes Schneiden
Cut off line

761L-R05 / 751R-R05

Cut L

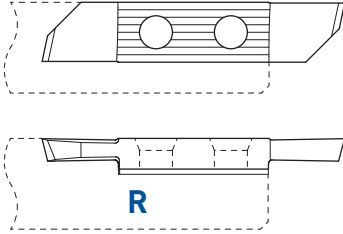

Cut R

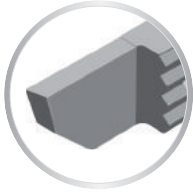
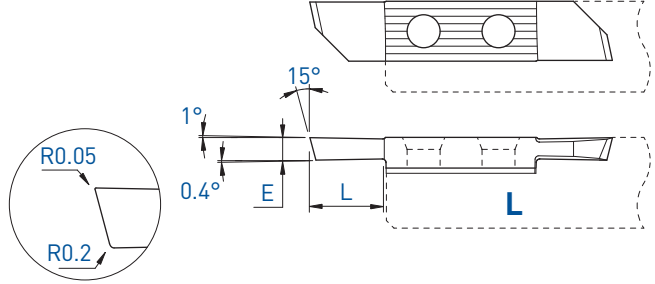

R (L)

Coupe à gauche déportée
Versetztes Linksschneiden
Left cut off line

L (R)

Coupe à droite déportée
Versetztes Rechtsschneiden
Right cut off line

E	L	Art. N°	TiAlN	TiN	N (µk20)	HTA	HTiN	HN (µk10)	Art. N°	TiAlN	TiAlX	TiN	N (µk20)	HTA	HTiN	HN (µk10)
1.5	7.5	761L-1.5-R05	■	■	■				751R-1.5-R05	■	■	■	■	■	□	■
2.0	10	761L-2.0-R05	■	■	■				751R-2.0-R05	■	■	■	■			

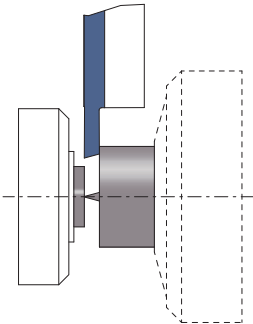

Tronçonnage
Abstechen
Parting off

Coupe déportée
Versetztes Schneiden
Cut off line

761LX4 / 751RX4

Cut L

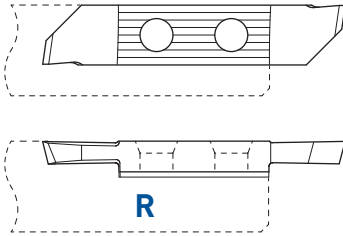

Cut R

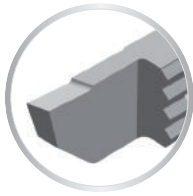
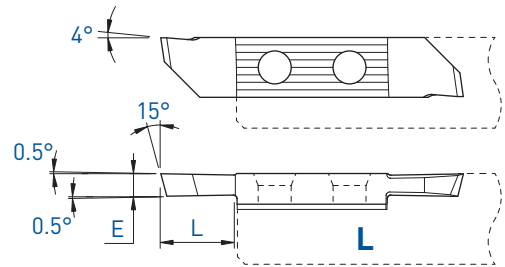

R (L)

Coupe à gauche déportée
Versetztes Linksschneiden
Left cut off line

L (R)

Coupe à droite déportée
Versetztes Rechtsschneiden
Right cut off line

E	L	Art. N°	TiAlN	TiN	N [µk20]	HTA	HTiN	HN [µk10]	Art. N°	TiAlN	TiN	N [µk20]	HTA	HTiN	HN [µk10]
1.5	7.5	-							751RX4-1.5	■	■	■	■	■	■
2.0	10	761LX4-2.0	■	■	■				751RX4-2.0	■	■	■	■	■	■
2.5	10	-							751RX4-2.5	■	■	■			

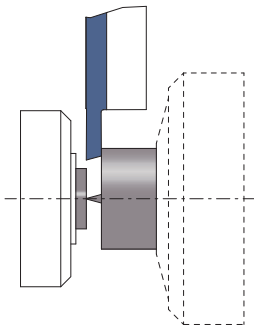

Tronçonnage
Abstechen
Parting off

Coupe déportée
Versetztes Schneiden
Cut off line

761LXF / 751RXF

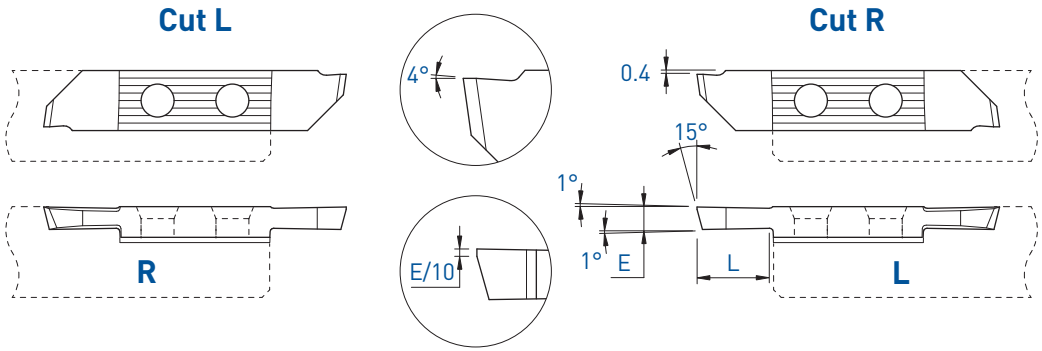

R (L)	L (R)
Coupe à gauche déportée Versetztes Linksschneiden Left cut off line	Coupe à droite déportée Versetztes Rechtsschneiden Right cut off line

E	L	Art. N°	TiAlN	TiN	N (µk20)	HTA	HTiN	HN (µk10)	Art. N°	TiAlN	TiN	N (µk20)	HTA	HTiN	HN (µk10)
1.5	7.5	-	■	■	■				751RXF-1.5	■	■	■	■	□	■
2.0	10	761LXF-2.0	■	■	■				751RXF-2.0	■	■	■	■	■	■
2.5	10	761LXF-2.5	■	■	■				751RXF-2.5	■	■	■	■	□	■
3.0	10	761LXF-3.0	■	■	■				751RXF-3.0	■	■	■	■	□	■

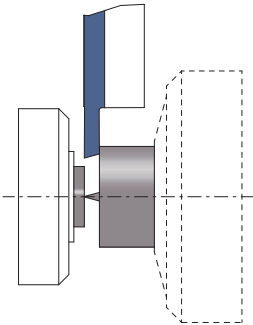

Tronçonnage
Abstechen
Parting off

Coupe déportée
Versetztes Schneiden
Cut off line

761LX12 / 751RX12

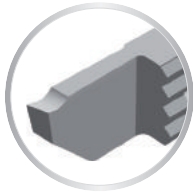
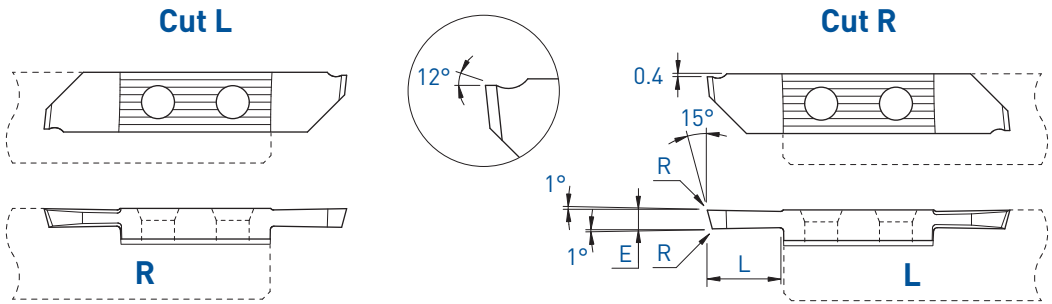

			R (L) Coupe à gauche déportée Versetztes Linksschneiden Left cut off line					L (R) Coupe à droite déportée Versetztes Rechtsschneiden Right cut off line								
E	L	R	Art. N°	TiAlN	TiN	N (µk20)	HTA	HTiN	HN (µk10)	Art. N°	TiAlN	TiN	N (µk20)	HTA	HTiN	HN (µk10)
1.5	7.5	0.03	-							751RX12-1.5	■	■	■			
2.0	10	0.03	761LX12-2.0	■	■	■				751RX12-2.0	■	■	■	■	■	■

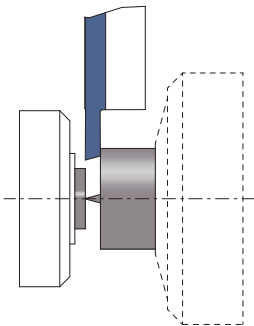

TOP-LINE

Tronçonnage
Abstechen
Parting off

Coupe déportée
Versetztes Schneiden
Cut off line

761LX25 / 751RX25

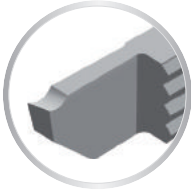
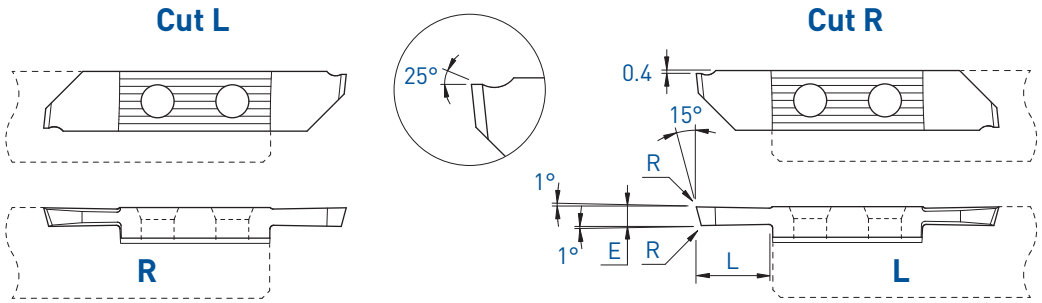

R (L)	L (R)
Coupe à gauche déportée Versetztes Linksschneiden Left cut off line	Coupe à droite déportée Versetztes Rechtsschneiden Right cut off line

E	L	R	Art. N°	TiAIN	TiN	N (µk20)	Art. N°	TiAIN	TiN	N (µk20)
2.0	10	0.03	761LX25-2.0	■	■	■	751RX25-2.0	■	■	■

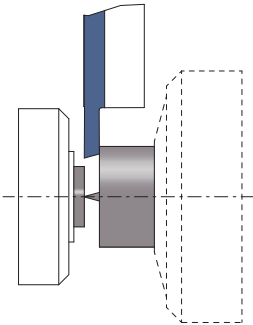

Tronçonnage
Abstechen
Parting off

Coupe déportée
Versetztes Schneiden
Cut off line

751RU

Cut R

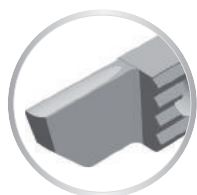
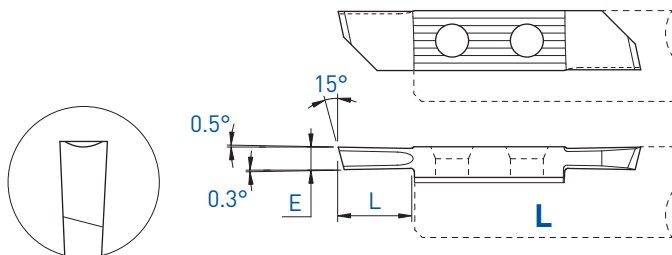

L (R)
Coupe à droite déportée
Versetztes Rechtsschneiden
Right cut off line

E	L	Art. N°	TiAIN	TiN	N (µk20)
1.5	7.5	751RU-1.5	■	■	■
2.0	10	751RU-2.0	■	■	■

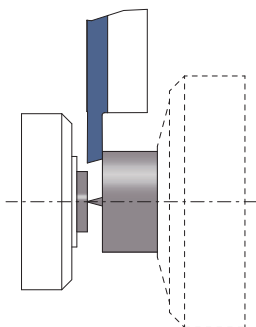

Tronçonnage

Abstechen

Parting off

Coupe déportée

Versetztes Schneiden

Cut off line

751RZU

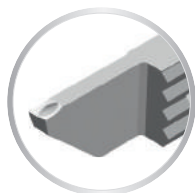
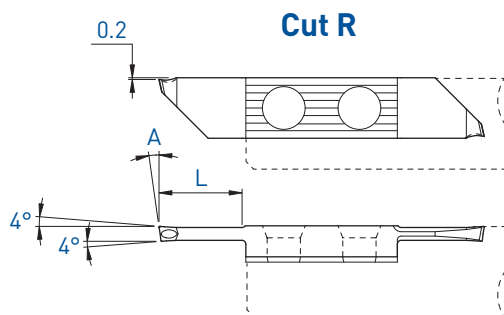
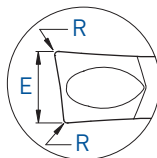
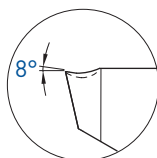

R (L)

Coupe à gauche déportée
Versetztes Linksschneiden
Left cut off line

E	A	L	R	Art. N°	TiAlN	TiN	N (µk20)
2.0	8°	11.0	0.10	751RZU8-2.0-8°-R10	■		

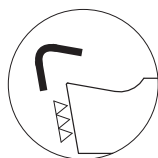

Arête de coupe honée
Gehonte Schneidkante
Honed edge

f min: 0.02 mm/U

Tronçonnage
Abstechen
Parting off

Coupe déportée
Versetztes Schneiden
Cut off line

761NXF / 751NXF

Cut L

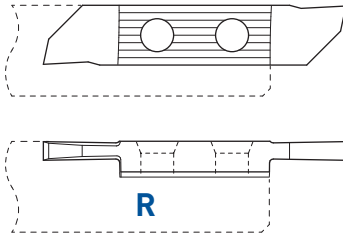

Cut R

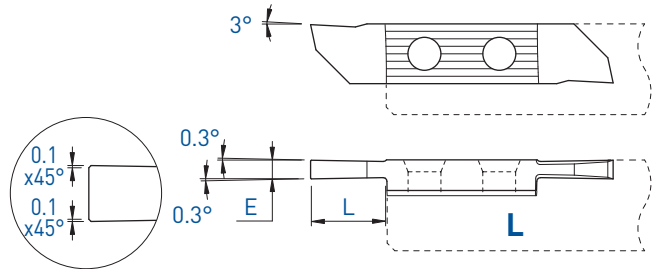

R (L)

Coupe à gauche déportée
Versetztes Linksschneiden
Left cut off line

L (R)

Coupe à droite déportée
Versetztes Rechtsschneiden
Right cut off line

E	L	Art. N°	TiAlN	TiN	N (µk20)	HTA	HTiN	HN (µk10)	Art. N°	TiAlN	TiN	N (µk20)	HTA	HTiN	HN (µk10)
2.0	10	761NXF-2.0	■	■	■	■	□	■	751NXF-2.0	■	■	■	■	□	■
2.5	10	761NXF-2.5	■	■	■				751NXF-2.5	■	■	■			
3.0	10	761NXF-3.0	■	■	■				751NXF-3.0	■	■	■			

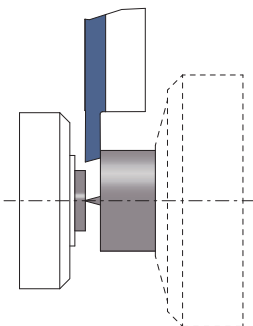

Tronçonnage
Abstechen
Parting off

Coupe déportée
Versetztes Schneiden
Cut off line

761LD / 751RD

Cut L

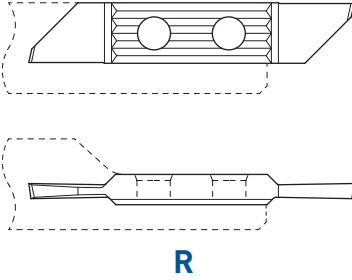

Cut R

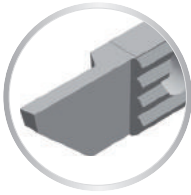
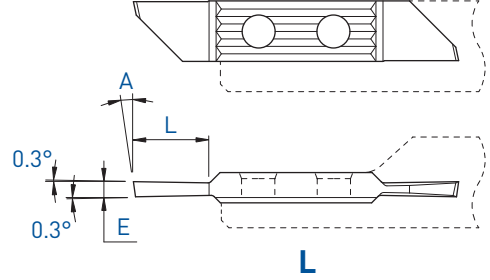

R (L)

Coupe à gauche déportée
Versetztes Linksschneiden
Left cut off line

L (R)

Coupe à droite déportée
Versetztes Rechtsschneiden
Right cut off line

E	A	L	Art. N°	Coatings			Coatings			Art. N°	Coatings					
				TiAlN	TiN	N (µk20)	HTA	HTiN	HN (µk10)		TiAlN	TiN	N (µk20)	HTA	HTiN	HN (µk10)
1.0	8°	5	761LD-1.0-8°	■	■	■	■	□	■	751RD-1.0-8°	■	■	■	■	□	■
1.0	15°	5	761LD-1.0-15°	■	■	■	■	□	■	751RD-1.0-15°	■	■	■	■	□	■
1.2	8°	5	761LD-1.2-8°	■	■	■				751RD-1.2-8°	■	■	■	■	□	■
1.5	8°	8	761LD-1.5-8°	■	■	■				751RD-1.5-8°	■	■	■	■	■	■
1.5	15°	8	761LD-1.5-15°	■	■	■				751RD-1.5-15°	■	■	■	■	□	■
1.6	8°	8	761LD-1.6-8°	■	■	■				751RD-1.6-8°	■	■	■			
1.8	8°	10	761LD-1.8-8°	■	■	■				751RD-1.8-8°	■	■	■	■	□	■
2.0	8°	10	761LD-2.0-8°	■	■	■				751RD-2.0-8°	■	■	■	■	□	■
2.0	15°	10	761LD-2.0-15°	■	■	■	■	□	■	751RD-2.0-15°	■	■	■	■	□	■
2.5	8°	10	-							751RD-2.5-8°	■	■	■	■	□	■

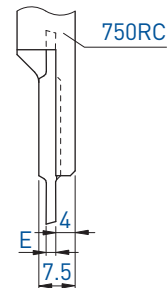
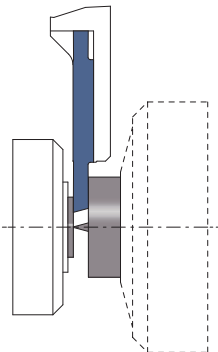

Tronçonnage
Abstechen
Parting off

Coupe déportée
Versetztes Schneiden
Cut off line

751RAS

Cut R

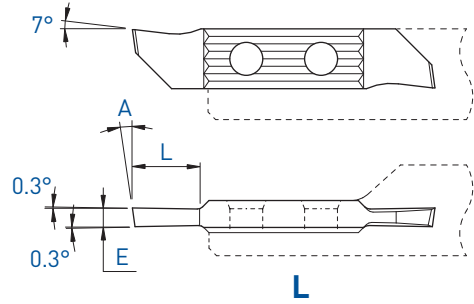

L (R)

Coupe à droite déportée
Versetztes Rechtsschneiden
Right cut off line

E	A	L	Art. N°	TiAlN	TiN	N (µk20)	HTA	HTiN	HN (µk10)
1.6	8°	7.5	751RAS-1.6-8°	■	■	■			
1.6	15°	7.5	751RAS-1.6-15°	■	■	■	■	□	■
2.0	8°	9	751RAS-2.0-8°	■	■	■	■	□	■
2.0	15°	9	751RAS-2.0-15°	■	■	■			
2.5	8°	9	751RAS-2.5-8°	■	■	■			
2.5	15°	9	751RAS-2.5-15°	■	■	■			

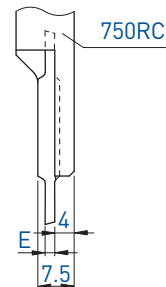
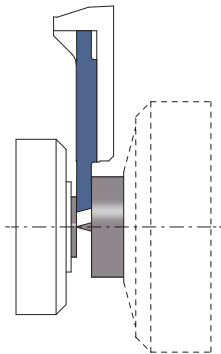

TOP-LINE

Tournage avant
Vorwärts drehen
Front turning

752 / 762

L

R

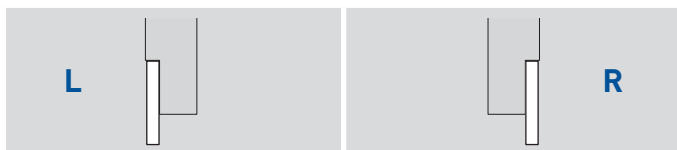
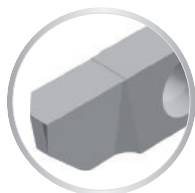
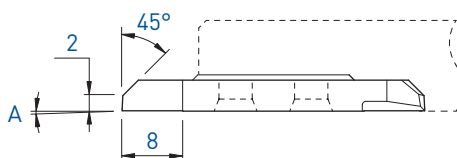
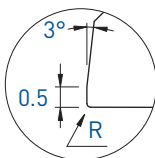
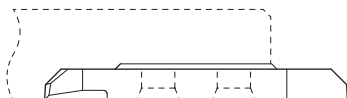
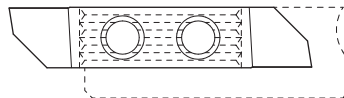
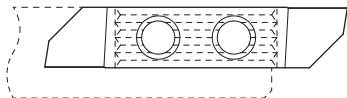

		L						R							
A	R	Art. N°	TiAlN	TiN	N (µk20)	HTA	HTiN	HN (µk10)	Art. N°	TiAlN	TiN	N (µk20)	HTA	HTiN	HN (µk10)
0°	0	752	■	■	■	■	□	■	762	■	■	■	■	□	■
0°	0.20	-							762-R20	■	■	■	■	□	■
3°	0	752-3°	■	■	■	■	□	■	762-3°	■	■	■	■	□	■

7XX-XX-B



Sur demande pour serrage type B, voir page 1.03
Wahlweise mit B-Spannsystem, siehe Seite 1.03
On request for B clamping system, see page 1.03

Tournage avant
Vorwärts drehen
Front turning

752PX / 762PX

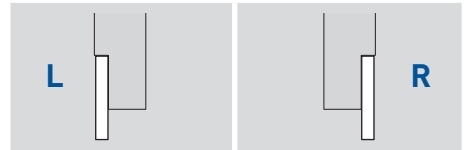
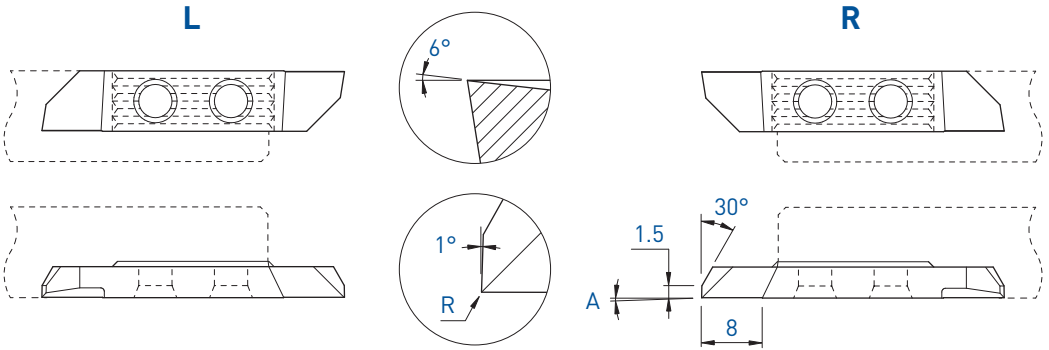

A	R	Art. N°	TiAlN	TiN	N [µk20]	Art. N°	TiAlN	TiN	N [µk20]
0°	0	752PX	■	■	■	762PX	■	■	■

7XX-XX-B

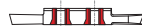

Sur demande pour serrage type B, voir page 1.03
Wahlweise mit B-Spannsystem, siehe Seite 1.03
On request for B clamping system, see page 1.03

■ = disponible / verfügbar / available
□ = selon disponibilité du stock / jenach Lagerverfügbarkeit / depending on stock availability

TOP-LINE

Tournage avant
Vorwärts drehen
Front turning

752X / 762X

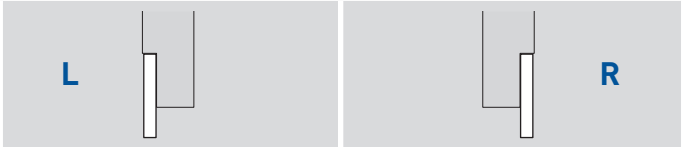
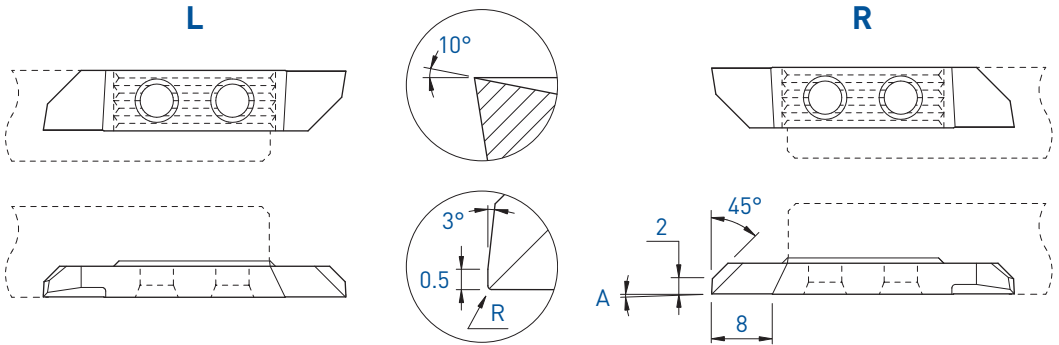

A	R	Art. N°	TiAlN	TiN	N (µk20)	HTA	HTiN	HN (µk10)	Art. N°	TiAlN	TiN	N (µk20)	HTA	HTiN	HN (µk10)
0°	0	752X	■	■	■	■	■	■	762X	■	■	■	■	■	■
0°	0.20	752X-R20	■	■	■				762X-R20	■	■	■	■	■	■

7XX-XX-B



Sur demande pour serrage type B, voir page 1.03
Wahlweise mit B-Spannsystem, siehe Seite 1.03
On request for B clamping system, see page 1.03

Tournage avant
 Vorwärts drehen
 Front turning

762VX-800

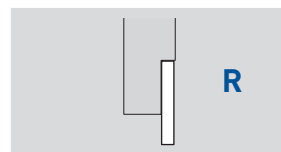
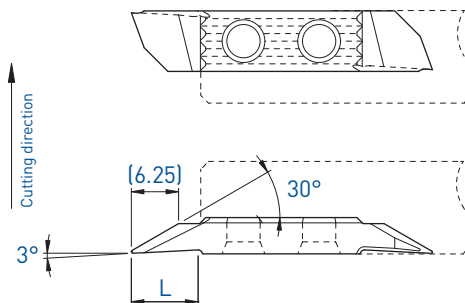
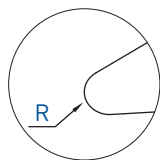
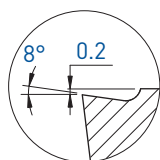

L	R	Art. N°	HTA	HTiN	HN [µk10]
9	0.15	762VX-800-R15	■	■	■

Tournage avant
Vorwärts drehen
Front turning

762VUX

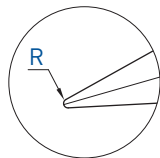
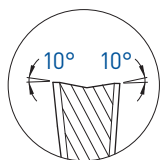

R

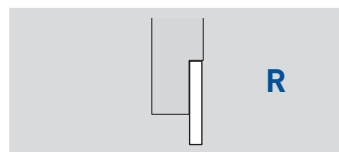
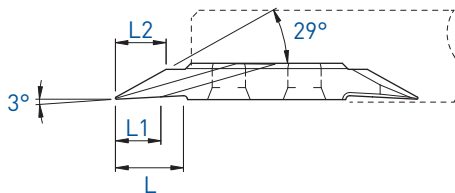
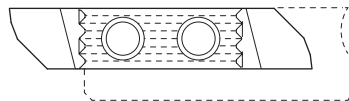

L	L1	L2	R	Art. N°	TiAlN N [µk20]	HTA	HN [µk10]
9	6	6.9	0.08	762VUX10-29°-R08	■ ■	■ ■	
9	6	6.7	0.15	762VUX10-29°-R15	■ ■	■ ■	
9	6	6.1	0.35	762VUX10-29°-R35	■ ■	■ ■	
9	6	4.9	0.75	762VUX10-29°-R75	■ ■	■ ■	

Tournage avant
Vorwärts drehen
Front turning

762ZX

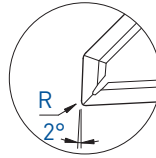
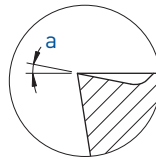

R

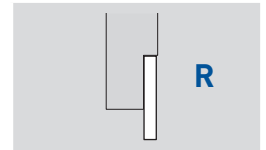
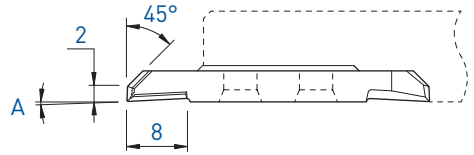
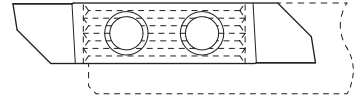

a	A	R	Art. N°	TiAIN	TiN	N (µk20)
10°	3°	0.08	762ZX10-R08	■	□	
	3°	0.20	762ZX10-R20	■	□	

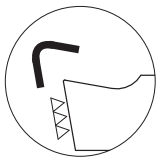

Arête de coupe honée
Gehonte Schneidkante
Honed edge

f min: 0.02 mm/U

7XX-XX-B

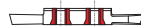

Sur demande pour serrage type B, voir page 1.03
Wahlweise mit B-Spannsystem, siehe Seite 1.03
On request for B clamping system, see page 1.03

TOP-LINE

Tournage multifonction
 Mehrzweck Drehen
 Multifunction turning

752S / 762S
 753S / 763S

L

R

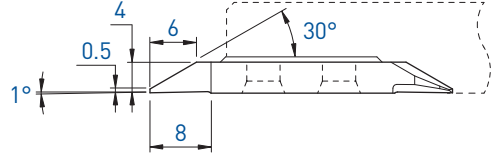
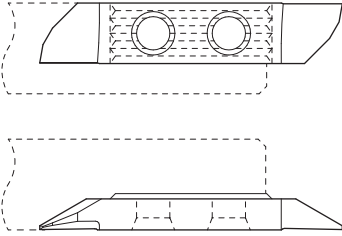

Tournage avant
 Vorwärts drehen
 Front turning

L						R								
Art. N°	TiAlN	TiN	N (µk20)	HTA	HTiN	HN (µk10)	Art. N°	TiAlN	TiAlX	TiN	N (µk20)	HTA	HTiN	HN (µk10)
752S05	■	■	■	■	□	■	762S05	■	■	■	■	■	■	■

L

R

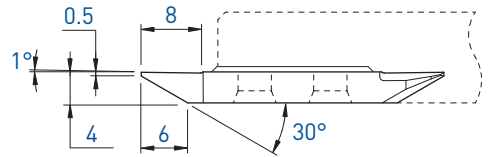
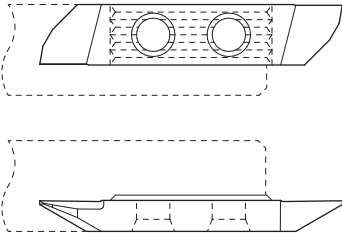

Tournage arrière
 Rückwärts drehen
 Back turning

L						R								
Art. N°	TiAlN	TiN	N (µk20)	HTA	HTiN	HN (µk10)	Art. N°	TiAlN	TiAlX	TiN	N (µk20)	HTA	HTiN	HN (µk10)
753S05	■	■	■	■	■	■	763S05	■	■	■	■	■	■	■

Tournage arrière
 Rückwärts drehen
 Back turning

753 / 763

L

R

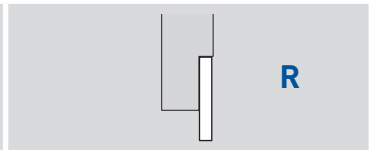
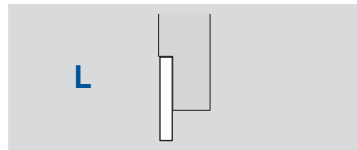
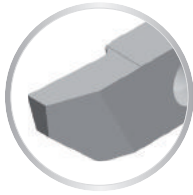
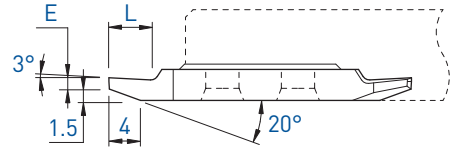
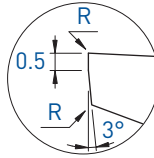
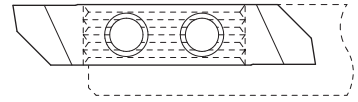
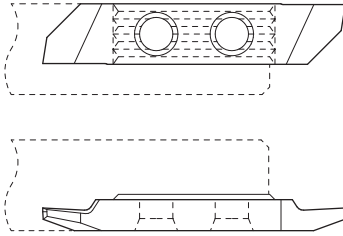

			L					R								
E	L	R	Art. N°	TiAlN	TiN	N (µk20)	HTA	HTiN	HN (µk10)	Art. N°	TiAlN	TiN	N (µk20)	HTA	HTiN	HN (µk10)
1.0	5	0	753-1.0	■	■	■	■	□	■	763-1.0	■	■	■	■	■	■
1.0	5	0.08	753-1.0-R08	■	■	■				763-1.0-R08	■	■	■	■	□	■
1.5	6	0	753-1.5	■	■	■				763-1.5	■	■	■	■	□	■
2.0	7.5	0	753-2.0	■	■	■				763-2.0	■	■	■	■	□	■
2.5	9	0	753-2.5	■	■	■				763-2.5	■	■	■	■	□	■

7XX-XX-B



Sur demande pour serrage type B, voir page 1.03
 Wahlweise mit B-Spannsystem, siehe Seite 1.03
 On request for B clamping system, see page 1.03

■ = disponible / verfügbar / available
 □ = selon disponibilité du stock / jenach Lagerverfügbarkeit / depending on stock availability

Tournage arrière
Rückwärts drehen
Back turning

753X / 763X

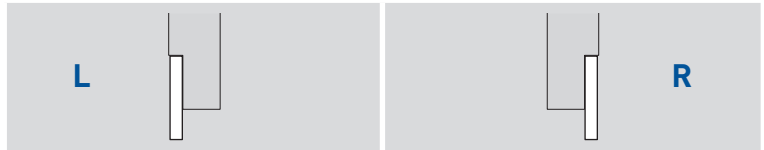
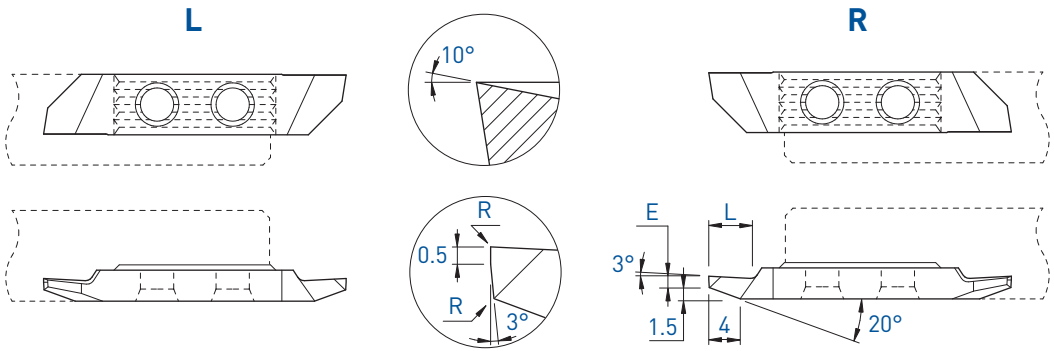

E	L	R	L				R									
			Art. N°	TiAlN	TiN	N (µk20)	HTA	HTiN	HN (µk10)	Art. N°	TiAlN	TiN	N (µk20)	HTA	HTiN	HN (µk10)
1.0	5	0	753X-1.0	■	■	■				763X-1.0	■	■	■	■	□	■
1.0	5	0.08	753X-1.0-R08	■	■	■	■	□	■	763X-1.0-R08	■	■	■	■	□	■
1.0	5	0.20	753X-1.0-R20	■	■	■				763X-1.0-R20	■	■	■			
1.5	6	0	753X-1.5	■	■	■				763X-1.5	■	■	■	■	□	■
1.5	6	0.20	753X-1.5-R20	■	■	■				763X-1.5-R20	■	■	■			
2.0	7.5	0	753X-2.0	■	■	■				763X-2.0	■	■	■			
2.0	7.5	0.20	753X-2.0-R20	■	■	■				763X-2.0-R20	■	■	■			
2.5	9	0	753X-2.5	■	■	■				763X-2.5	■	■	■			
2.5	9	0.20	753X-2.5-R20	■	■	■				763X-2.5-R20	■	■	■			

7XX-XX-B



Sur demande pour serrage type B, voir page 1.03
Wahlweise mit B-Spannsystem, siehe Seite 1.03
On request for B clamping system, see page 1.03

Tournage arrière
Rückwärts drehen
Back turning

753XS / 763XS

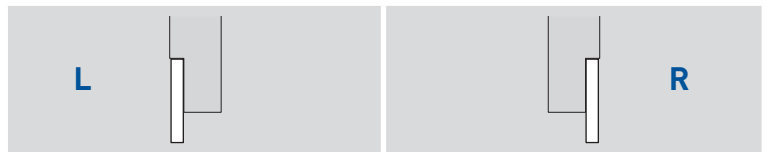
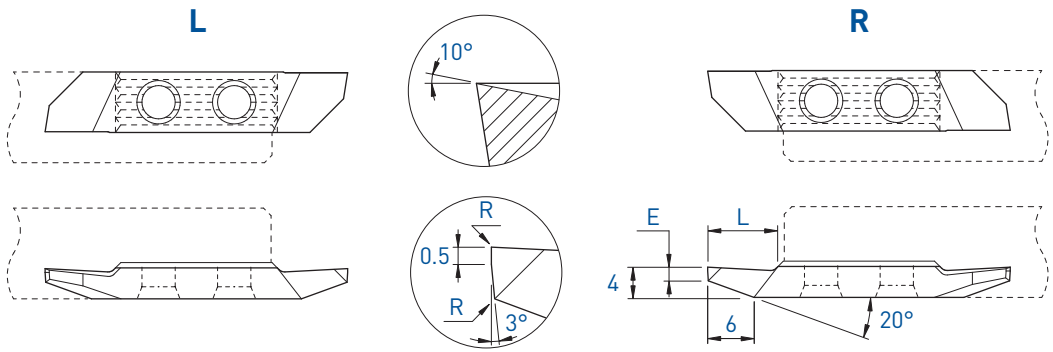

			L				R									
E	L	R	Art. N°	TiAlN	TiN	N (µk20)	HTA	HTiN	HN (µk10)	Art. N°	TiAlN	TiN	N (µk20)	HTA	HTiN	HN (µk10)
1.8	9	0	753XS-1.8	■	■	■				763XS-1.8	■	■	■	■	□	■
1.8	9	0.20	753XS-1.8-R20	■	■	■				763XS-1.8-R20	■	■	■			

7XX-XX-B

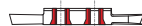

Sur demande pour serrage type B, voir page 1.03
Wahlweise mit B-Spannsystem, siehe Seite 1.03
On request for B clamping system, see page 1.03

■ = disponible / verfügbar / available
□ = selon disponibilité du stock / jenach Lagerverfügbarkeit / depending on stock availability

TOP-LINE

Tournage arrière
Rückwärts drehen
Back turning

753VX-8° / 763VX-8°

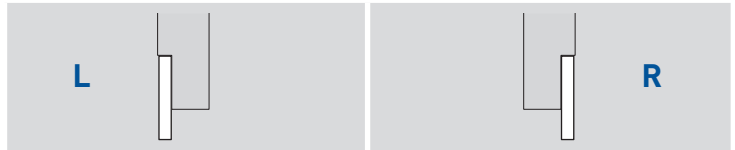
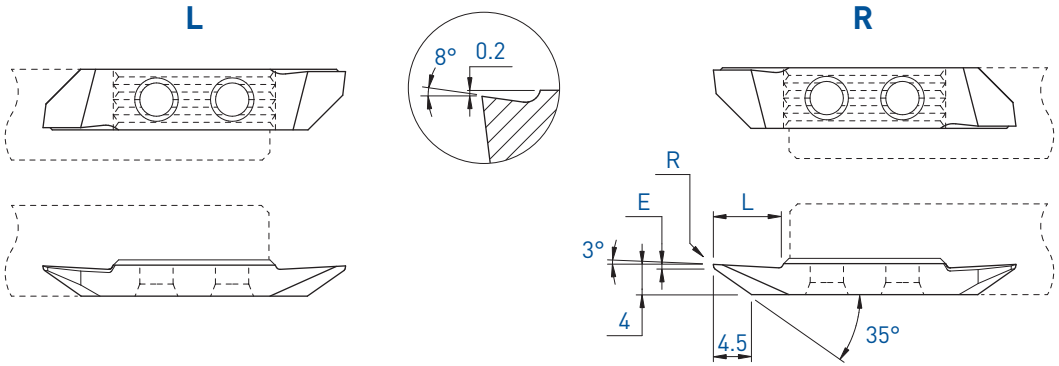

E	L	R	Art. N°	L			R									
				TiAlN	TiN	N (µk20)	HTA	HTiN	HN (µk10)	TiAlN	TiN	N (µk20)	HTA	HTiN	HN (µk10)	
1.0	9	0	753VX-8°	■	■	■				763VX-8°	■	■	■	■	■	■
1.0	9	0.08	753VX-8°-R08	■	■	■				763VX-8°-R08	■	■	■	■	□	■
1.0	9	0.20	-							763VX-8°-R20	■	■	■			



7XX-XX-B
Sur demande pour serrage type B, voir page 1.03
Wahlweise mit B-Spannsystem, siehe Seite 1.03
On request for B clamping system, see page 1.03

Tournage arrière
Rückwärts drehen
Back turning

753VX-805 / 763VX-805

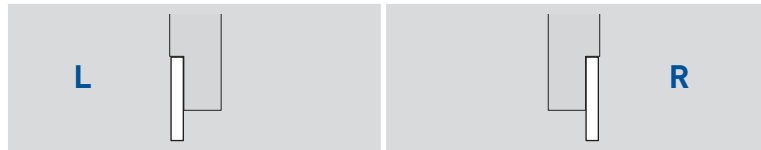
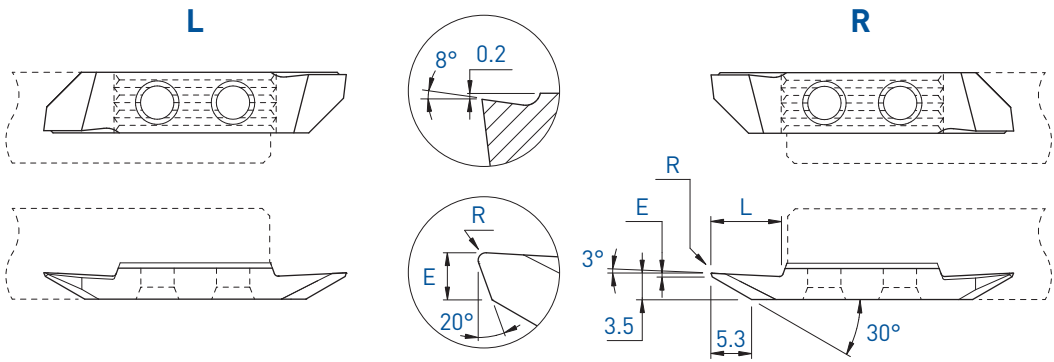

E	L	R	Art. N°	TiAlN	TiN	N (µk20)	HTA	HTiN	HN (µk10)	Art. N°	TiAlN	TiN	N (µk20)	HTA	HTiN	HN (µk10)
0.5	9	0.08	753VX-805-R08	■	■	■	■	□	■	763VX-805-R08	■	■	■	■	□	■

7XX-XX-B

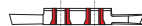

Sur demande pour serrage type B, voir page 1.03
Wahlweise mit B-Spannsystem, siehe Seite 1.03
On request for B clamping system, see page 1.03

■ = disponible / verfügbar / available
□ = selon disponibilité du stock / jenach Lagerverfügbarkeit / depending on stock availability

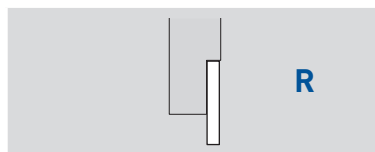
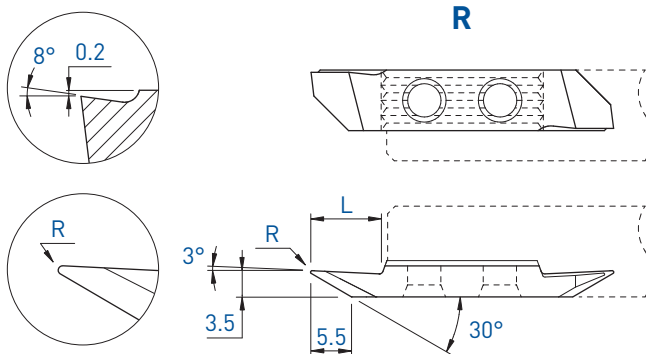

L	R	Art. N°	TiAlN	TiN	N (μk20)	HTA	HTiN	HN (μk10)
9	0.08	763VX-800-R08	■	■	■	■	□	■
9	0.20	763VX-800-R20	■	■	■	■	□	■

7XX-XX-B



Sur demande pour serrage type B, voir page 1.03
Wahlweise mit B-Spannsystem, siehe Seite 1.03
On request for B clamping system, see page 1.03

Tournage arrière
Rückwärts drehen
Back turning

753VX-15° / 763VX-15°

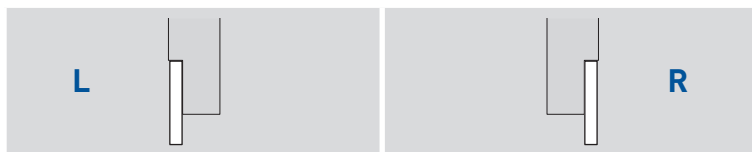
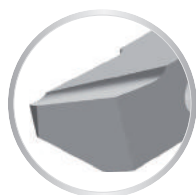
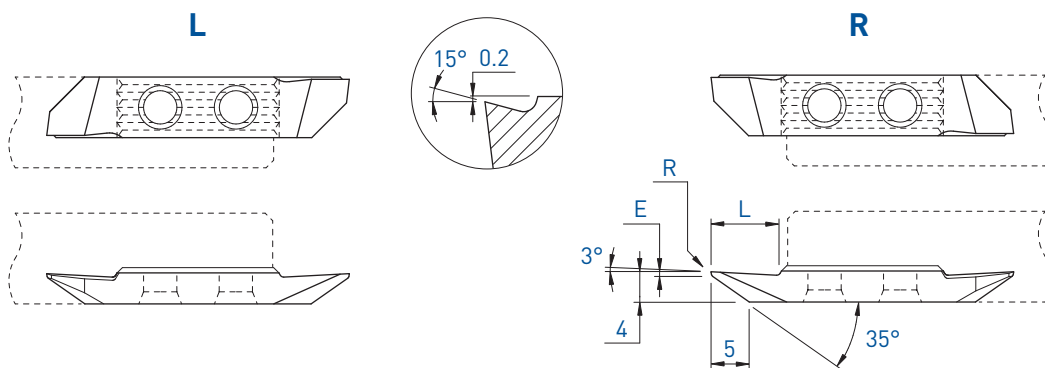

			L				R									
E	L	R	Art. N°	TiAlN	TiN	N (µk20)	HTA	HTiN	HN (µk10)	Art. N°	TiAlN	TiN	N (µk20)	HTA	HTiN	HN (µk10)
0.6	9	0	753VX-15°	■	■	■				763VX-15°	■	■	■	■	□	■
0.6	9	0.08	753VX-15°-R08	■	■	■				763VX-15°-R08	■	■	■	■	□	■

■ = disponible / verfügbar / available
□ = selon disponibilité du stock / jenach Lagerverfügbarkeit / depending on stock availability

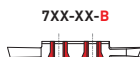

7XX-XX-B Sur demande pour serrage type B, voir page 1.03
Wahlweise mit B-Spannsystem, siehe Seite 1.03
On request for B clamping system, see page 1.03

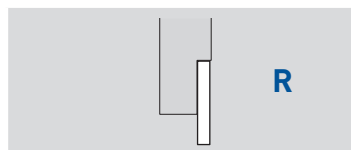
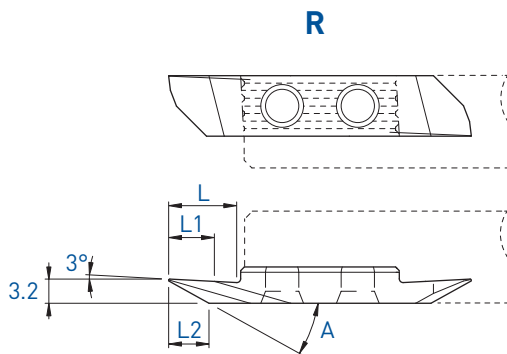
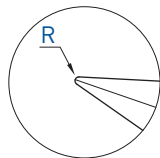
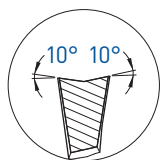

L	L1	L2	A	R	Art. N°	TiAlN	N [µk20]	HTA	HN [µk10]
9	6	5.5	29	0.08	763VUX10-29°-R08	■	■	■	■
9	6	5.3	29	0.15	763VUX10-29°-R15	■	■	■	■
9	6	4.7	29	0.35	763VUX10-29°-R35	■	■	■	■
9	6	3.6	29	0.75	763VUX10-29°-R75	■	■	■	■
9	6	4.2	35	0.15	763VUX10-35°-R15	■	■	■	■
9	6	3.8	35	0.35	763VUX10-35°-R35	■	■	■	■

7XX-XX-B



Sur demande pour serrage type B, voir page 1.03
Wahlweise mit B-Spannsystem, siehe Seite 1.03
On request for B clamping system, see page 1.03

Tournage arrière
Rückwärts drehen
Back turning

753ZX / 763ZX

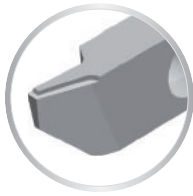
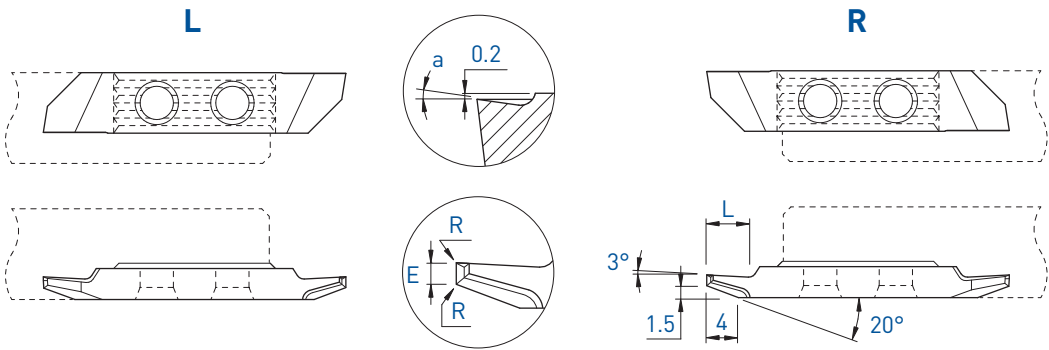

Pour un meilleur contrôle des copeaux
Für eine bessere Spankontrolle
For a better chip-control

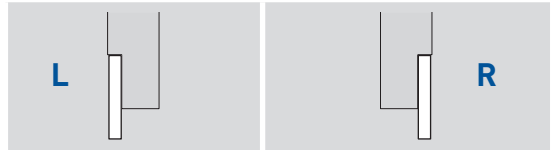

a	E	L	R	Art. N°	TiAIN	TiN	N (µk20)	Art. N°	TiAIN	TiN	N (µk20)
10°	1.0	5	0.01	753ZX10-1.0	■	□		763ZX10-1.0	■	■	
	1.0	5	0.08	-				763ZX10-1.0-R08	■	■	
	1.0	5	0.20	-				763ZX10-1.0-R20	■	■	



Arête de coupe honée
Gehonte Schneidkante
Honed edge

f min: 0.02 mm/U



7XX-XX-B

Sur demande pour serrage type B, voir page 1.03
Wahlweise mit B-Spannsystem, siehe Seite 1.03
On request for B clamping system, see page 1.03

TOP-LINE

Tournage arrière / pré-coupe
 Rückwärts drehen / vorstechen
 Back turning / pre-parting off

753P / 763P

L

R

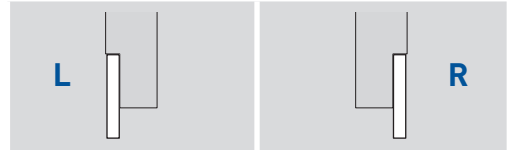
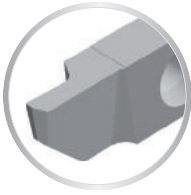
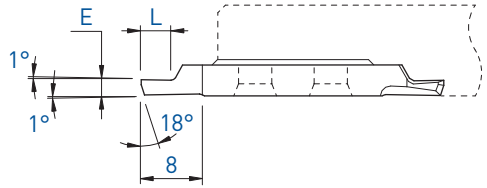
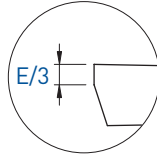
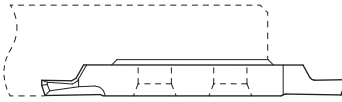
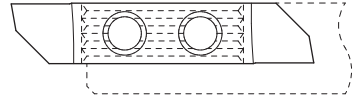
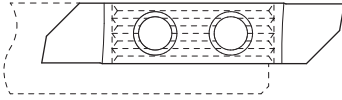

E	L	Art. N°	TiAlN	TiN	N (µk20)	Art. N°	TiAlN	TiN	N (µk20)
1.5	3	753P-1.5	■	■	■	763P-1.5	■	■	■
1.8	3.5	753P-1.8	■	■	■	763P-1.8	■	■	■
2.0	4	753P-2.0	■	■	■	763P-2.0	■	■	■
2.2	5	753P-2.2	■	■	■	763P-2.2	■	■	■
2.5	6	753P-2.5	■	■	■	763P-2.5	■	■	■
3.0	6	753P-3.0	■	■	■	763P-3.0	■	■	■

7XX-XX-B



Sur demande pour serrage type B, voir page 1.03
 Wahlweise mit B-Spannsystem, siehe Seite 1.03
 On request for B clamping system, see page 1.03

Fonçage-tournage

Einstecken und drehen

Grooving and turning

754 / 764

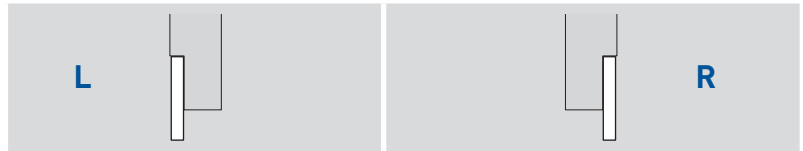
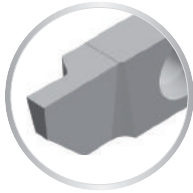
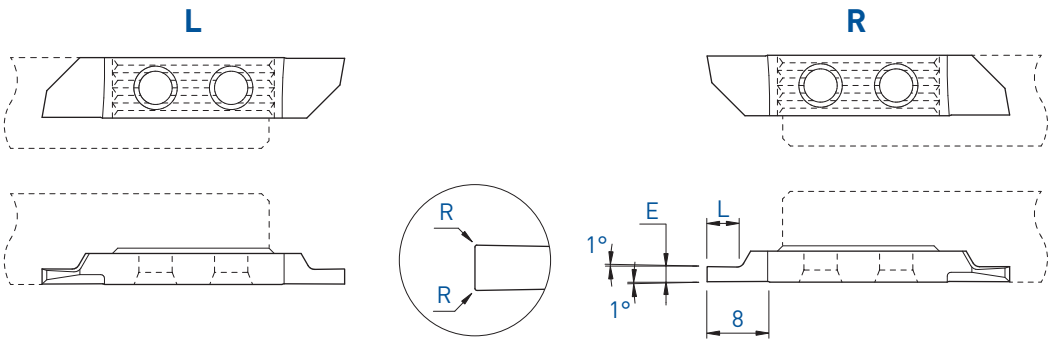

E	L	R	Art. N°	TiAlN	TiN	N (µk20)	HTA	HTiN	HN (µk10)	Art. N°	TiAlN	TiAlX	TiN	N (µk20)	HTA	HTiN	HN (µk10)
0.5	1.5	0	754-0.5	■	■	■				764-0.5	■	■	■	■	■	■	■
0.75	2	0	754-0.75	■	■	■				764-0.75	■	■	■	■	■	■	■
0.8	2	0	-							764-0.8	■	■	■	■	■	□	■
0.95	3	0	754-0.95	■	■	■	■	□	■	764-0.95	■	■	■	■	■	■	■
1.0	2.5	0	754-1.0	■	■	■	■	□	■	764-1.0	■	■	■	■	■	■	■
1.0	2.5	0.08	754-1.0-R08	■	■	■	■	□	■	764-1.0-R08	■	■	■	■	■	□	■
1.2	3	0	754-1.2	■	■	■	■			764-1.2	■	■	■	■	■	□	■
1.5	3	0	754-1.5	■	■	■	■	□	■	764-1.5	■	■	■	■	■	■	■
1.5	3	0.08	754-1.5-R08	■	■	■	■	□	■	764-1.5-R08	■	■	■	■	■	□	■
1.5	3	0.15	-							764-1.5-R15	■	■	□	■	■	■	■
1.5	3	0.20	-							764-1.5-R20	■	■	■	■	■	□	■
1.8	4	0	754-1.8	■	■	■	■			764-1.8	■	■	■	■	■	■	■
2.0	4	0	754-2.0	■	■	■	■	□	■	764-2.0	■	■	■	■	■	■	■
2.0	4	0.08	754-2.0-R08	■	■	■	■	□	■	764-2.0-R08	■	■	■	■	■	□	■
2.0	4	0.15	-							764-2.0-R15	■	■	□	■	■	■	■
2.0	4	0.20	754-2.0-R20	■	■	■	■			764-2.0-R20	■	■	■	■	■	■	■
2.5	6	0	754-2.5	■	■	■	■			764-2.5	■	■	■	■	■	□	■
2.5	6	0.15	-							764-2.5-R15	■	■	□	■	■	■	■
2.5	6	0.20	-							764-2.5-R20	■	■	■	■	■	□	■
3.0	6	0	754-3.0	■	■	■	■	□	■	764-3.0	■	■	■	■	■	□	■
3.0	6	0.08	754-3.0-R08	■	■	■	■			764-3.0-R08	■	■	■	■	■	□	■
3.0	6	0.15	-							764-3.0-R15	■	■	□	■	■	■	■
3.0	6	0.20	754-3.0-R20	■	■	■	■	□	■	764-3.0-R20	■	■	■	■	■	■	■
4.0	8	0	754-4.0	■	■	■	■	■	■	764-4.0	■	■	■	■	■	□	■

7XX-XX-B



Sur demande pour serrage type B, voir page 1.03
Wahlweise mit B-Spannsystem, siehe Seite 1.03
On request for B clamping system, see page 1.03

■ = disponible / verfügbar / available
□ = selon disponibilité du stock / jenach Lagerverfügbarkeit / depending on stock availability

TOP-LINE

Fonçage-tournage
Einstecken und drehen
Grooving and turning

754VS / 764VS

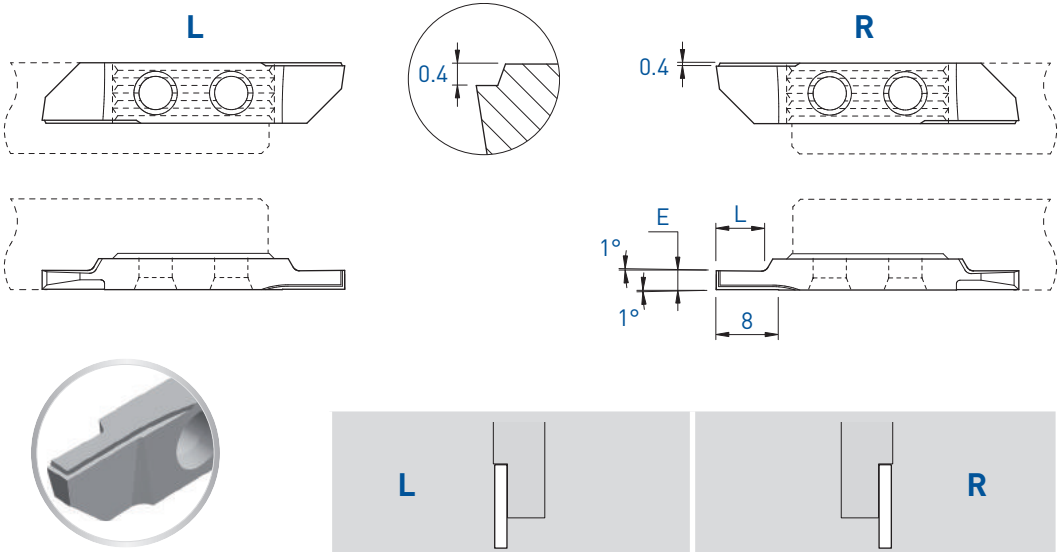

		L						R							
E	L	Art. N°	TiAlN	TiN	N (µk20)	HTA	HTiN	HN (µk10)	Art. N°	TiAlN	TiN	N (µk20)	HTA	HTiN	HN (µk10)
1.0	2	754VS-1.0	■	■	■				764VS-1.0	■	■	■			
1.2	2.5	754VS-1.2	■	■	■		□	■	764VS-1.2	■	■	■			
1.5	3	754VS-1.5	■	■	■				764VS-1.5	■	■	■			
2.0	4	754VS-2.0	■	■	■				764VS-2.0	■	■	■			
2.5	6	754VS-2.5	■	■	■				764VS-2.5	■	■	■	■	□	■
3.0	6	754VS-3.0	■	■	■				764VS-3.0	■	■	■			

7XX-XX-B



Sur demande pour serrage type B, voir page 1.03
Wahlweise mit B-Spannsystem, siehe Seite 1.03
On request for B clamping system, see page 1.03

Fonçage-tournage

Einstecken und drehen

Grooving and turning

754X / 764X

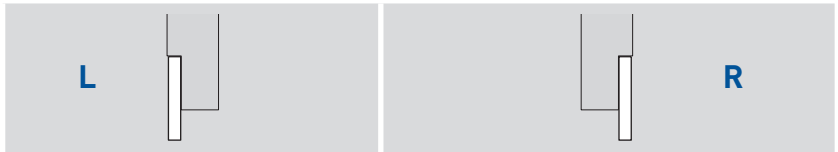
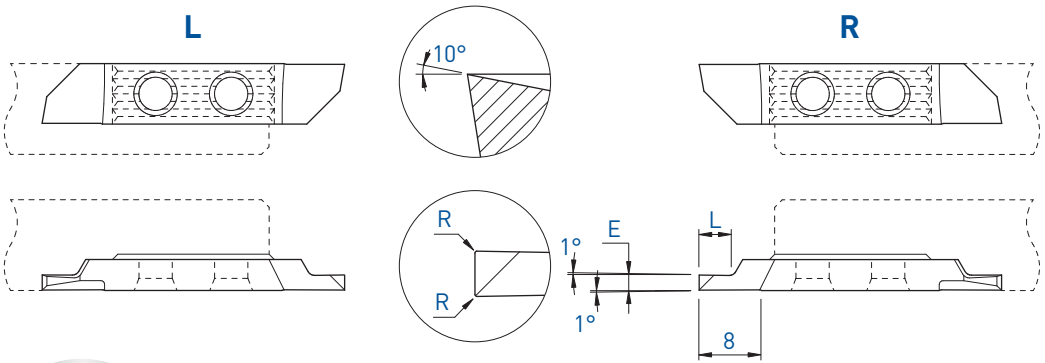

E	L	R	Art. N°	TiAlN	TiN	N (µk20)	HTA	HTiN	HN (µk10)	Art. N°	TiAlN	TiAlX	LoX	TiN	N (µk20)	HTA	HTiN	HN (µk10)
1.0	2.5	0	754X-1.0	■	■	■	■	■	■	764X-1.0	■	■	■	■	■	■	□	■
1.0	2.5	0.08	754X-1.0-R08	■	■	■	■	□	■	764X-1.0-R08	■	■	■	■	■	■	□	■
1.0	2.5	0.20	-							764X-1.0-R20	■	■	■	■	■			
1.2	3	0	754X-1.2	■	■	■				764X-1.2	■	■	■	■	■		□	■
1.2	3	0.08	-							764X-1.2-R08	■	■	■	■	■			
1.5	3	0	754X-1.5	■	■	■	■	□	■	764X-1.5	■	■	■	■	■		■	■
1.5	3	0.08	754X-1.5-R08	■	■	■	■	□	■	764X-1.5-R08	■	■	■	■	■		□	■
1.5	3	0.15	-							764X-1.5-R15	■	■	■	□	■			■
1.5	3	0.20	754X-1.5-R20	■	■	■	■			764X-1.5-R20	■	■	■	■	■		■	■
1.8	4	0	754X-1.8	■	■	■				764X-1.8	■	■	■	■	■		□	■
1.8	4	0.20	-							764X-1.8-R20	■	■	■	■	■			
2.0	4	0	754X-2.0	■	■	■	■	□	■	764X-2.0	■	■	■	■	■		■	■
2.0	4	0.08	754X-2.0-R08	■	■	■	■	□	■	764X-2.0-R08	■	■	■	■	■		□	■
2.0	4	0.15	-							764X-2.0-R15	■	■	■	□	■			■
2.0	4	0.20	754X-2.0-R20	■	■	■	■	□	■	764X-2.0-R20	■	■	■	■	■		□	■
2.0	4	0.35	-							764X-2.0-R35	■	■	■	□	■			■
2.5	6	0	754X-2.5	■	■	■	■	■	■	764X-2.5	■	■	■	■	■		■	■
2.5	6	0.15	-							764X-2.5-R15	■	■	■	□	■			■
2.5	6	0.20	754X-2.5-R20	■	■	■	■	□	■	764X-2.5-R20	■	■	■	■	■		□	■
2.5	6	0.35	-							764X-2.5-R35	■	■	■	□	■			■
3.0	6	0	754X-3.0	■	■	■				764X-3.0	■	■	■	■	■		□	■
3.0	6	0.08	754X-3.0-R08	■	■	■				764X-3.0-R08	■	■	■	■	■		□	■
3.0	6	0.15	-							764X-3.0-R15	■	■	■	□	■			■
3.0	6	0.20	754X-3.0-R20	■	■	■				764X-3.0-R20	■	■	■	■	■		□	■
3.0	6	0.35	-							764X-3.0-R35	■	■	■	□	■			■
4.0	8	0	754X-4.0	■	■	■				764X-4.0	■	■	■	■	■		□	■
4.0	8	0.20	754X-4.0-R20	■	■	■				764X-4.0-R20	■	■	■	■	■		□	■
4.0	8	0.35	-							764X-4.0-R35	■	■	■	□	■			■

■ = disponible / verfügbar / available
 □ = selon disponibilité du stock / jenach Lagerverfügbarkeit / depending on stock availability



Sur demande pour serrage type B, voir page 1.03
 Wahlweise mit B-Spannsystem, siehe Seite 1.03
 On request for B clamping system, see page 1.03

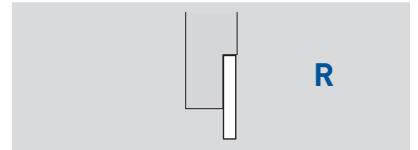
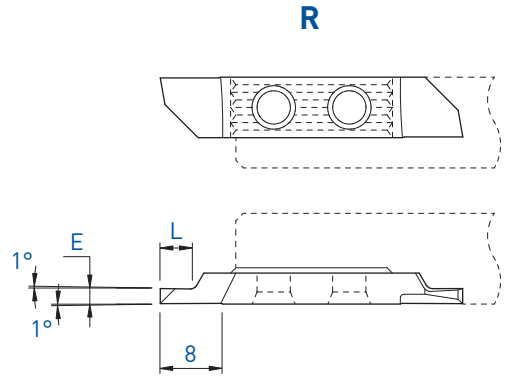
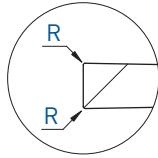
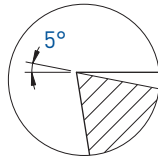

E	L	R	Art. N°	TiAlN	TiAlX	LoX	TiN	N (µm20)
1.5	3	0.08	764X5-1.5-R08-EP	■	■	■	■	■
2.0	4	0.08	764X5-2.0-R08-EP	■	■	■	■	■
2.5	6	0.08	764X5-2.5-R08-EP	■	■	■	■	■
2.5	6	0.15	764X5-2.5-R15-EP	■	■	■	■	■
3.0	6	0.08	764X5-3.0-R08-EP	■	■	■	■	■
3.0	6	0.15	764X5-3.0-R15-EP	■	■	■	■	■
4.0	8	0.15	764X5-4.0-R15-EP	■	■	■	■	■
4.0	8	0.35	764X5-4.0-R35-EP	■	■	■	■	■

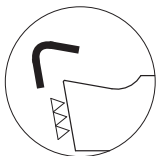

Arête de coupe honée
Gehonte Schneidkante
Honed edge



7XX-XX-B
Sur demande pour serrage type B, voir page 1.03
Wahlweise mit B-Spannsystem, siehe Seite 1.03
On request for B clamping system, see page 1.03

Fonçage-tournage

Einstecken und drehen

Grooving and turning

764X10-EP

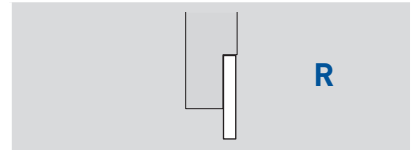
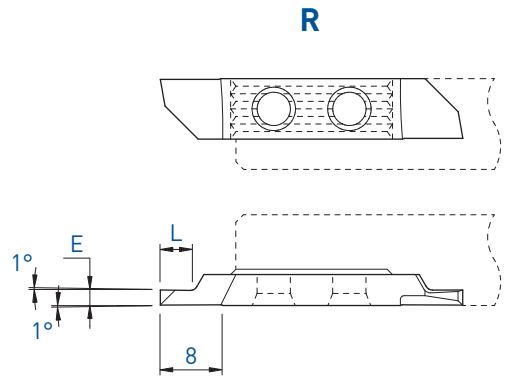
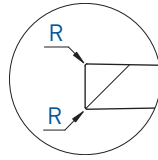
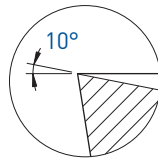

E	L	R	Art. N°	TiAIN	TiAlX	LoX	TiN	N (µm20)
1.5	3	0.08	764X10-1.5-R08-EP	■	■	■	■	■
2.0	4	0.08	764X10-2.0-R08-EP	■	■	■	■	■
2.5	6	0.08	764X10-2.5-R08-EP	■	■	■	■	■
2.5	6	0.15	764X10-2.5-R15-EP	■	■	■	■	■
3.0	6	0.08	764X10-3.0-R08-EP	■	■	■	■	■
3.0	6	0.15	764X10-3.0-R15-EP	■	■	■	■	■
4.0	8	0.15	764X10-4.0-R15-EP	■	■	■	■	■
4.0	8	0.35	764X10-4.0-R35-EP	■	■	■	■	■

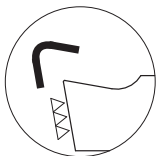

Arête de coupe honée
Gehonte Schneidkante
Honed edge



7XX-XX-B
Sur demande pour serrage type B, voir page 1.03
Wahlweise mit B-Spannsystem, siehe Seite 1.03
On request for B clamping system, see page 1.03

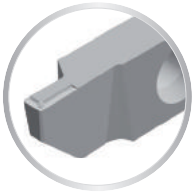
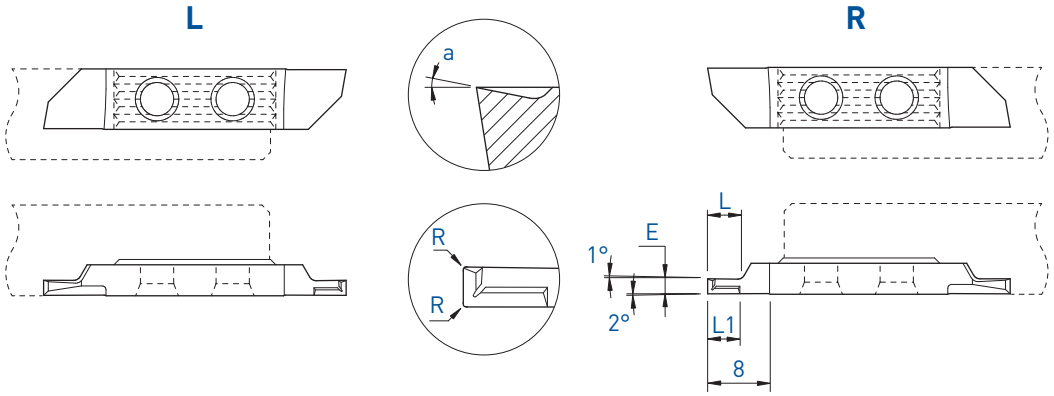

Pour un meilleur contrôle des copeaux
Für eine bessere Spankontrolle
For a better chip-control



a	E	L	L1	R	Art. N°	TiAlN				Art. N°	TiAlN					
						Ti	Al	N	HN (µk10)		Ti	Al	N	HN (µk10)		
10°	1.5	4	4	0.03	754ZX10-1.5-R03	■	□			764ZX10-1.5-R03	■	■	■			
	1.5	4	4	0.08	754ZX10-1.5-R08	■	□			764ZX10-1.5-R08	■	■	■			
	2.0	4	4	0.08	754ZX10-2.0-R08	■	□			764ZX10-2.0-R08	■	■	■			
	2.0	4	4	0.20	-					764ZX10-2.0-R20	■	■	□			
	2.5	5	5	0.08	754ZX10-2.5-R08	■	■			764ZX10-2.5-R08	■	■	■			
	2.5	5	5	0.20	-					764ZX10-2.5-R20	■	■	■			
	3.0	6	6	0.08	754ZX10-3.0-R08	■	□			764ZX10-3.0-R08	■	■	■			
	3.0	6	6	0.20	-					764ZX10-3.0-R20	■	■	■			
25°	4.0	6	6	0.20	-					764ZX10-4.0-R20	■	■	□			
	2.0	4	4	0.08	-					764ZX25-2.0-R08				■	■	□
	2.0	4	4	0.20	-					764ZX25-2.0-R20				■	■	□
	2.5	5	5	0.08	-					764ZX25-2.5-R08				■	■	□
2.5	5	5	0.20	-					764ZX25-2.5-R20				■	■	□	

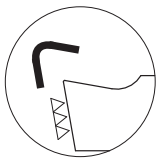

Arête de coupe honée
Gehonte Schneidkante
Honed edge

f min: 0.02 mm/U



7XX-XX-B

Sur demande pour serrage type B, voir page 1.03
Wahlweise mit B-Spannsystem, siehe Seite 1.03
On request for B clamping system, see page 1.03

Fonçage-tournage

Einstecken und drehen

Grooving and turning

764ZXB

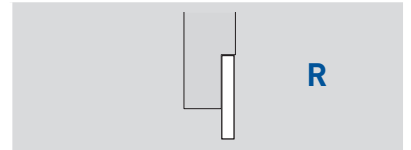
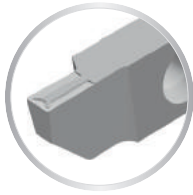
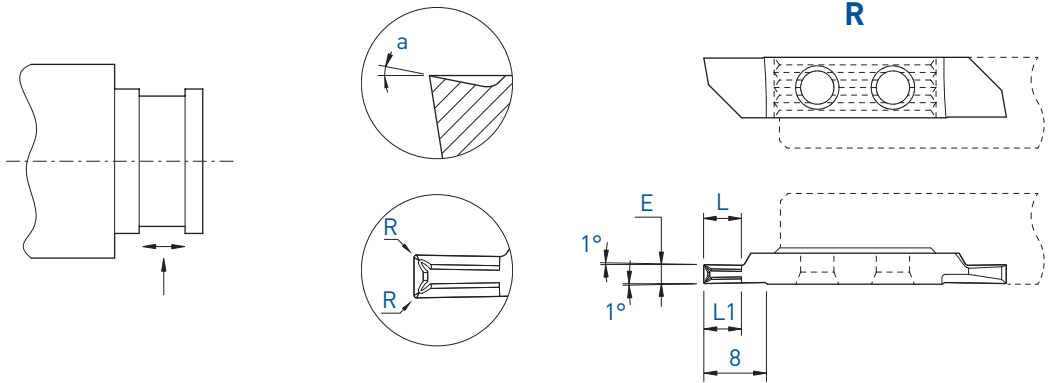

a	E	L	L1	R	Art. N°	TiAIN	TiAlX	LoX	TiN	N (µm20)
10°	1.5	4	4	0.08	764ZXB10-1.5-R08	■	■	■	□	
	2.0	4	4	0.08	764ZXB10-2.0-R08	■	■	■	□	
	2.0	4	4	0.15	764ZXB10-2.0-R15	■	■	■	□	
	2.0	4	4	0.35	764ZXB10-2.0-R35	■	■	■	□	
	2.5	5	5	0.08	764ZXB10-2.5-R08	■	■	■	□	
	2.5	5	5	0.15	764ZXB10-2.5-R15	■	■	■	□	
	2.5	5	5	0.35	764ZXB10-2.5-R35	■	■	■	□	
	3.0	6	6	0.08	764ZXB10-3.0-R08	■	■	■	□	
	3.0	6	6	0.15	764ZXB10-3.0-R15	■	■	■	□	
	3.0	6	6	0.35	764ZXB10-3.0-R35	■	■	■	□	

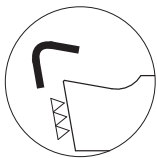

Arête de coupe honée
Gehonte Schneidkante
Honed edge

f min: 0.02 mm/U



7XX-XX-B

Sur demande pour serrage type B, voir page 1.03
Wahlweise mit B-Spannsystem, siehe Seite 1.03
On request for B clamping system, see page 1.03

■ = disponible / verfügbar / available
□ = selon disponibilité du stock / jenach Lagerverfügbarkeit / depending on stock availability

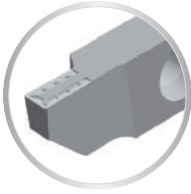
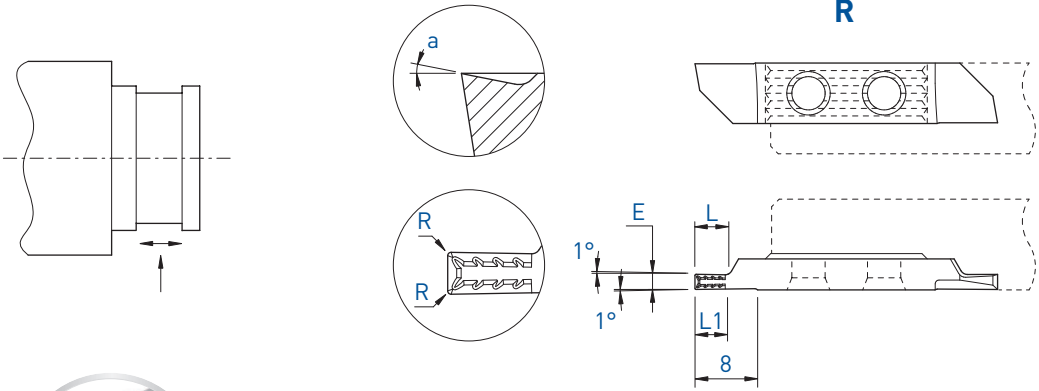

Pour un meilleur contrôle des copeaux
Für eine bessere Spankontrolle
For a better chip-control

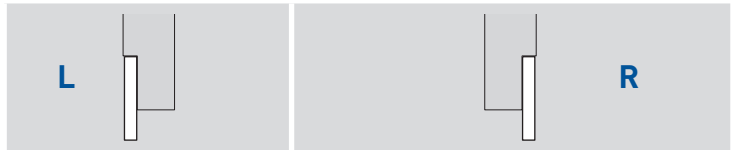

a	E	L	L1	R	Art. N°	L			R				HTA	HN (µk10)	
						TiAlN	TiN	N (µk20)	TiAlN	TiAlX	LOX	TiN			N (µk20)
10°	1.5	4	4	0.03	-				764ZXT10-1.5-R03	■	■	■	□		
	1.5	4	4	0.08	754ZXT10-1.5-R08	■	□		764ZXT10-1.5-R08	■	■	■	□		
	1.5	4	4	0.20	754ZXT10-1.5-R20	■			-						
	2.0	4	4	0.08	754ZXT10-2.0-R08	■	□		764ZXT10-2.0-R08	■	■	■	□		
	2.0	4	4	0.20	754ZXT10-2.0-R20	■			764ZXT10-2.0-R20	■	■	■	□		
	2.0	4	4	0.40	-				764ZXT10-2.0-R40	■	■	■			
	2.5	5	5	0.08	754ZXT10-2.5-R08	■	□		764ZXT10-2.5-R08	■	■	■	□		
	2.5	5	5	0.20	754ZXT10-2.5-R20	■			764ZXT10-2.5-R20	■	■	■	□		
	2.5	5	5	0.40	-				764ZXT10-2.5-R40	■	■	■			
	3.0	6	6	0.08	754ZXT10-3.0-R08	■	□		764ZXT10-3.0-R08	■	■	■	□		
	3.0	6	6	0.20	-				764ZXT10-3.0-R20	■	■	■	□	■	
	3.0	6	6	0.40	-				764ZXT10-3.0-R40	■	■	■	□		
	4.0	8	8	0.20	-				764ZXT10-4.0-R20	■	■	■	□		
	4.0	8	8	0.40	-				764ZXT10-4.0-R40	■	■	■	□		
4.0	8	8	0.80	-				764ZXT10-4.0-R80	■	■	■				

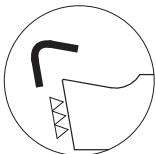

Arête de coupe honée
Gehonte Schneidkante
Honed edge

f min: 0.02 mm/U



7XX-XX-B
Sur demande pour serrage type B, voir page 1.03
Wahlweise mit B-Spannsystem, siehe Seite 1.03
On request for B clamping system, see page 1.03

Filetage

Gewinde drehen

Threading

756 / 766

L

R

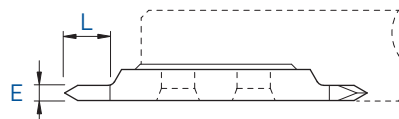
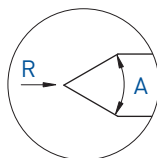
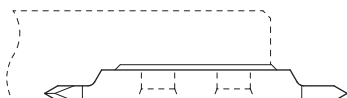
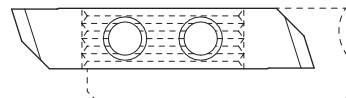
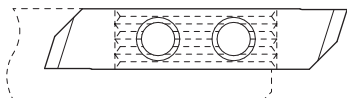

L



R



A	E	L	R	Art. N°	TiAlN	TiN	N (µk20)	HTA	HTiN	HN (µk10)	Art. N°	TiAlN	TiN	N (µk20)	HTA	HTiN	HN (µk10)
60°	2.0	6	-	756-60-2.0	■	■	■				766-60-2.0	■	■	■			
60°	2.0	6	0.02	756-60-2.0-R02	■	■	■	■	□	■	766-60-2.0-R02	■	■	■	■	□	■
60°	3.0	8	-	756-60-3.0	■	■	■				766-60-3.0	■	■	■			
60°	3.0	8	0.02	756-60-3.0-R02	■	■	■	■	□	■	766-60-3.0-R02	■	■	■	■	□	■
55°	2.0	6	-	756-55-2.0	■	■	■				766-55-2.0	■	■	■			
55°	2.0	6	0.02	756-55-2.0-R02	■	■	■				766-55-2.0-R02	■	■	■			
55°	3.0	8	-	756-55-3.0	■	■	■				766-55-3.0	■	■	■			
55°	3.0	8	0.02	756-55-3.0-R02	■	■	■				766-55-3.0-R02	■	■	■			

7XX-XX-B



Sur demande pour serrage type B, voir page 1.03
Wahlweise mit B-Spannsystem, siehe Seite 1.03
On request for B clamping system, see page 1.03

■ = disponible / verfügbar / available
□ = selon disponibilité du stock / jenach Lagerverfügbarkeit / depending on stock availability

- Filetage
- Gewinde drehen
- Threading

756-AG60° / 766-AG60°
756-G60° / 766-G60°

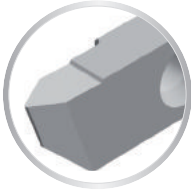
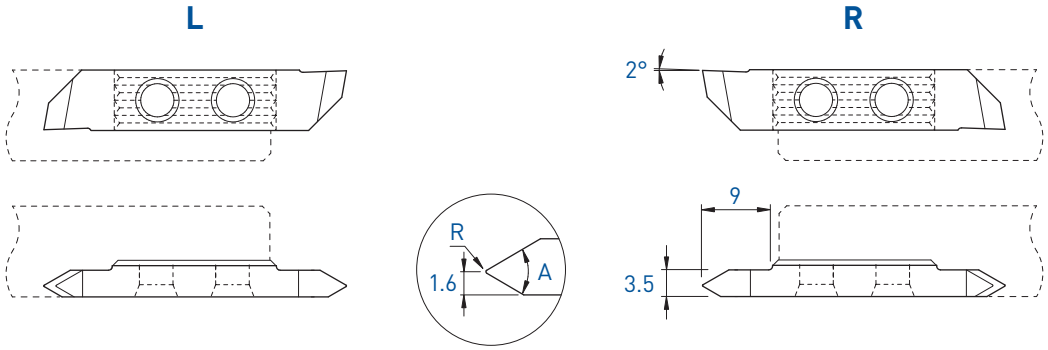

Profil partiel
Teilprofil
Partial profile



			L			R				
A	R	Pas Steigung Pitch P	Art. N°	TiAIN	TiN	N (µk20)	Art. N°	TiAIN	TiN	N (µk20)
60°	0.06	0.50-1.50	756-AG60°	■	■	■	766-AG60°	■	■	■
60°	0.20	1.75-3.00	756-G60°	■	■	■	766-G60°	■	■	■

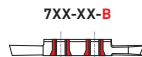

7XX-XX-B
Sur demande pour serrage type B, voir page 1.03
Wahlweise mit B-Spannsystem, siehe Seite 1.03
On request for B clamping system, see page 1.03

Filetage

Gewinde drehen

Threading

756-M / 766-M

L

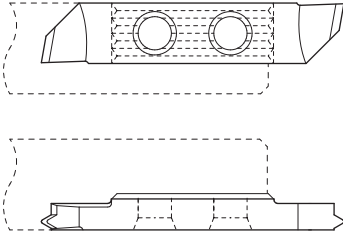

R

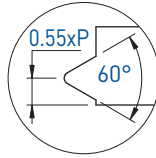
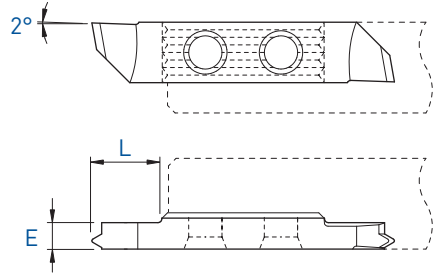

Profil complet métrique
Metrisches Vollprofil
Metric full profile

L

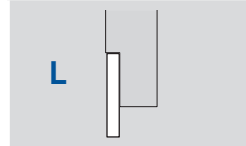

R

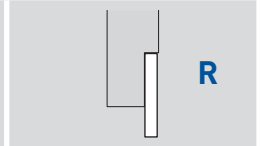

E	L	Pas Steigung Pitch P	L			R				
			Art. N°	TiAIN	TiN	N (µk20)	Art. N°	TiAIN	TiN	N (µk20)
2.5	8	0.80	756-M-0.80	■	■	■	766-M-0.80	■	■	■
2.5	8	1.00	756-M-1.00	■	■	■	766-M-1.00	■	■	■
2.5	8	1.25	756-M-1.25	■	■	■	766-M-1.25	■	■	■
3.5	9	1.50	756-M-1.50	■	■	■	766-M-1.50	■	■	■
3.5	9	1.75	756-M-1.75	■	■	■	766-M-1.75	■	■	■
3.5	9	2.00	756-M-2.00	■	■	■	766-M-2.00	■	■	■

Pour de plus petits pas, voir page 1.65
Für kleinere Steigungen, siehe Seite 1.65
For smaller pitches, see page 1.65

7XX-XX-B

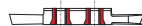

Sur demande pour serrage type B, voir page 1.03
Wahlweise mit B-Spannsystem, siehe Seite 1.03
On request for B clamping system, see page 1.03

■ = disponible / verfügbar / available
□ = selon disponibilité du stock / jenach Lagerverfügbarkeit / depending on stock availability

new

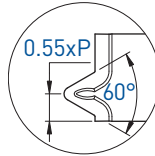
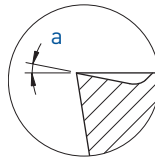

R

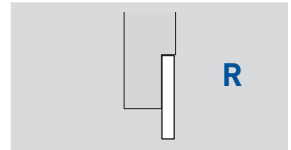
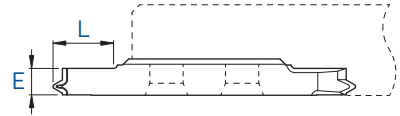
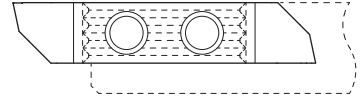

a	E	L	P	Art. N°	TiAIN	LOX
10°	2.5	8	0.80	766ZX10-M-0.80	■	□
	2.5	8	1.00	766ZX10-M-1.00	■	□
	2.5	8	1.25	766ZX10-M-1.25	■	□
	3.5	9	1.50	766ZX10-M-1.50	■	□
	3.5	9	1.75	766ZX10-M-1.75	■	□
	3.5	9	2.00	766ZX10-M-2.00	■	□

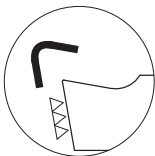

Arête de coupe honée
Gehonte Schneidkante
Honed edge

7XX-XX-B

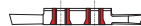

Sur demande pour serrage type B, voir page 1.03
Wahlweise mit B-Spannsystem, siehe Seite 1.03
On request for B clamping system, see page 1.03

Plaquettes à rayon
 Radius Wendeplatten
 Radius inserts

757 / 767

L

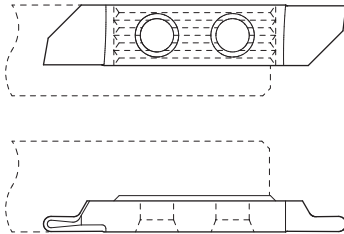

R

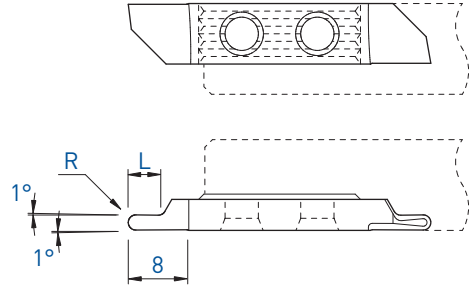

R	L	Art. N°	TiAlN			Art. N°	TiN		
			Ti	Al	N		Ti	Al	N
0.5	2.5	757-R0.5	■	■	■	767-R0.5	■	■	■
1.0	4	757-R1.0	■	■	■	767-R1.0	■	■	■
1.5	6	757-R1.5	■	■	■	767-R1.5	■	■	■
2.0	8	757-R2.0	■	■	■	767-R2.0	■	■	■

7XX-XX-B



Sur demande pour serrage type B, voir page 1.03
 Wahlweise mit B-Spannsystem, siehe Seite 1.03
 On request for B clamping system, see page 1.03

■ = disponible / verfügbar / available
 □ = selon disponibilité du stock / jenach Lagerverfügbarkeit / depending on stock availability

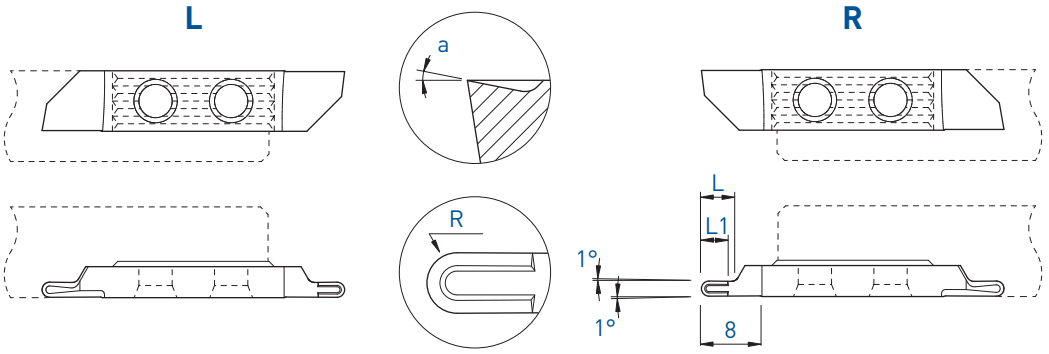

Pour un meilleur contrôle des copeaux
 Für eine bessere Spankontrolle
 For a better chip-control



a	R	L	L1	Art. N°	L			Art. N°	R			
					TiAlN	TiN	N (µk20)		TiAlN	TiN	N (µk20)	HTA
10°	1.0	4	3.5	757ZX10-R1.0	■	□		767ZX10-R1.0	■	□		
	1.5	6	4.0	757ZX10-R1.5	■	□		767ZX10-R1.5	■	□		
	2.0	8	4.5	757ZX10-R2.0	■	□		767ZX10-R2.0	■	□	■	

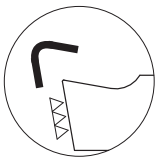

Arête de coupe honée
 Gehonte Schneidkante
 Honed edge

f min: 0.02 mm/U



7XX-XX-B

Sur demande pour serrage type B, voir page 1.03
 Wahlweise mit B-Spannsystem, siehe Seite 1.03
 On request for B clamping system, see page 1.03

Plaquettes ébauches
WSP-Rohlinge
Blank inserts

751-E / 761-E
751-EP / 761-EP

L

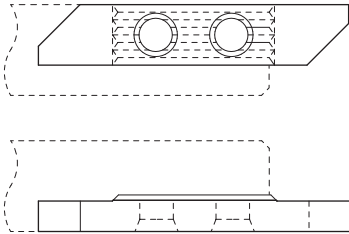

R

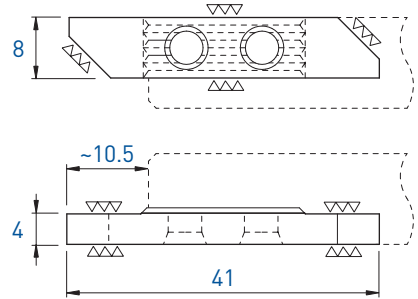

7XX-XX-B



Sur demande pour serrage type B, voir page 1.03
Wahlweise mit B-Spannsystem, siehe Seite 1.03
On request for B clamping system, see page 1.03

L

R

Art. N°	N (µk20)	HN (µk10)	Art. N°	N (µk20)	HN (µk10)
751-E	■	■	761-E	■	■

L

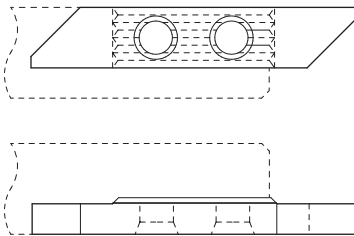

R

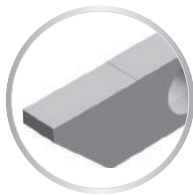
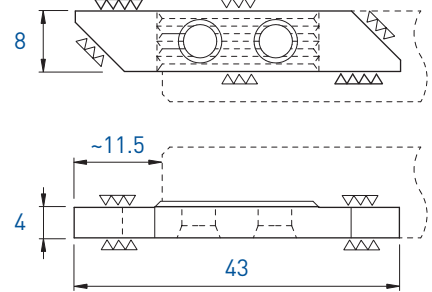

Face de coupe polie
Polierte Schneidfläche
Polished cutting face

L

R

Art. N°	TiAlN	TiN	N (µk20)	HTA	HTiN	HN (µk10)	Art. N°	TiAlN	TiN	N (µk20)	HTA	HTiN	HN (µk10)
751-EP	■	■	■	□	□	■	761-EP	■	■	■	■	□	■

770 / 780
7050 / 7060
W750 / W760

Porte-outils spécifiques
Spezifische Werkzeughalter
Specific tool holders

770 / 780

Tronçonnage de grande capacité
Abstechen für grössere Durchmesser
High capacity parting

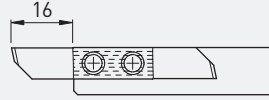

> **1.133**

7050 / 7060

Tronçonnage de grande capacité
Abstechen für grössere Durchmesser
High capacity parting

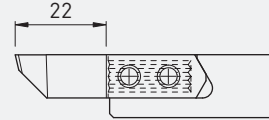

> **1.143**

W750 / W760

Outils avec plaquettes ébauchées larges pour profilage
Werkzeuge mit breiten WSP-Rohlingen für Profilschleifen
Tools with wide blank inserts for profiling

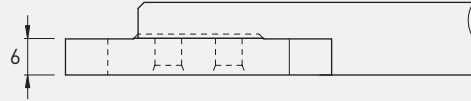

> **1.149**

Porte-outils spécifiques / Spezifische Werkzeughalter / Specific tool holders

POLYGONAL INTERFACE C3 / C4 / HSK

> **1.153**

740Z / 760Z

Porte-outils pour usinage déporté
Halter für versetzte Bearbeitung
Holders for shifted machining

> **1.156**

DECO 7/10 - EvoDECO 10

R

> **1.157**

DECO 7/10 - EvoDECO 10

L

> **1.159**

Tornos

**DECO 13 - EvoDECO 16
DECO 20/26 - EvoDECO 20/32**

> **1.161**

MultiSwiss 6x16

> **1.163**

AS14 / SAS16

> **1.164**

Schütte

> **1.165**

Porte-outils

Halter

Holders

770 / 780

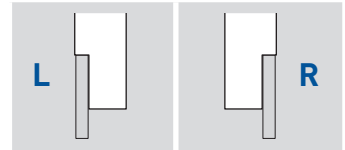
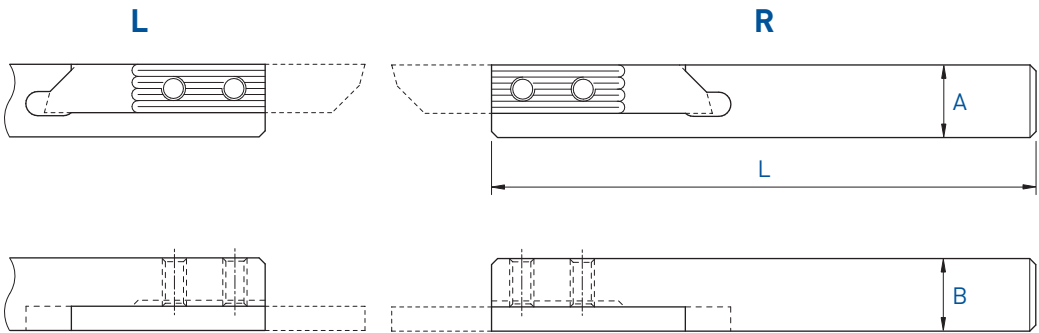

A x B	L	Serrage Spannsystem Clamping	Art. N°	Art. N°
10 x 10	115	A	770-10	780-10
12 x 12	130	A	770-12	780-12
12 x 12	90	A	770-12-90	780-12-90
12.7 x 12.7	130	A	770-12.7	780-12.7
14 x 14	130	A	770-14	780-14
16 x 16	130	A	770-16	780-16
16 x 16	75	A	770-16-75	780-16-75
20 x 20	120	A	770-20	780-20
25 x 25	140	A	770-25	780-25



Chaque support est livré avec vis et clé.
 Jeder Halter wird mit Spannschraube(n) und Schlüssel geliefert.
 Screw(s) and key are included with each tool holder.

Porte-outils avec arrosage intégré
 Halter mit integrierter Kühlmittelzufuhr
 Holders with integrated coolant supply

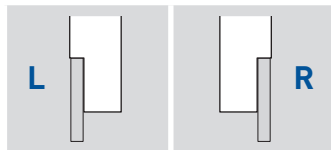
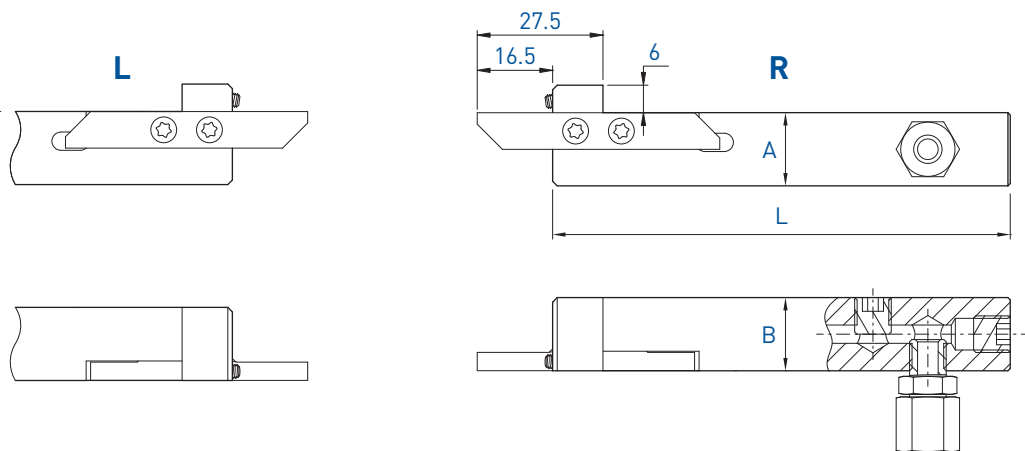

770-JET / 780-JET

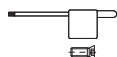

A x B	L	Serrage Spannsystem Clamping	Art. N°	Art. N°
16 x 16	100	A	770-16-JET	780-16-JET

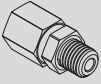

Chaque support est livré avec vis et clé.
 Jeder Halter wird mit Spannschraube(n)
 und Schlüssel geliefert.
 Screw(s) and key are included with each
 tool holder.

Pièces de rechange Ersatzteile Spare parts			Buse Düse Nozzle 
	Art. N°	Art. N°	Art. N°
770-JET / 780-JET	J-M8X1-D6	JB-M8X1	JJ-M3X6-D1.5

Porte-outils

Coupe déportée

Halter

Versetztes Schneiden

Holder

Cut off line

770RC

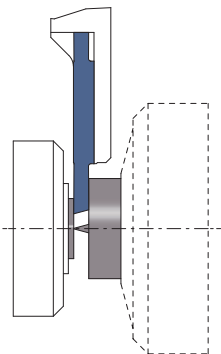
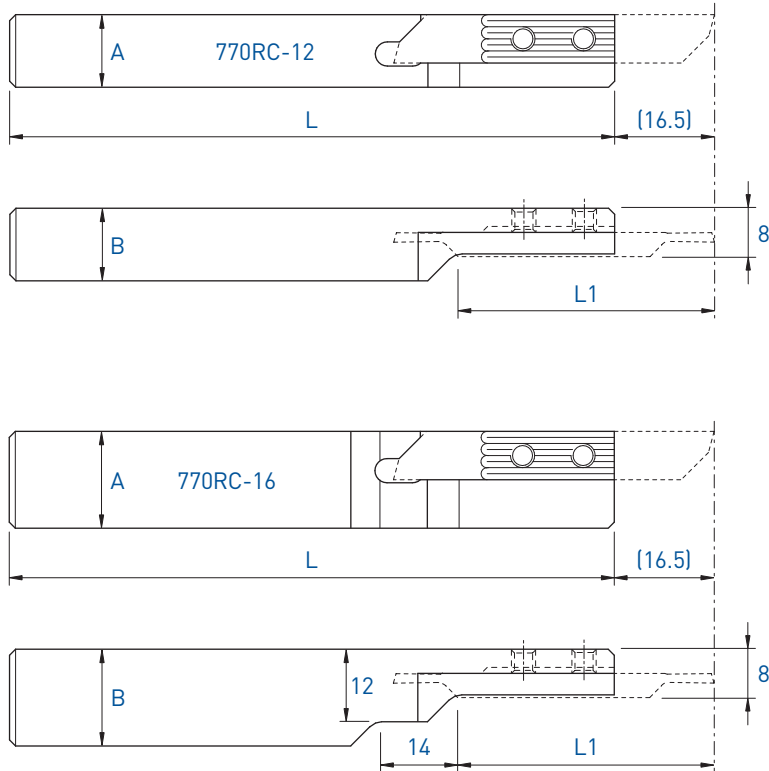

Utiliser des plaquettes type 771R
WSP Typ 771R verwenden
Use inserts type 771R

Voir pages 1.138 - 1.141
Siehe Seiten 1.138 - 1.141
See pages 1.138 - 1.141



Chaque support est livré avec vis et clé.
Jeder Halter wird mit Spannschraube(n) und Schlüssel geliefert.
Screw(s) and key are included with each tool holder.

L (R)

Coupe à droite déportée
Versetztes Rechtsschneiden
Right cut off line

A x B	L	L1	Serrage Spannsystem Clamping	Art. N°
12 x 12	130	42	A	770RC-12
16 x 16	130	42	A	770RC-16

Tronçonnage

Abstechen

Parting off

771 / 781

L

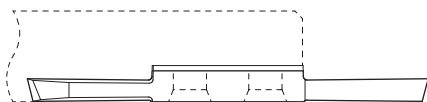
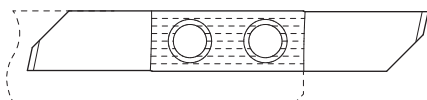

R

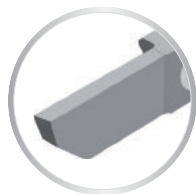
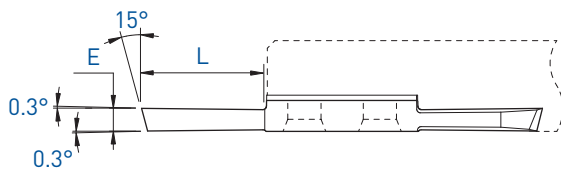
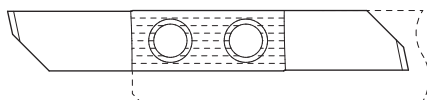

L



R



E	L	Art. N°	L			Art. N°	R		
			TiAlN	TiN	N (µk20)		TiAlN	TiN	N (µk20)
1.5	16	-				781-1.5	■	■	■
2.0	16	771-2.0	■	■	■	781-2.0	■	■	■
2.5	16	771-2.5	■	■	■	781-2.5	■	■	■
3.0	16	771-3.0	■	■	■	781-3.0	■	■	■
3.5	16	771-3.5	■	■	■	781-3.5	■	■	■

Tronçonnage

Abstechen

Parting off

771XF / 781XF

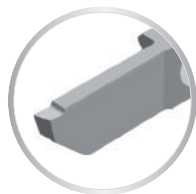
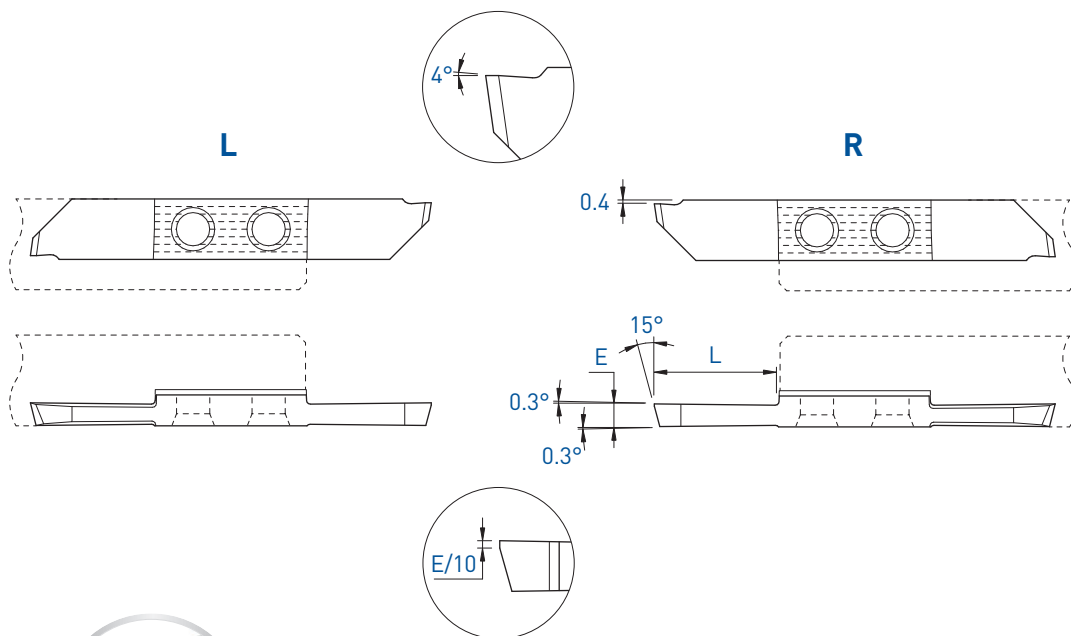

E	L	L			R				
		Art. N°	TiAlN	TiN	N (µk20)	Art. N°	TiAlN	TiN	N (µk20)
2.0	16	-				781XF-2.0	■	■	■
2.5	16	771XF-2.5	■	■	■	781XF-2.5	■	■	■
3.0	16	771XF-3.0	■	■	■	781XF-3.0	■	■	■
3.5	16	771XF-3.5	■	■	■	781XF-3.5	■	■	■

Tronçonnage

Abstechen

Parting off

Coupe déportée

Versetztes Schneiden

Cut off line

781L / 771R

Cut R

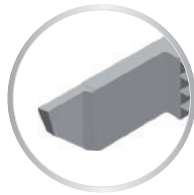
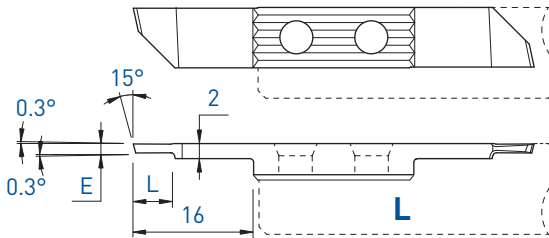

L (R)					
Coupe à droite déportée Versetztes Rechtsschneiden Right cut off line					
E	L	Art. N°	TiAlN	TiN	N (µk20)
1.0	5	771R-1.0	■	■	■
1.2	5	771R-1.2	■	■	■
1.5	8.5	771R-1.5	■	■	■

Cut L

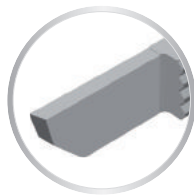
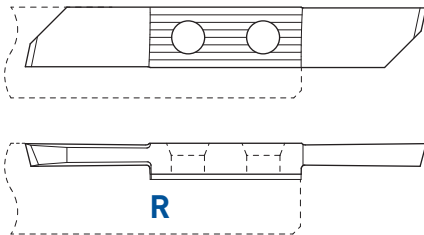

Cut R

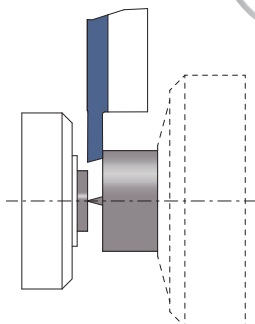
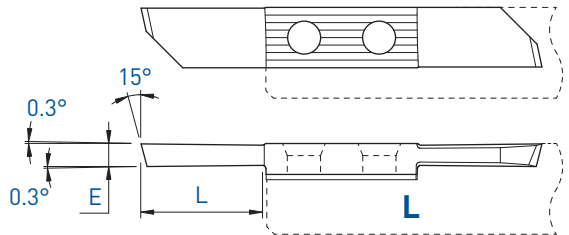

R (L)						L (R)					
Coupe à gauche déportée Versetztes Linksschneiden Left cut off line						Coupe à droite déportée Versetztes Rechtsschneiden Right cut off line					
E	L	Art. N°	TiAlN	TiN	N (µk20)	Art. N°	TiAlN	TiN	N (µk20)		
2.0	16	781L-2.0	■	■	■	771R-2.0	■	■	■		
2.5	16	781L-2.5	■	■	■	771R-2.5	■	■	■		
3.0	16	781L-3.0	■	■	■	771R-3.0	■	■	■		
3.5	16	781L-3.5	■	■	■	771R-3.5	■	■	■		

Tronçonnage

Abstechen

Parting off

Coupe déportée

Versetzt Schneiden

Cut off line

771RU

Cut R

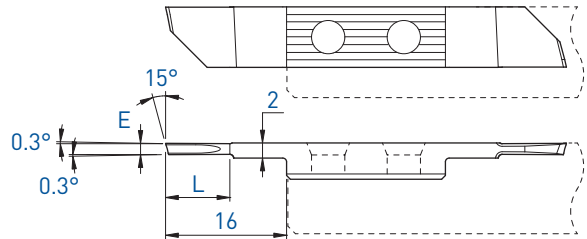

L (R)

Coupe à droite déportée
Versetzt Rechtsschneiden
Right cut off line

E	L	Art. N°	TiAlN	TiN	N (µk20)
1.0	5	771RU-1.0	■	□	■
1.5	8.5	771RU-1.5	■	□	■

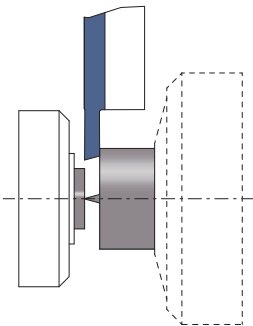

■ = disponible / verfügbar / available

□ = selon disponibilité du stock / jenach Lagerverfügbarkeit / depending on stock availability

TOP-LINE

Tronçonnage
Abstechen
Parting off

Coupe déportée
Versetztes Schneiden
Cut off line

781LXF / 771RXF

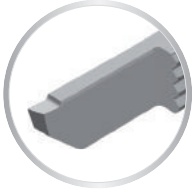
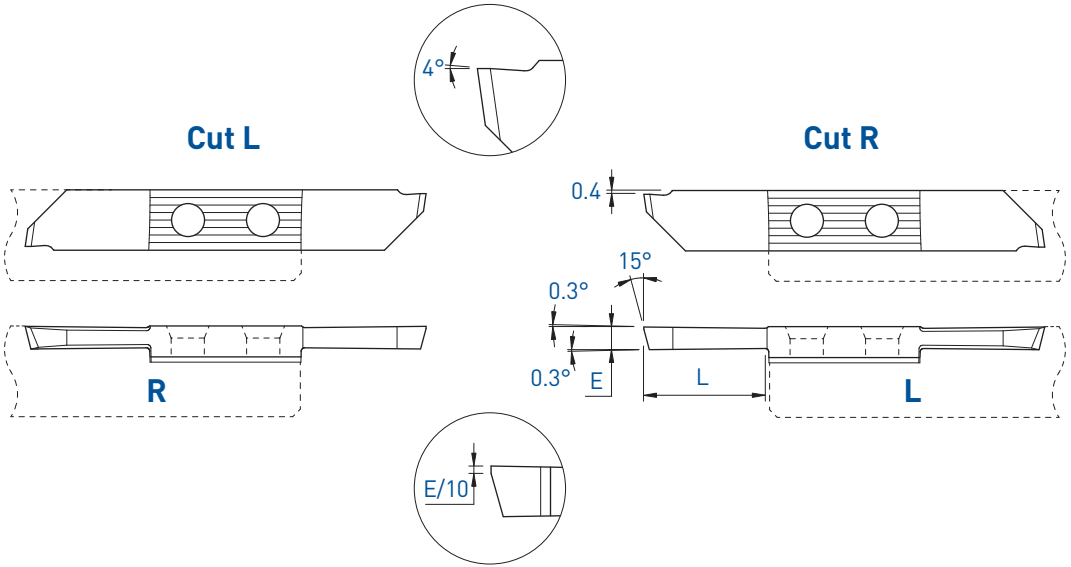

R (L)				L (R)			
Coupe à gauche déportée Versetztes Linksschneiden Left cut off line				Coupe à droite déportée Versetztes Rechtsschneiden Right cut off line			

E	L	Art. N°	TiAlN	TiN	N (µk20)	Art. N°	TiAlN	TiN	N (µk20)
2.0	16	-				771RXF-2.0	■	■	■
2.5	16	781LXF-2.5	■	■	■	771RXF-2.5	■	■	■
3.0	16	781LXF-3.0	■	■	■	771RXF-3.0	■	■	■
3.5	16	781LXF-3.5	■	■	■	771RXF-3.5	■	■	■

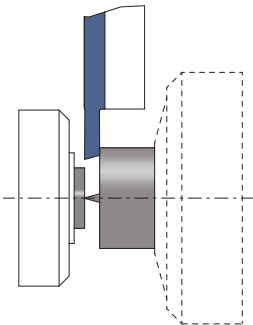

Tronçonnage
Abstechen
Parting off

Coupe déportée
Versetzttes Schneiden
Cut off line

771RD

Cut R

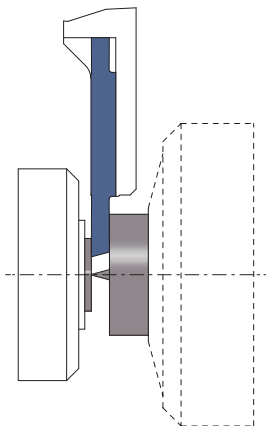
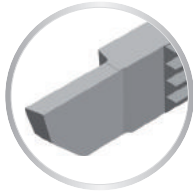
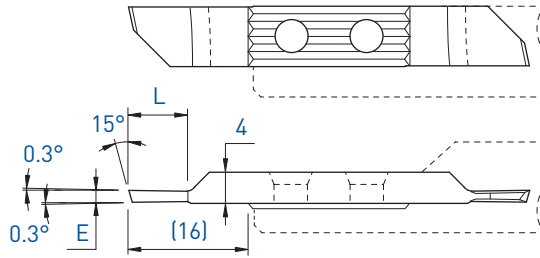

L (R)

Coupe à droite déportée
Versetzttes Rechtsschneiden
Right cut off line

E	L	Art. N°	TiAlN	TiN	N (µk20)
1.2	5	771RD-1.2	■	■	■
1.5	7.5	771RD-1.5	■	■	■
2.0	10	771RD-2.0	■	■	■

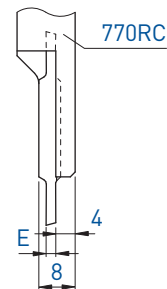

TOP-LINE

Plaquettes ébauches

WSP-Rohlinge

Blank inserts

771-E / 781-E

L

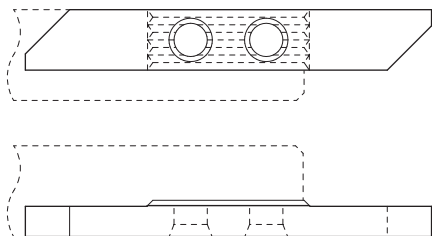

R

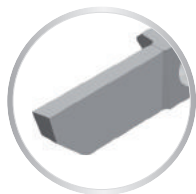
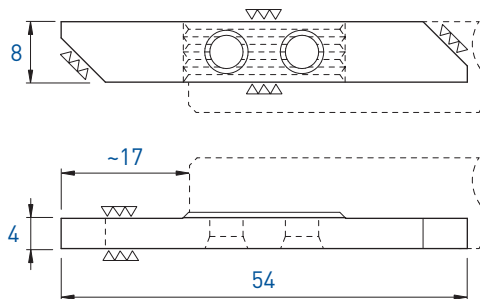

L		R	
Art. N°	N (µk20)	Art. N°	N (µk20)
771-E	■	781-E	■

Porte-outils

Halter

Holders

7050 / 7060

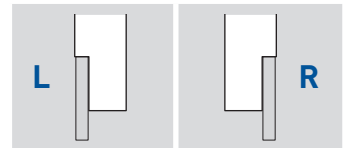
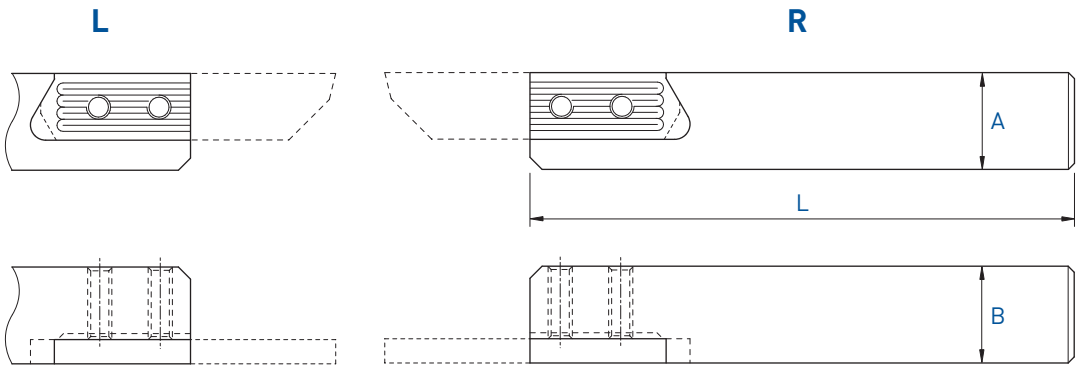

A x B	L	Serrage Spannsystem Clamping	Art. N°	Art. N°
16 x 16	130	A	7050-16	7060-16
16 x 16	75	A	7050-16-75	7060-16-75
20 x 20	120	A	7050-20	7060-20
25 x 25	140	A	7050-25	7060-25



Chaque support est livré avec vis et clé.
Jeder Halter wird mit Spannschraube(n) und Schlüssel geliefert.
Screw(s) and key are included with each tool holder.

■ = disponible / verfügbar / available

□ = selon disponibilité du stock / jenach Lagerverfügbarkeit / depending on stock availability

L

R

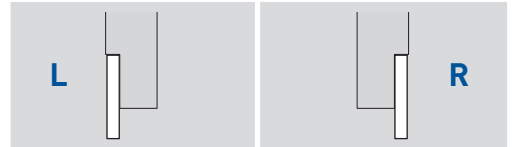
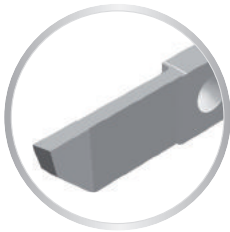
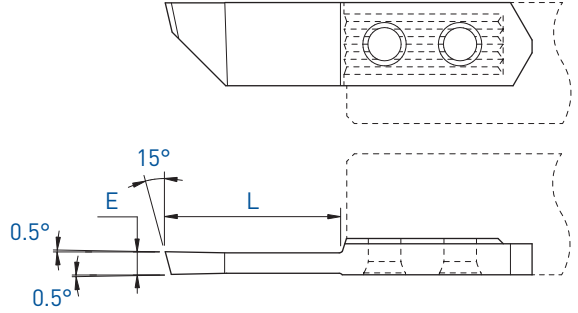
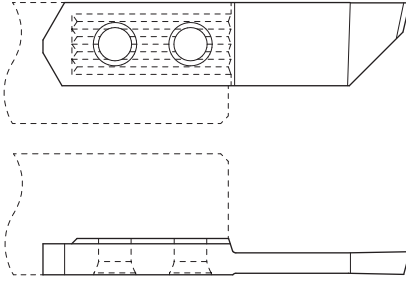

E	L	L			R				
		Art. N°	TiAlN	TiN	N [µk20]	Art. N°	TiAlN	TiN	N [µk20]
2.5	22	-				7061-2.5	■	■	■
3.0	22	7051-3.0	■	■	■	7061-3.0	■	■	■
3.5	22	-				7061-3.5	■	■	■

Tronçonnage

Abstechen

Parting off

7051XF / 7061XF

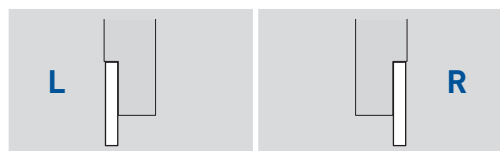
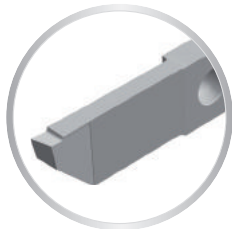
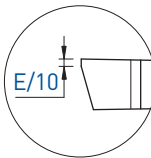
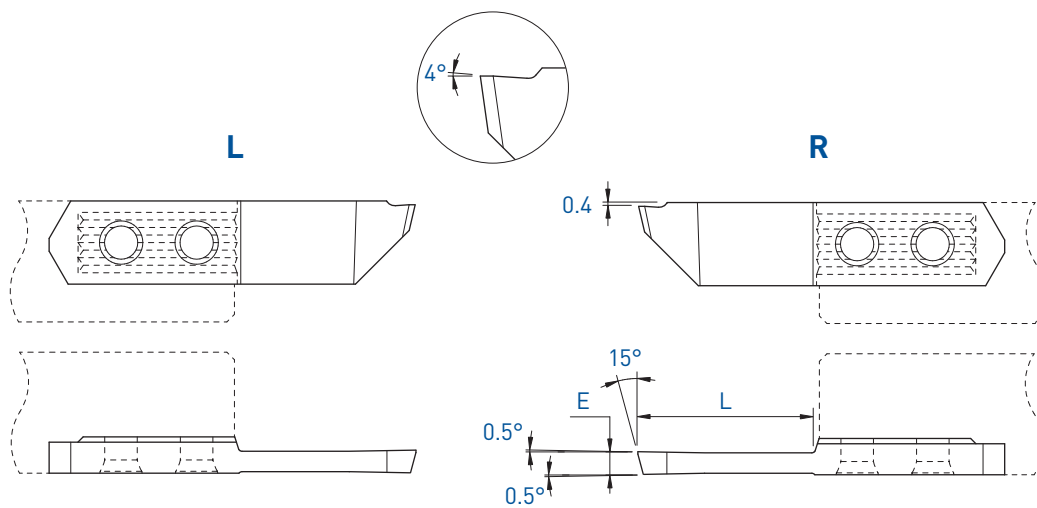

E	L	Art. N°	TiAlN	TiN	N [µk20]	Art. N°	TiAlN	TiN	N [µk20]
3.0	22	7051XF-3.0	■	■	■	7061XF-3.0	■	■	■

Tronçonnage
Abstechen
Parting off

Coupe déportée
Versetztes Schneiden
Cut off line

7061L / 7051R

Cut L

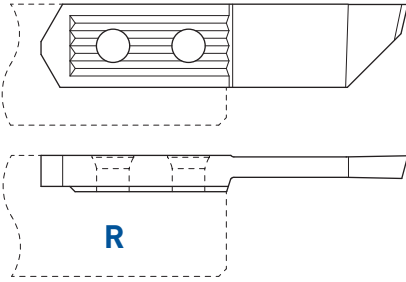

Cut R

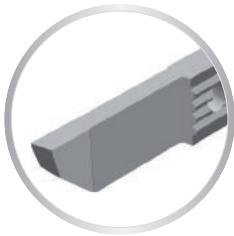
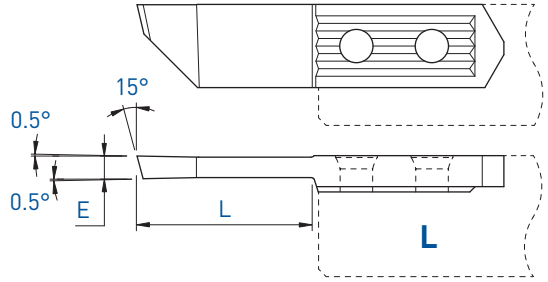

R (L)

Coupe à gauche déportée
Versetztes Linksschneiden
Left cut off line

L (R)

Coupe à droite déportée
Versetztes Rechtsschneiden
Right cut off line

E	L	Art. N°	TiAIN	TiN	N (µk20)	Art. N°	TiAIN	TiN	N (µk20)
2.5	22	-				7051R-2.5	■	■	■
3.0	22	7061L-3.0	■	■	■	7051R-3.0	■	■	■
3.5	22	-				7051R-3.5	■	■	■

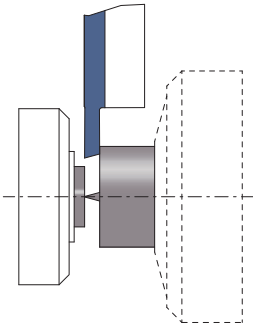

Tronçonnage
Abstechen
Parting off

Coupe déportée
Versetztes Schneiden
Cut off line

7061LXF / 7051RXF

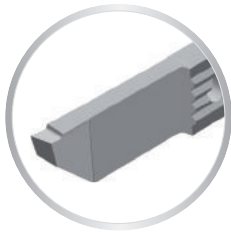
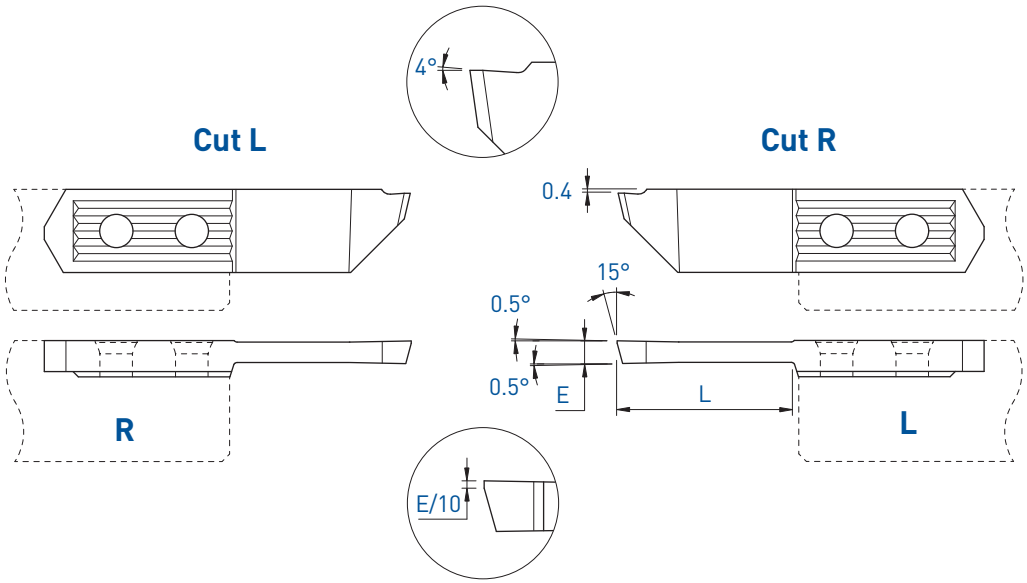

R (L)			L (R)		
Coupe à gauche déportée Versetztes Linksschneiden Left cut off line			Coupe à droite déportée Versetztes Rechtsschneiden Right cut off line		

E	L	Art. N°	TiAlN	TiN	N (µk20)	Art. N°	TiAlN	TiN	N (µk20)
3.0	22	7061LXF-3.0	■	■	■	7051RXF-3.0	■	■	■

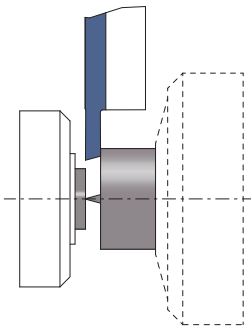

■ = disponible / verfügbar / available
□ = selon disponibilité du stock / jenach Lagerverfügbarkeit / depending on stock availability

L

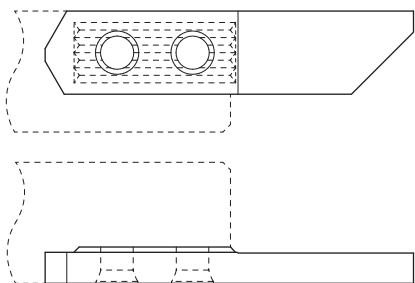

R

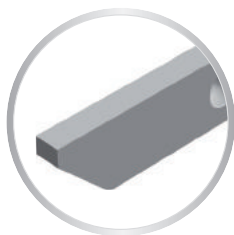
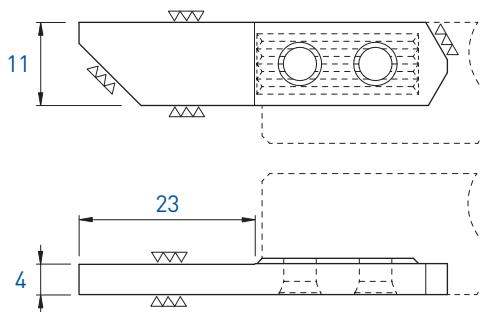

L		R	
Art. N°	N (µk20)	Art. N°	N (µk20)
7051-E	■	7061-E	■

Porte-outils

Halter

Holders

W750 / W760

L

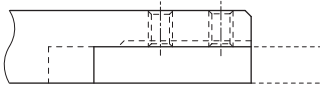
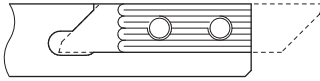

R

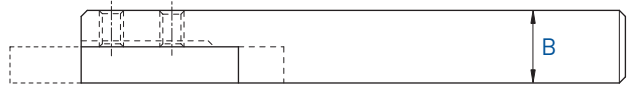
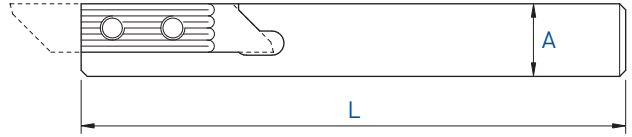

L

R

A x B	L	Serrage Spannsystem Clamping	Art. N°	Art. N°
12 x 12	130	A	W750-12	W760-12
16 x 16	130	A	W750-16	W760-16
20 x 20	120	A	W750-20	W760-20



Chaque support est livré avec vis et clé.
Jeder Halter wird mit Spannschraube(n) und Schlüssel geliefert.
Screw(s) and key are included with each tool holder.

■ = disponible / verfügbar / available

□ = selon disponibilité du stock / jenach Lagerverfügbarkeit / depending on stock availability

TOP-LINE

Porte-outils avec arrosage intégré
 Halter mit integrierter Kühlmittelzufuhr
 Holders with integrated coolant supply

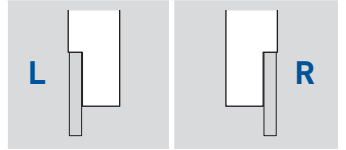
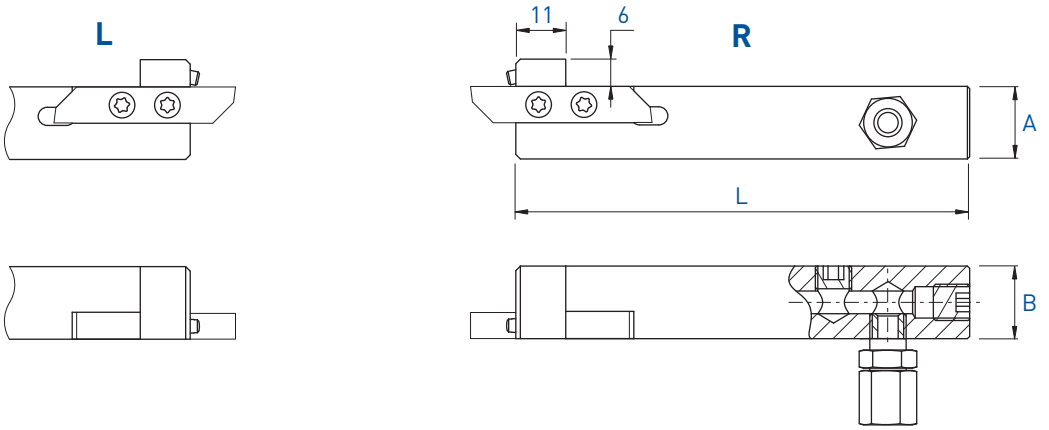

W750-JET / W760-JET

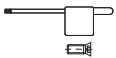

A x B	L	Serrage Spannsystem Clamping	Art. N°	Art. N°
16 x 16	100	A	W750-16-JET	W760-16-JET
20 x 20	100	A	W750-20-JET	W760-20-JET

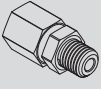

Chaque support est livré avec vis et clé.
 Jeder Halter wird mit Spannschraube(n)
 und Schlüssel geliefert.
 Screw(s) and key are included with each
 tool holder.

Pièces de rechange Ersatzteile Spare parts			Buse Düse Nozzle
	Art. N°	Art. N°	Art. N°
W750-JET / W760-JET	J-M8X1-D6	JB-M8X1	JJ-M3X6-D1.5

Plaquettes ébauches
WSP-Rohlinge
Blank inserts

W751-E5 / W761-E5
W751-EP5 / W761-EP5

L

R

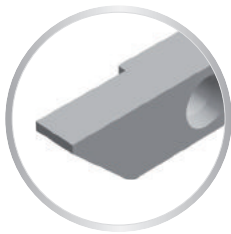
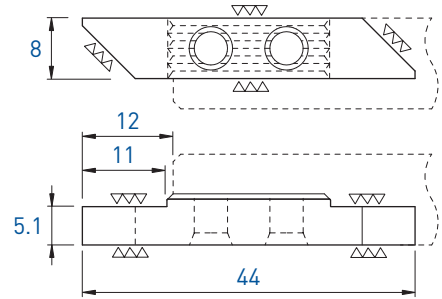
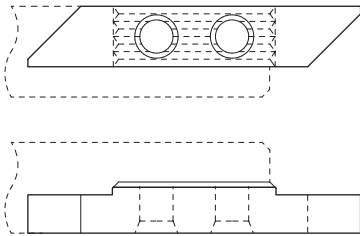

L		R	
Art. N°	N (µk20)	Art. N°	N (µk20)
W751-E5	■	W761-E5	■

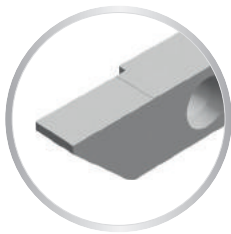
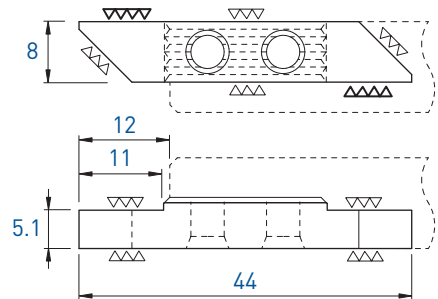
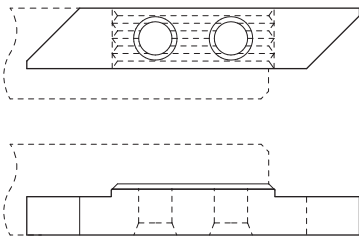

L		R	
Art. N°	N (µk20)	Art. N°	N (µk20)
W751-EP5	■	W761-EP5	■

TOP-LINE

Plaquettes ébauches
WSP-Rohlinge
Blank inserts

W751-E6 / W761-E6
W751-EP6 / W761-EP6

L

R

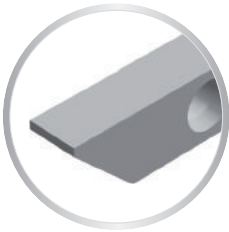
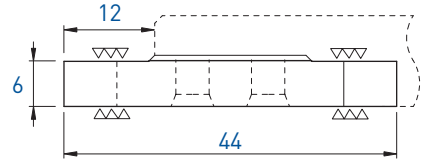
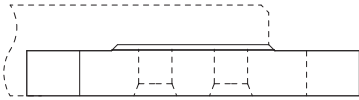
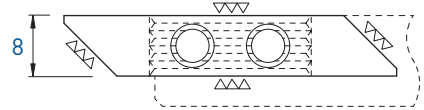
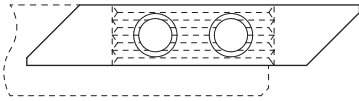

L		R	
Art. N°	N (µk20)	Art. N°	N (µk20)
W751-E6	■	W761-E6	■

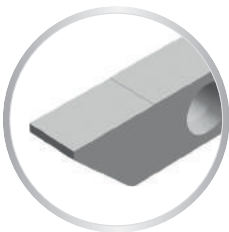
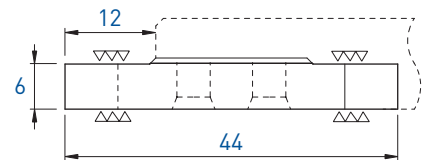
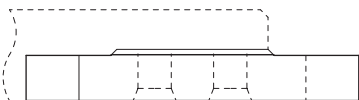
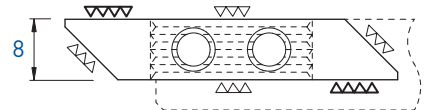
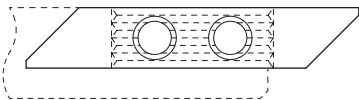

L		R	
Art. N°	N (µk20)	Art. N°	N (µk20)
W751-EP6	■	W761-EP6	■

Interface polygonale PSC
 Polygonal Schnittstelle PSC
 Polygonal interface PSC

R

C3 / C4

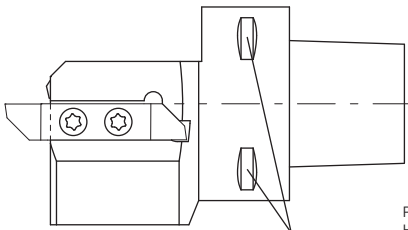
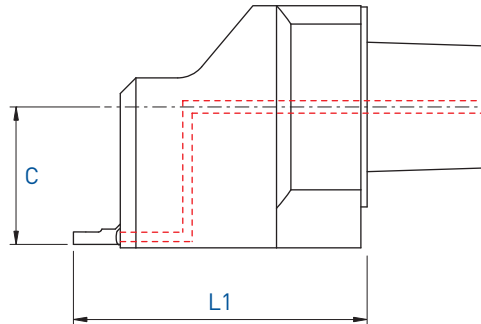
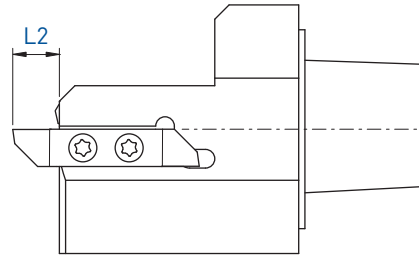
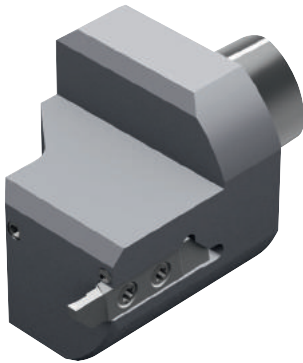

Porte-outils pour changeur automatique sur demande.
 Halter für Werkzeugwechsler auf Anfrage.
 Holders for tool changer on request.

Type	Plaquettes type WSP Typ Insert type	Pages Seiten Pages	L1	C	L2	Art. N°	Buse Düse Nozzle
							Art. N°
C3	740	> 1.32	47	22	7.5	C3-740-22047	JJ-M3X6-D1.5
C3	760	> 1.78	47	22	10	C3-760-22047	JJ-M3X6-D1.5
C4	760	> 1.78	62	27	10	C4-760-27062	JJ-M3X6-D1.5

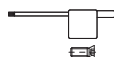

Chaque support est livré avec vis et clé.
 Jeder Halter wird mit Spannschraube(n) und Schlüssel geliefert.
 Screw(s) and key are included with each tool holder.

■ = disponible / verfügbar / available
 □ = selon disponibilité du stock / jenach Lagerverfügbarkeit / depending on stock availability

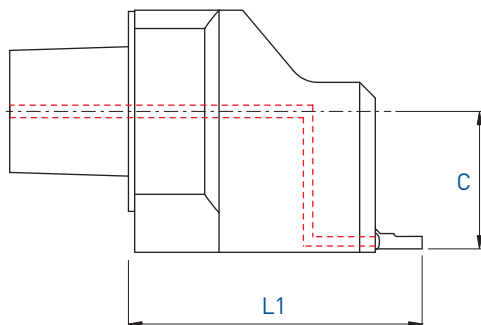
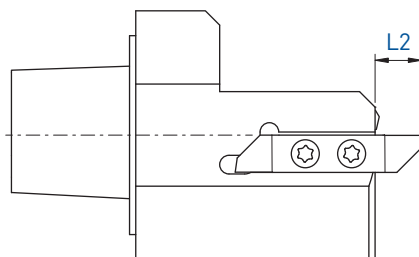
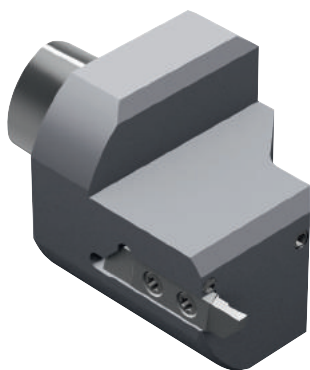

Type	Plaquettes type WSP Typ Insert type	Pages Seiten Pages	L1	C	L2	Art. N°	Buse Düse Nozzle Art. N°
C4	750	> 1.78	62	27	10	C4-750-27062	JJ-M3X6-D1.5



Chaque support est livré avec vis et clé.
 Jeder Halter wird mit Spannschraube(n) und Schlüssel geliefert.
 Screw(s) and key are included with each tool holder.

Porte-outils

Halter

Holders

HSK

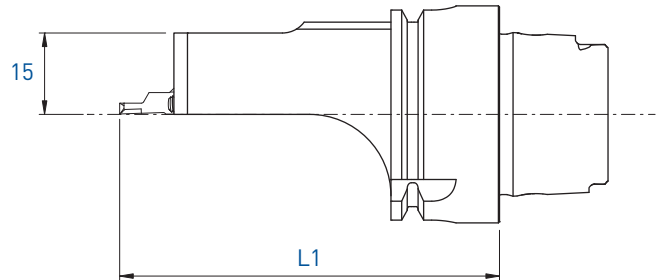
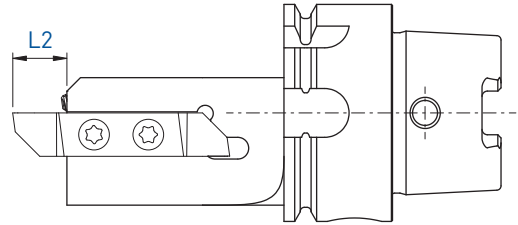

Utilisable sur toutes les machines avec broches HSK-T ou HSK-A

Auf allen Maschinen mit HSK-T oder HSK-A verwendbar

Applicable on all machines with HSK-T or HSK-A spindle

Plaquettes type WSP Typ Insert type	Pages Seiten Pages	L1	L2	Art. N°	Buse Düse Nozzle
					Art. N°
740	> 1.32	65	7.5	HSK-T40-740-0065-JET HSK-A40-S191-740-0065-JET*	JJ-M3X6-D1.5
760	> 1.78	70	10	HSK-T40-760-0070-JET HSK-A40-S191-760-0070-JET*	JJ-M3X6-D1.5

* pour machines Bumotec
für Bumotec Maschinen
for Bumotec machines



Chaque support est livré avec vis et clé.
Jeder Halter wird mit Spannschraube(n) und Schlüssel geliefert.
Screw(s) and key are included with each tool holder.

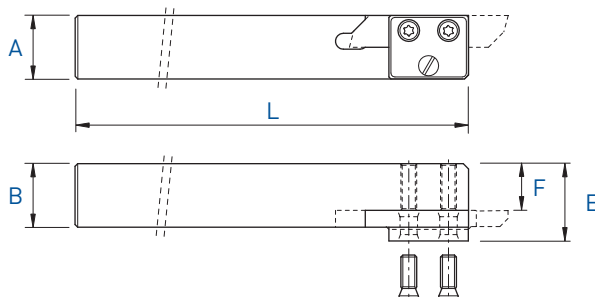
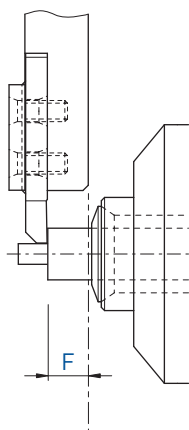

740 Series

A x B	L	F	E	Art. N°	Plaquettes type WSP Typ Inserts type	Pages Seiten Pages
12 x 12	130	9.5	14.5	740Z-12	741 - 747	> 1.32
16 x 16	130	13.5	18.5	740Z-16	741 - 747	> 1.32

760 Series

A x B	L	F	E	Art. N°	Plaquettes type WSP Typ Inserts type	Pages Seiten Pages
12 x 12	130	8	15	760Z-12	761 - 767	> 1.78
16 x 16	130	12	19	760Z-16	761 - 767	> 1.78

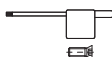

Chaque support est livré avec vis et clé.
Jeder Halter wird mit Spannschraube(n) und Schlüssel geliefert.
Screw(s) and key are included with each tool holder.

Porte-outils pour machine Tornos

Halter für Tornos Maschine

Holders for Tornos machine

R

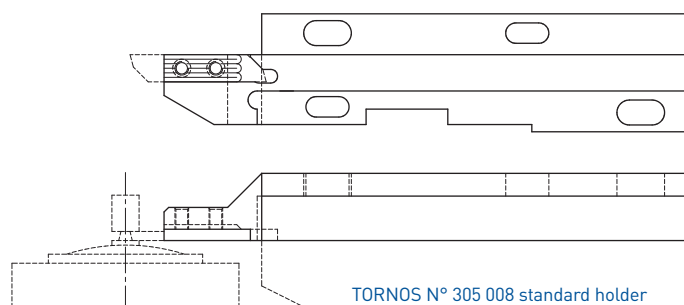
DECO 7/10
EvoDECO 10Coupe à droite
Rechtsschneiden
Right hand cut

Art. N°	Plaquettes type WSP Typ Inserts type	Pages Seiten Pages
740-DECO10	741 - 747	> 1.32

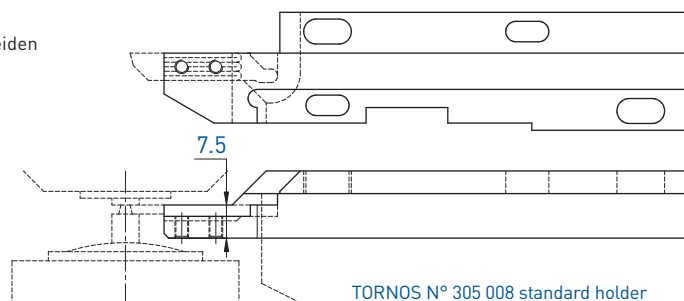
Coupe à droite déportée
Versetztes Rechtsschneiden
Right cut off line

Art. N°	Plaquettes type WSP Typ Inserts type	Pages Seiten Pages
730R-DECO10	731R / 731N	1.39 - 1.45

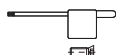

Chaque support est livré avec vis et clé.
Jeder Halter wird mit Spannschraube(n) und Schlüssel geliefert.
Screw(s) and key are included with each tool holder.

Porte-outils pour machine Tornos

Halter für Tornos Maschine

Holders for Tornos machine

R

DECO 7/10
EvoDECO 10

Pour le tronçonnage de petites pièces
Zum Abstechen von kleinen Werkstücken
For small parts parting off



Réglable en longueur
Längseinstellbar
Adjustable length

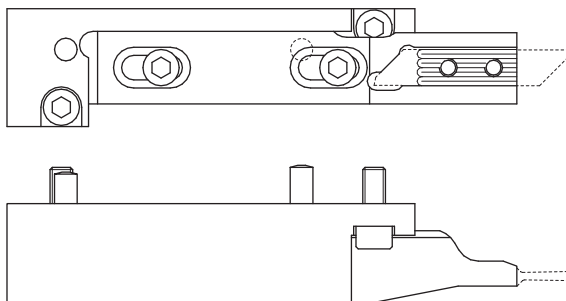

Art. N°	Plaquettes type WSP Typ Inserts type	Pages Seiten Pages
750R-DECO10	751R / 751N	1.88 - 1.99

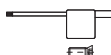
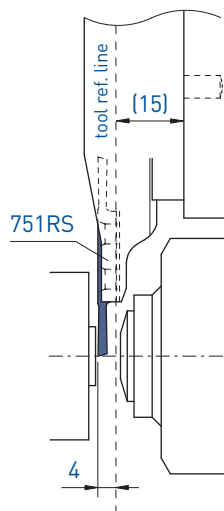
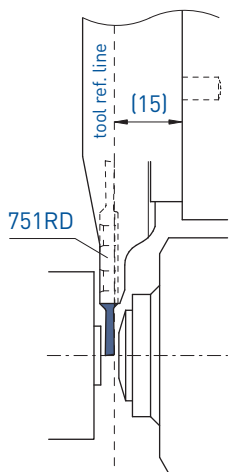

Chaque support est livré avec vis et clé.
Jeder Halter wird mit Spannschraub(n) und Schlüssel geliefert.
Screw(s) and key are included with each tool holder.

Porte-outils pour machine Tornos

Halter für Tornos Maschine

Holders for Tornos machine

L

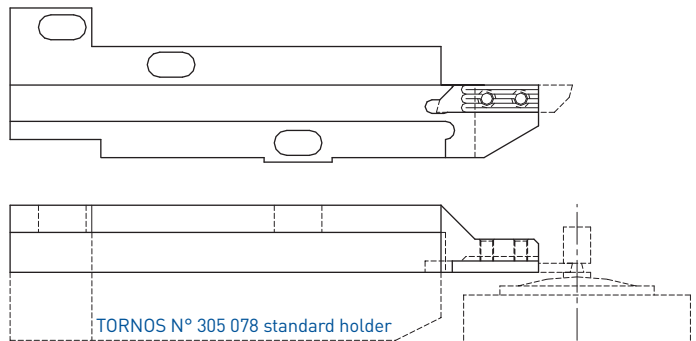
DECO 7/10
EvoDECO 10Coupe à gauche
Linksschneiden
Left hand cut

Art. N°	Plaquettes type WSP Typ Inserts type	Pages Seiten Pages
730-DECO10	731 - 737	> 1.32

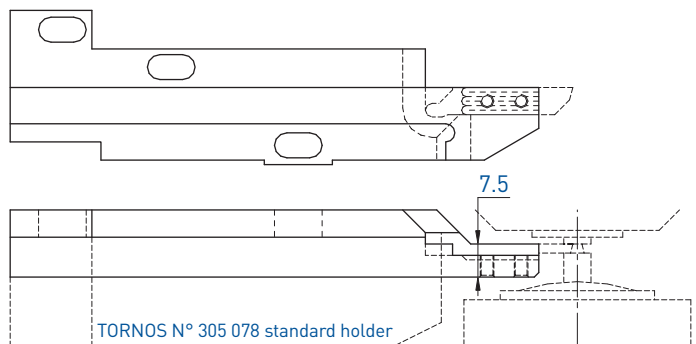
Coupe à gauche déportée
Versetztes Linksschneiden
Left cut off line

Art. N°	Plaquettes type WSP Typ Inserts type	Pages Seiten Pages
740L-DECO10	741L / 741N	1.39 - 1.45

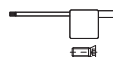

Chaque support est livré avec vis et clé.
Jeder Halter wird mit Spannschraub(en) und Schlüssel geliefert.
Screw(s) and key are included with each tool holder.

Porte-outils pour machine Tornos

Halter für Tornos Maschine

Holders for Tornos machine

L

DECO 7/10
EvoDECO 10

Pour le tronçonnage de petites pièces
Zum Abstechen von kleinen Werkstücken
For small parts parting off



Réglable en longueur
Längseinstellbar
Adjustable length

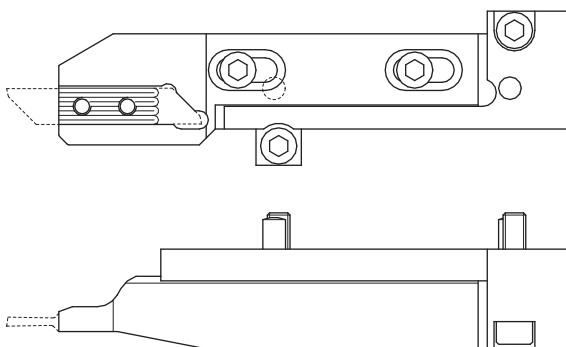

Art. N°	Plaquettes type WSP Typ Inserts type	Pages Seiten Pages
760L-DECO10	761L / 761N	1.88 - 1.98

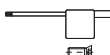
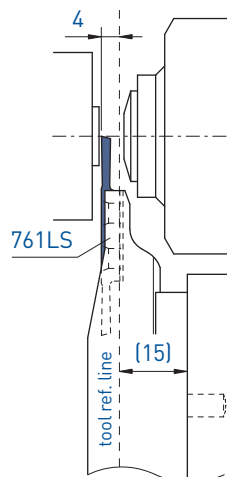
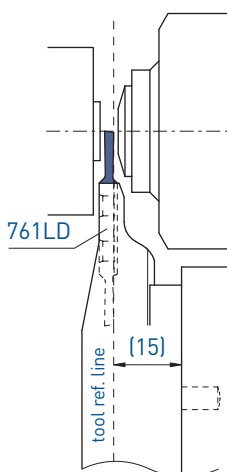

Chaque support est livré avec vis et clé.
Jeder Halter wird mit Spannschraubel(n) und Schlüssel geliefert.
Screw(s) and key are included with each tool holder.

Porte-outils pour machine Tornos

Halter für Tornos Maschine

Holders for Tornos machine

DECO 13
EvoDECO 16

Pour le tronçonnage de petites pièces
Zum Abstechen von kleinen Werkstücken
For small parts parting off

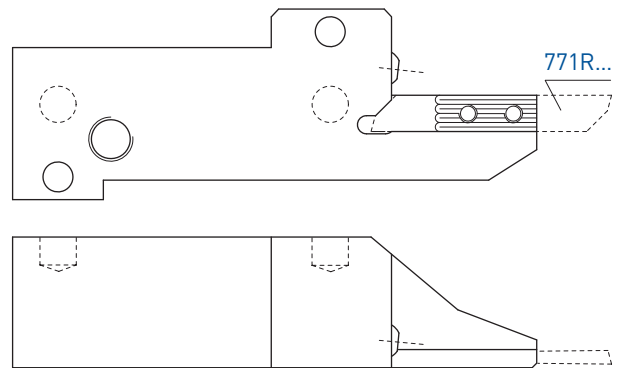

Art. N°	Plaquettes type WSP Typ Inserts type	Pages Seiten Pages
770R-DECO13	771R	1.138 - 1.141

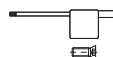
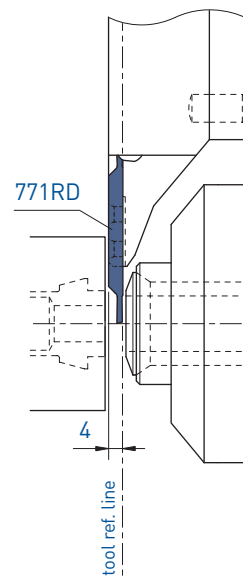
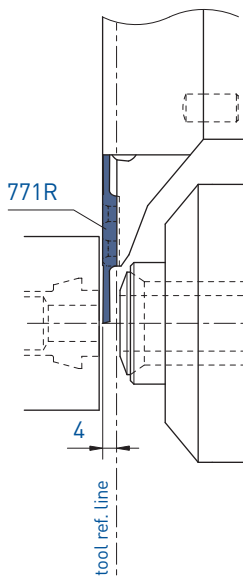

Chaque support est livré avec vis et clé.
Jeder Halter wird mit Spannschraube(n) und Schlüssel geliefert.
Screw(s) and key are included with each tool holder.

Pour le tronçonnage de petites pièces
 Zum Abstechen von kleinen Werkstücken
 For small parts parting off

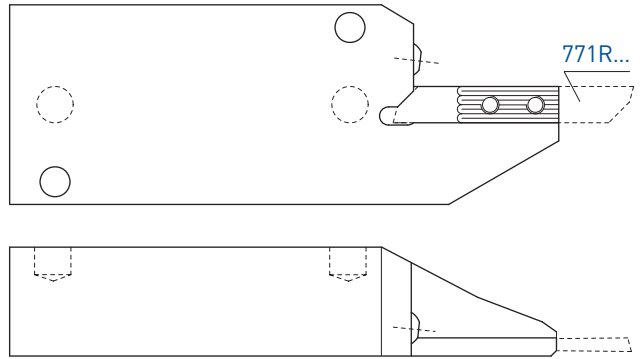

Art. N°	Plaquettes type WSP Typ Inserts type	Pages Seiten Pages
770R-DECO20	771R	1.138 - 1.141

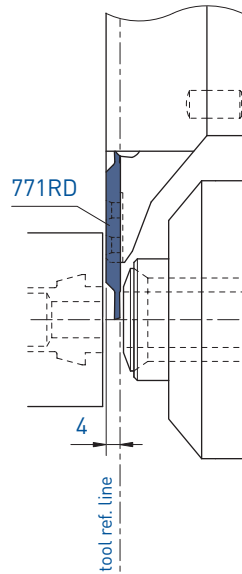
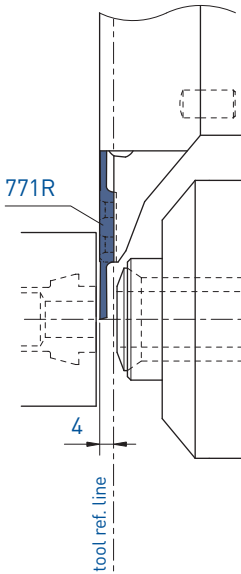

Chaque support est livré avec vis et clé.
 Jeder Halter wird mit Spannschraube(n) und Schlüssel geliefert.
 Screw(s) and key are included with each tool holder.

Porte-outils pour machine Tornos

Halter für Tornos Maschine

Holder for Tornos machine

MultiSwiss 6x16

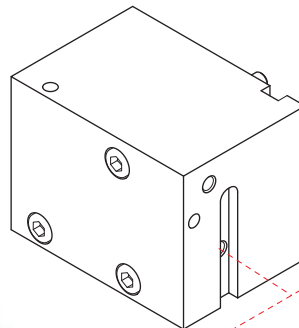
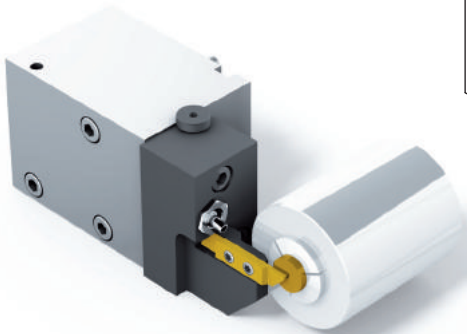
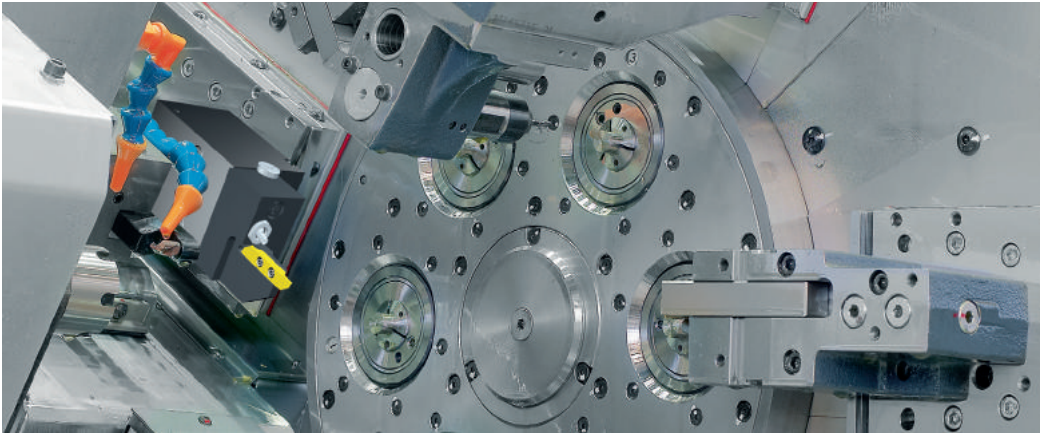

750R-MULTISWISS

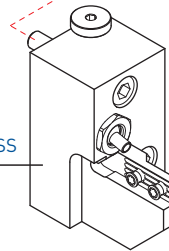

730R-MULTISWISS

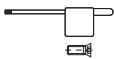

Chaque support est livré avec vis et clé.
Jeder Halter wird mit Spannschraube(n) und Schlüssel geliefert.
Screw(s) and key are included with each tool holder.

Art. N°	Plaquettes type WSP Typ Inserts type	Pages Seiten Pages
730R-MULTISWISS	731R / 731N	1.39 - 1.45
750R-MULTISWISS	751R / 751N	1.88 - 1.99

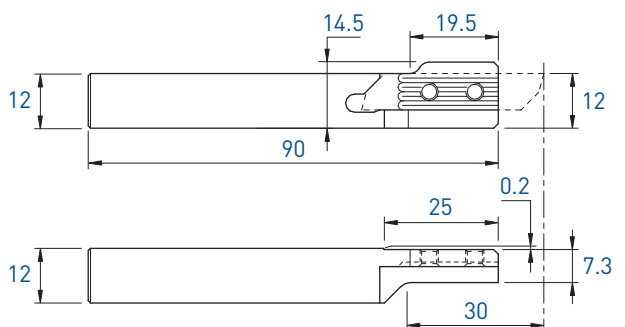

Art. N°	Plaquettes type WSP Typ Inserts type	Pages Seiten Pages
750RAS-12	751R	1.88 - 1.96

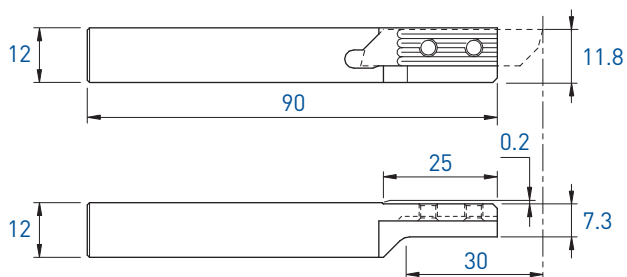

Art. N°	Plaquettes type WSP Typ Inserts type	Pages Seiten Pages
750RAS-12-H11.8	751R	1.88 - 1.96

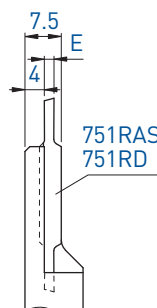
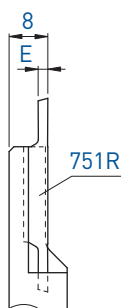
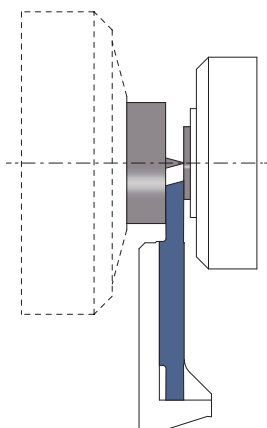

(p. 1.98 - 1.99)



Chaque support est livré avec vis et clé.
Jeder Halter wird mit Spannschraube(n) und Schlüssel geliefert.
Screw(s) and key are included with each tool holder.

Porte-outils

Halter

Holder

Schütze

DT20

DT30

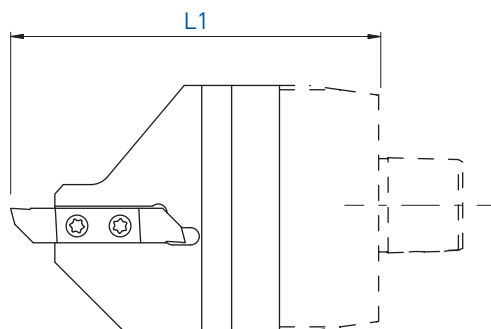

Compatibility Schütze

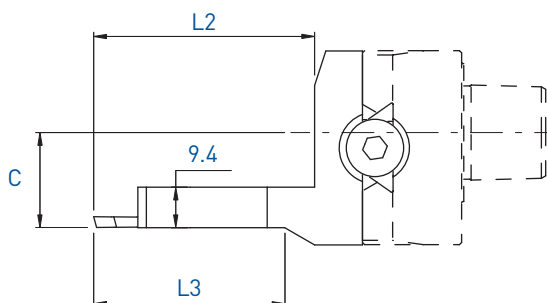
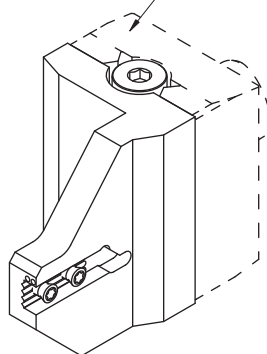

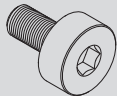

Plaquettes type WSP Typ Inserts type	Pages Seiten Pages	L1	C	L2	L3	Art. N°	Compatibility Schütze	
								Art. N°
761-767	> 1.78	86	22	51	44	DT20-760-JET	C3-75870949	V-M6X0.5-14-L18
		83	27.5	48	-	DT30-760-JET	C4-75836783	

Vis et clés de rechange

Ersatzschrauben und Schlüssel



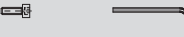

Spare screws and keys

	Porte-outils Halter Holders	Serrage standard (A) Standard Spannsystem (A) Standard clamping system (A) 	Serrage type B Spannsystem Typ B Clamping system type B 
710	710-6 / - NOVIBRA	V-M2.5X5.8-T8	-
	710-7 / - NOVIBRA	V-M2.5X6.5-T8	
	710-8 / - NOVIBRA	C-T8	
	710-10 - 710-12		
720	720-7	V-M2.5X6.5-T8	-
	720-8 - 720-12	V-M2.5X7.8-T8	
730	730-7 / - JET / -NOVIBRA	V-M3X7-T8	-
	730-8 / -NOVIBRA		V-M2.5X7.8-T8
	730-10 - 730-20		C-T8
	730-DECO10		-
	730R-DECO10		-
730RC	V-M3X5.5-T8	-	
740	740-7 / -JET / -NOVIBRA	V-M3X7-T8	-
	740-8 / -NOVIBRA -		V-M2.5X7.8-T8
	740-12 / -JET / -NOVIBRA		C-T8
	740-16 - 740-20		-
	740/730-D		
	740-C		
	740-DECO10		
740L-DECO10			
740-Z	V-M3X9-T8		
	Porte-outils Halter Holders	Serrage standard (A) Standard Spannsystem (A) Standard clamping system (A) 	Serrage type B Spannsystem Typ B Clamping system type B 
750	750-10 - 750-12 / -JET	V-M4X9-T15	-
	750-10-AB		V-M3X10-BN11
	750-12-AB		V-M3X8-BN11
	750-12.7 - 750-14		V-M3X10-BN11
	750-16		V-M3X12-BN11
	750-20		V-M3X16-BN11
	750RAS - 750-RC		V-M4X7.3-T15
750R-DECO10	V-M4X5.6-T15	-	
760	760-10 - 760-12 / -JET / -NOVIBRA /	V-M4X9-T15	-
	760/750		V-M3X10-BN21
	760-10-AB		V-M3X8-BN11
	760-12-AB		V-M3X10-BN11
	760-12.7 - 760-14		V-M3X12-BN11
	760-16		V-M3X16-BN11
	760-20		-
	760LC		V-M4X7.3-T15
760L-DECO10	V-M4X5.6-T15	-	
760-Z	V-M4X12-T15	-	

Vis et clés de rechange

Ersatzschrauben und Schlüssel

Spare screws and keys

	Porte-outils Halter Holders	Serrage standard (A) Standard Spannsystem (A) Standard clamping system (A)		Serrage type B Spannsystem Typ B Clamping system type B	
					
770	770 / -JET	V-M4X9-T15	C-T15	-	-
	770RC	V-M4X7.3-T15			
780	780 / -JET	V-M4X9-T15	C-T15	-	-
7050	7050	V-M4X9-T15	C-T15	-	-
7060	7060	V-M4X9-T15	C-T15	-	-
W	W750 / W760 / -JET	V-M4X11.5-T15	C-T15	-	-
C3	C3-740	V-M3X7-T8	C-T8	-	-
	C3-760	V-M4X9-T15	C-T15		
C4	C4-750	V-M4X9-T15	C-T15	-	-
	C4-760				
HSK	HSK-T40-740	V-M3X7-T8	C-T8	-	-
	HSK-T40-760	V-M4X9-T15	C-T15		
MultiSwiss	730R-MULTISWISS	V-M3X5.5-T8	C-T8	-	-
	750R-MULTISWISS	V-M4X7.3-T15	C-T15		
Schütte	DT20-760-JET	V-M4X9-T15	C-T15	-	-
	DT30-760-JET				