

Adaptations disponibles pour les machines suivantes:  
 Verfügbare Anpassungen für folgende Maschinen:  
 Available adapters for the following machines:

**Citizen - Hanwha -  
 Manurhin - Metafil - > 12.06  
 Star - Tornos - Tsugami**

Porte-outils  
 Halter  
 Holders

INFO > 12.60

**ML12**



**ML16**



Right cut

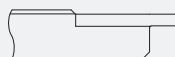

TOP-Line > 12.64

TURN-Line > 12.65

ISO-Line > 12.66

EVOCUT-Line > 12.68

CUT-Line > 12.69

PRO-Line > 12.70

ECO-Line > 12.70

IN-Line > 12.71

TOOLING-Line > 12.73

Cut off line



TOP-Line > 12.74

TURN-Line > 12.76

ISO-Line > 12.77

EVOCUT-Line > 12.78

CUT-Line > 12.79

PRO-Line > 12.80

ECO-Line > 12.81

Modules d'arrosage et de serrage  
 Kühlmittelzufuhr- und Spannelemente  
 Coolant and clamping supply unit

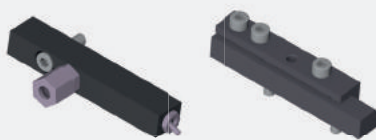

> 12.82

Banc de pré réglage  
 Voreinstellgerät  
 Presetting device

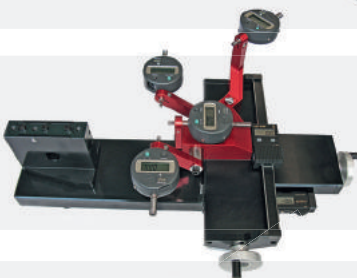

> 12.84

Pièces de rechange  
 Ersatzteile  
 Spare parts





> 12.86

Adaptations disponibles pour les machines suivantes

Verfügbare Anpassungen für folgende Maschinen

Available adapters for the following machines

Fabricant Hersteller Manufacturer	Machine Maschine Machine	Adaptations Anpassungen Adapters	Type Typ Type	Page Seite Page	
Citizen	C12/C16	ML12-CITIZEN-C16	ML12	12.06	
	L12-1M7	ML12-CITIZEN-L12-1M7		12.07	
	L12-2M10	ML12-CITIZEN-L12-2M10		12.08	
	M16V/VIII	ML12-CITIZEN-M16V/VIII		12.09	
	R04			ML12-CITIZEN-R04-QTF3101-3T	12.12
				ML12-CITIZEN-R04-QTF5008-4T	12.10
				ML12-CITIZEN-R04-QTF5108-4T	
	R07			ML12-CITIZEN-R07-QTF4008-5T	12.13
				ML12-CITIZEN-R07-QTF4108-6T	
				ML12-CITIZEN-R07-QTF4208-3T	
				ML12-CITIZEN-R07-QTF4608-4T	
	K12/K16	ML16-CITIZEN-K16		ML16	12.15
L16/L20-5M1/5M7	ML16-CITIZEN-L20	12.16			
L20E-1M8/L20X-1M10/ L20-2M8/2M12	ML16-CITIZEN-L20E		12.17		
Hanwha	XD20M	ML12-HANWHA-XD20M	ML12	12.18	
	SL12/16	ML16-HANWHA-SL12/16	ML16	12.19	
Manuhrin	KMX 426/526/626/ Swingg 20-26 MM	ML16-KMX26-DUO	ML16	12.20	
		ML16-KMX26-JET			
Metafil	D3/D10/D13	ML12-D10-3T	ML12	12.21	
Star	SB-12RG	ML12-STAR-SB-12RG	ML12	12.22	
	SR-10J	ML12-STAR-SR-10J		12.23	
	SW-12RII	ML12-STAR-SW-12RII-2T		12.24	
		ML12-STAR-SW-12RII-8T			
	SA-12/SA-16/SA-16R	ML16-STAR-SA-16	ML16	12.25	
	SB-16	ML16-STAR-SB-16		12.26	
	SB-16/20RG	ML16-STAR-SB-16/20RG		12.27	
	SB-20C/E	ML16-STAR-SB-20		12.28	
	SR-16R/SR-20R/SR-20RII	ML16-STAR-SR-20R		12.29	
	SR-20J/SR-20RIII	ML16-STAR-SR-20J		12.30	
	SR-20JII-A/B	ML16-STAR-SR-20JII-A/B 		12.31	
	SR-20RIV	ML16-STAR-SR-20RIV-2T		12.32	
		ML16-STAR-SR-20RIV-6T			
	SR-32J	ML16-STAR-SR-32J		12.33	
	SV-12/20	ML16-STAR-SV-12/20 		12.35	
	SV-20R	ML16-STAR-SV-20R		12.35	
	SW-20R	ML16-STAR-SW-20R-2T		12.36	
ML16-STAR-SW-20R-6T					

**Adaptations disponibles pour les machines suivantes**
**Verfügbare Anpassungen für folgende Maschinen**
**Available adapters for the following machines**

Fabricant Hersteller Manufacturer	Machine Maschine Machine	Adaptations Anpassungen Adapters	Type Typ Type	Page Seite Page
Tornos	DEC07/10 - EvoDECO 10	ML12-DEC010-DUO	ML12	12.37
		ML12-DEC010-JET		
	SWISS-NANO /SWISS-NANO 7	ML12-SWISS-NANO-2T		12.40
		ML12-SWISS-NANO-3T		
		ML12-SWISS-NANO-6T		
	SWISS-NANO 7	ML12-SWISS-NANO-4T		12.38
	DT13	ML12-DT13-2020206-9T		12.41
	CT20	ML12-CT20-2020019-7T		12.42
	GT13	ML12-GT13-390224-5T		12.43
		ML12-GT13-390223-7T		
	GT26	ML16-GT26-386210-5T		12.44
		ML16-GT26-386209-6T		
	GT32	ML16-GT32-389210-4T		12.46
		ML16-GT32-389209-5T		
	DEC013- EvoDECO16	ML16-DEC013-DUO		12.48
		ML16-DEC013-JET		
DEC020/26 - EvoDECO20/32	ML16-DEC020-DUO	12.50		
	ML16-DEC020-JET			
SIGMA20/32	ML16-S20-DUO	12.51		
	ML16-S20-JET			
SWISS ST26	ML16-SWISS-ST26-DUO	12.52		
	ML16-SWISS-ST26-JET			
DT26	ML16-DT26-2020206-7T	12.53		
Tsugami	B074	ML12-B074-1-6T	ML12	12.54
	B075	ML12-B075-1-8T		12.55
	PO34	ML12-PO34-1-5T		12.56
		ML12-PO34-1-7T		
		ML12-PO34-2-4T		
		ML12-PO34-2-10T		

**Citizen C12 / C16**

+ 2 outils (max 8)  
 + 2 Werkzeuge (max 8)  
 + 2 tools (max 8)

**ML12**

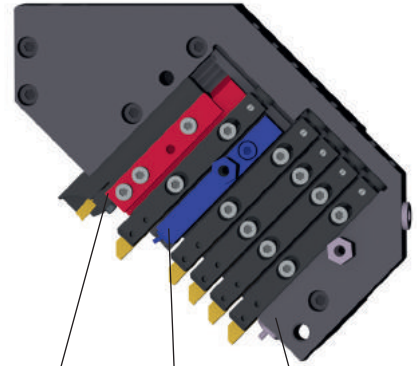
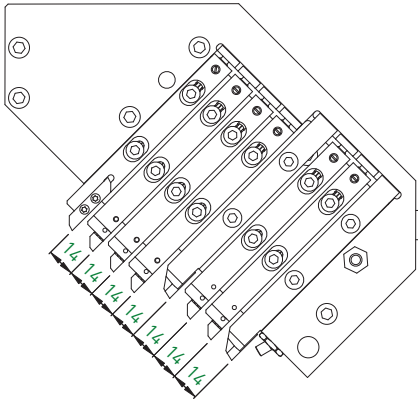

Outil  $\square$  12 mm possible avec module de serrage  
 Werkzeug  $\square$  12 mm mit Spannelement möglich  
 Tool  $\square$  12mm possible with clamping unit

Module d'arrosage (prend la place d'un outil)  
 Kühlmittelzufuhrelement (nimmt den Platz eines Werkzeuges)  
 Coolant supply unit (takes the place of one tool)

Arrosage intégré  
 Integrierter Kühlmittel  
 Integrated coolant

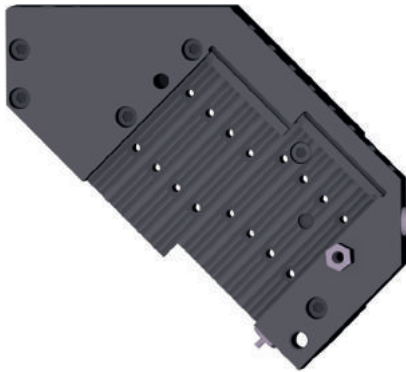

Accessoires  
 Zubehöre  
 Accessories

Art. N°	Porte-outils Halter Holders	Pages Seiten Pages	Module de serrage Spannelement Clamping unit	Module d'arrosage Kühlmittelzufuhrelement Coolant supply unit	Page Seite Page
ML12-CITIZEN-C16	ML12	> 12.63	<b>ML12-FIX-12/14</b>	<b>ML12-JET-5/16</b>	12.82

Citizen L12-1M7

- + 2 outils (max 8)
- + 2 Werkzeuge (max 8)
- + 2 tools (max 8)

ML12

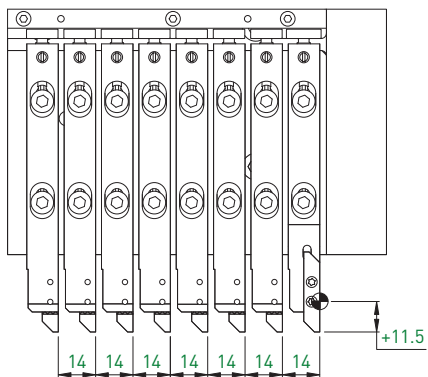

Accessoires  
Zubehöre  
Accessories

Art. N°	Porte-outils Halter Holders	Pages Seiten Pages	Module de serrage Spannelement Clamping unit	Module d'arrosage Kühlmitelzufuhrelement Coolant supply unit	Page Seite Page
ML12-CITIZEN-L12-1M7	ML12	> 12.63	-	<a href="#">ML12-JET-5/16</a>	12.82

**Citizen L12-2M10**

- + 3 outils (max 10)
- + 3 Werkzeuge (max 10)
- + 3 tools (max 10)

**ML12**

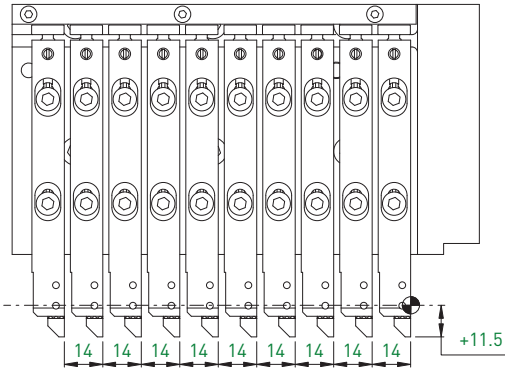

Accessoires  
Zubehöre  
Accessories

Art. N°	Porte-outils Halter Holders	Pages Seiten Pages	Module de serrage Spannelement Clamping unit	Module d'arrosage Kühlmittelzufuhrelement Coolant supply unit	Page Seite Page
ML12-CITIZEN-L12-2M10	ML12	> 12.63	-	<a href="#">ML12-JET-5/16</a>	12.82

Citizen M16 V/VIII

- + 2 outils (max 7)
- + 2 Werkzeuge (max 7)
- + 2 tools (max 7)

ML12

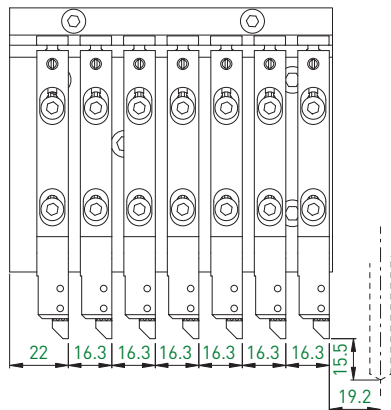

Accessoires  
Zubehöre  
Accessories

Art. N°	Porte-outils Halter Holders	Pages Seiten Pages	Module de serrage Spannelement Clamping unit	Module d'arrosage Kühlmittelzufuhrelement Coolant supply unit	Page Seite Page
ML12-CITIZEN-M16V/VIII	ML12	> 12.63	-	<a href="#">ML12-JET-5/16</a>	12.82

Citizen R04

- + 1 outil (max 8)
- + 1 Werkzeug (max 8)
- + 1 tool (max 8)

ML12

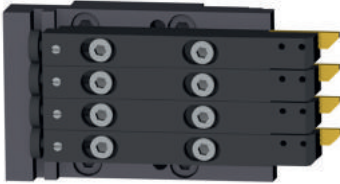
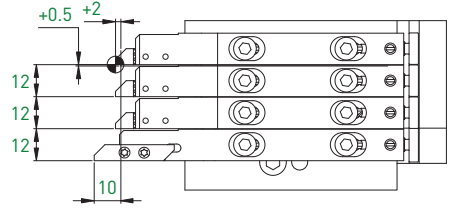
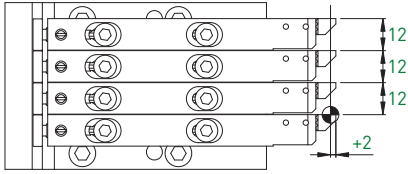

ML12-CITIZEN-R04-QTF5008-4T

ML12-CITIZEN-R04-QTF5108-4T

Type Typ Type	Art. N°	Porte-outils Halter Holders	Pages Seiten Pages	Module de serrage Spannelement Clamping unit	Module d'arrosage Kühlmittelzufuhrelement Coolant supply unit	Page Seite Page
4T	ML12-CITIZEN-R04-QTF5008-4T ML12-CITIZEN-R04-QTF5108-4T	ML12	> 12.63	-	ML12-JET-5/16	12.82

Accessoires  
Zubehöre  
Accessories



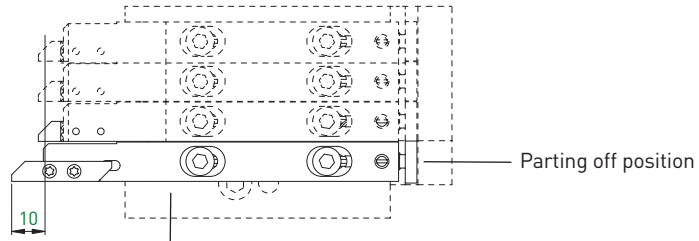

ML12-CITIZEN-R04-QTF5108-4T

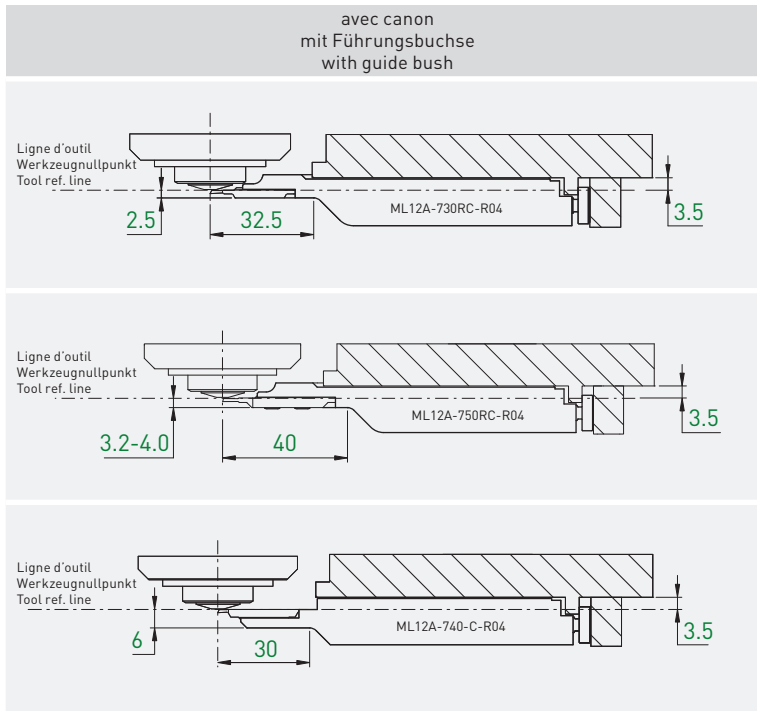

Type de machine Maschinen-Typ Type of machine	Porte-outils Halter Holders	Art. N°	Plaquettes Wendepplatten Inserts	Pages Seiten Pages
Citizen R04	ML12	ML12A-730RC-R04	731R... / 731RSF	> TOP-Line TOP-Watch
		ML12A-750RC-R04	751R... / 751RDSF	
		ML12A-740-C-R04	741 / 741SF	

Citizen R04

- + 3 outils (max 3)
- + 3 Werkzeuge (max 3)
- + 3 tools (max 3)

ML12

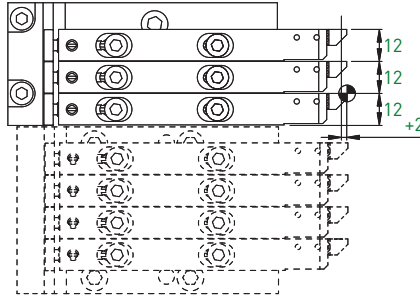

Accessoires  
Zubehöre  
Accessories

Art. N°	Porte-outils Halter Holders	Pages Seiten Pages	Module de serrage Spannelement Clamping unit	Module d'arrosage Kühlmitelzufuhrelement Coolant supply unit	Page Seite Page
ML12-CITIZEN-R04-QTF3101-3T	ML12	> 12.63	-	<a href="#">ML12-JET-5/16</a>	12.82

Citizen R07

- + 1 outil (max 11)
- + 1 Werkzeug (max 11)
- + 1 tool (max 11)

ML12

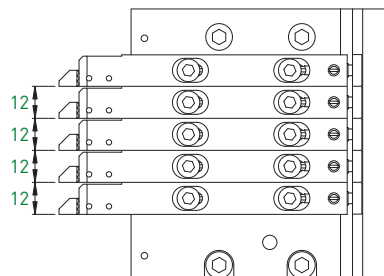
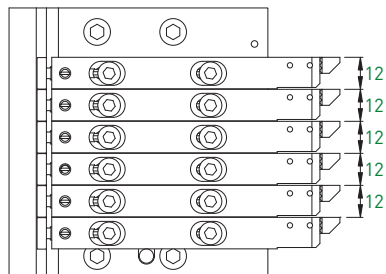

ML12-CITIZEN-R07-QTF4108-6T

ML12-CITIZEN-R07-QTF4008-5T

Type Typ Type	Art. N°	Porte-outils Halter Holders	Pages Seiten Pages	Module de serrage Spannelement Clamping unit	Module d'arrosage Kühlmittelzufuhrelement Coolant supply unit	Page Seite Page
5T	ML12-CITIZEN-R07-QTF4008-5T	ML12	> 12.63	-	ML12-JET-5/16	12.82
6T	ML12-CITIZEN-R07-QTF4108-6T					

Accessoires  
Zubehöre  
Accessories

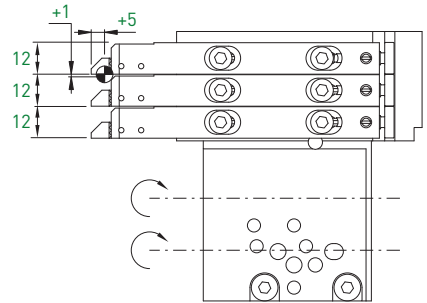
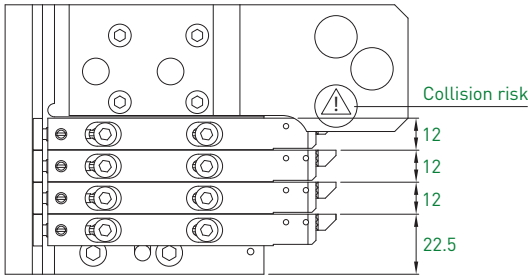

ML12-CITIZEN-R07-QTF4608-4T

ML12-CITIZEN-R07-QTF4208-3T

Type Typ Type	Art. N°	Porte-outils Halter Holders	Pages Seiten Pages	Module de serrage Spannelement Clamping unit	Accessoires Zubehöre Accessories	Page Seite Page
3T	ML12-CITIZEN-R07-QTF4208-3T	ML12	> 12.63	-	Module d'arrosage Kühlmittelzufuhrelement Coolant supply unit	ML12-JET-5/16
4T	ML12-CITIZEN-R07-QTF4608-4T					

Citizen K12 / K16  
K12E / K16E

+ 2 outils (max 8)  
+ 2 Werkzeuge (max 8)  
+ 2 tools (max 8)

ML16

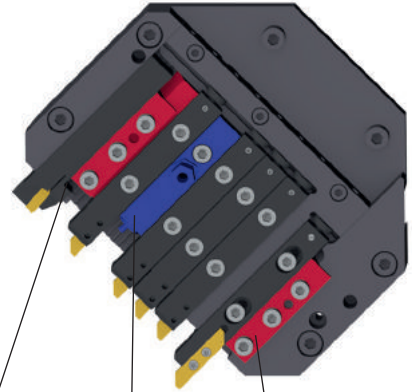
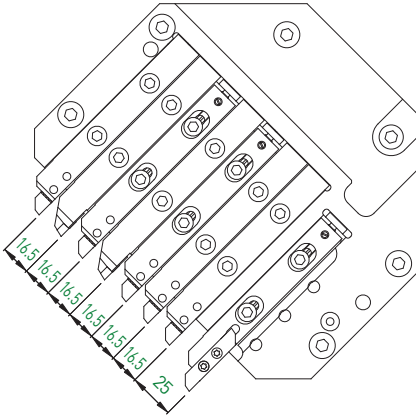

Outil  $\square$  16 mm possible avec module de serrage  
Werkzeug  $\square$  16 mm mit Spannelement möglich  
Tool  $\square$  16 mm possible with clamping unit

Module d'arrosage (prend la place d'un outil)  
Kühlmittelzufuhrelement (nimmt den Platz eines Werkzeuges)  
Coolant supply unit (takes the place of one tool)

1 serrage ML16-FIX-16 pour outil  $\square$  16 mm inclus  
1 Spannung ML16-FIX-16 für Werkzeug  $\square$  16 mm inbegriffen  
1 clamping ML16-FIX-16 for tool  $\square$  16 mm included

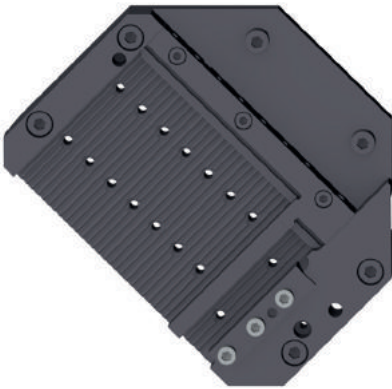

Accessoires  
Zubehöre  
Accessories

Art. N°	Porte-outils Halter Holders	Pages Seiten Pages	Module de serrage Spannelement Clamping unit	Module d'arrosage Kühlmittelzufuhrelement Coolant supply unit	Page Seite Page
ML16-CITIZEN-K16	ML16	> 12.63	<b>ML16-FIX-16/16.5</b>	<b>ML16-JET-7/16</b>	12.82

**Citizen L16 / L20-5M1 / 5M7**

- + 1 outil (max 7)
- + 1 Werkzeug (max 7)
- + 1 tool (max 7)

**ML16**

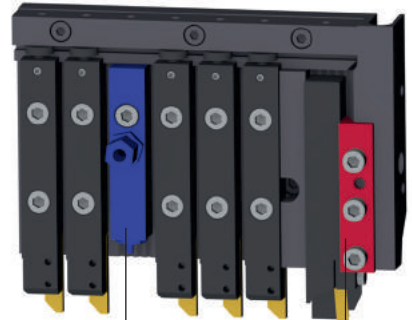
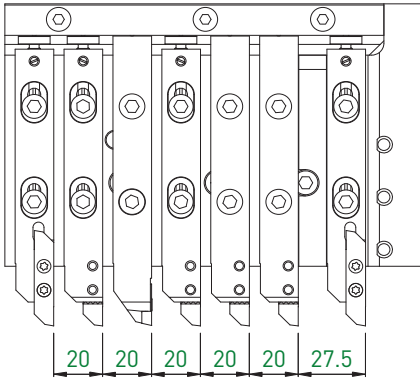

Module d'arrosage (prend la place d'un outil)  
 Kühlmittelzufuhrelement (nimmt den Platz eines Werkzeuges)  
 Coolant supply unit (takes the place of one tool)

- 1 serrage ML16-FIX-16 pour outil  $\varnothing$  16 mm inclus
- 1 Spannung ML16-FIX-16 für Werkzeug  $\varnothing$  16 mm inbegriffen
- 1 clamping ML16-FIX-16 for tool  $\varnothing$  16 mm included



Accessoires  
 Zubehör  
 Accessories

Art. N°	Porte-outils Halter Holders	Pages Seiten Pages	Module de serrage Spannelement Clamping unit	Module d'arrosage Kühlmittelzufuhrelement Coolant supply unit	Page Seite Page
ML16-CITIZEN-L20	ML16	> 12.63	-	<a href="#">ML16-JET-7/16</a>	12.82

- L20E-1M8** + 1 outil (max 6)
- Citizen L20X-1M10** + 1 Werkzeug (max 6)
- L20-2M8/2M12** + 1 tool (max 6)

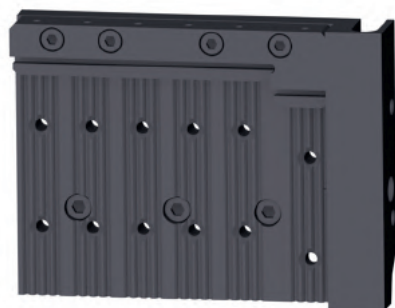
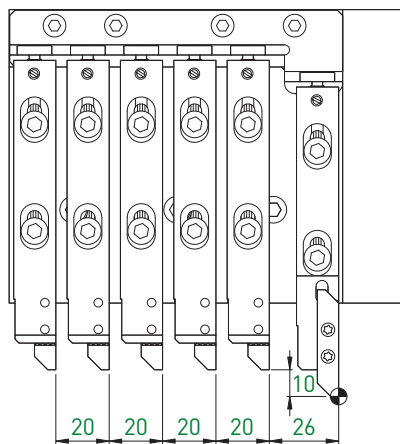

Accessoires  
Zubehöre  
Accessories

Art. N°	Porte-outils Halter Holders	Pages Seiten Pages	Module de serrage Spannelement Clamping unit	Module d'arrosage Kühlmitelzufuhrelement Coolant supply unit	Page Seite Page
ML16-CITIZEN-L20E	ML16	> 12.63	-	<a href="#">ML16-JET-7/16</a>	12.82

**Hanwha XD20M**

- + 2 outils (max 7)
- + 2 Werkzeuge (max 7)
- + 2 tools (max 7)

**ML12**

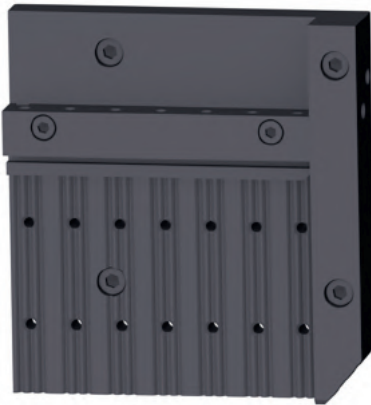
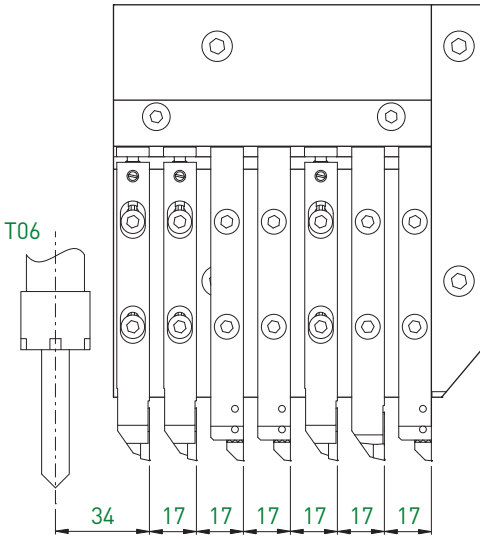

Accessoires  
Zubehöre  
Accessories

Art. N°	Porte-outils Halter Holders	Pages Seiten Pages	Module de serrage Spannelement Clamping unit	Module d'arrosage Kühlmittelzufuhrelement Coolant supply unit	Page Seite Page
ML12-HANWHA-XD20M	ML12	> 12.63	-	<a href="#">ML12-JET-5/16</a>	12.82



Hanwha SL12 / 16

- + 1 outil (max 7)
- + 1 Werkzeug (max 7)
- + 1 tool (max 7)

ML16

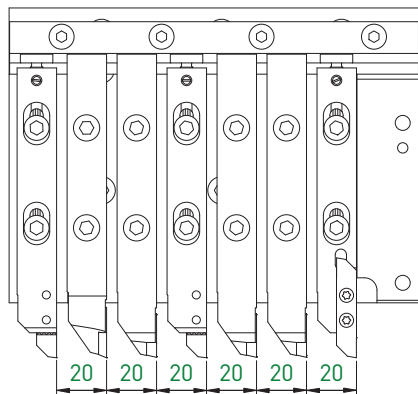

Accessoires  
Zubehöre  
Accessories

Art. N°	Porte-outils Halter Holders	Pages Seiten Pages	Module de serrage Spannelement Clamping unit	Module d'arrosage Kühlmitelzufuhrelement Coolant supply unit	Page Seite Page
ML16-HANWHA-SL12/16	ML16	> 12.63	-	<a href="#">ML16-JET-7/16</a>	12.82

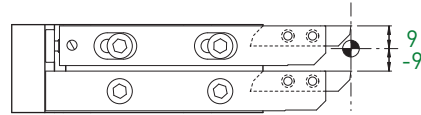
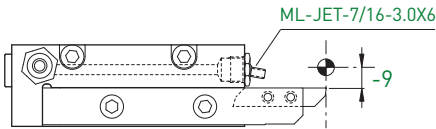
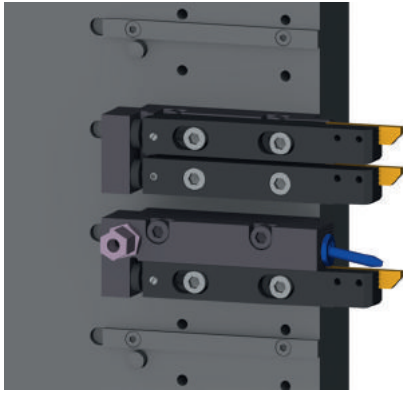

Jet



Duo

Accessoires  
Zubehöre  
Accessories

Type Typ Type	Art. N°	Porte-outils Halter Holders	Pages Seiten Pages	Module de serrage Spannelement Clamping unit	Module d'arrosage Kühlmittelzufuhrelement Coolant supply unit	Page Seite Page
Jet	<b>ML16-KMX26-JET</b>	ML16	> 12.63	-	<a href="#">ML-JET-7/16...</a>	12.82
Duo	<b>ML16-KMX26-DUO</b>				<a href="#">ML16-JET-7/16</a>	

D3	+ 1 outil (max 3)	<b>ML12</b>
Metafil D10	+ 1 Werkzeug (max 3)	
D13	+ 1 tool (max 3)	

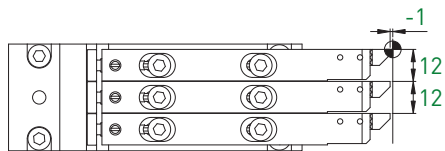

Accessoires  
Zubehöre  
Accessories

Art. N°	Porte-outils Halter Holders	Pages Seiten Pages	Module de serrage Spannelement Clamping unit	Module d'arrosage Kühlmittelzufuhrelement Coolant supply unit	Page Seite Page
ML12-D10-3T	ML12	> 12.63	-	<a href="#">ML12-JET-5/16</a>	12.82

**Star SB-12RG**

- + 2 outils (max 9)
- + 2 Werkzeuge (max 9)
- + 2 tools (max 9)

**ML12**

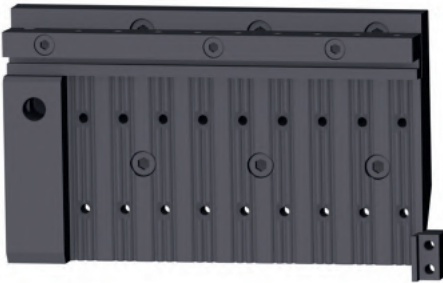
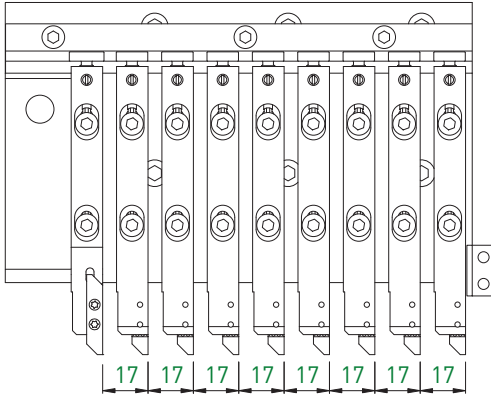

			Accessoires Zubehöre Accessories		
Art. N°	Porte-outils Halter Holders	Pages Seiten Pages	Module de serrage Spannelement Clamping unit	Module d'arrosage Kühlmittelzufuhrelement Coolant supply unit	Page Seite Page
<b>ML12-STAR-SB-12RG</b>	ML12	> 12.63	-	<a href="#">ML12-JET-5/16</a>	12.82

Star SR-10J

- + 2 outils (max 8)
- + 2 Werkzeuge (max 8)
- + 2 tools (max 8)

ML12

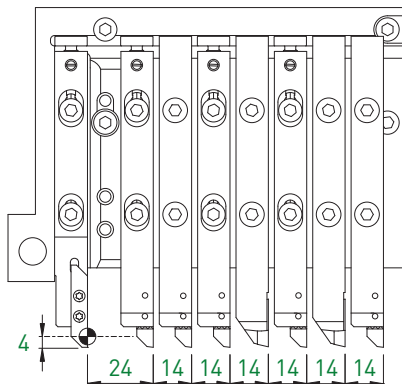

- 1 serrage ML12-FIX-12 pour outil  $\square$  12 mm inclus
- 1 Spannung ML12-FIX-12 für Werkzeug  $\square$  12 mm inbegriffen
- 1 clamping ML12-FIX-12 for tool  $\square$  12 mm included

Module d'arrosage (prend la place d'un outil)  
 Kühlmittelzufuhrelement (nimmt den Platz eines Werkzeuges)  
 Coolant supply unit (takes the place of one tool)



Accessoires  
 Zubehör  
 Accessories

Art. N°	Porte-outils Halter Holders	Pages Seiten Pages	Module de serrage Spannelement Clamping unit	Module d'arrosage Kühlmittelzufuhrelement Coolant supply unit	Page Seite Page
ML12-STAR-SR-10J	ML12	> 12.63	ML12-FIX-12/14	ML12-JET-5/16	12.82

**Star SW-12RII**

+ 2 outils (max 10)  
 + 2 Werkzeuge (max 10)  
 + 2 tools (max 10)

**ML12**

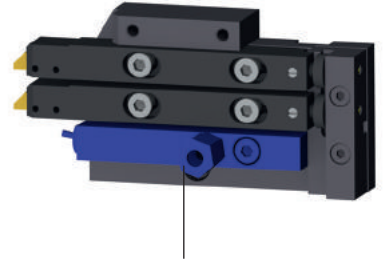
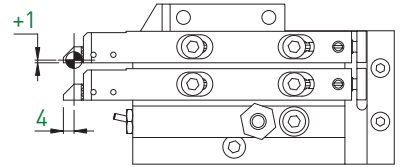
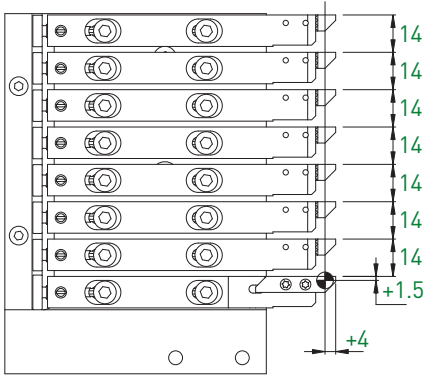

Position uniquement utilisable avec module d'arrosage, en option  
 Position nur mit Kühlmittelzufuhrelement verwendbar, optional  
 Position only with coolant supply unit usable, optional

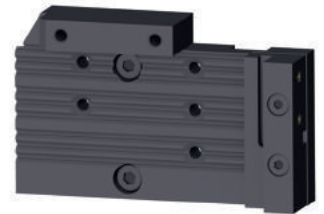

ML12-STAR-SW-12RII-8T

ML12-STAR-SW-12RII-2T

Accessoires  
 Zubehör  
 Accessories

Type Typ Type	Art. N°	Porte-outils Halter Holders	Pages Seiten Pages	Module de serrage Spannelement Clamping unit	Module d'arrosage Kühlmittelzufuhrelement Coolant supply unit	Page Seite Page
2T	<b>ML12-STAR-SW-12RII-2T</b>	ML12	> 12.63	-	<b>ML12-JET-5/16</b>	12.82
8T	<b>ML12-STAR-SW-12RII-8T</b>					

- SA-12 + 2 outils (max 8)
- Star SA-16 + 2 Werkzeuge (max 8)
- SA-16R + 2 tools (max 8)

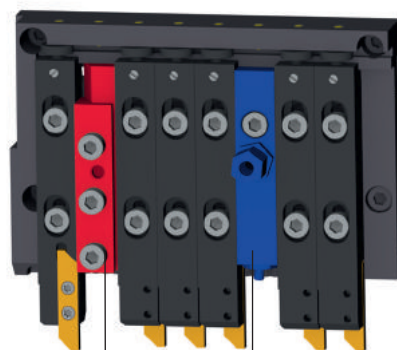
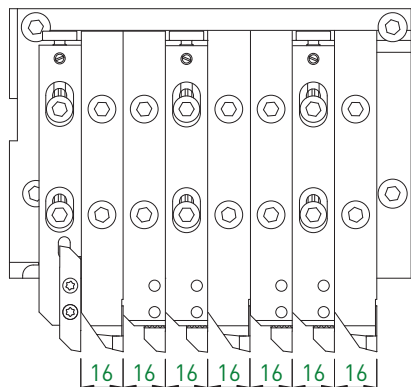

Outil 16 mm possible avec module de serrage  
 Werkzeug 16 mm mit Spannelement möglich  
 Tool 16 mm possible with clamping unit

Module d'arrosage (prend la place d'un outil)  
 Kühlmittelzufuhrelement (nimmt den Platz eines Werkzeuges)  
 Coolant supply unit (takes the place of one tool)

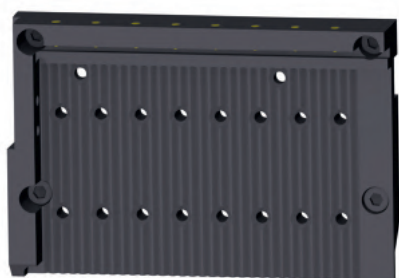

Accessoires  
 Zubehör  
 Accessories

Art. N°	Porte-outils Halter Holders	Pages Seiten Pages	Module de serrage Spannelement Clamping unit	Module d'arrosage Kühlmittelzufuhrelement Coolant supply unit	Page Seite Page
ML16-STAR-SA-16	ML16	> 12.63	ML16-FIX-16/16	ML16-JET-7/16	12.82

**Star SB-16**

- + 3 outils (max 8)
- + 3 Werkzeuge (max 8)
- + 3 tools (max 8)

**ML16**

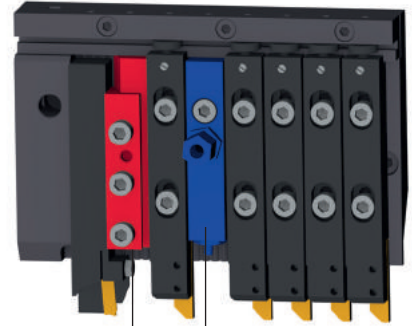
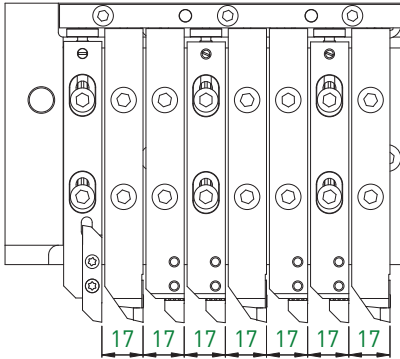

Outil  $\square$  16 mm possible avec module de serrage  
 Werkzeug  $\square$  16 mm mit Spannelement möglich  
 Tool  $\square$  16 mm possible with clamping unit

Module d'arrosage (prend la place d'un outil)  
 Kühlmittelzufuhrelement (nimmt den Platz eines Werkzeuges)  
 Coolant supply unit (takes the place of one tool)



Accessoires  
 Zubehöre  
 Accessories

Art. N°	Porte-outils Halter Holders	Pages Seiten Pages	Module de serrage Spannelement Clamping unit	Module d'arrosage Kühlmittelzufuhrelement Coolant supply unit	Page Seite Page
ML16-STAR-SB-16	ML16	> 12.63	<b>ML16-FIX-16/17</b>	<b>ML16-JET-7/16</b>	12.82



Star SB-16/20RG

- + 1 outil (max 7)
- + 1 Werkzeug (max 7)
- + 1 tool (max 7)

ML16

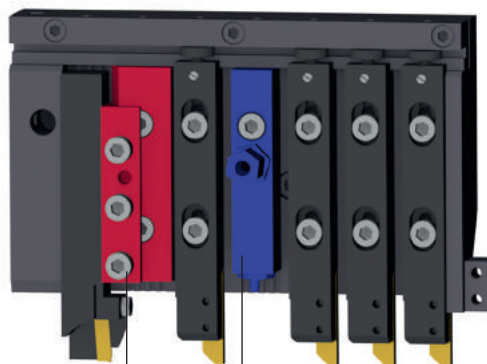
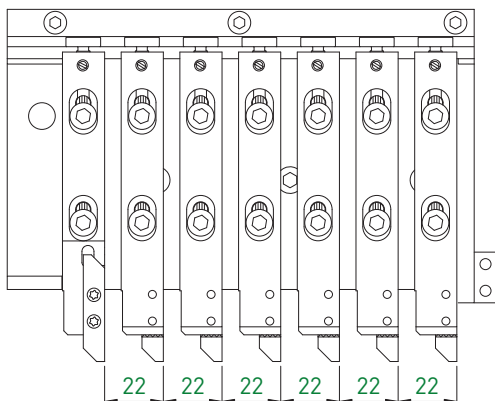

Outil  $\square$  16 mm possible avec module de serrage  
 Werkzeug  $\square$  16 mm mit Spannelement möglich  
 Tool  $\square$  16 mm possible with clamping unit

Module d'arrosage (prend la place d'un outil)  
 Kühlmittelzufuhrelement (nimmt den Platz eines Werkzeuges)  
 Coolant supply unit (takes the place of one tool)



Accessoires  
 Zubehör  
 Accessories

Art. N°	Porte-outils Halter Holders	Pages Seiten Pages	Module de serrage Spannelement Clamping unit	Module d'arrosage Kühlmittelzufuhrelement Coolant supply unit	Page Seite Page
ML16-STAR-SB-16/20RG	ML16	> 12.63	<b>ML16-FIX-16/22</b>	<b>ML16-JET-7/16</b>	12.82

Star SB-20C/E

- + 1 outil (max 7)
- + 1 Werkzeug (max 7)
- + 1 tool (max 7)

ML16

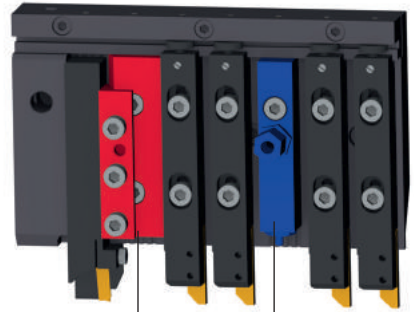
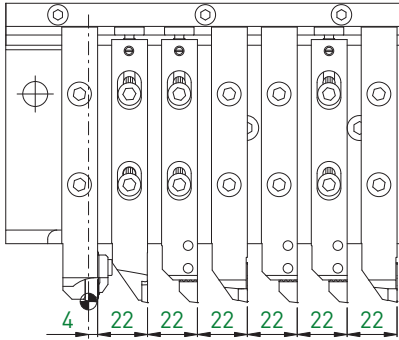

Outil  $\square$  16 mm possible avec module de serrage  
 Werkzeug  $\square$  16 mm mit Spannelement möglich  
 Tool  $\square$  16 mm possible with clamping unit

Module d'arrosage (prend la place d'un outil)  
 Kühlmittelzufuhrelement (nimmt den Platz eines Werkzeuges)  
 Coolant supply unit (takes the place of one tool)



Accessoires  
 Zubehöre  
 Accessories

Art. N°	Porte-outils Halter Holders	Pages Seiten Pages	Module de serrage Spannelement Clamping unit	Module d'arrosage Kühlmittelzufuhrelement Coolant supply unit	Page Seite Page
ML16-STAR-SB20C/E	ML16	> 12.63	ML16-FIX-16/22	ML16-JET-7/16	12.82

- SR-16R** + 3 outils (max 9)
- Star SR-20R** + 3 Werkzeuge (max 9)
- SR-20RII** + 3 tools (max 9)

**ML16**

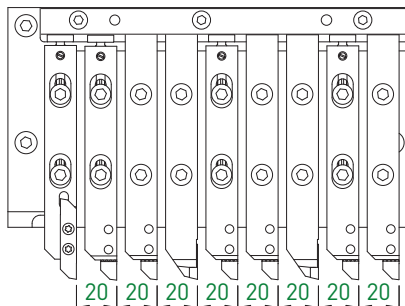

Outil 16 mm possible avec module de serrage  
 Werkzeug 16 mm mit Spannelement möglich  
 Tool 16 mm possible with clamping unit

Module d'arrosage (prend la place d'un outil)  
 Kühlmittelzufuhrelement (nimmt den Platz eines Werkzeuges)  
 Coolant supply unit (takes the place of one tool)



Accessoires  
 Zubehör  
 Accessories

Art. N°	Porte-outils Holder Holders	Pages Seiten Pages	Module de serrage Spannelement Clamping unit	Module d'arrosage Kühlmittelzufuhrelement Coolant supply unit	Page Seite Page
ML16-STAR-SR-20R	ML16	> 12.63	<b>ML16-FIX-16/20</b>	<b>ML16-JET-7/16</b>	12.82

# MODU-LINE

Star **SR-20RIII**  
**SR-20J**

+ 3 outils (max 9)  
+ 3 Werkzeuge (max 9)  
+ 3 tools (max 9)

**ML16**

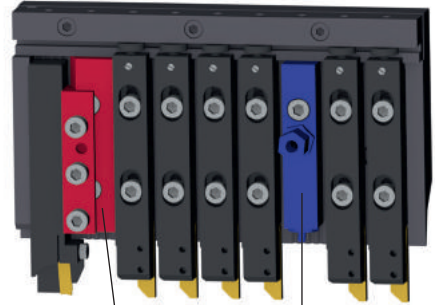
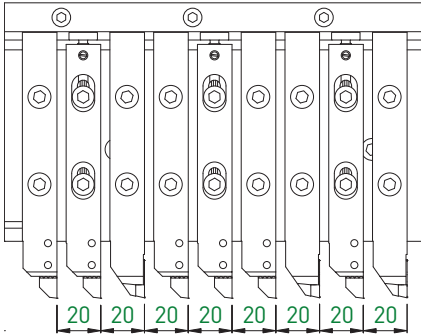

Outil 16 mm possible avec module de serrage  
Werkzeug 16 mm mit Spannelement möglich  
Tool 16 mm possible with clamping unit

Module d'arrosage (prend la place d'un outil)  
Kühlmittelzufuhrelement (nimmt den Platz eines Werkzeuges)  
Coolant supply unit (takes the place of one tool)

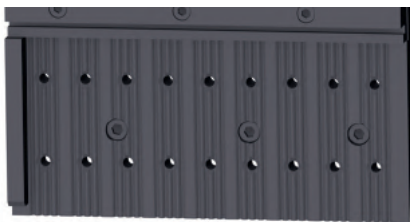

Art. N°	Porte-outils Halter Holders	Pages Seiten Pages	Accessoires Zubehöre Accessories		
			Module de serrage Spannelement Clamping unit	Module d'arrosage Kühlmittelzufuhrelement Coolant supply unit	Page Seite Page
ML16-STAR-SR-20RIII	ML16	> 12.63	<b>ML16-FIX-16/20</b>	<b>ML16-JET-7/16</b>	12.82
ML16-STAR-SR-20J					

Star SR20JII type A/B

- + 3 outils (max 9)
- + 3 Werkzeuge (max 9)
- + 3 tools (max 9)

ML16

**new**

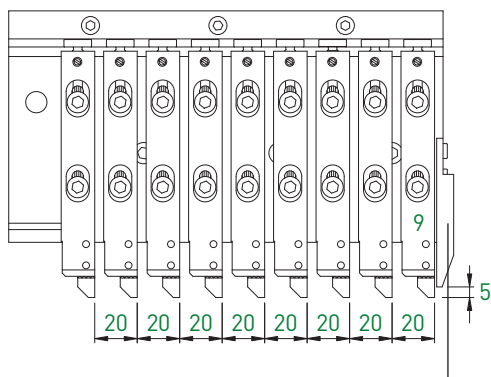

Risque de collision avec outil 9  
 Kollisionsrisiko mit Werkzeug 9  
 Collision risk with tool 9



Accessoires  
 Zubehöre  
 Accessories

Art. N°	Porte-outils Halter Holders	Pages Seiten Pages	Module de serrage Spannelement Clamping unit	Module d'arrosage Kühlmittelzufuhrelement Coolant supply unit	Page Seite Page
ML16-STAR-SR20JII-A/B	ML16	> 12.63	<b>ML16-FIX-16/20</b>	<b>ML16-JET-7/16</b>	12.82

**Star SR-20RIV**

- + 1 outil (max 8)
- + 1 Werkzeug (max 8)
- + 1 tool (max 8)

**ML16**

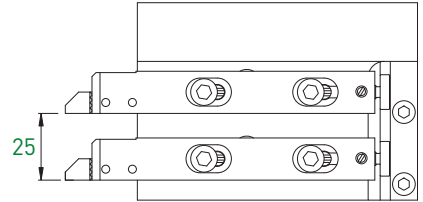
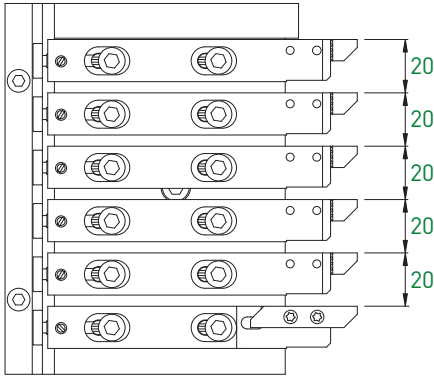

ML16-STAR-SR-20RIV-6T

ML16-STAR-SR-20RIV-2T

Type Typ Type	Art. N°	Porte-outils Halter Holders	Pages Seiten Pages	Module de serrage Spannelement Clamping unit	Accessoires Zubehöre Accessories	Page Seite Page
2T	<b>ML16-STAR-SR-20RIV-2T</b>	ML16	> 12.63	-	Module d'arrosage Kühlmittelezufuhrelement Coolant supply unit	<b>ML16-JET-7/16</b>
6T	<b>ML16-STAR-SR-20RIV-6T</b>					

**Star SR-32J**     $\varnothing$  max 32 mm    + 1 outil (max 7)  
 + 1 Werkzeug (max 7)  
 + 1 tool (max 7)

$\varnothing$  max 16 mm    + 7 outils (max 13)  
 + 7 Werkzeuge (max 13)    **ML16**  
 + 7 tools (max 13)

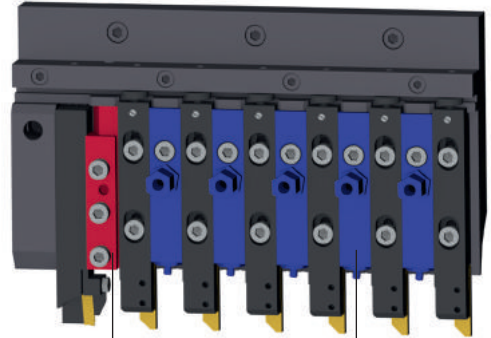
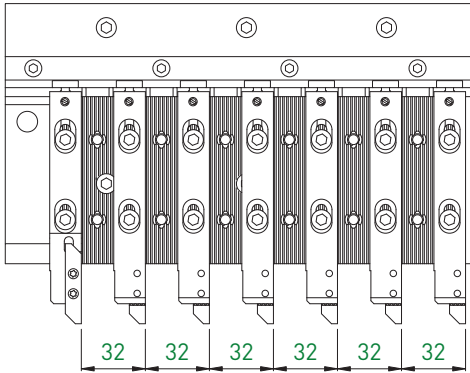

Outil  $\varnothing$  16 mm possible avec module de serrage  
 Werkzeug  $\varnothing$  16 mm mit Spannelement möglich  
 Tool  $\varnothing$  16 mm possible with clamping unit

Module d'arrosage (prend la place d'un outil)  
 Kühlmittelzufuhrelement (nimmt den Platz eines Werkzeuges)  
 Coolant supply unit (takes the place of one tool)

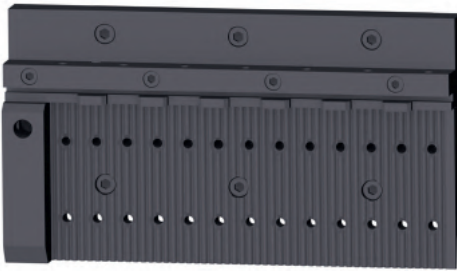

			Accessoires Zubehöre Accessories		
Art. N°	Porte-outils Halter Holders	Pages Seiten Pages	Module de serrage Spannelement Clamping unit	Module d'arrosage Kühlmittelzufuhrelement Coolant supply unit	Page Seite Page
ML16-STAR-SR-32J	ML16	> 12.63	<b>ML16-FIX-16/16</b>	<b>ML16-JET-7/16</b>	12.82

Star SV-12 / 20

+ 2 outils (max 7)  
 + 2 Werkzeuge (max 7)  
 + 2 tools (max 7)

ML16

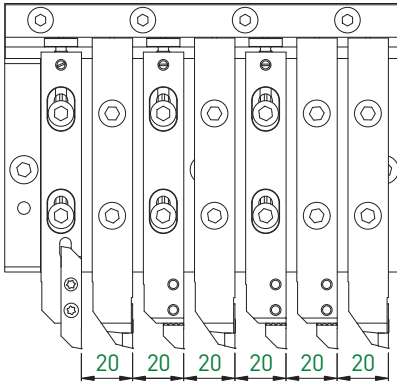

Outil  $\nabla$  16 mm possible avec module de serrage  
 Werkzeug  $\nabla$  16 mm mit Spannelement möglich  
 Tool  $\nabla$  16 mm possible with clamping unit

Module d'arrosage (prend la place d'un outil)  
 Kühlmittelzufuhrelement (nimmt den Platz eines Werkzeugs)  
 Coolant supply unit (takes the place of one tool)

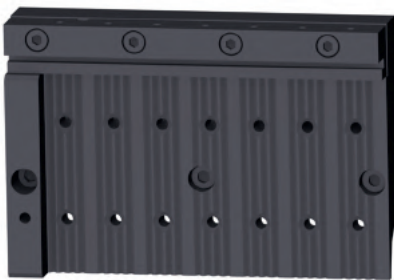

Accessoires  
 Zubehör  
 Accessories

Art. N°	Porte-outils Halter Holders	Pages Seiten Pages	Module de serrage Spannelement Clamping unit	Module d'arrosage Kühlmittelzufuhrelement Coolant supply unit	Page Seite Page
ML16-STAR-SV-12/20	ML16	> 12.63	ML16-FIX-16/20	ML16-JET-7/16	12.82



Star SV-20R

- + 2 outils (max 9)
- + 2 Werkzeuge (max 9)
- + 2 tools (max 9)

ML16

**new**

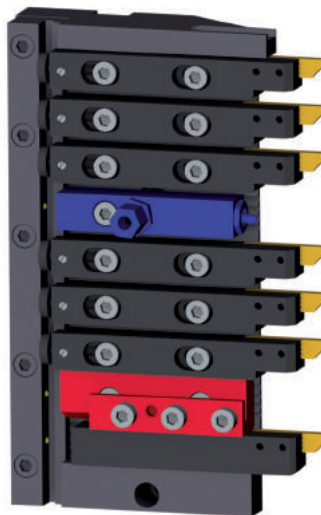
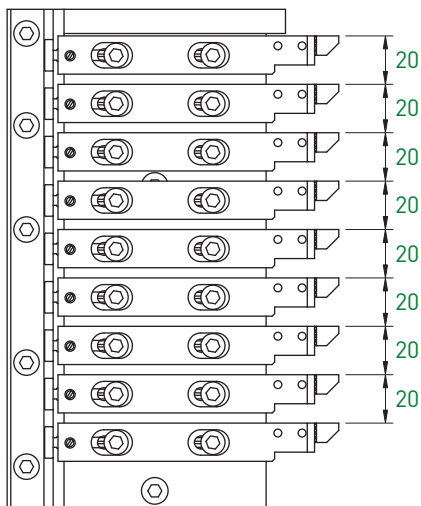

Accessoires  
Zubehöre  
Accessories

Art. N°	Porte-outils Halter Holders	Pages Seiten Pages	Module de serrage Spannelement Clamping unit	Module d'arrosage Kühlmitelzufuhrelement Coolant supply unit	Page Seite Page
ML16-STAR-SV-20R	ML16	> 12.63	<b>ML16-FIX-16/20</b>	<b>ML16-JET-7/16</b>	12.82

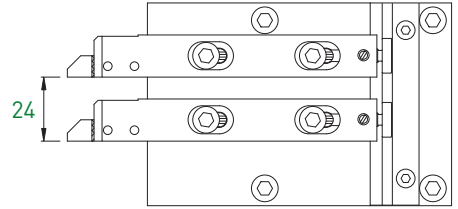
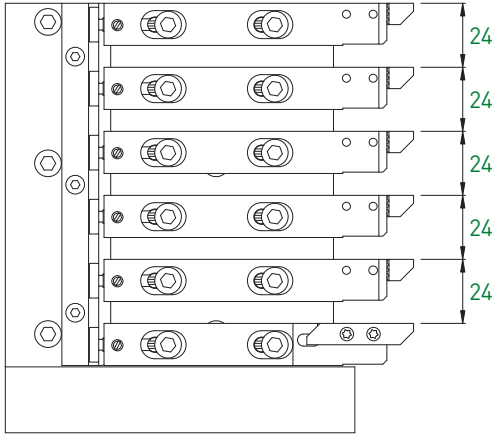

ML16-STAR-SW-20R-6T

ML16-STAR-SW-20R-2T

Accessoires  
 Zubehöre  
 Accessories

Type Typ Type	Art. N°	Porte-outils Halter Holders	Pages Seiten Pages	Module de serrage Spannelement Clamping unit	Module d'arrosage Kühlmittelezufuhrelement Coolant supply unit	Page Seite Page
2T	<b>ML16-STAR-SW-20R-2T</b>	ML16	> 62	-	<b>ML16-JET-7/16</b>	12.82
6T	<b>ML16-STAR-SW-20R-6T</b>			<b>ML16-FIX-16/24</b>		

Jet

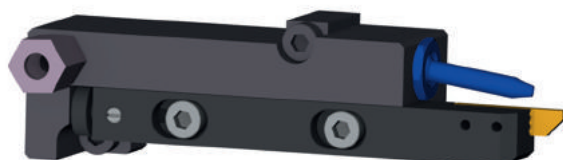

Duo

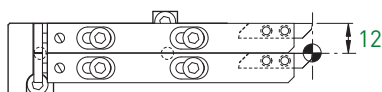
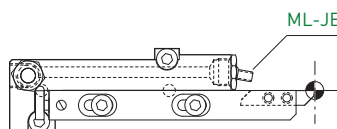
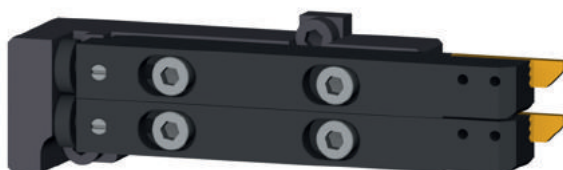

Jet



Duo

Type Typ Type	Art. N°	Porte-outils Halter Holders	Pages Seiten Pages	Module de serrage Spannelement Clamping unit	Accessoires Zubehöre Accessories	Module d'arrosage Kühlmittelezufuhrelement Coolant supply unit	Page Seite Page
Jet	ML12-DEC010-JET	ML12	> 12.63	-		ML-JET-7/16...	12.82
Duo	ML12-DEC010-DUO					ML12-JET-5/16	

Tornos **SwissNano**  
**SwissNano 7**

+ 2 outils (max 6)  
+ 2 Werkzeuge (max 6)  
+ 2 tools (max 6)

ML12

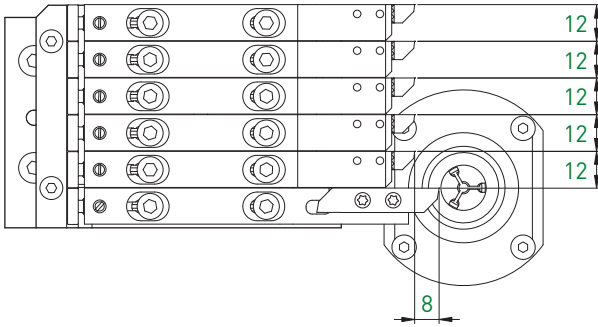

6T



6T

Accessoires  
Zubehöre  
Accessories

Type Typ Type	Art. N°	Porte-outils Halter Holders	Pages Seiten Pages	Module de serrage Spannelement Clamping unit	Module d'arrosage Kühlmittelfzufuhrelement Coolant supply unit	Page Seite Page
6T	ML12-SWISS-NANO-6T	ML12	> 12.63	-	<a href="#">ML12-JET-5/16</a>	12.82

Tornos **SwissNano**  
**SwissNano 7**

ML12

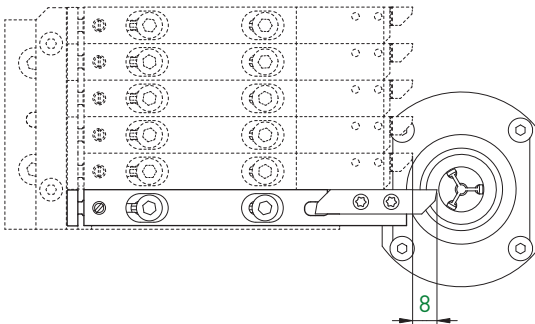

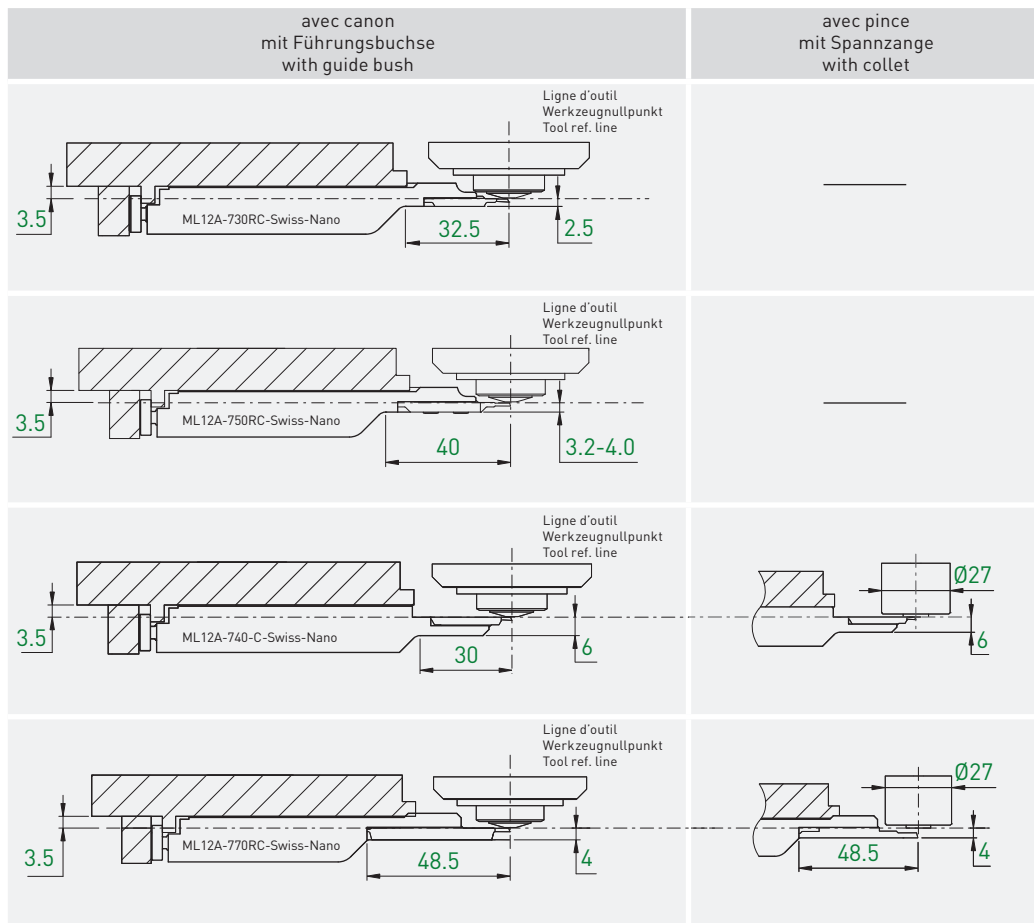

Type de machine Maschinen-Typ Type of machine	Porte-outils Halter Holders	Art. N°	Plaquettes Wendepplatten Inserts	Pages Seiten Pages
SwissNano	ML12	ML12A-730RC-SWISS-NANO	731R... / 731RSF	> TOP-Line TOP-Watch
		ML12A-750RC-SWISS-NANO	751R... / 751RDSF	
		ML12A-740-C-SWISS-NANO	741... / 741SF	> TOP-Line
		ML12A-770RC-SWISS-NANO	771R...	

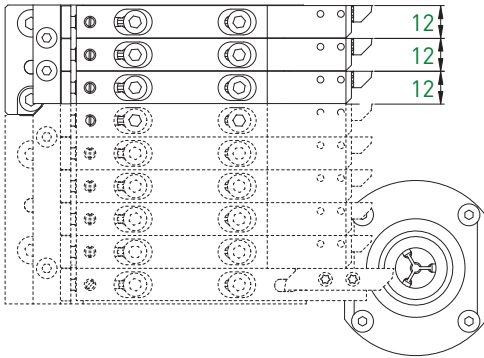
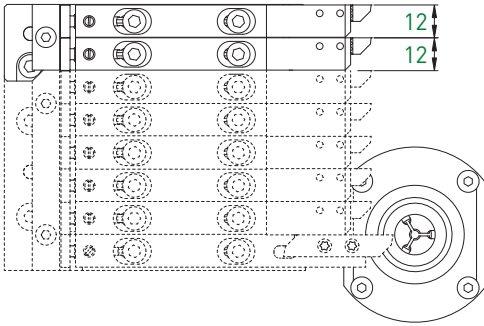

Accessoires  
Zubehöre  
Accessories

Type Typ Type	Art. N°	Porte-outils Halter Holders	Pages Seiten Pages	Module de serrage Spannelement Clamping unit	Module d'arrosage Kühlmittelzufuhrelement Coolant supply unit	Page Seite Page
2T	<b>ML12-SWISS-NANO-2T</b>	ML12	> 12.63	-	<b>ML12-JET-5/16</b>	12.82
3T	<b>ML12-SWISS-NANO-3T</b>					

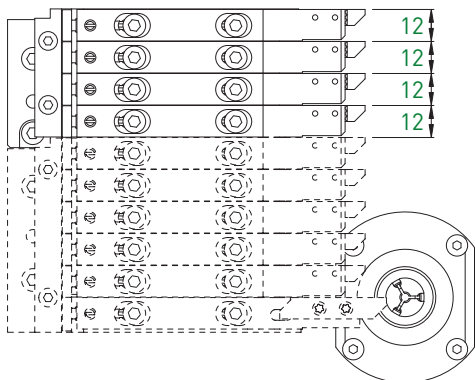

Type Typ Type	Art. N°	Porte-outils Halter Holders	Pages Seiten Pages	Accessoires Zubehöre Accessories		
				Module de serrage Spannelement Clamping unit	Module d'arrosage Kühlmittelelement Coolant supply unit	Page Seite Page
4T	ML12-SWISS-NANO-7-4T	ML12	> 12.63	-	ML12-JET-5/16	12.82

**Tornos DT 13**

+ 3 outils (max 9)  
 + 3 Werkzeuge (max 9)  
 + 3 tools (max 9)

**ML12**

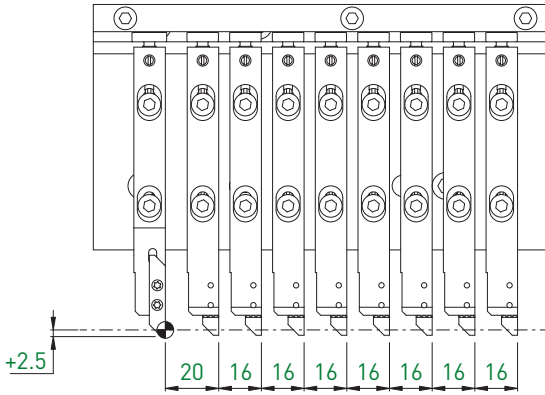

Accessoires  
 Zubehör  
 Accessories

Type Typ Type	Art. N°	Porte-outils Halter Holders	Pages Seiten Pages	Module de serrage Spannelement Clamping unit	Module d'arrosage Kühlmittelzufuhrelement Coolant supply unit	Page Seite Page
9T	<b>ML12-DT13-2020206-9T</b>	ML12	> 12.63	-	<b>ML12-JET-5/16</b>	12.82



**Tornos CT 20**

- + 1 outil (max 7)
- + 1 Werkzeug (max 7)
- + 1 tool (max 7)

**ML12**

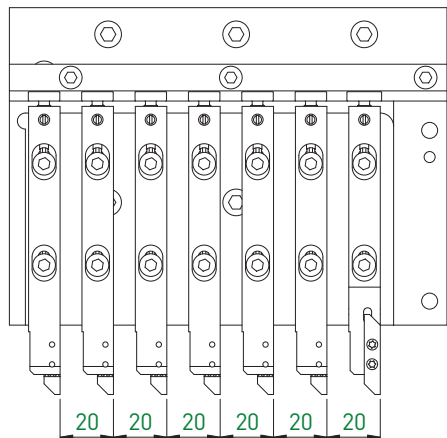

Accessoires  
Zubehöre  
Accessories

Type Typ Type	Art. N°	Porte-outils Halter Holders	Pages Seiten Pages	Module de serrage Spannelement Clamping unit	Module d'arrosage Kühlmitelzufuhrelement Coolant supply unit	Page Seite Page
7T	ML12-CT20-2020019-7T	ML12	> 12.63	-	ML12-JET-5/16	12.82

Tornos GT 13

+ 5 outils (max 12)  
+ 5 Werkzeuge (max 12)  
+ 5 tools (max 12)

ML12

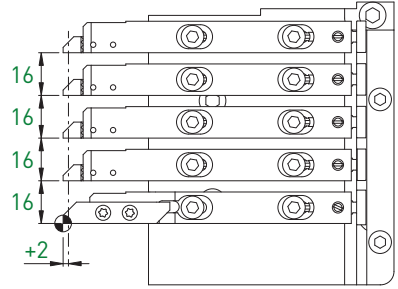
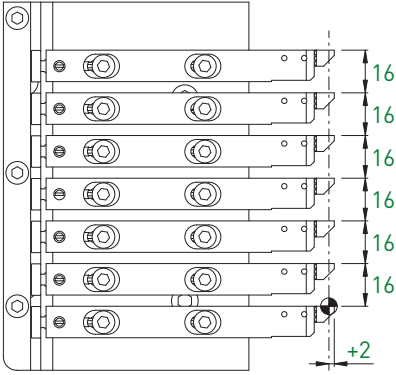



ML12-GT13-390223-7T



ML12-GT13-390224-5T

Type Typ Type	Art. N°	Porte-outils Halter Holders	Pages Seiten Pages	Accessoires Zubehöre Accessories		
				Module de serrage Spannelement Clamping unit	Module d'arrosage Kühlmitelzufuhrelement Coolant supply unit	Page Seite Page
5T	<b>ML12-GT13-390224-5T</b>	ML12	> 12.63	-	<b>ML12-JET-5/16</b>	12.82
7T	<b>ML12-GT13-390223-7T</b>					

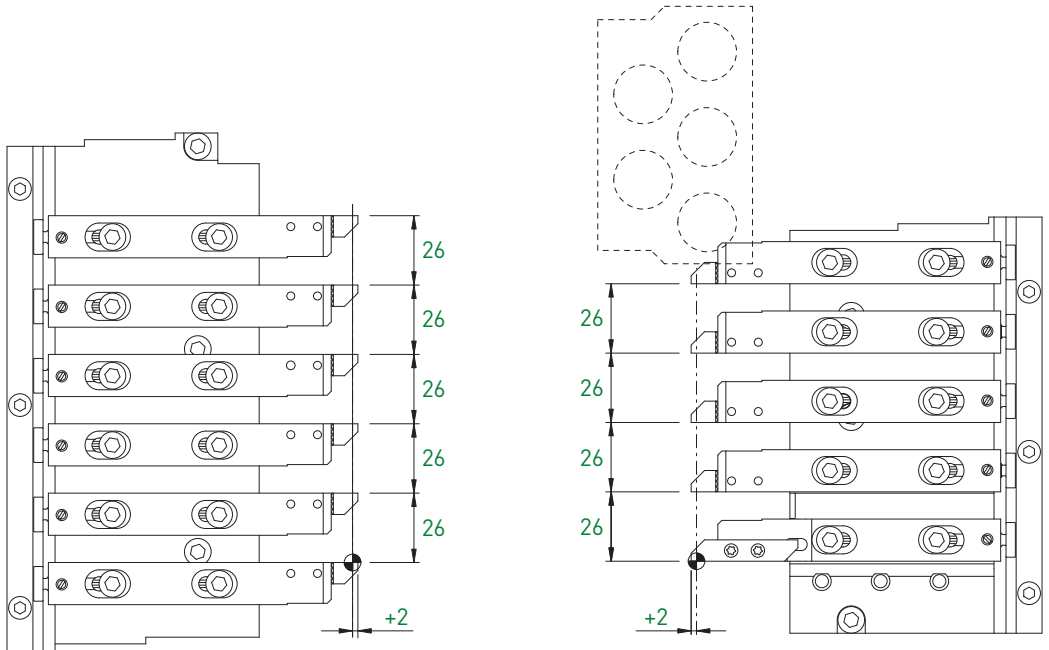

1 serrage ML16-FIX-16 pour outil  $\square$  16 mm inclus  
 1 Spannung ML16-FIX-16 für Werkzeug  $\square$  16 mm inbegriffen  
 1 clamping ML16-FIX-16 for tool  $\square$  16 mm included



ML16-GT26-386209-6T



ML16-GT26-386210-5T

Accessoires  
Zubehöre  
Accessories

Type Typ Type	Art. N°	Porte-outils Halter Holders	Pages Seiten Pages	Module de serrage Spannelement Clamping unit	Module d'arrosage Kühlmittelezufuhrelement Coolant supply unit	Page Seite Page
5T	<b>ML16-GT26-386210-5T</b>	ML16	> 12.63	-	<b>ML16-JET-7/16</b>	12.82
6T	<b>ML16-GT26-386209-6T</b>					

Tornos GT 32

+ 9 outils  
 max + 9 Werkzeuge  
 + 9 tools

ML16

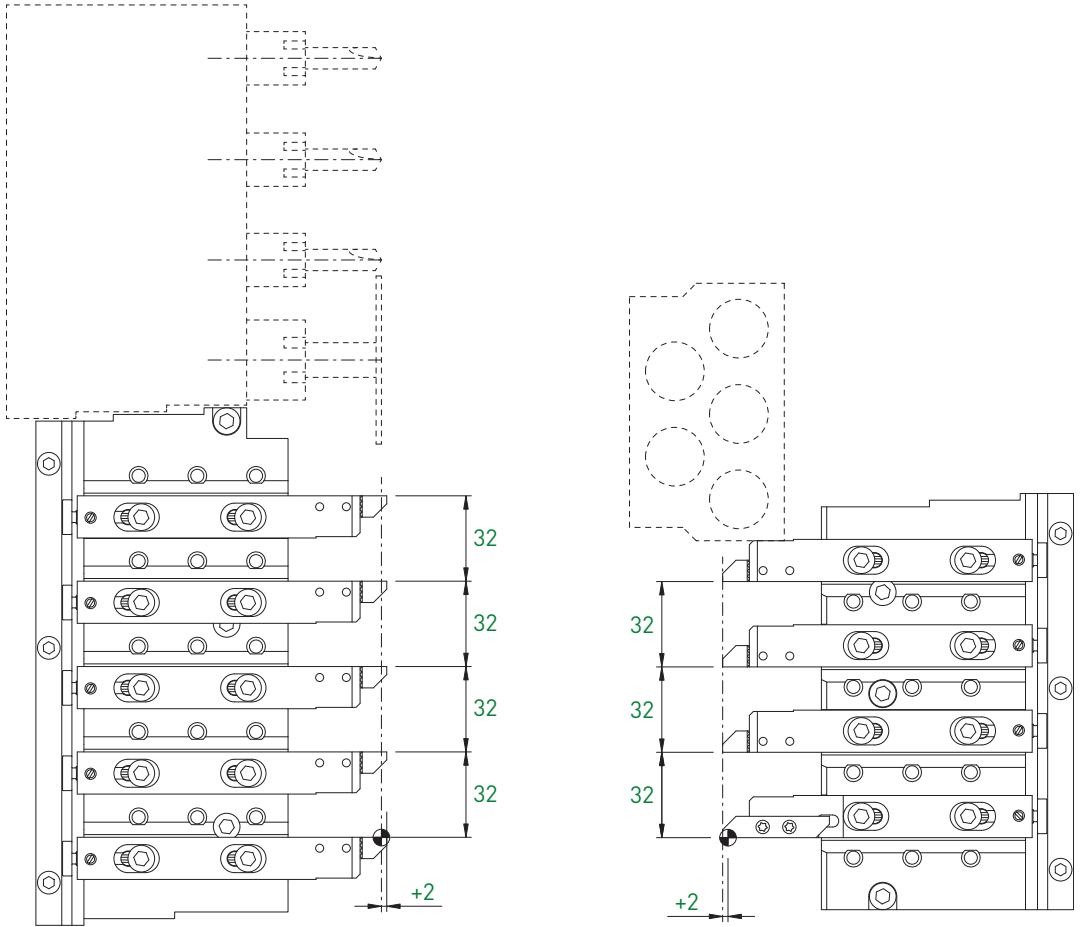

Holder ML16

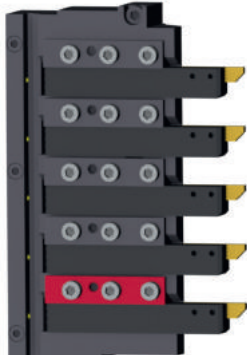

Holder □16



Holder ML16



Holder □16



ML16-GT32-386209-5T



ML16-GT32-386210-4T

				Accessoires Zubehöre Accessories			
Type Typ Type	Art. N°	Porte-outils Halter Holders	Pages Seiten Pages	Module de serrage Spannelement Clamping unit		Module d'arrosage Kühlmittelzufuhrelement Coolant supply unit	Pages Seiten Pages
4T	ML16-GT32-386210-4T	ML16	> 12.63	<b>1x inclus</b> <b>1x inbegriffen</b> <b>1x included</b>		ML16-JET-7/16	12.82
5T	ML16-GT32-386209-5T			<b>Option</b> <b>ML16-FIX-16</b>			

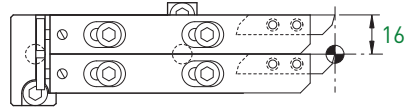
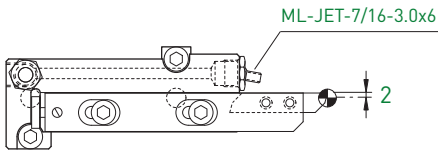

Jet



Duo

Accessoires  
Zubehöre  
Accessories

Type Typ Type	Art. N°	Porte-outils Halter Holders	Pages Seiten Pages	Module de serrage Spannelement Clamping unit	Module d'arrosage Kühlmittelezufuhrelement Coolant supply unit	Page Seite Page
Jet	<b>ML16-DEC013-JET</b>	ML16	> 12.63	-	<a href="#">ML-JET-7/16...</a>	12.82
Duo	<b>ML16-DEC013-DUO</b>				<a href="#">ML16-JET-7/16</a>	12.82



Jet



Duo

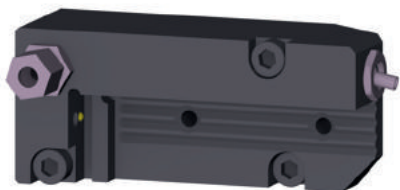
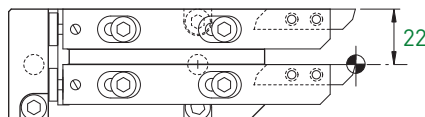
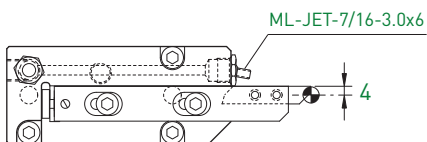

Jet



Duo

Accessoires  
Zubehöre  
Accessories

Type Typ Type	Art. N°	Porte-outils Halter Holders	Pages Seiten Pages	Module de serrage Spannelement Clamping unit	Module d'arrosage Kühlmittelzufuhrelement Coolant supply unit	Page Seite Page
Jet	<b>ML16-DECO20-JET</b>	ML16	> 12.63	-	<a href="#">ML-JET-7/16...</a>	12.82
Duo	<b>ML16-DECO20-DUO</b>				<a href="#">ML16-JET-7/16</a>	12.82

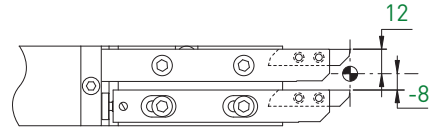
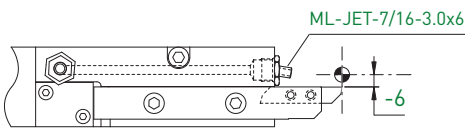
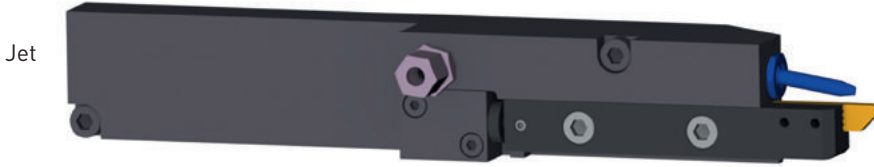

Jet



Duo

Accessoires  
Zubehöre  
Accessories

Type Typ Type	Art. N°	Porte-outils Halter Holders	Pages Seiten Pages	Module de serrage Spannelement Clamping unit	Module d'arrosage Kühlmittelezufuhrelement Coolant supply unit	Page Seite Page
Jet	ML16-S20-JET	ML16	> 12.63	-	ML-JET-7/16...	12.82
Duo	ML16-S20-DUO				ML16-JET-7/16	12.82

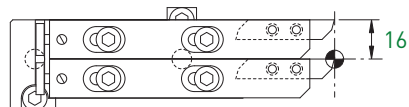
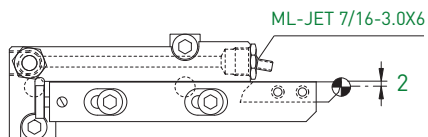
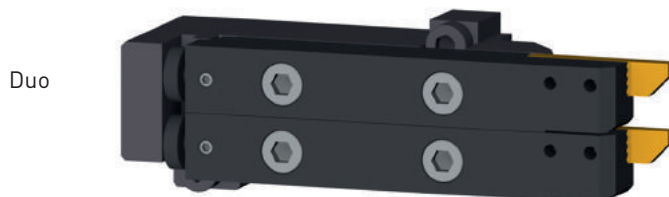

Jet

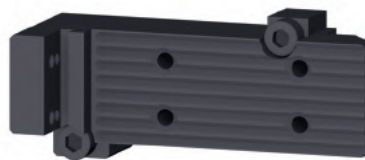

Duo

Type Typ Type	Art. N°	Porte-outils Halter Holders	Pages Seiten Pages	Module de serrage Spannelement Clamping unit	Accessoires Zubehöre Accessories	Page Seite Page
Jet	<b>ML16-SWISS-ST26-JET</b>	ML16	> 12.63	-	Module d'arrosage Kühlmittelezufuhrelement Coolant supply unit	12.82
Duo	<b>ML16-SWISS-ST26-DUO</b>				ML-JET-7/16...	12.82

**Tornos DT 26**

- + 1 outil (max 7)
- + 1 Werkzeug (max 7)
- + 1 tool (max 7)

**ML16**

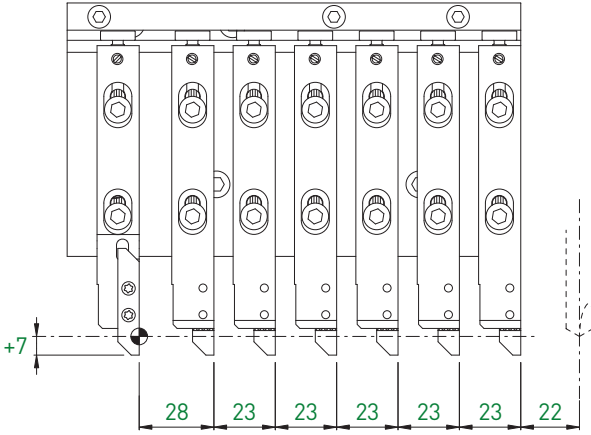

Accessoires  
Zubehöre  
Accessories

Type Typ Type	Art. N°	Porte-outils Halter Holders	Pages Seiten Pages	Module de serrage Spannelement Clamping unit	Module d'arrosage Kühlmittelzufuhrelement Coolant supply unit	Page Seite Page
7T	<b>ML16-DT26-2020206-7T</b>	ML16	> 12.63	-	<b>ML16-JET-7/16</b>	12.82

Tsugami B074

- + 3 outils (max 6)
- + 3 Werkzeuge (max 6)
- + 3 tools (max 6)

ML12

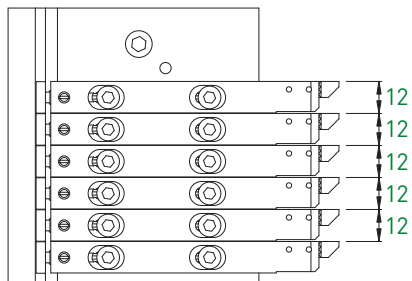

Type Typ Type	Art. N°	Porte-outils Halter Holders	Pages Seiten Pages	Accessoires Zubehöre Accessories		
				Module de serrage Spannelement Clamping unit	Module d'arrosage Kühlmittelezufuhrelement Coolant supply unit	Page Seite Page
6T	ML12-B074-1-6T	ML12	> 12.63	-	ML12-JET-5/16	12.82

**Tsugami B075**

- + 5 outils (max 8)
- + 5 Werkzeuge (max 8)
- + 5 tools (max 8)

**ML12**

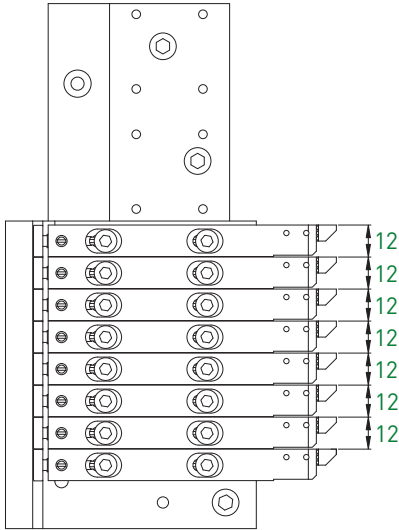

Type Typ Type	Art. N°	Porte-outils Halter Holders	Pages Seiten Pages	Accessoires Zubehöre Accessories		
				Module de serrage Spannelement Clamping unit	Module d'arrosage Kühlmittelzufuhrelement Coolant supply unit	Page Seite Page
8T	<b>ML12-B075-1-8T</b>	ML12	> 12.63	-	<b>ML12-JET-5/16</b>	12.82

Tsugami P034

- + 3 outils (max 9)
- + 3 Werkzeuge (max 9)
- + 3 tools (max 9)

ML12

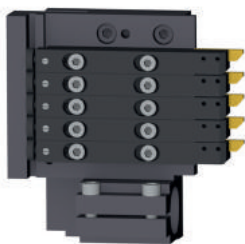
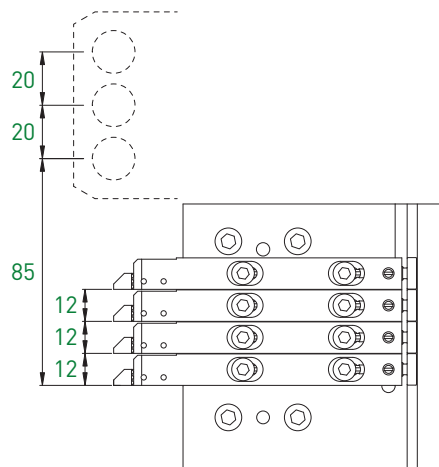
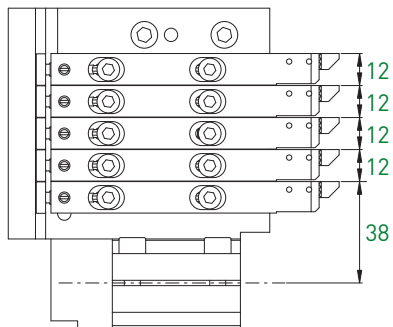

ML12-P034-1-5T

ML12-P034-2-4T

Type Typ Type	Art. N°	Porte-outils Halter Holders	Pages Seiten Pages	Module de serrage Spannelement Clamping unit	Module d'arrosage Kühlmittelzufuhrelement Coolant supply unit	Page Seite Page
4T	ML12-P034-2-4T	ML12	> 12.63	-	ML12-JET-5/16	12.82
5T	ML12-P034-1-5T					

Accessoires  
Zubehöre  
Accessories

Tsugami P034

max + 17 outils  
+ 17 Werkzeuge  
+ 17 tools

ML12

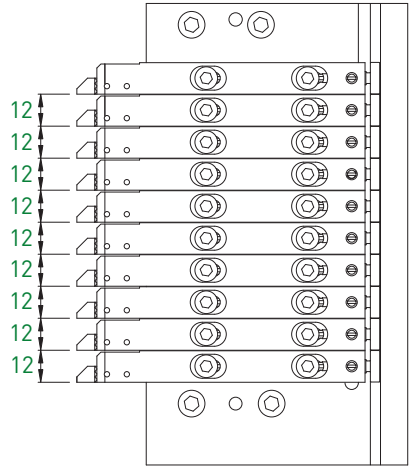
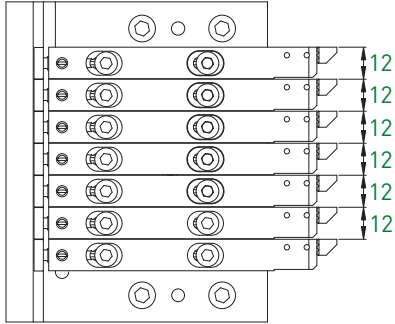

ML12-P034-1-7T

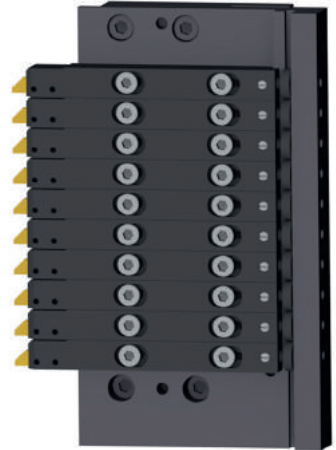

ML12-P034-2-10T





ML12-P034-1-7T



ML12-P034-2-10T

Type Typ Type	Art. N°	Porte-outils Halter Holders	Pages Seiten Pages	Accessoires Zubehöre Accessories		
				Module de serrage Spannelement Clamping unit	Module d'arrosage Kühlmitelzufuhrelement Coolant supply unit	Page Seite Page
7T	<b>ML12-P034-1-7T</b>	ML12	> 12.63	-	<b>ML12-JET-5/16</b>	12.82
10T	<b>ML12-P034-2-10T</b>					

Les différents types de porte-outils  
Die verschiedenen Haltertypen  
The various types of holders

Type Standard

ML12A-740



Type -D

ML12A-740-D



Type -JET-D

ML12A-740-JET-D

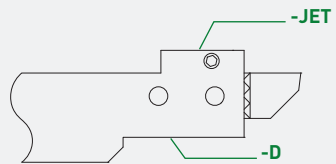
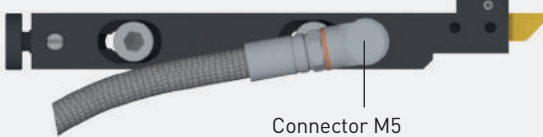

Type -JET

ML12A-740-JET

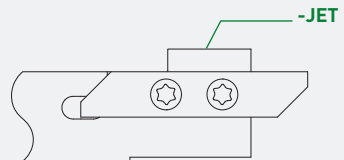
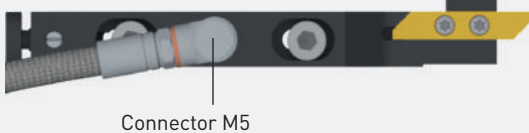

Informations techniques  
 Technische Informationen  
 Technical information

Porte-outils  
 Halter  
 Holders

Compatibilité  
 Kompatibilität  
 Compatibility

OK

NOT OK

-JET-D -D

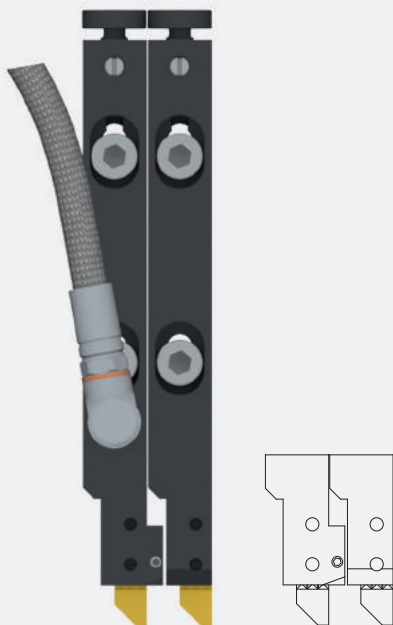

-JET-D -Standard

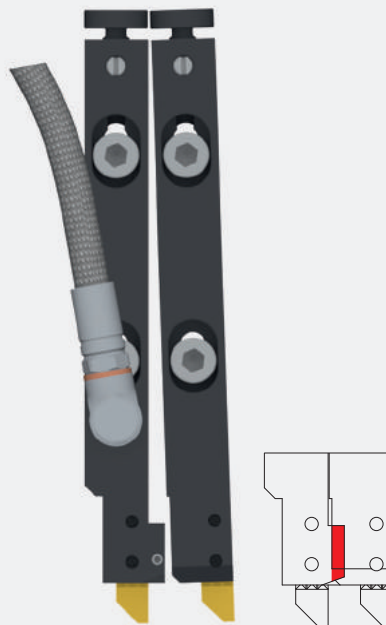

MIX

TYPE D

-Standard -JET-D -D



-JET-D -D -JET-D -D

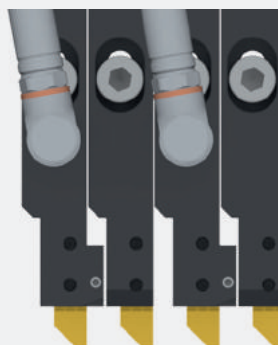

Exceptions  
 Ausnahmen  
 Exceptions

Exception ML12

Exception ML16

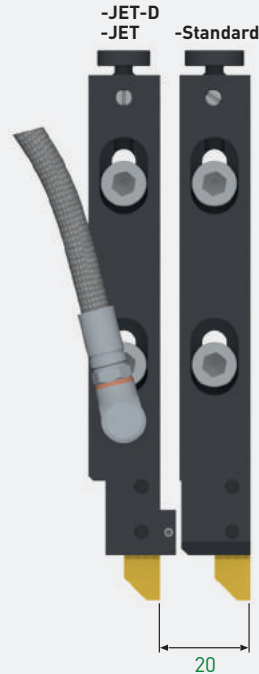
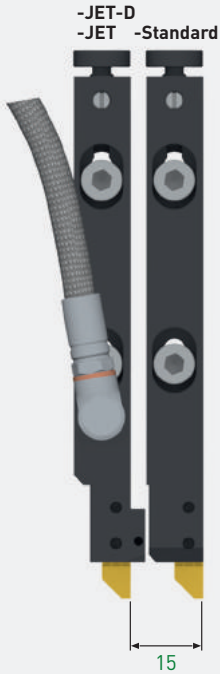

≥ 15 mm = Total compatibility

≥ 20 mm = Total compatibility

**Brochure JET-Line:**

Système de distribution du liquide de refroidissement pour haute pression

**JET-Line Broschüre:**

Kühlmittelverteilungssystem für hohen Druck

**JET-Line brochure:**

Coolant distribution system for high pressure

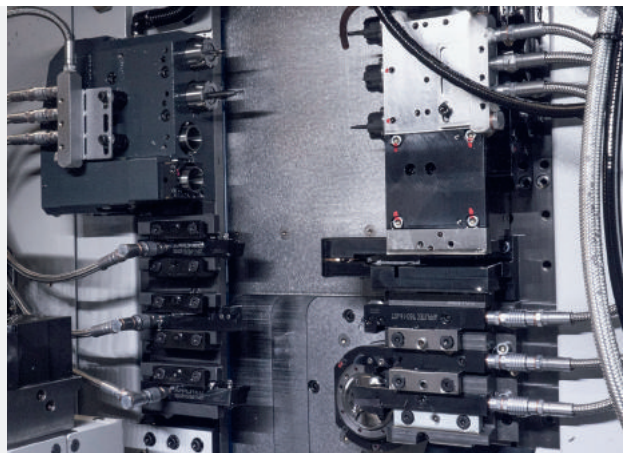

Porte-outils

Halter

Holders

ML12 / ML16

Système de fixation  
Befestigungssystem  
Clamping system

A = réglable  
einstellbar  
adjustable

F = longueur fixe  
fixlänge  
fixed length

ML12A

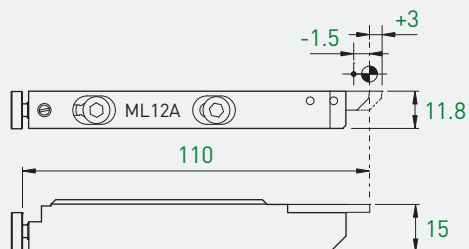

ML12F

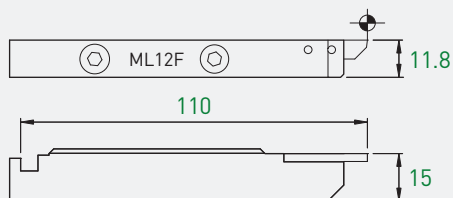

ML16A

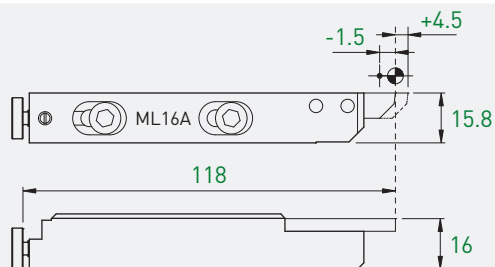

ML16F

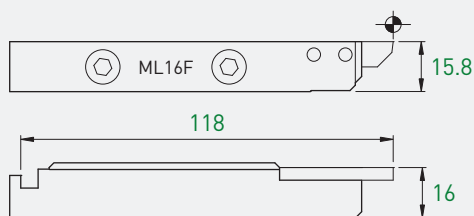

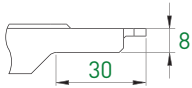

TOP-Line  
731-737

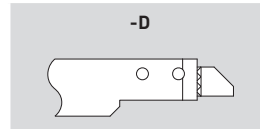

Art. N°	Art. N°	Art. N°
ML12	ML12	ML12
-	ML12A-730-C-D <b>new</b>	-

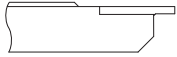

TOP-Line  
741-747

Standard	-D	-JET-D
ML12	ML12	ML12
ML12A-740	ML12A-740-D	ML12A-740-JET-D
ML12F-740	ML12F-740-D	-
ML16	ML16	ML16
ML16A-740	ML16A-740-D	ML16A-740-JET-D
ML16F-740	-	-

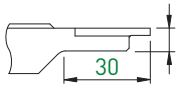

TOP-Line  
741-747

ML12	ML12	ML12
ML12A-740-C	ML12A-740-C-D	ML12A-740-C-JET-D
ML12F-740-C	ML12F-740-C-D	-

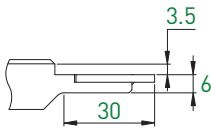

TOP-Line  
741

ML12	ML12	ML12
ML12A-740-C-R04	-	-
ML12A-740-C-SWISS-NANO	-	-

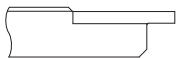

TOP-Line  
761-767

ML12	ML12	ML12
ML12A-760	ML12A-760-D	ML12A-760-JET-D
ML12F-760	ML12F-760-D	-
ML16	ML16	ML16
ML16A-760	ML16A-760-D	ML16A-760-JET-D
ML16F-760	-	-

Porte-plaquettes



WSP-Halter

Insert holders

TOP-Line

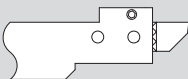

TOP-Line  
761-767

Standard	-D	-JET-D
		
Art. N°	Art. N°	Art. N°
ML16	ML16	ML16
ML16A-760-C	ML16A-760-C-D	-
ML16F-760-C	-	-

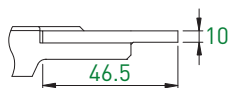

TOP-Line  
781

ML16	ML16	ML16
-	ML16A-780-C-D	-

Porte-plaquettes



WSP-Halter

Insert holders

TURN-Line

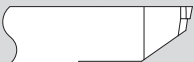

TURN-Line  
347-349

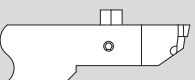
Standard	-D	-JET-D
		
Art. N°	Art. N°	Art. N°
ML12	ML12	ML12
ML12A-340	ML12A-340-D	ML12A-340-JET-D
ML12F-340	ML12F-340-D	-
ML16	ML16	ML16
ML16A-340	ML16A-340-D	ML16A-340-JET-D
ML16F-340	-	-

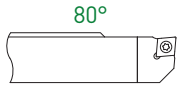

ISO-Line  
CC...-0602..

Standard	-D	-JET-D
Art. N°	Art. N°	Art. N°
<b>ML12</b>	<b>ML12</b>	<b>ML12</b>
ML12A-SCLCR06 ML12F-SCLCR06	ML12A-SCLCR06-D ML12F-SCLCR06-D	ML12A-SCLCR06-JET-D -
<b>ML16</b>	<b>ML16</b>	<b>ML16</b>
ML16A-SCLCR06 ML16F-SCLCR06	ML16A-SCLCR06-D ML16F-SCLCR06-D	ML16A-SCLCR06-JET-D -

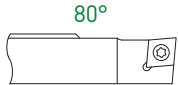

ISO-Line  
CC...-09T3..

<b>ML12</b>	<b>ML12</b>	<b>ML12</b>
ML12A-SCLCR09 ML12F-SCLCR09	ML12A-SCLCR09-D ML12F-SCLCR09-D	ML12A-SCLCR09-JET-D -
<b>ML16</b>	<b>ML16</b>	<b>ML16</b>
ML16A-SCLCR09 ML16F-SCLCR09	ML16A-SCLCR09-D ML16F-SCLCR09-D	ML16A-SCLCR09-JET-D -

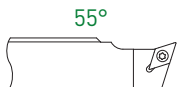

ISO-Line  
DC...-0702..

<b>ML16</b>	<b>ML16</b>	<b>ML16</b>
ML16A-SDHCR07	-	-

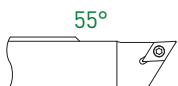

ISO-Line  
DC...-0702..

<b>ML12</b>	<b>ML12</b>	<b>ML12</b>
ML12A-SDJCR07 ML12F-SDJCR07	ML12A-SDJCR07-D ML12F-SDJCR07-D	ML12A-SDJCR07-JET-D -
<b>ML16</b>	<b>ML16</b>	<b>ML16</b>
ML16A-SDJCR07 ML16F-SDJCR07	ML16A-SDJCR07-D ML16F-SDJCR07-D	ML16A-SDJCR07-JET-D -



Porte-plaquettes

WSP-Halter

Insert holders

ISO-Line



ISO-Line  
DC...-11T3..

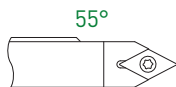

ISO-Line  
DC...-11T3..



ISO-Line  
VC...-1103..

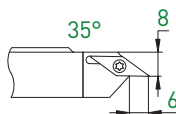

ISO-Line  
VC...-1103..

Standard	-D	-JET-D
Art. N°	Art. N°	Art. N°
ML12	ML12	ML12
ML12A-SDJCR11	ML12A-SDJCR11-D	ML12A-SDJCR11-JET-D
ML12F-SDJCR11	ML12F-SDJCR11-D	-
ML16	ML16	ML16
ML16A-SDJCR11	ML16A-SDJCR11-D	ML16A-SDJCR11-JET-D
ML16F-SDJCR11	ML16F-SDJCR11-D	-

ML12	ML12	ML12
ML12A-SDNCN11	ML12A-SDNCN11-D	-
ML12F-SDNCN11	ML12F-SDNCN11-D	-
ML16	ML16	ML16
ML16A-SDNCN11	ML16A-SDNCN11-D	-
ML16F-SDNCN11	ML16F-SDNCN11-D	-

ML12	ML12	ML12
ML12A-SVJCR11	ML12A-SVJCR11-D	ML12A-SVJCR11-JET-D
ML12F-SVJCR11	ML12F-SVJCR11-D	-
ML16	ML16	ML16
ML16A-SVJCR11	ML16A-SVJCR11-D	ML16A-SVJCR11-JET-D
ML16F-SVJCR11	ML16F-SVJCR11-D	-

ML12	ML12	ML12
ML12A-SV-CR11	ML12A-SV-CR11-D	-
ML16	ML16	ML16
ML16A-SV-CR11	ML16A-SV-CR11-D	-

# MODU-LINE

Porte-plaquettes  
WSP-Halter  
Insert holders

ISO-Line

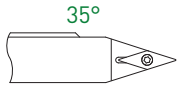

ISO-Line  
VC...-1103..

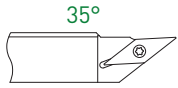

ISO-Line  
VC...-1303..

Standard	-D	-JET-D
Art. N°	Art. N°	Art. N°
<b>ML12</b>	<b>ML12</b>	<b>ML12</b>
<b>ML12A-SVVCN11</b>	<b>ML12A-SVVCN11-D</b>	<b>ML12A-SVVCN11-JET-D</b>
<b>ML12F-SVVCN11</b>	<b>ML12F-SVVCN11-D</b>	-
<b>ML16</b>	<b>ML16</b>	<b>ML16</b>
<b>ML16A-SVVCN11</b>	<b>ML16A-SVVCN11-D</b>	-
<b>ML16F-SVVCN11</b>	<b>ML16F-SVVCN11-D</b>	-
<b>ML12</b>	<b>ML12</b>	<b>ML12</b>
-	<b>ML12A-SVJCR13-D</b>	-
<b>ML16</b>	<b>ML16</b>	<b>ML16</b>
-	<b>ML16A-SVJCR13-D</b>	<b>ML16A-SVJCR13-JET-D</b>

Porte-plaquettes  
WSP-Halter  
Insert holders

EVOCUT-Line

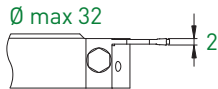

EVOCUT-Line  
ET20..

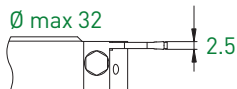

EVOCUT-Line  
ET25..

		-JET (-D)
Art. N°	Art. N°	Art. N°
<b>ML16</b>	<b>ML16</b>	<b>ML16</b>
-	-	<b>ML16A-ET20-JET32</b>
<b>ML16</b>	<b>ML16</b>	<b>ML16</b>
-	-	<b>ML16A-ET25-JET32</b>

Porte-plaquettes

WSP-Halter

Insert holders

EVOCUT-Line

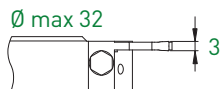

EVOCUT-Line  
ET30..

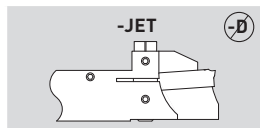

Art. N°	Art. N°	Art. N°
ML16	ML16	ML16
-	-	ML16A-ET30-JET32

Porte-plaquettes

WSP-Halter

Insert holders

CUT-Line



CUT-Line  
CUT16..

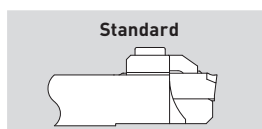

Art. N°	Art. N°	Art. N°
ML12	ML12	ML12
ML12A-CUT16	-	-
ML12F-CUT16	-	-
ML16	ML16	ML16
ML16A-CUT16	-	-
ML16F-CUT16	-	-



CUT-Line  
CUT22..

ML12	ML12	ML12
ML12A-CUT22	-	-
ML12F-CUT22	-	-
ML16	ML16	ML16
ML16A-CUT22	-	-
ML16F-CUT22	-	-

# MODU-LINE

Porte-plaquettes  
WSP-Halter  
Insert holders

PRO-Line

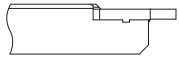

PRO-Line  
642-647

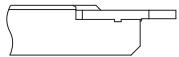

PRO-Line  
661

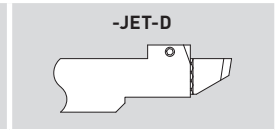
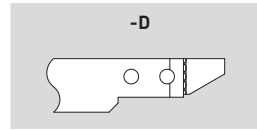

Art. N°	Art. N°	Art. N°
ML12	ML12	ML12
-	ML12A-640-D	ML12A-640-JET-D
ML16	ML16	ML16
-	ML16A-640-D	ML16A-640-JET-D

ML12	ML12	ML12
-	ML12A-660-D	ML12A-660-JET-D
ML16	ML16	ML16
-	ML16A-660-D	ML16A-660-JET-D

Porte-plaquettes  
WSP-Halter  
Insert holders

ECO-Line

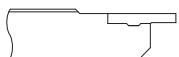

ECO-Line  
261-266

Standard	-D	-JET-D
Art. N°	Art. N°	Art. N°
ML12	ML12	ML12
ML12A-260	ML12A-260-D	ML12A-260-JET-D
ML12F-260	ML12F-260-D	-
ML16	ML16	ML16
ML16A-260	ML16A-260-D	ML16A-260-JET-D
ML16F-260	-	-

Porte-outils

Halter

Holders

IN-Line

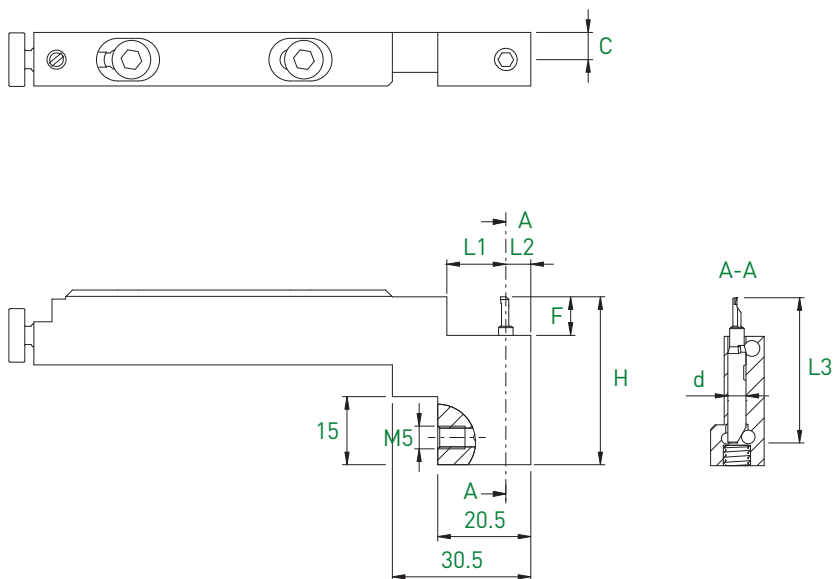

								ML12
d	Compatible bars	L3	F	H	C	L1	L2	Art. N°
4	BB4R... BF4R...	32	8.5	37	6	13	5.5	ML12A-BHK4N-32R-D
		37	13.5	42	6	13	5.5	ML12A-BHK4N-37R-D
		42	18.5	47	6	13	5.5	ML12A-BHK4N-42R-D

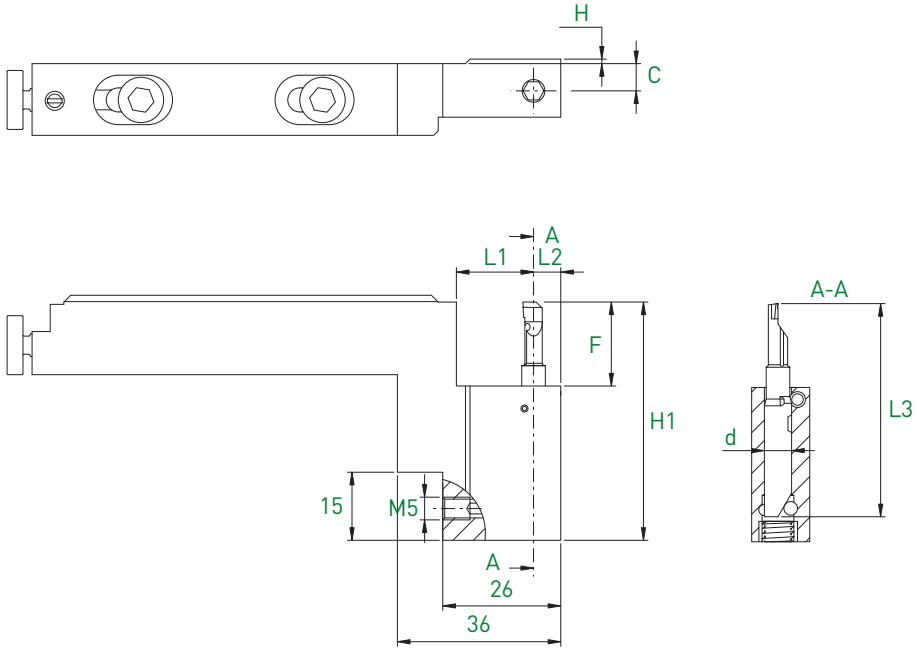

									ML16
d	Compatible bars	L3	F	H1	C	H	L1	L2	Art. N°
4	BB4R... BF4R...	32	8.5	37	6	-	17.5	5.5	ML16A-BHK4N-32R-D
		37	13.5	42	6	-	17.5	5.5	ML16A-BHK4N-37R-D
		42	18.5	47	6	-	17.5	5.5	ML16A-BHK4N-42R-D

									ML16
d	Compatible bars	L3	F	H1	C	H	L1	L2	Art. N°
6	BB4R... BF4R...	47	18.5	52.5	6	1	17	6	ML16A-BHK6N-47R-D
		57	28.5	62.5	6	1	17	6	ML16A-BHK6N-57R-D

Porte-outils

Halter

Holder

TOOLING-Line

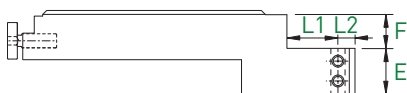
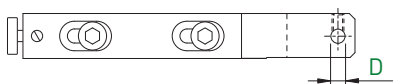

					ML12
F	D	E	L1	L2	Art. N°
8	3	12	13	6	ML12A-2440-8-3
8	4	12	13	6	ML12A-2440-8-4
8	5	12	13	6	ML12A-2440-8-5
12	6	12	13	6	ML12A-2440-12-6

					ML16
F	D	E	L1	L2	Art. N°
12	3	16	18	6	ML16A-2440-12-3
12	4	16	18	6	ML16A-2440-12-4
12	5	16	18	6	ML16A-2440-12-5
12	6	16	18	6	ML16A-2440-12-6
18	8	16	18	6	ML16A-2440-18-8

Porte-molettes

Rändelhalter

Knurl holders

TOOLING-Line

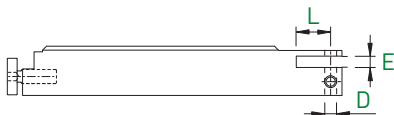
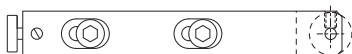

			ML12
E	D	L	Art. N°
4	4	8	ML12A-2402-44

			ML16
E	D	L	Art. N°
4	4	11	ML16A-2402-44

# MODU-LINE

Porte-plaquettes – Coupe déportée & contre-opération

WSP-Halter – Versetztes Schneiden & Gegenspindel

Insert holders – Cut off line & cut on subspindle

Coupe à droite déportée ou usinage  
à gauche sur contre-broche

Rechtsschneidend versetzt oder  
linksschneidend auf Gegenspindel

Right hand cut off line or left hand  
cut on subspindle

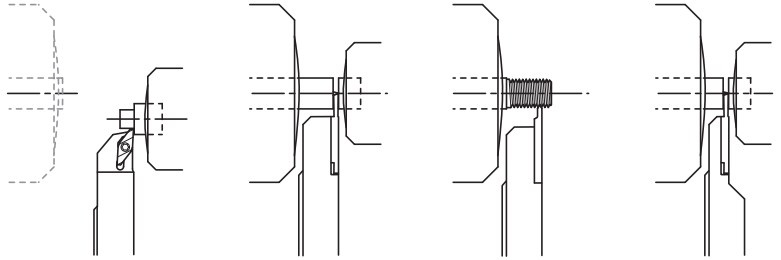

TURN-Line  
ISO-Line

TOP-Line  
EVOCUT-Line  
CUT-Line  
PRO-Line  
ECO-Line

TOP-Line  
EVOCUT-Line  
CUT-Line  
PRO-Line  
ECO-Line

TOP-Line  
PRO-Line  
ECO-Line

Porte-plaquettes – Coupe déportée & contre-opération



WSP-Halter – Versetztes Schneiden & Gegenspindel

Insert holders – Cut off line & cut on subspindle

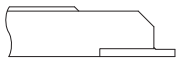
TOP-Line

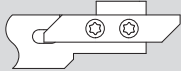

TOP-Line  
731-737

Standard	-D	-JET-D
		
Art. N°	Art. N°	Art. N°
ML12	ML12	ML12
ML12A-730-V	ML12A-730-V-D	ML12A-730-V-JET-D
ML16	ML16	ML16
ML16A-730-V	ML16A-730-V-D	ML16A-730-V-JET-D





Porte-plaquettes – Coupe déportée & contre-opération

WSP-Halter – Versetztes Schneiden & Gegenspindel

Insert holders – Cut off line & cut on subspindle

TOP-Line

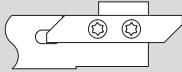
Standard	-D	-JET 
		
Art. N°	Art. N°	Art. N°
ML12	ML12	ML12
ML12A-730RC	-	ML12A-730RC-JET

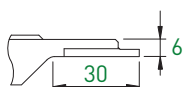

TOP-Line  
731R

ML16	ML16	ML16
ML16A-730RC	ML16A-730RC-D	ML16A-730RC-JET-D

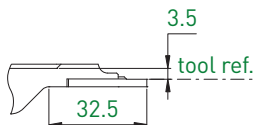

TOP-Line  
731R

ML12	ML12	ML12
ML12A-730RC-R04	-	-
ML12A-730RC-SWISS-NANO	-	-



TOP-Line  
751-757

ML12	ML12	ML12
ML12A-750-V	ML12A-750-V-D	ML12A-750-V-JET-D
ML16	ML16	ML16
ML16A-750-V	ML16A-750-V-D	ML16A-750-V-JET-D



TOP-Line  
751R

ML12	ML12	ML12 
ML12A-750RC	-	ML12A-750RC-JET
ML16	ML16	ML16
ML16A-750RC	ML16A-750RC-D	ML16A-750RC-JET-D



# MODU-LINE

Porte-plaquettes – Coupe déportée & contre-opération  
 WSP-Halter – Versetztes Schneiden & Gegenspindel  
 Insert holders – Cut off line & cut on subspindle

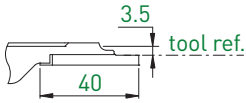
TOP-Line

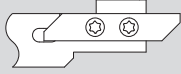

TOP-Line  
751R

Standard	-D	-JET-D
		
Art. N°	Art. N°	Art. N°
ML12	ML12	ML12
ML12A-750RC-R04	-	-
ML12A-750RC-SWISS-NANO	-	-

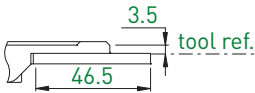

TOP-Line  
771R



ML12	ML12	ML12
ML12A-770RC-SWISS-NANO	-	-

Porte-plaquettes – Contre-opération  
 WSP-Halter – Gegenspindel  
 Insert holders – Cut on subspindle

TURN-Line



TURN-Line  
337-339

Standard	-D	-JET-D
		
Art. N°	Art. N°	Art. N°
ML12	ML12	ML12
ML12A-330-V	ML12A-330-V-D	ML12A-330-V-JET-D
ML16	ML16	ML16
ML16A-330-V	ML16A-330-V-D	ML16A-330-V-JET-D

Porte-plaquettes – Contre-opération

WSP-Halter – Gegenspindel

Insert holders – Cut on subspindle

ISO-Line

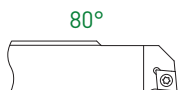

ISO-Line  
CC...0602..

Standard	-D	-JET-D
Art. N°	Art. N°	Art. N°
ML12	ML12	ML12
-	ML12A-SCLCL06-V-D	ML12A-SCLCL06-V-JET-D
ML16	ML16	ML16
-	ML16A-SCLCL06-V-D	ML16A-SCLCL06-V-JET-D

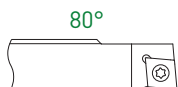

ISO-Line  
CC...9T3..

ML12	ML12	ML12
-	ML12A-SCLCL09-V-D	ML12A-SCLCL09-V-JET-D
ML16	ML16	ML16
-	ML16A-SCLCL09-V-D	ML16A-SCLCL09-V-JET-D

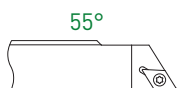

ISO-Line  
DC...0702..

ML12	ML12	ML12
-	ML12A-SDJCL07-V-D	ML12A-SDJCL07-V-JET-D
ML16	ML16	ML16
-	ML16A-SDJCL07-V-D	ML16A-SDJCL07-V-JET-D

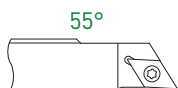

ISO-Line  
DC...11T3..

ML12	ML12	ML12
ML12A-SDJCL11-V	ML12A-SDJCL11-V-D	ML12A-SDJCL11-V-JET-D
ML16	ML16	ML16
ML16A-SDJCL11-V	ML16A-SDJCL11-V-D	ML16A-SDJCL11-V-JET-D

# MODU-LINE

Porte-plaquettes – Contre-opération

WSP-Halter – Gegenspindel

Insert holders – Cut on subspindle

ISO-Line

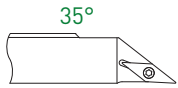

35°

ISO-Line  
VC...-1103..

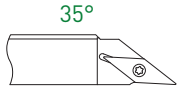

35°

ISO-Line  
VC...-1303..

Standard	-D	-JET-D
Art. N°	Art. N°	Art. N°
ML12	ML12	ML12
ML12A-SVJCL11-V	ML12A-SVJCL11-V-D	ML12A-SVJCL11-V-JET-D
ML16	ML16	ML16
ML16A-SVJCL11-V	ML16A-SVJCL11-V-D	ML16A-SVJCL11-V-JET-D

ML12	ML12	ML12
-	ML12A-SVJCL13-V-D	-
ML16	ML16	ML16
-	ML16A-SVJCL13-V-D	ML16A-SVJCL13-V-JET-D

Porte-plaquettes – Coupe déportée

WSP-Halter – Versetztes Schneiden

Insert holders – Cut off line

EVO CUT-Line

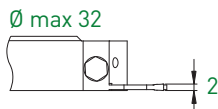

Ø max 32

EVO CUT-Line  
ET20

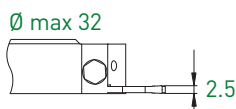

Ø max 32

EVO CUT-Line  
ET25

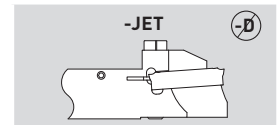

Art. N°	Art. N°	Art. N°
ML16	ML16	ML16
-	-	ML16A-ET20-V-JET32

ML16	ML16	ML16
-	-	ML16A-ET25-V-JET32

Porte-plaquettes – Coupe déportée

WSP-Halter – Versetztes Schneiden

Insert holders – Cut off line

EVOCUT-Line

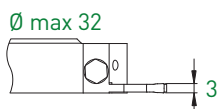

EVOCUT-Line  
ET30

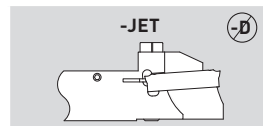

ML16	ML16	ML16
-	-	ML16A-ET30-V-JET32

Porte-plaquettes – Coupe déportée

WSP-Halter – Versetztes Schneiden

Insert holders – Cut off line

CUT-Line

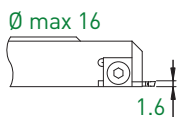

CUT-Line  
CUT16

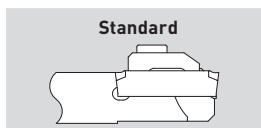

Art. N°	Art. N°	Art. N°
ML12	ML12	ML12
ML12A-CUT16-V	-	-
ML12F-CUT16-V	-	-
ML16	ML16	ML16
ML16A-CUT16-V	-	-
ML16F-CUT16-V	-	-

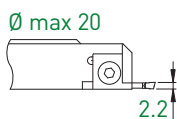

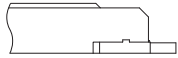

CUT-Line  
CUT22

ML12	ML12	ML12
ML12A-CUT22-V	-	-
ML12F-CUT22-V	-	-
ML16	ML16	ML16
ML16A-CUT22-V	-	-
ML16F-CUT22-V	-	-



PRO-Line  
632-636

Standard	-D	-JET-D
		
Art. N°	Art. N°	Art. N°
ML12	ML12	ML12
-	ML12A-630-V-D	ML12A-630-V-JET-D
ML16	ML16	ML16
-	ML16A-630-V-D	ML16A-630-V-JET-D

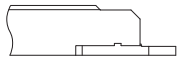

PRO-Line  
651R

ML12	ML12	ML12
-	ML12A-650-V-D	ML12A-650-V-JET-D
ML16	ML16	ML16
-	ML16A-650-V-D	ML16A-650-V-JET-D

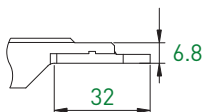

PRO-Line  
651R

ML12	ML12	ML12
ML12A-650RC	ML12A-650RC-D	-
ML16	ML16	ML16
-	ML16A-650RC-D	ML16A-650RC-JET-D

Porte-plaquettes – Coupe déportée & contre-opération



WSP-Halter – Versetztes Schneiden & Gegenspindel

Insert holders – Cut off line & cut on subspindle

ECO-Line

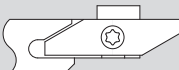

ECO-Line  
251-261

Standard	-D	-JET-D
		
Art. N°	Art. N°	Art. N°
ML12	ML12	ML12
ML12A-250-V	ML12A-250-V-D	ML12A-250-V-JET-D
ML16	ML16	ML16
ML16A-250-V	ML16A-250-V-D	ML16A-250-V-JET-D

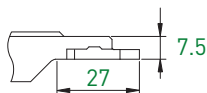

ECO-Line  
251R

ML12	ML12	ML12
-	ML12A-250RC-D	-
ML16	ML16	ML16
-	ML16A-250RC-D	-

# MODU-LINE

Modules d'arrosage  
Kühlmittelzufuhrelemente  
Coolant supply units

## ML12 / ML16

ML12

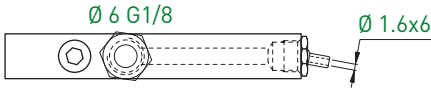

Raccord Anschluss Connection	Buses d'arrosage Kühlmitteldüse Coolant nozzles	ML12 Art. N°
Ø 6 G 1/8	5/16"	ML12-JET-5/16

ML16

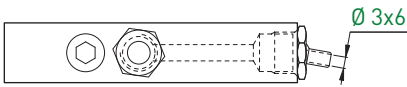

Raccord Anschluss Connection	Buses d'arrosage Kühlmitteldüse Coolant nozzles	ML16 Art. N°
Ø 6 G 1/8	7/16"	ML16-JET-7/16

buses optionnelles voir page 12.81  
zusätzliche Düsen siehe Seite 12.81  
optional nozzles see page 12.81

Modules de serrage  
Spannelemente  
Clamping units

## ML12 / ML16

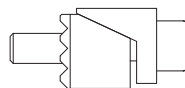
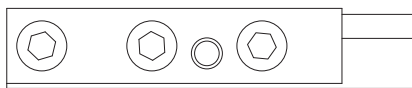

ML12 Art. N°	ML16 Art. N°
ML12-FIX-12/14	ML16-FIX-16/16
-	ML16-FIX-16/16.5
-	ML16-FIX-16/17
-	ML16-FIX-16/20
-	ML16-FIX-16/22
-	ML16-FIX-16/24

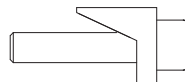
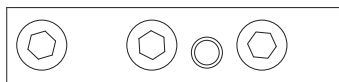

ML12 Art. N°	ML16 Art. N°
ML12-FIX-12	ML16-FIX-16



Buses d'arrosage

Kühlmitteldüsen

Coolant nozzles

5/16" / 7/16"

JET

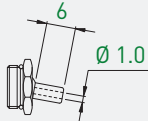
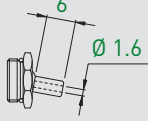
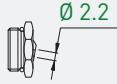
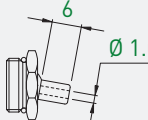
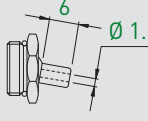
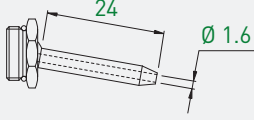
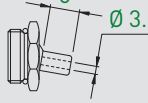
5/16"	Art. N°	Références compatibles Kompatible Artikeln Compatible items
	ML-JET 5/16-1.0X6	ML12-JET-5/1.6
	ML-JET 5/16-1.6X6	<p>une buse <b>ML-JET-5/16-1.6x6</b> est comprise</p> <p>eine Düse <b>ML-JET-5/16-1.6x6</b> ist inbegriffen</p> <p>a nozzle <b>ML-JET-5/16-1.6x6</b> is included</p>
	ML-JET 5/16-2.2X0	
7/16"	Art. N°	Références compatibles Kompatible Artikeln Compatible items
	ML-JET 7/16-1.0X6	
	ML-JET 7/16-1.6X6	<p>ML16-KMX26-JET ML16-JET-7/16 ML12-DEC010-JET ML16-DEC013-JET ML16-DEC020-JET ML16-S20-JET ML16-SWISS-ST26-JET</p>
	ML-JET-7/16-1.6X24	<p>une buse <b>ML-JET-7/16-3.0x6</b> est comprise avec chaque article ci-dessus</p> <p>eine Düse <b>ML-JET 7/16-3.0x6</b> ist mit jedem vorstehenden Artikel inbegriffen</p>
	ML-JET-7/16-3.0X6	<p>a nozzle <b>ML-JET 7/16-3.0x6</b> is included with each above item</p>

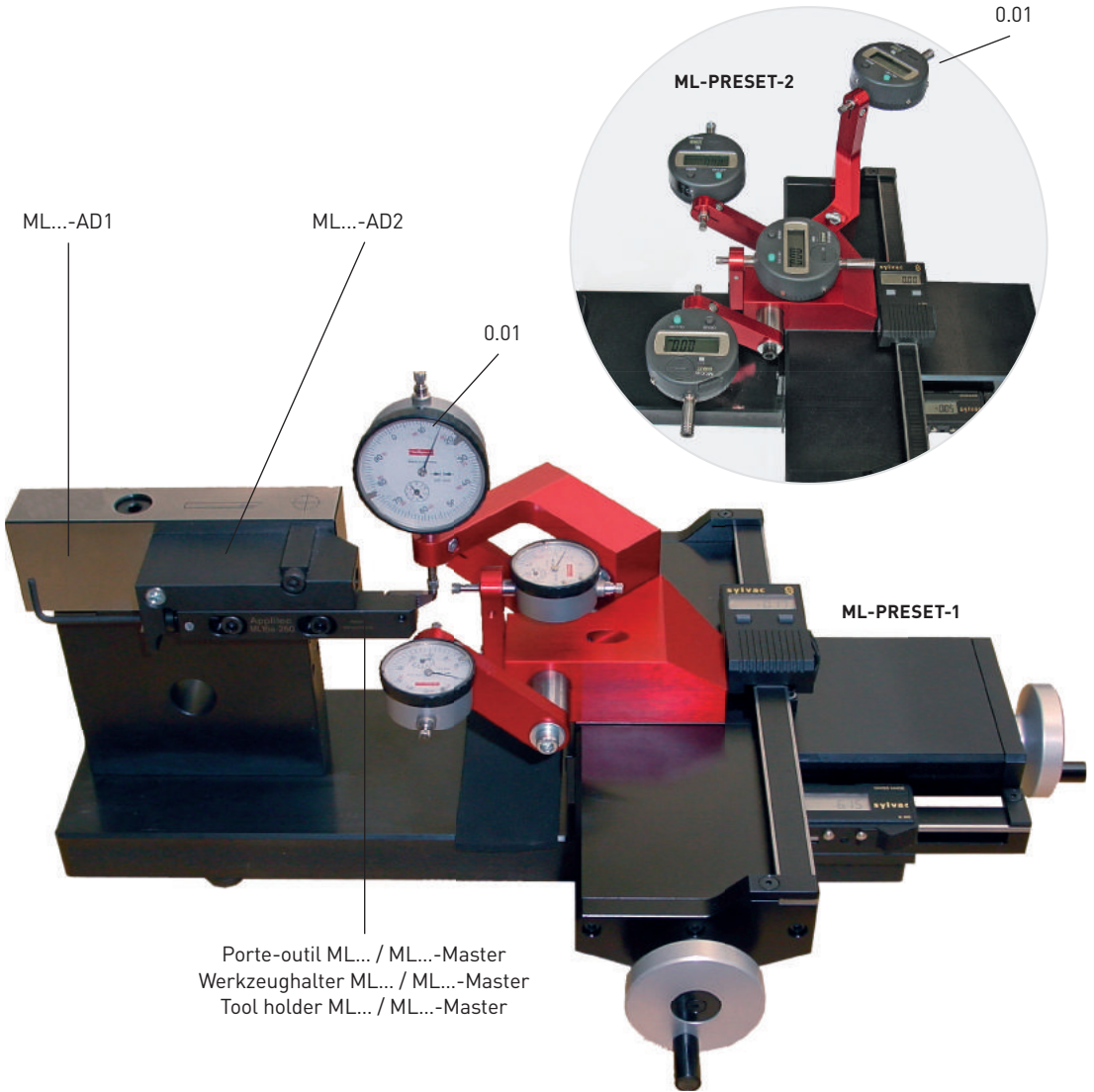

Art. N°

ML-PRESET-1

ML-PRESET-2

**Banc de pré réglage**

**Voreinstellgerät**

**Presetting device**

**ML12 / ML16**

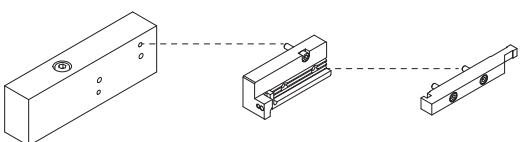
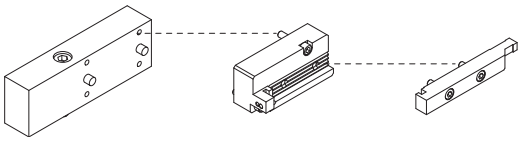
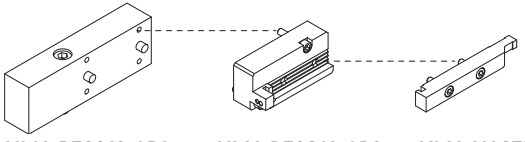
Type Typ Type	Fabricant Hersteller Manufacturer	Machines Maschinen Machines	Adaptateurs et jauges d'étalonnage Adapter und Einstellehre Adaptators and master gauges	
ML12	CITIZEN	C12/C16	 <p><b>ML12-AD1</b>      <b>ML12-AD2</b>      <b>ML12-MASTER</b></p>	
		L12-1M7		
		L12-2M10		
		M16 V/VIII		
		R04		
		R07		
	HANWHA	XD20M		
	METAFIL	D3/D10/D13		
		SB-12RG		
	STAR	SR10-J		
		SW-12RII		
	TORNOS	DECO7/10 - EvoDECO 10		
		SwissNano/SwissNano 7		
		DT13		
		CT20		
		GT13		
TSUGAMI	B074			
	B075			
	P034			
ML16	CITIZEN	K12/K16/K12E/K16E	 <p><b>ML16/20-AD1</b>      <b>ML16-AD2</b>      <b>ML16-MASTER</b></p>	
		L16/L20		
		L20E		
	HANWHA	SL12/16		
	MANUHRIN	KMX 426/526/626/Swing 20-26 MM		
		SA-12/SA-16/SA-16R		
		SB-16		
		SB-16/20RG		
		SB-20C/E		
		SR-20J/SR-20RIII		
		SR-20JII-A/B		
		SR-16R/SR-20R/SR-20RII		
		SR-20RIII/SR-20J		
		SR-20RIV		
		SR-32J		
		SV-12/20/ SV-20R		
		SW-20R		
		TORNOS		DECO20/26 - EvoDECO20/32
				SIGMA20/32
				DT26
GT26				
GT32				
ML16	TORNOS	DECO13-EvoDECO16	 <p><b>ML16-DECO13-AD1</b>      <b>ML16-DECO13-AD2</b>      <b>ML16-MASTER</b></p>	
		ST26		

### ML12

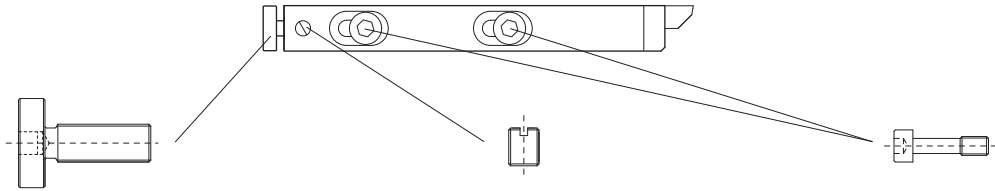

Vis de réglage  
Einstellungsschraube  
Setting screw

Art. N°

ML12A-M5X0.5

Vis de blocage  
Blockierschraube  
Locking screw

Art. N°

ML-M4X4-T

Vis de fixation  
Befestigungsschraube  
Fixing screw

Art. N°

ML12-M5XL20

### ML16

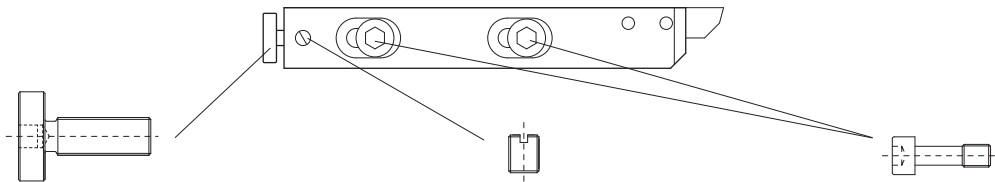

Vis de réglage  
Einstellungsschraube  
Setting screw

Art. N°

ML16A-M5X0.5

Vis de blocage  
Blockierschraube  
Locking screw

Art. N°

ML-M4X4-T

Vis de fixation  
Befestigungsschraube  
Fixing screw

Art. N°

ML16/20-M6XL20

Art. N°

ML-205004

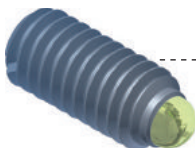

Butée à ressort  
Federnde Schraube  
Spring bumper

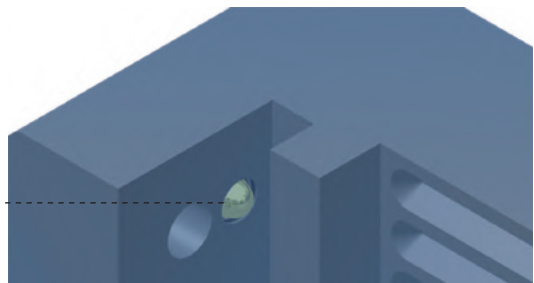





Pièces de rechange

Ersatzteile

Spare parts

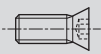
ML12 / ML16

Vis et clés pour le serrage des plaquettes  
Schrauben und Schlüssel für WSP-Befestigung  
Screws and keys for insert clamping

Porte-outils Halter Holders					
ML...250	<b>V-M4X9-T15</b>	<b>C-T15</b>	-	-	-
ML...260			-	-	-
ML...330	<b>V-M2.5X7.8-T8</b>	<b>C-T8</b>	-	-	-
ML...340			-	-	-
ML...630	<b>V-M4X9-T15</b>	<b>C-T15</b>	-	-	-
ML...640			-	-	-
ML...650	<b>V-M4X6.5-T15</b>	<b>V-M4X9-T15</b>	-	-	-
ML...650RC			-	-	-
ML...660	<b>V-M3X7-T8</b>	<b>V-M3X5.5-T8</b>	-	-	-
ML...730			-	-	-
ML...730RC	<b>V-M3X4.5-T8</b>	<b>V-M3X7-T8</b>	-	-	-
ML...730RC-R04			-	-	-
ML...730RC-SWISS-NANO	<b>V-M3X4.5-T8</b>	<b>C-T8</b>	-	-	-
	<b>V-M3X7-T8</b>		-	-	-
ML...740	<b>V-M3X7-T8</b>	<b>V-M4X9-T15</b>	-	-	-
ML...750			-	-	-
ML...750RC	<b>V-M4X7.3-T15</b>	<b>V-M4X5.6-T15</b>	-	-	-
ML...750RC-R04			-	-	-
ML...750RC-SWISS-NANO	<b>V-M4X5.6-T15</b>	<b>C-T15</b>	-	-	-
	<b>V-M4X7.3-T15</b>		-	-	-
ML...760	<b>V-M4X9-T15</b>	<b>V-M4X7.3-T15</b>	-	-	-
ML...770RC-SWISS-NANO			-	-	-
ML...780	<b>V-M4X9-T15</b>	<b>V-M2.5X5.8-T8</b>	-	-	-
ML...SC...06			-	-	-
ML...SC...09	<b>V-M4X7-T15-ISO</b>	<b>C-T15</b>	-	-	-
ML...-SD...07			-	-	-
ML...-SD...07-D	<b>V-M2.5X5.8-T8</b>	<b>C-T8</b>	-	-	-
ML12...-SDJ...11			-	-	-
ML12...-SDN...11	<b>V-M4X7-T15-ISO</b>	<b>C-T15</b>	-	-	-
ML16...-SD...11			-	-	-
ML...-SV...11	<b>V-M4X9-T15-ISO</b>	<b>C-T15</b>	-	-	-
ML...-SV...13			-	-	-
ML...-CUT16	-	-	<b>CUT16RS-SET</b>	-	-
ML...-CUT16-V	-	-	<b>CUT16LS-SET</b>	-	-
ML...-CUT22	-	-	<b>CUT22RS-SET</b>	-	-
ML...-CUT16-V	-	-	<b>CUT22LS-SET</b>	-	-
ML16...-ET...JET32	-	-	-	-	-
ML16...-ET... V-JET32	-	-	-	<b>V-M5X21-6P7-J</b>	<b>C-6PEX-7.0</b>
ML...-BHK	<b>V-BHK-M4X0.5-T8</b>	-	-	-	-