



zeus knurling technology

Knurling wheels | Knurling tools

Special tools | Burnishing rolls



No compromises!

Knurling process	4
Tool characteristics	5
Tool selection	6
zeus form knurling tools	8
zeus form knurling tools RD1	9
zeus form knurling tools RD2	12
zeus form knurling tools RD3	16
zeus form knurling tool sets	18
zeus cut knurling tools	20
zeus cut knurling tools RF1	21
zeus cut knurling tools RF2	22
zeus cut knurling tools RF3	23
zeus cut knurling tool sets	24
zeus special tools and interfaces	26
zeus knurling wheels	34
Profiles and knurling pitches	35
Form knurling – non-cutting process	36
Cut knurling – cutting process	38
Special knurling wheels	39
Brunishing rolls	40
Features	41
Technology	42
Process characteristics	43
Wheel geometries	44
Conversion to inches	45
Material displacement – non-cutting forming	46
Reference values for cutting speed and feed rate	47
Optimization of knurling	48
Influencing factors	50

Our product range

offers tool solutions for the diverse applications of knurling technology. In addition to standard profiles, zeus knurling tools can also be used to manufacture conical, convex, concave and special profiles (e.g. bead knurling).

The example below shows the most important manufacturing applications.



Application	Profile (DIN 82) Marking	Tool Examples	Knurling wheels/ marking rolls
Cut knurling, axial	RGE30°	291	3 x AA
Cut knurling, axial	RGE45°	241	1 x BL15° 1 x BR15°
Cut knurling, axial	RAA	231	1 x BR30°
Form knurling, radial	RKV	132	1 x KE
Form knurling, radial	RKE	131	1 x KV
Form knurling, radial	RGE45°	141	1 x BL45° 1 x BR45°
Form knurling, radial + axial up to a shoulder	RAA	162	2 x AA
Form knurling, radial	RHE	131	1 x HV
Form knurling, radial	RE	131	1 x C
Form knurling, radial	RC	131	1 x E
Form knurling radial + axial	RKAA	311	1 x KAA
Form knurling, axial	RAA-face	311	1 x AA
Form knurling	RKGV	311	1 x KGE
Continuous roll marking	zeus	130	40 W
Spring return marking	hommel+keller.de	431	41 W

Knurling process

Knurling technology is divided into two processes: form knurling and cut knurling. Both processes have their special applications and areas of utilisation.

A basic difference in the two marking technologies is the possible direction of machining and the capability of manufacturing knurling profiles on the workpiece.

For more details on manufacturing the individual profiles see the tool view.

Possible knurling profiles on the workpiece

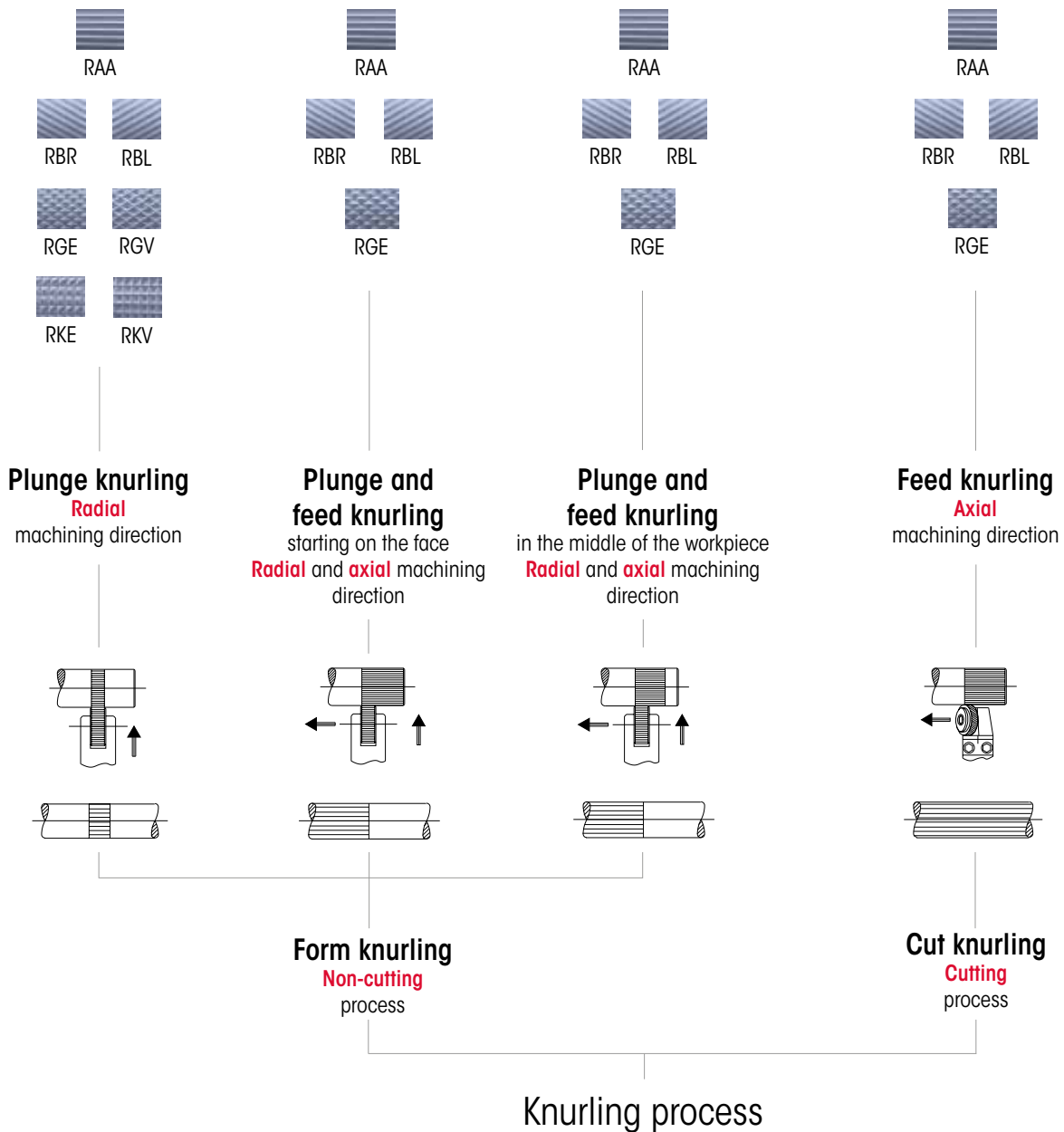

Different characteristics based on machine types and machine properties

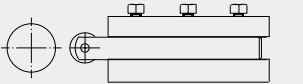
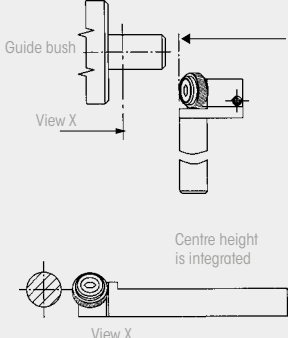
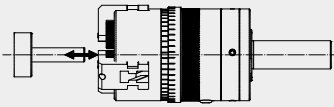
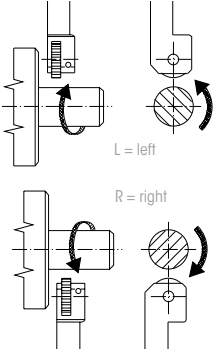
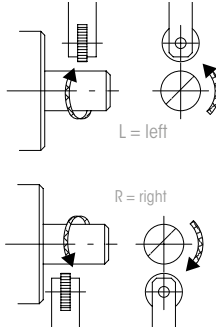
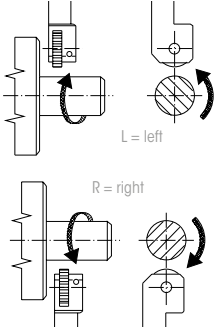
Knurling tools for CNC lathes/ automatic lathes	Knurling tools for conventional lathes/ automatic lathes	Knurling tools for Swiss-type lathes/ automatic lathes	Knurling tools for axial machining
<p>The knurling tools for CNC lathes/automatic lathes features an integrated centre height (centre height = top edge of shank). This makes it possible to use them in CNC lathes/automatic lathes without the capability of adjustment (fixed tool holder) of the centre height. In general, these knurling tool series are also suitable for conventional lathes/automatic lathes as long as the centre height can be adjusted on the machine.</p>	<p>Knurling tools from zeus for conventional machine types are designed so that the centre height must be adjusted by the tool holder in the machine. This results in a simplified design of these knurling tools.</p>	<p>In the case of knurling tools that are suitable for Swiss-type lathes/automatic lathes, the knurling wheel must not protrude beyond the front edge of the shank, in order to prevent collision with the guide bush. Most knurling tools with a shank height of 10–16 mm are suitable for Swiss-type lathes/automatic lathes. In general, they can also be used in CNC lathes and conventional lathes/automatic lathes.</p>	<p>Knurling tools for axial machining of the workpiece can be clamped axially to the workpiece on all conventional and CNC lathes/automatic lathes with a tailstock. Machining takes place by means of a rotating workpiece in a stationary tool that is mounted in the tailpiece.</p> <p>On rotary indexing machines, indexing tables and automatic transfer machines, a stationary workpiece is machined by means of an axially rotating tool.</p>
<p>The tool holder is not height adjustable. The centre height is integrated in the tool.</p> 	<p>The tool holder is adjustable. The centre height of the tool must be adjusted.</p> 		
<p>The zeus product range includes special versions for (R) right- and (L) left-oriented lathes/automatic lathes. If the construction allows, zeus knurling tools are available in a modular (M) or universal (U) design. The (M) versions can be converted from counterclockwise to clockwise rotation by simply turning the knurling head. The (U) versions can be used for both clockwise and counterclockwise rotation without conversion.</p> 	<p>Knurling tools from zeus for conventional machine types are designed for universal use and can therefore be used with both clockwise and counterclockwise rotation.</p> 	<p>In the case of Swiss-type lathes/automatic lathes the knurling wheel should be positioned as close to the workpiece clamping as possible to allow machining of workpieces with small diameters. The knurling wheels of the zeus RD1 and RD2 series with shank dimensions of 10 x 10 to 16 x 16 are therefore offset instead of centred.</p> 	<p>Machining possibilities:</p> <ul style="list-style-type: none"> • Tool is stationary • Workpiece rotates • Direction of rotation is universal <ul style="list-style-type: none"> • Tool rotates • Workpiece is stationary • Direction of rotation is universal

Tool selection

Symbols:

- LD** = Swiss-type lathes (CNC/conventional)
- KD** = Automatic-short-turning lathes/universal lathes/ turning/ milling centres (CNC/conventional)
- MS** = Multi-spindle lathes (CNC/conventional)
- RT** = Rotary indexing machines/indexing tables/ automatic transfer machines
- x** = Process is not possible with this application
- ▲** = Length of knurling is limited
- *** = For cut knurling RBR/RBL possible only to a limited extent

Explanation of arrows:

- Knurl can be manufactured in radial direction (plunge knurling)
- Knurl can be manufactured only in axial direction (feed knurling)
- Knurl can be manufactured in both axial and radial direction



Knurling profile (DIN 82)	Manufacturing process		Machine type	Knurling on workpiece centre/ without plunge cut	Knurling starting at workpiece beginning
	Form knurling	Cut knurling			
RAA knurl			LD	130 / 131 / 141 / 161	130 / 131 / 141 / 161 / 162▲ / 192▲ / 391
			KD	130 / 131 / 141 / 161	130 / 131 / 141 / 161 / 162▲ / 192▲ / 391
			MS	130 / 131 / 141 / 161	130 / 131 / 141 / 161 / 162▲ / 192▲ / 391
			RT	x	192▲ / 391
			LD	x	231
			KD	x	231
			MS	x	231
			RT	x	x
RBL left-hand knurl			LD	130 / 131 / 141 / 161	130 / 131
			KD	130 / 131 / 141 / 161	130 / 131
			MS	130 / 131 / 141 / 161	130 / 131
			RT	x	130 / 131
			LD	x	231*
			KD	x	231*
			MS	x	231*
			RT	x	x
RBR right-hand knurl			LD	130 / 131 / 141 / 161	130 / 131
			KD	130 / 131 / 141 / 161	130 / 131
			MS	130 / 131 / 141 / 161	130 / 131
			RT	x	130 / 131
			LD	x	231*
			KD	x	231*
			MS	x	231*
			RT	x	x
RGE left/right-hand knurl/ raised points/30°			LD	130 / 131 / 132 / 161	x
			KD	130 / 131 / 132 / 161	
			MS	130 / 131 / 132 / 161	
			RT		
			LD	141 / 161	141 / 161 / 162 / 192▲
			KD	141 / 161	141 / 161 / 162 / 192▲
			MS	141 / 161	141 / 161 / 162 / 192▲
			RT		161 / 162 / 192▲
		LD	x	241 / 291▲	
		KD	x	241 / 291▲	
		MS	x	241 / 291▲	
		RT		291▲	
RGV left/right-hand knurl/ lowered points/30°			LD	130 / 131	RGV: only plunge knurling possible
			KD	130 / 131	
			MS	130 / 131	
			RT		
RKE cross knurl/ raised points/90°			LD	130 / 131	RKE: only plunge knurling possible
			KD	130 / 131	
			MS	130 / 131	
			RT		
RKV cross knurl/ lowered points/90°			LD	130 / 131	RKV: only plunge knurling possible
			KD	130 / 131	
			MS	130 / 131	
			RT		

This matrix provides you with a selection of tool series that can be used for your application. You can use the table to define the profile, process and machine type.

Then you can choose the application based on the pictograms. Starting on page 9 you will find details of the products and tool features.

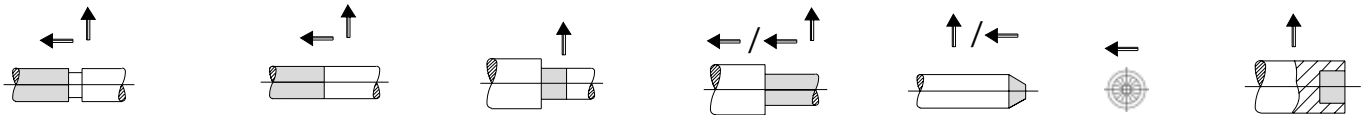

Knurling starting in centre of workpiece/ after plunge cut	Knurling starting in centre of workpiece/ without plunge cut	Knurling up to a shoulder	Knurling starting at workpiece beginning up to a shoulder	Conical knurling	Knurling on the front face	Knurling in a bore
130 / 131 / 141 / 161	130 / 131 / 141 / 161	132 / 142	132 / 142 / 162 ▲ / 192 ▲	311 / 312	311 / 312	330 / 332
130 / 131 / 141 / 161	130 / 131 / 141 / 161	132 / 142	132 / 142 / 162 ▲ / 192 ▲	311 / 312	311 / 312	330 / 332
130 / 131 / 141 / 161	130 / 131 / 141 / 161	132 / 142	132 / 142 / 162 ▲ / 192 ▲	311 / 312	311 / 312	330 / 332
X	X	X	162 ▲ / 192 ▲	X	X	330 / 332
231						
231						
231	X	X	X	X	X	X
X						
130 / 131 / 141 / 161	130 / 131 / 141 / 161	132 / 142	132 / 142 / 162 ▲ / 192 ▲	311 / 312	311 / 312	330 / 332
130 / 131 / 141 / 161	130 / 131 / 141 / 161	132 / 142	132 / 142 / 162 ▲ / 192 ▲	311 / 312	311 / 312	330 / 332
130 / 131 / 141 / 161	130 / 131 / 141 / 161	132 / 142	132 / 142 / 162 ▲ / 192 ▲	311 / 312	311 / 312	330 / 332
X	X	X	162 ▲ / 192 ▲	X	X	X
231*						
231*	X	X	X	X	X	X
231*						
X						
130 / 131 / 141 / 161	130 / 131 / 141 / 161	132 / 142	132 / 142 / 162 ▲ / 192 ▲	311 / 312	311 / 312	330 / 332
130 / 131 / 141 / 161	130 / 131 / 141 / 161	132 / 142	132 / 142 / 162 ▲ / 192 ▲	311 / 312	311 / 312	330 / 332
130 / 131 / 141 / 161	130 / 131 / 141 / 161	132 / 142	132 / 142 / 162 ▲ / 192 ▲	311 / 312	311 / 312	330 / 332
			162 ▲ / 192 ▲			
231*						
231*						
231*	X	X	X	X	X	X
X						
X	only plunge knurling possible	132	132	X	X	X
		132	132			
		132	132			
		X	162 ▲			
141 / 161	141 / 161	142	141 / 162 ▲ / 192 ▲	161 / 162	X	340 / 342
141 / 161	141 / 161	142	141 / 162 ▲ / 192 ▲	161 / 162		340 / 342
141 / 161	141 / 161	142	141 / 162 ▲ / 192 ▲	161 / 162		340 / 342
X	X	X	162 ▲ / 192 ▲	161 / 162		X
241						
241						
241	X	X	X	X	X	X
X						
RGV: only plunge knurling possible	RGV: only plunge knurling possible	132	RGV: only plunge knurling possible	311 / 312	311 / 312	330 / 332
		132		311 / 312	311 / 312	330 / 332
		132		311 / 312	311 / 312	330 / 332
		X		311 / 312	X	330 / 332
RKE: only plunge knurling possible	RKE: only plunge knurling possible	132	RKE: only plunge knurling possible	X	X	330 / 332
		132				330 / 332
		132				330 / 332
		X				330 / 332
RKV: only plunge knurling possible	RKV: only plunge knurling possible	132	RKV: only plunge knurling possible	X	X	330 / 332
		132				330 / 332
		132				330 / 332
		X				330 / 332



zeus
Form knurling
tools



Series 130



Tool holder Designation

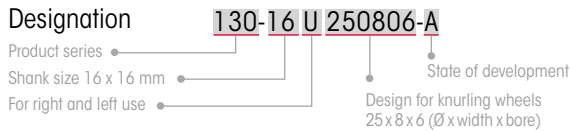

Knurling profiles on DIN 82 workpiece:

Plunge knurling

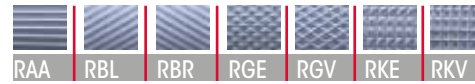

Selection of knurling wheels:



Feed knurling



Selection of knurling wheels:



Product features:

- Centre height must be adjusted
- Set screws in shank for clearance angle correction
- Carbide pins

TOOL VERSIONS:

Order no.	Tool holder Designation	Working area Ø [mm]	Dimension [mm]							Knurling wheels (Ø x b x b) [mm]
			a	b	c	d	e	f	x	
31000759	130-10U150404-A	3-50	10	10	99	-	-	-	1.5/4	10/15 x 4 x 4
31000760	130-10U150604-A	3-50	10	10	99	14	19	-	1.5/4	10/15 x 6 x 4
31000762	130-12U150404-A	3-50	12	12	99	-	-	-	1.5/4	10/15 x 4 x 4
31000763	130-12U250606-A	8-200	12	12	110.5	16	30.5	16	3/5.5	20/25 x 6 x 6
31000764	130-12U250806-A	8-200	12	12	110.5	16	30.5	16	3/5.5	20/25 x 8 x 6
31000765	130-14U150604-A	3-50	14	14	99	-	-	-	1.5/4	10/15 x 6 x 4
31000766	130-14U250606-A	8-200	14	14	110.5	-	-	-	3/5.5	20/25 x 6 x 6
31000767	130-16U250806-A	8-200	16	16	110.5	-	-	-	3/5.5	20/25 x 8 x 6
31000768	130-20U251006-A	8-200	20	20	110.5	-	-	-	3/5.5	20/25 x 10 x 6

Other variants available on request

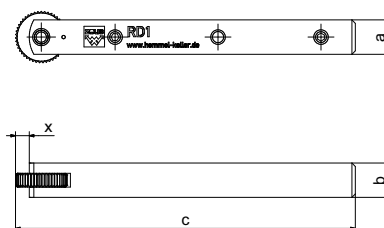
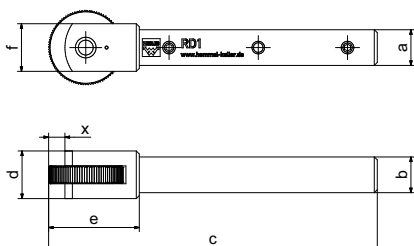

Series 131



Tool holder
Designation

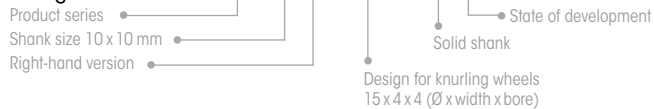

Knurling profiles on DIN 82 workpiece:

Plunge knurling



Selection of knurling wheels:



Feed knurling



Selection of knurling wheels:



Product features:

- All holders equipped with Click-Pin® system – for fast retooling of the knurling wheels
- Set screws in shank for clearance angle correction
- Carbide pin
- Modular shank design: Shank size 10 x 10 mm optionally adaptable

TOOL VERSIONS:

Order no.	Tool holder Designation	Working area Ø [mm]	Dimension [mm]							Knurling wheels (Ø x b x b) [mm]
			a	b	c	d	e	f	x	
31002706	131-10R150404-VS-A	3-50	10	10	99	12	19	17.5	1.5/4	10/15 x 4 x 4
31002707	131-12R150404-VS-A	3-50	12	12	99	12	19	19.5	1.5/4	10/15 x 4 x 4
31002708	131-16R150404-VS-A	3-50	16	16	99	19	19	23.5	1.5/4	10/15 x 4 x 4

Other variants available on request

Left-hand version of all shank dimensions available on request

Order no.	Tool holder Designation	Working area Ø [mm]	Dimension [mm]						Knurling wheels (Ø x b x b) [mm]
			a	b	c	e	f	x	
31000714	131-20U250806-A-Z	8-200	20	20	109.5	29.5	32.5	3/5.5	20/25 x 8 x 6
31000715	131-25U250806-A-Z	8-200	25	20	109.5	29.5	37.5	3/5.5	20/25 x 8 x 6

ADAPTER BRACKET FOR BASE SHANK 10 x 10 mm:

Order no.	Shank size [mm]
21BHR1653	12 x 12
21BHR1654	16 x 16

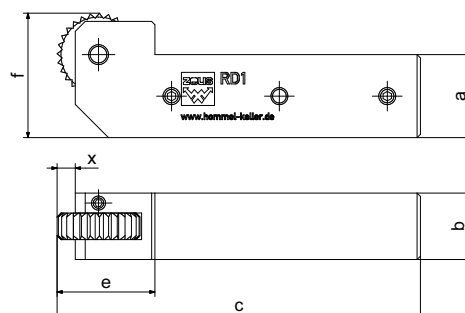
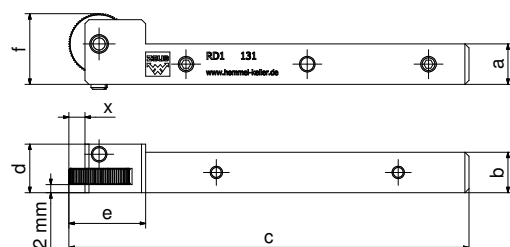



Series 132



Tool holder
Designation

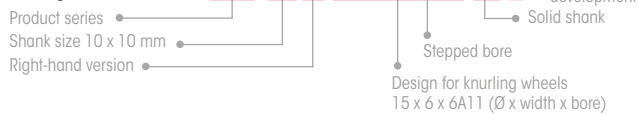

Knurling profiles on DIN 82 workpiece:

Plunge knurling

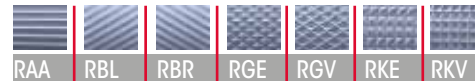

Selection of knurling wheels:



Feed knurling



Selection of knurling wheels:



Product features:

- Knurling wheel fixed by means of carbide collar studs
- Set screws in shank for clearance angle correction
- Modular shank design: Shank size 10 x 10 mm optionally adaptable

TOOL VERSIONS:

Order no.	Tool holder Designation	Working area Ø [mm]	Dimension [mm]							Knurling wheels (Ø x b x b) [mm]
			a	b	c	d	e	f	x	
31002726	132-10R150606A11-VS-A	3-50	10	10	101	19	21	18	1.3	15 x 6 x 6A11
31002227	132-12R150606A11-VS-A	3-50	12	12	101	19	21	20	1.3	15 x 6 x 6A11
31002729	132-16R150606A11-VS-A	3-50	16	16	101	19	21	24	1.3	15 x 6 x 6A11

Other variants available on request

Left-hand version of all shank dimensions available on request

Order no.	Tool holder Designation	Working area Ø [mm]	Dimension [mm]							Knurling wheels (Ø x b x b) [mm]
			a	b	c	d	e	f	x	
31000742	132-20U200806A13-A	8-200	20	20	105.5	24	25.3	30	1.3	20 x 8 x 6A13
31000743	132-25U200806A13-A	8-200	25	20	105.5	24	25.3	30	1.3	20 x 8 x 6A13

ADAPTER BRACKET FOR BASE SHANK 10 x 10 mm:

Order no.	Shank size [mm]
21BHR1653	12 x 12
21BHR1654	16 x 16

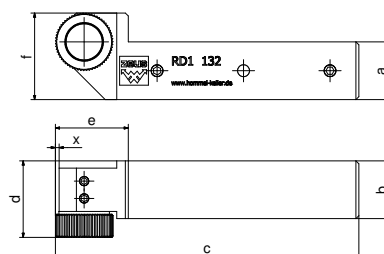
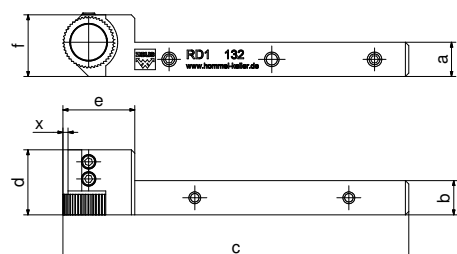

Series 141



Tool holder
Designation

141-10 M 100404-VS-A

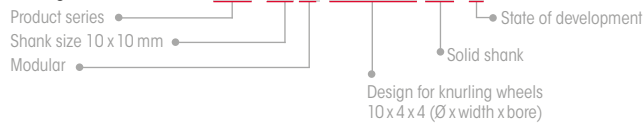

Knurling profiles on DIN 82 workpiece:

Plunge/feed knurling



Selection of knurling wheels:

2 x AA	2 x BR	2 x BL	1 x BL30°	1 x BL45°
			1 x BR30°	1 x BR45°

Product features:

- Shank size 20 x 20 mm and 25 x 25 mm with Click-Pin® system – for fast retooling of the knurling wheels
- Modular design: Tool can be used as right-hand and left-hand version
- Knurling head with flexible centring
- Set screws in shank for clearance angle correction
- Carbide pins
- Modular shank design: Shank size 10 x 10 mm optionally adaptable

TOOL VERSIONS:

Order no.	Tool holder Designation	Working area Ø [mm]	Dimension [mm]							Knurling wheels (Ø x b x b) [mm]
			a	b	c	d	e	f	x	
31002702	141-10M100404-VS-A	3-25	10	10	105.5	12	25.5	21	1	10 x 4 x 4
31002703	141-12M100404-VS-A	3-25	12	12	105.5	12	25.5	22.5	1	10 x 4 x 4
31002658	141-16M150404-VS-A	6-60	16	16	119	16	39	33	1.5	15 x 4 x 4
31000741	141-16M150604-VS-A	6-60	16	16	119	16	39	33	1.5	15 x 6 x 4

Other variants available on request

Order no.	Tool holder Designation	Working area Ø [mm]	Dimension [mm]							Knurling wheels (Ø x b x b) [mm]
			a	b	c	d	e	f	x	
31002704	141-20M200806-B	10-110	20	20	130	20	50	42	2.5	20 x 8 x 6
31002705	141-25M200806-B	10-110	25	20	130	20	50	46	2.5	20 x 8 x 6
31002721	141-25M250806-B	15-220	25	20	136	20	56	55	2.5	25 x 8 x 6

Tools of series 141 can be converted to series 142 and vice versa by replacing the knurling head, with a shank size of 16 x 16 mm or larger

ADAPTER BRACKET FOR BASE SHANK 10 x 10 mm:

Order no.	Shank size [mm]
21BHR1653	12 x 12
21BHR1654	16 x 16



KNURLING HEADS 142:

Order no. Series 142	Shank size [mm]	Knurling wheels (Ø x w x b) [mm]
21BHR0532	16 x 16	15 x 6 x 6A11
21BHR0533	20 x 20	20 x 8 x 6A13

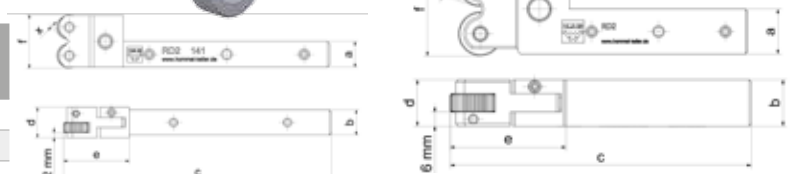

Series 142



Tool holder

Designation

142-20 M 200806A13-A



Knurling profiles on DIN 82 workpiece:

Plunge/feed knurling



Selection of knurling wheels

2 x AA	2 x BR	2 x BL	1 x BL30°	1 x BL45°
			1 x BR30°	1 x BR45°

Product features:

- Knurling wheels fixed by means of carbide collar studs
- Modular design: Tool can be used as right-hand and left-hand version. Retooling by simply turning the knurling head
- Knurling head with flexible centring
- Set screws in shank for clearance angle correction

TOOL VERSIONS:

Order no.	Tool holder Designation	Working area Ø [mm]	Dimension [mm]							Knurling wheels (Ø x b x b) [mm]
			a	b	c	d	e	f	x	
31002801	142-10M150606A11-VS-A	3-40	10	10	110	19	30	30.4	1.5	15 x 6 x 6A11
31002803	142-12M150606A11-VS-A	3-40	12	12	110	19	30	30.4	1.5	15 x 6 x 6A11
31000751	142-16M150606A11-A	6-60	16	16	119	19	39	33	1.5	15 x 6 x 6A11

Other variants available on request

Order no.	Tool holder Designation	Working area Ø [mm]	Dimension [mm]							Knurling wheels (Ø x b x b) [mm]
			a	b	c	d	e	f	x	
31000752	142-20M200806A13-A	10-110	20	20	130	24	50	42	2.4	20 x 8 x 6A13
31000753	142-25M200806A13-A	10-110	25	20	130	24	50	46	2.4	20 x 8 x 6A13

Tools of series 142 can be converted to series 141 and vice versa by replacing the knurling head, with a shank size of 16 x 16 mm or larger

ADAPTER BRACKET FOR BASE SHANK 10 x 10 mm:

Order no.	Shank size [mm]
21BHR1653	12 x 12
21BHR1654	16 x 16



KNURLING HEADS 141:

Order no. Series 141	Shank size [mm]	Knurling wheels (Ø x w x b) [mm]
21BHR0529	16 x 16	15 x 6 x 4
21BHR1795	20 x 20	20 x 8 x 6
21BHR1796	25 x 20	25 x 8 x 6

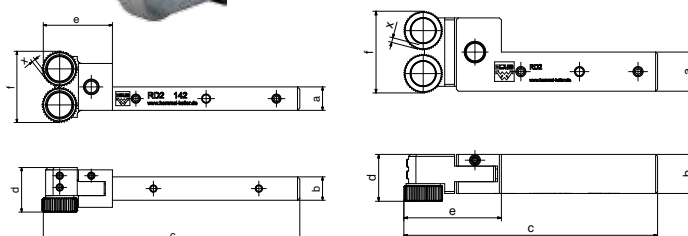

Ideal for very small workpiece diameters, features gentle tangential profiling

Series 161



Tool holder
Designation

161-10 R 150404-VS -A

Product series
Shank size 10 x 10 mm
Right-hand version
State of development
Solid shank
Design for knurling wheels
15 x 4 x 4 (Ø x width x bore)

Knurling profiles on DIN 82 workpiece:

Plunge/feed knurling



Selection of knurling wheels:

2 x AA	2 x BR	2 x BL	1 x BL30°	1 x BL45°
			1 x BR30°	1 x BR45°

Product features:

- Knurl holder is easily adjustable to workpiece diameter by means of synchronous spindle
- Set screws in shank for clearance angle correction
- Carbide pins with surface secured by set screw
- Modular shank design: Shank size 10 x 10 mm optionally adaptable

TOOL VERSIONS:

Order no.	Tool holder Designation	Working area Ø [mm]	Dimension [mm]							Knurling wheels (Ø x b x b) [mm]
			a	b	c	d	e	f	x	
31002719	161-10R150404-VS-A	0-15	10	10	113.4	19.6	33.4	40	2.5	15 x 4 x 4
31002722	161-12R150404-VS-A	0-15	12	12	113.4	19.6	33.4	40	2.5	15 x 4 x 4
31002724	161-16R150404-VS-A	0-15	16	16	113.4	19.6	33.4	40	2.5	15 x 4 x 4

Order no.	Tool holder Designation	Working area Ø [mm]	Dimension [mm]							Knurling wheels (Ø x b x b) [mm]	
			a	b	c	d	e	f	xa		x
31002127	161-20M250806	3.5-65	20	25	164.8	28.4	92.8	103	33.5	1.5	20 x 8 x 6
		0-65	20	25	167.3	28.4	95.3	103	33.5	4	25 x 8 x 6

Other variants available on request

Left-hand version of all shank dimensions available on request

ADAPTER BRACKET FOR BASE SHANK 10 x 10 mm:

Order no.	Shank size [mm]
21BHR1653	12 x 12
21BHR1654	16 x 16

JAWS:

Order no. Series 162	Shank size [mm]
21BHR1673	10 x 10/12 x 12/16 x 16
21BHR1214	20 x 25

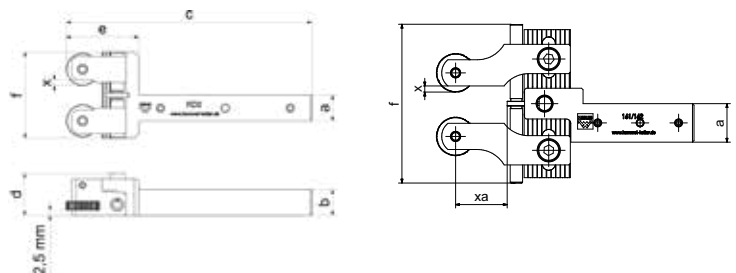

21BHR1214

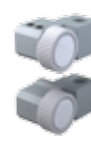

21BHR1673

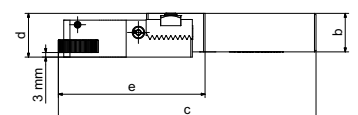

Series 162



Knurling profiles on DIN 82 workpiece:

Plunge/feed knurling

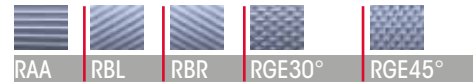

Selection of knurling wheels:

2 x AA	2 x BR	2 x BL	1 x BL30° / 1 x BR30°	1 x BL45° / 1 x BR45°
--------	--------	--------	--------------------------	--------------------------

Product features:

- Knurling wheels fixed by means of carbide collar studs
- Knurl holder is easily adjustable to workpiece diameter by means of synchronous spindle
- Set screws in shank for clearance angle correction
- Modular shank design: Shank size 10 x 10 mm optionally adaptable

Tool holder Designation

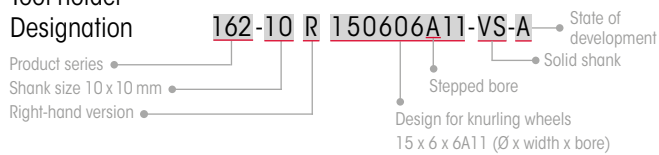

TOOL VERSIONS:

Order no.	Tool holder Designation	Working area Ø [mm]	Dimension [mm]							Knurling wheels (Ø x b x b) [mm]
			a	b	c	d	e	f	x	
31002713	162-10R150606A11-VS-A	0-15	10	10	113.4	20.6	33.4	40	2.5	15 x 6 x 6A11
31002714	162-12R150606A11-VS-A	0-15	12	12	113.4	20.6	33.4	40	2.5	15 x 6 x 6A11
31002715	162-16R150606A11-VS-A	0-15	16	16	113.4	20.6	33.4	40	2.5	15 x 6 x 6A11

Order no.	Tool holder Designation	Working area Ø [mm]	Dimension [mm]							Knurling wheels (Ø x b x b) [mm]	
			a	b	c	d	e	f	xa		x
31002128	162-20M200806A13	3.5-65	20	25	164.8	28.4	92.8	103	33.5	1.5	20 x 8 x 6A13

Other variants available on request

Left-hand version of all shank dimensions available on request

ADAPTER BRACKET FOR BASE SHANK 10 x 10 mm:

Order no.	Shank size [mm]
21BHR1653	12 x 12
21BHR1654	16 x 16

JAWS:

Order no. Series 161	Shank size [mm]
21BHR1672	10 x 10/12 x 12/16 x 16
21BHR1213	20 x 25

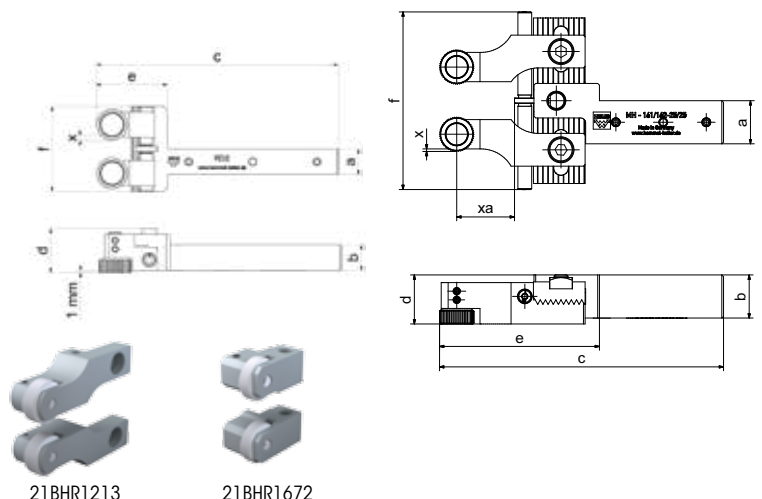

Series 191



Knurling profiles on DIN 82 workpiece:
Feed knurling

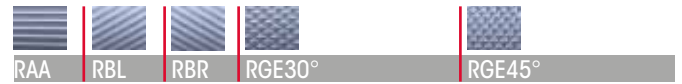

Selection of knurling wheels:

3 x AA	3 x BR	3 x BL	1 x BL30° / 2 x BR30° //	1 x BL45° / 2 x BR45° //
			1 x BR30° / 2 x BL30°	1 x BR45° / 2 x BL45°

Product features:

- Easy and precise fine adjustment
- Modular exchangeable knurl holder jaws for conversion to knurling up to a shoulder (192) or a cut knurling tool (291)
- Carbide pins

Tool holder
Designation

191 - 12M 150404 - B



TOOL VERSIONS:

Order no.	Tool holder Designation	Working area Ø [mm]	Dimension [mm]											Knurling wheels (Ø x b x b) [mm]
			a Ø	d max.Ø	e	h	i Ø	j Ø	k Ø	l	n max.	x Ø		
31001902	191-12M150404-B	2-13.5	12	57	78	45	9	16	54	9	56	1.5	10 x 4 x 4	
		3-8.5	12	57	78	45	9	16	54	9	56	4	15 x 4 x 4	

Other variants available on request

d = for max. workpiece Ø

n = max. workpiece length (with Ø)

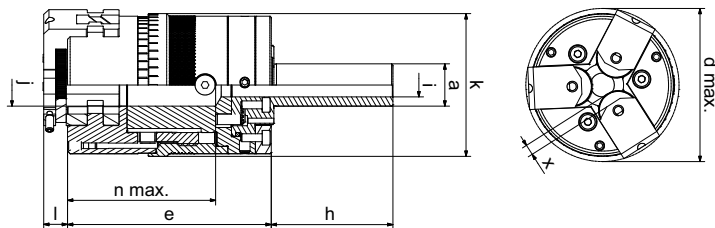

JAWS:

Order no. Form knurling up to a shoulder	Order no. Cut knurling
21BHR1128	21BHR1127

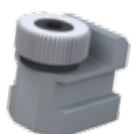

Series 192



Knurling profiles on DIN 82 workpiece:

Feed knurling



Selection of knurling wheels:

3 x AA	3 x BR	3 x BL	1 x BL30° / 2 x BR30° //	1 x BL45° / 2 x BR45° //
			1 x BR30° / 2 x BL30°	1 x BR45° / 2 x BL45°

Product features:

- Easy and precise fine adjustment
- Modular exchangeable knurl holder jaws for conversion to a form knurling tool (191) or a cut knurling tool (291)
- Carbide collar studs

Tool holder Designation

- Product series
- Shank size $\varnothing 12$
- Modular

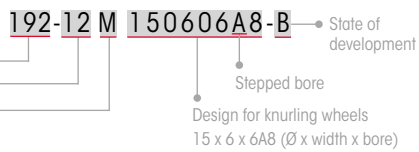

TOOL VERSIONS:

Order no.	Tool holder Designation	Working area \varnothing [mm]	Dimension [mm]										Knurling wheels (\varnothing x b x b) [mm]
			a \varnothing	d max. \varnothing	e	h	i \varnothing	j \varnothing	k \varnothing	l	n max.	x \varnothing	
31001948	192-12M150606A8-B	3-12	12	57	78	45	9	16	54	2	56	2.5	15 x 6 x 6A8

Other variants available on request

d = for max. workpiece \varnothing

n = max. workpiece length (with \varnothing)

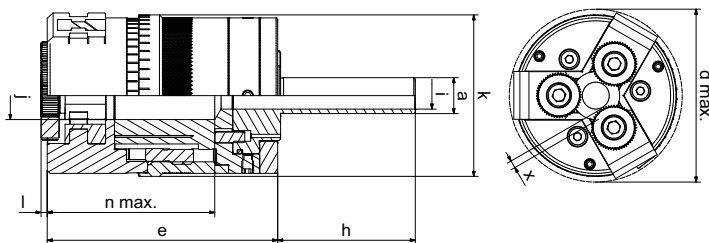

JAWS:

Order no. Form knurling	Order no. Cut knurling
21BHR1096	21BHR1127



Set 100-12



SET consisting of:

- 1 x tool: 131
- 3 x knurling wheel:
15 x 4 x 4 mm
- 3 x profile: AA
- Pitches: 0.5/0.6/0.8 mm



- 1 x tool: 141
- 12 x knurling wheel:
10 x 4 x 4 mm
- 6 x profile: AA
- 3 x profile: BL30°
- 3 x profile: BR30°
- Pitches: 0.5/0.6/0.8 mm

Knurling profiles on DIN 82 workpiece for tool 131:
Plunge/feed knurling



Selection of knurling wheels:



Knurling profiles on DIN 82 workpiece for tool 141:
Plunge/feed knurling

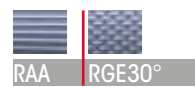

Selection of knurling wheels:



TOOL VERSIONS:

Order no. Set	Order no. Holder	Tool holder Designation	Working area Ø [mm]	Dimension [mm]	Knurling wheels (Ø x b x b) [mm]
31002691	31002707	131-12R150404-VS-A	3-50	see page 10	10/15 x 4 x 4
	31002703	141-12M100404-VS-A	3-25	see page 12	10 x 4 x 4

Set 100-16



SET consisting of:

- 1 x tool: 131
- 3 x knurling wheel:
15 x 4 x 4 mm
- 3 x profile: AA
- Pitches: 0.6/0.8/1.0 mm



- 1 x tool: 141
- 12 x knurling wheel:
10 x 4 x 4 mm
- 6 x profile: AA
- 3 x profile: BL30°
- 3 x profile: BR30°
- Pitches: 0.6/0.8/1.0 mm

Knurling profiles on DIN 82 workpiece for tool 131:
Plunge/feed knurling



Selection of knurling wheels:



Knurling profiles on DIN 82 workpiece for tool 141:
Plunge/feed knurling



Selection of knurling wheels:



TOOL VERSIONS:

Order no. Set	Order no. Holder	Tool holder Designation	Working area Ø [mm]	Dimension [mm]	Knurling wheels (Ø x b x b) [mm]
31002694	31002708	131-16R150404-VS-A	3-50	see page 10	10/15 x 4 x 4
	31002658	141-16M150404-VS-A	6-60	see page 12	15 x 4 x 4

Set 100-20



SET consisting of:

- 1 x tool: 131
- 3 x knurling wheel: 20 x 8 x 6 mm
- 3 x profile: AA
- Pitches: 0.8/1.0/1.5 mm

Knurling profiles on DIN 82 workpiece for tool 131:
Plunge/feed knurling



Selection of knurling wheels:



- 1 x tool: 141
- 12 x knurling wheel: 20 x 8 x 6 mm
- 6 x profile: AA
- 3 x profile: BL30°
- 3 x profile: BR30°
- Pitches: 0.8/1.0/1.5 mm

Knurling profiles on DIN 82 workpiece for tool 141:
Plunge/feed knurling

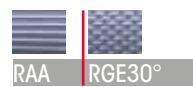

Selection of knurling wheels:



TOOL VERSIONS:

Order no. Set	Order no. Holder	Tool holder Designation	Working area Ø [mm]	Dimension [mm]	Knurling wheels (Ø x b x b) [mm]
31002695	31000714	131-20U250806-A-Z	8-200	see page 10	20/25 x 8 x 6
	31002704	141-20M200806-B	10-110	see page 12	20 x 8 x 6

Set 100-25



SET consisting of:

- 1 x tool: 131
- 3 x knurling wheel: 20 x 8 x 6 mm
- 3 x profile: AA
- Pitches: 0.8/1.0/1.5 mm

Knurling profiles on DIN 82 workpiece for tool 131:
Plunge/feed knurling



Selection of knurling wheels:



- 1 x tool: 141
- 12 x knurling wheel: 20 x 8 x 6 mm
- 6 x profile: AA
- 3 x profile: BL30°
- 3 x profile: BR30°
- Pitches: 0.8/1.0/1.5 mm

Knurling profiles on DIN 82 workpiece for tool 141:
Plunge/feed knurling

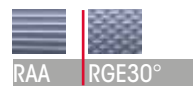

Selection of knurling wheels:



TOOL VERSIONS:

Order no. Set	Order no. Holder	Tool holder Designation	Working area Ø [mm]	Dimension [mm]	Knurling wheels (Ø x b x b) [mm]
31002696	31000715	131-25U250806-A-Z	8-200	see page 10	20/25 x 8 x 6
	31002705	141-25M200806-B	10-110	see page 12	20 x 8 x 6



zeus
Cut knurling
tools



Series 231



Tool holder Designation

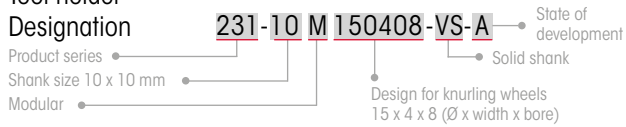

Knurling profiles on DIN 82 workpiece:
Feed knurling



Selection of knurling wheels:

1 x BR30° (right-hand use)	1 x AA (left-hand use)	1 x AA (right-hand use)
1 x BL30° (left-hand use)		

Product features:

- Scaling and positioning aids
- Adjusting spindle for fine adjustment of the knurl profile
- Set screws in shank for clearance angle correction
- Coated carbide bearing bushes for improved antifrictional property
- Modular shank design: Shank size 10 x 10 mm optionally adaptable

TOOL VERSIONS:

Order no.	Tool holder Designation	Working area Ø [mm]	Dimension [mm]							Knurling wheels (Ø x w x b) [mm]
			a	b	c	d	e	f	x	
31002739	231-10M150408-VS-A	3-50	10	10	103.5	36.2	23.9	25.3	1.4	15 x 4 x 8
31002740	231-12M150408-VS-A	3-50	12	12	103.5	36.2	23.9	25.3	1.4	15 x 4 x 8
31002741	231-16M150408-VS-A	3-50	16	16	103.5	36.2	23.9	29.3	1.4	15 x 4 x 8

Order no.	Tool holder Designation	Working area Ø [mm]	Dimension [mm]							Knurling wheels (Ø x w x b) [mm]
			a	b	c	d	e	f	x	
31002652	231-20M250608-B	10-300	20	20	130.8	35	50.8	36.5	3.7	25 x 6 x 8
31002445	231-25M250608-B	10-300	25	20	130.8	35	50.8	40	3.7	25 x 6 x 8

Other variants available on request

ADAPTER BRACKET FOR BASE SHANK 10 x 10 mm:

Order no.	Shank size [mm]
21BHR1653	12 x 12
21BHR1654	16 x 16

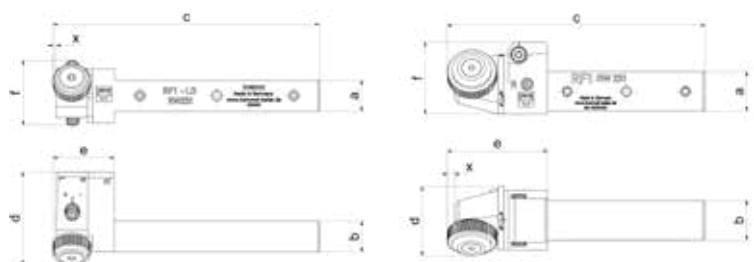

Series 241



Tool holder
Designation



Knurling profiles on DIN 82 workpiece:
Feed knurling

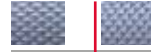

RGE30° RGE45°

Selection of knurling wheels:

2 x AA | 1 x BL15° / 1 x BR15°

Product features:

- Modular design: Tool can be used as right-hand and left-hand version. Retooling by simply turning the cut knurling head
- Conversion to alternative full shank dimensions is possible
- Modular shank design: Shank size 10 x 10 mm optionally adaptable
- Fine adjustment of centre height of the cut knurling head
- Fine adjustment of the clearance angle by means of synchronous adjustment spindle
- Coated carbide bearing bushes for improved anti-frictional property
- Vertical height adjustment for use of shank size 20 mm on 25 mm (version 241-20M250608-A1)

TOOL VERSIONS:

Order no.	Tool holder Designation	Working area Ø [mm]	Dimension [mm]						Knurling wheels (Ø x w x b) [mm]
			a	b	c	d	e	f	
31001926	241-10M150408-VS-A	3-50	10	10	116	36.7	36	31	15 x 4 x 8
31001901	241-12M150408-VS-A	3-50	12	12	116	37.7	36	31	15 x 4 x 8
31001945	241-16M150408-VS-A	3-50	16	16	116	39.7	36	31	15 x 4 x 8

Other variants available on request

Order no.	Tool holder Designation	Working area Ø [mm]	Dimension [mm]						Knurling wheels (Ø x w x b) [mm]
			a	b	c	d	e	f	
31000804	241-20M150408-A	3-50	20	20	116	44.7	36	35.6	15 x 4 x 8
31000666	241-20M250608-A1	10-250	20	20	133.3	68	53.3	53	25 x 6 x 8
31001899	241-25M250608-A1	10-250	25	20	133.3	68	53.3	53	25 x 6 x 8

ADAPTER BRACKET FOR BASE SHANK 10 x 10 mm:

Order no.	Shank size [mm]
21BHR1653	12 x 12
21BHR1654	16 x 16



Series 291



Knurling profiles on DIN 82 workpiece:

Feed knurling



RGE30° RGE45°

Selection of knurling wheels:

3 x AA | 1 x BL15° / 2 x BR15° oder
1 x BR15° / 2 x BL15°

Product features:

- Easy and precise fine adjustment
- Modular exchangeable knurl holder jaws for conversion to a form knurling tool 191 / 192 (knurling up to a shoulder)
- Coated carbide bearing bushes for improved antifrictional property

Tool holder Designation

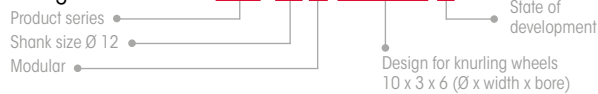

TOOL VERSIONS:

Order no.	Tool holder Designation	Working area Ø [mm]	Dimension [mm]										Knurling wheels (Ø x w x b) [mm]
			a Ø	d max. Ø	e	h	i Ø	j Ø	k Ø	l	n max.	x Ø	
31001946	291-12M100306-B	3.5-13.5	12	57	78	45	9	16	54	3	56	1	10 x 3 x 6

Other variants available on request

d = for max. workpiece Ø

n = max. workpiece length (with Ø)

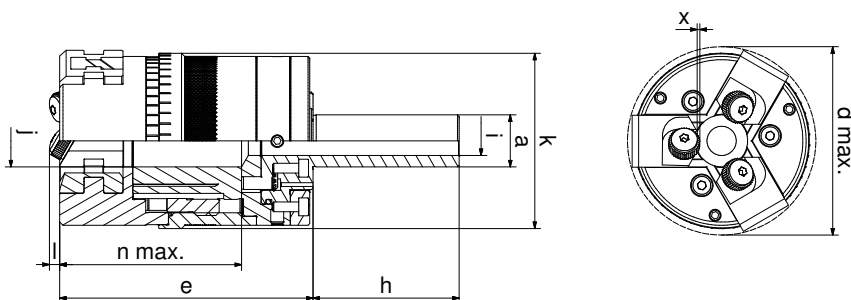

JAWS:

Order no. Form knurling	Order no. Cut knurling up to a shoulder
21BHR1096	21BHR1128



Cut knurling tools SETS

Best efficiency in combination –
the perfect standard equipment

Set 200-12



SET consisting of:

- 1 x tool: 231
- 6 x knurling wheel:
15 x 4 x 8 mm
- 3 x profile: BL30°
- 3 x profile: BR30°
- Pitches: 0.5/0.6/0.8 mm



- 1 x tool: 241
- 6 x knurling wheel:
15 x 4 x 8 mm
- 6 x profile: AA
- Pitches: 0.5/0.6/0.8 mm

Knurling profiles on DIN 82 workpiece for tool 231:

Feed knurling



Selection of knurling wheels:

1 x BR30° (right-hand use)	1 x AA (left-hand use)	1 x AA (right-hand use)
1 x BL30° (left-hand use)		

Knurling profiles on DIN 82 workpiece for tool 241:

Feed knurling



Selection of knurling wheels:

2 x AA

TOOL VERSIONS:

Order no. Set	Order no. Holder	Tool holder Designation	Working area Ø [mm]	Dimension [mm]	Knurling wheels (Ø x b x b) [mm]
31002697	31002740	231-12M150408-VS-A	3-50	see page 21	15 x 4 x 8
	31001901	241-12M150408-VS-A	3-50	see page 22	15 x 4 x 8

Set 200-16



SET consisting of:

- 1 x tool: 231
- 6 x knurling wheel:
15 x 4 x 8 mm
- 3 x profile: BL30°
- 3 x profile: BR30°
- Pitches: 0.6/0.8/1.0 mm



- 1 x tool: 241
- 6 x knurling wheel:
15 x 4 x 8 mm
- 6 x profile: AA
- Pitches: 0.6/0.8/1.0 mm

Knurling profiles on DIN 82 workpiece for tool 231:

Feed knurling



Selection of knurling wheels:

1 x BR30° (right-hand use)	1 x AA (left-hand use)	1 x AA (right-hand use)
1 x BL30° (left-hand use)		

Knurling profiles on DIN 82 workpiece for tool 241:

Feed knurling



Selection of knurling wheels:

2 x AA

TOOL VERSIONS:

Order no. Set	Order no. Holder	Tool holder Designation	Working area Ø [mm]	Dimension [mm]	Knurling wheels (Ø x b x b) [mm]
31002698	31002741	231-16M150408-VS-A	3-50	see page 21	15 x 4 x 8
	31001945	241-16M150408-VS-A	3-50	see page 22	15 x 4 x 8

Set 200-20



SET consisting of:

- 1 x tool: 231
- 6 x knurling wheel: 25 x 6 x 8 mm
- 3 x profile: BL30°
- 3 x profile: BR30°
- Pitches: 0.8/1.0/1.5 mm



- 1 x tool: 241
- 6 x knurling wheel: 25 x 6 x 8 mm
- 6 x profile: AA
- Pitches: 0.8/1.0/1.5 mm

TOOL VERSIONS:

Order no. Set	Order no. Holder	Tool holder Designation	Working area Ø [mm]	Dimension [mm]	Knurling wheels (Ø x b x b) [mm]
31002699	31002652	231-20M250608-B	10-300	see page 21	25 x 6 x 8
	31000666	241-20M250608-A1	10-250	see page 22	25 x 6 x 8

Knurling profiles on DIN 82 workpiece for tool 231:

Feed knurling



Selection of knurling wheels:

1 x BR30° (right-hand use)	1 x AA (left-hand use)	1 x AA (right-hand use)
1 x BL30° (left-hand use)		

Knurling profiles on DIN 82 workpiece for tool 241:

Feed knurling



Selection of knurling wheels:

2 x AA

Set 200-25



SET consisting of:

- 1 x tool: 231
- 6 x knurling wheel: 25 x 6 x 8 mm
- 3 x profile: BL30°
- 3 x profile: BR30°
- Pitches: 0.8/1.0/1.5 mm



- 1 x tool: 241
- 6 x knurling wheel: 25 x 6 x 8 mm
- 6 x profile: AA
- Pitches: 0.8/1.0/1.5 mm

Knurling profiles on DIN 82 workpiece for tool 231:

Feed knurling



Selection of knurling wheels:

1 x BR30° (right-hand use)	1 x AA (left-hand use)	1 x AA (right-hand use)
1 x BL30° (left-hand use)		

Knurling profiles on DIN 82 workpiece for tool 241:

Feed knurling



Selection of knurling wheels:

2 x AA

TOOL VERSIONS:

Order no. Set	Order no. Holder	Tool holder Designation	Working area Ø [mm]	Dimension [mm]	Knurling wheels (Ø x b x b) [mm]
31002700	31002445	231-25M250608-B	10-300	see page 21	25 x 6 x 8
	31001899	241-25M250608-A1	10-250	see page 22	25 x 6 x 8



zeus

Special tools and interfaces

Series 391



Ø 25 mm



Ø 30 mm

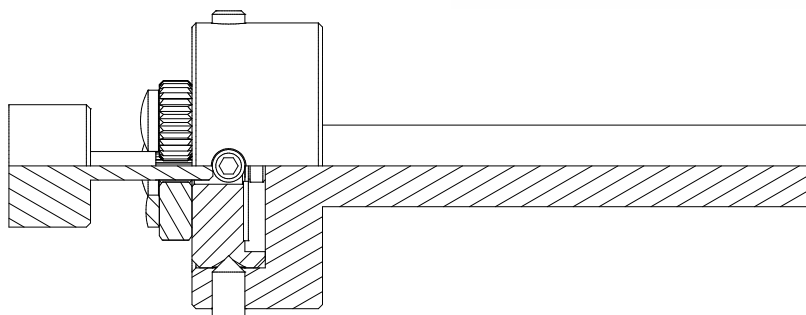

Knurling profiles on DIN 82 workpiece:

Feed knurling



Selection of knurling wheels:



Product features:

- No lateral contact pressures – minimum load on the workpiece
- Custom production – designed for workpiece diameter and pitch
- Dimensions correspond to standard for thread-cutting dies
- For use in standardised thread-cutting die holders
- Base shanks are not included in scope of delivery, but are available on request

Available sizes:

- Ø 25 mm
- Ø 30 mm
- Ø 38 mm
- Ø 45 mm
- Ø 55 mm

Special tools

Series 311-xx°

Conical knurling
Face knurling

Conical/inner/face knurling
up to a shoulder



20° - 60°

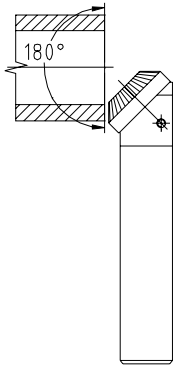

90°

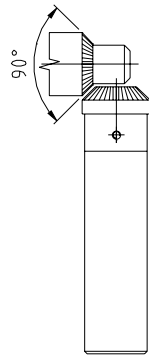

Knurling profiles on DIN 82 workpiece:

Plunge knurling



Selection of knurling wheels:



Series 312-xx°

Conical knurling



1° - 60°

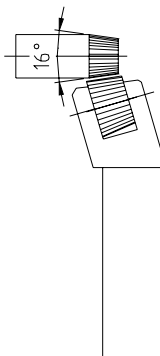

Knurling profiles on DIN 82 workpiece:

Plunge knurling



Selection of knurling wheels:



Series 330

Knurling within a bore

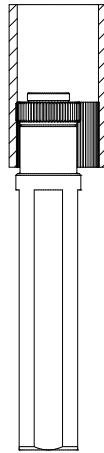

Knurling profiles on DIN 82 workpiece:

Plunge knurling

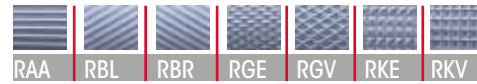

Selection of knurling wheels:



Feed knurling



Selection of knurling wheels:



Series 332

Knurling within a bore up to a shoulder

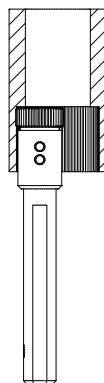

Knurling profiles on DIN 82 workpiece:

Plunge knurling



Selection of knurling wheels:



Feed knurling



Selection of knurling wheels:



Series 342

Knurling within a bore up to a shoulder

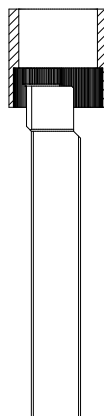

Knurling profiles on DIN 82 workpiece:

Plunge knurling



Selection of knurling wheels:



Feed knurling



Selection of knurling wheels:



Special interfaces



Characteristics:

- Standardised to DIN 69871 with retention knob
- Torque transmission by means of the friction contact of the taper with low strain
- For larger torques and sudden loads, driving keys are primarily responsible for the transmission
- The driving keys are arranged asymmetrically on the spindle face for clear orientation for the tool
- Easy production
- Self-centring due to steep taper
- High speeds can expand the spindle cone and the resulting centrifugal force can cause axial distortion of the tool
- The centrifugal force distortion reduces the contact surfaces and therefore the frictional transmission of torques



Characteristics:

- Standardised to DIN 69893
- No retention nob
- Smaller (ca. 30%) and lighter (ca. 50%) than the steep taper (SK)
- Faster and easier tool change
- Rigidity 5 to 7 times higher than with steep taper holders due to support on the tool holder over the collar
- Force-closing due to the taper and contact surface
- Form-closing by means of drive slots
- Excellent change accuracy (3 μm)
- Face contact on collar ensures axial wobble accuracy
- Close taper tolerance minimises radial run-out
- HSK-C has a shorter shank with a flatter taper angle

Special interfaces



Characteristics:

- Transmission of high torques
- High bending strength
- Central supply of high-pressure cooling lubricant from the machine to the cutting edge
- Balanced and concentric
- Self-centring
- Flexible due to high level of modularity
- High basic stability and accuracy
- Reduced setup time



Characteristics:

- Universal tool system for all production areas
- Tool change within seconds
- Form-closing for reliable torque transmission
- Very short design
- Internal coolant supply is possible
- Presetting of tools outside the machine
- Tool holders in different sizes
- High rigidity

GRAF holding systems



Characteristics:

- Tool change within seconds
- Very short design
- Presetting of tools outside the machine
- Tool holders in different sizes
- High rigidity

Special tools

Series 161-S

Integrated turret holder
Expanded work area



Knurling profiles on DIN 82 workpiece:
Plunge knurling



Selection of knurling wheels:

2 x AA	1 x BL30°	1 x BL45°
	1 x BR30°	1 x BR45°

Product features:

- Flexible work area
- Extremely stable design
- Direct machine connection
- Conical application
- Carbide pins

Working area:

- Ø 0–15 mm

Series 161-S

Conical knurling
Adjustable jaws 4–12°



Knurling profiles on DIN 82 workpiece:
Plunge/feed knurling



Selection of knurling wheels:

2 x AA	2 x BL	2 x BR	1 x BL30°	1 x BL45°
			1 x BR30°	1 x BR45°

Product features:

- Adjustable jaws 4–12°
- Star turret holder
- Flexible work area – conical surfaces
- Reduced strain on workpiece and machine
- Knurling head with flexible centring
- Modular shank design
- Carbide pin

Working area:

- Ø 8–36 mm

Series 161-S

Knurling wheels in special size/form



Knurling profiles on DIN 82 workpiece:
Plunge/feed knurling



Selection of knurling wheels:

2 x AA	2 x (1 x) BL30°/ 1 x (2 x) BR30°	2 x (1 x) BL45°/ 1 x (2 x) BR45°
--------	-------------------------------------	-------------------------------------

Product features:

- HSK holder
- No lateral contact pressure – reduced load
- Centre height adjustable due to synchronous spindle
- Carbide pins

Working area:

- Ø 0–20 mm

Series 142-S

Special Capto® holder



Knurling profiles on DIN 82 workpiece:

Plunge/feed knurling



Selection of knurling wheels:

2 x AA	1 x BL30°	1 x BL45°
	1 x BR30°	1 x BR45°

Product features:

- Knurling up to a shoulder
- Capto holder
- Knurling head with flexible centring
- Modularity – application independent
- Carbide pins

Working area:

- Ø 10–80 mm

Series 192-S

Special HSK 32 holder



Knurling profiles on DIN 82 workpiece:

Feed knurling



Selection of knurling wheels:

2 x AA	2 x (1 x) BL30° /	2 x (1 x) BL45° /
	1 x (2 x) BR30°	1 x (2 x) BR45°

Product features:

- Knurling up to a shoulder
- HSK holder
- No lateral contact pressure – reduced load
- Modular exchangeable knurl holder jaws
- Suitable for very small workpieces
- Exchangeable shank
- Easy and precise fine adjustment (synchronous)
- Carbide pins/bearing bolts

Working area:

- Ø 4–30 mm

Form knurling/ marking

Special facing slide head holder



Knurling profiles on DIN 82 workpiece:

Plunge/feed knurling



Selection of knurling wheels:

1 x AA	2 x BL	2 x BR	1 x BL30°	1 x BL45°
			1 x BR30°	1 x BR45°

Product features:

- Holder for facing slide head
- Special width for custom applications (knurling wheel/marking roll)
- Carbide pins

Working area:

- Dependent on facing slide head

A close-up, low-angle shot of a knurling wheel, showing its characteristic diamond-shaped ridges. The wheel is positioned diagonally across the frame, with the top-left corner being the most brightly lit, creating a strong contrast with the deep shadows in the valleys between the ridges. The background is a solid, dark black, which makes the metallic texture of the wheel stand out. The lighting is directional, highlighting the sharp edges and the fine details of the knurling process.

ZEUS

Knurling wheels

Profiles and knurling pitches



DIN 403 describes and specified the knurling profile on the knurling wheel.
 DIN 403 defines knurling forms AA, BL, BR, GE, GV, KE and KV. Knurling wheels that deviate from DIN 403 are considered special knurling tools and are custom manufactured by Hommel+Keller based on customer drawings.

AA Knurling wheel with axially parallel grooves

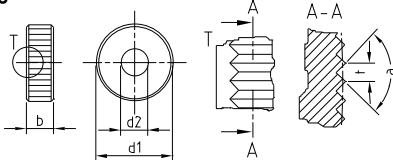

BL Left-hand knurling wheel

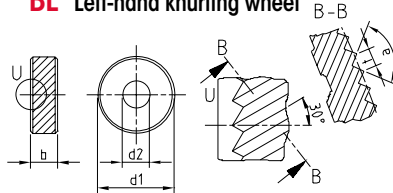

BR Right-hand knurling wheel

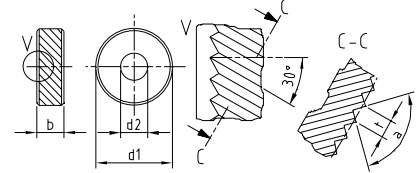

GE Left/right-hand knurling wheel, raised points, 30°

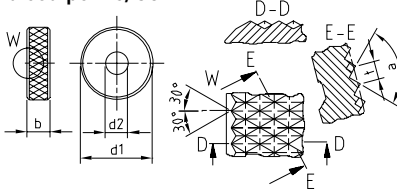

GV Left/right-hand knurling wheel, lowered points, 30°

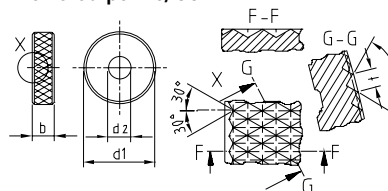

KE Cross knurling wheel, raised points, 90°

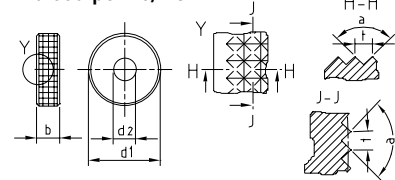

KV Cross knurling wheel, lowered points, 90°

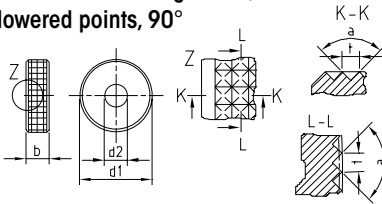

The knurling profile on the knurling wheel according to DIN 403 is based on the desired knurling profile on the workpiece (DIN 82) and the tool holder that is used.

The knurling pitch p refers to the distance between tooth crests. The pitches = 0.5/0.6/0.8/1.0/1.2/1.6 are standardised according to DIN 403. The Hommel+Keller product spectrum includes other pitches as well. They are listed below in mm and TPI. Other pitches are available as custom manufactured versions.

Standard pitches from Hommel+Keller

mm 0.3	0.4	0.5	0.6	0.7	0.8	mm 0.3	0.4	0.5	0.6	0.7	0.8
TPI 84.7	63.5	50.8	42.3	36.3	31.8	TPI 84.7	63.5	50.8	42.3	36.3	31.8
mm 1.0	1.2	1.5	1.6	2.0		mm 1.0	1.2	1.5	1.6	2.0	
TPI 25.4	21.2	16.9	15.9	12.7		TPI 25.4	21.2	16.9	15.9	12.7	

Form knurling – non-cutting process



Knurling wheels, milled, with 45° chamfer – PM

Standard variants	Profile		Dimension [mm]			Pitches [mm]		
			Ø	Width	Bore			
No. 11	AA		10	4	4	○		
No. 11			15	4	4	○		
No. 11			15	6	4	○		
No. 11			15	6	6A8	□		
No. 11			15	6	6A11	□		
No. 11			20	6	6	○		
No. 11			20	8	6	●		
No. 11			20	8	6A13	□		
No. 11			20	10	6	□		
No. 11			25	6	6	□		
No. 11			25	8	6	□		
No. 11			25	10	6	□		
No. 11			BL	30°	10	4	4	○
No. 11					15	4	4	□
No. 11	20	6			6	□		
No. 11	20	8			6	■		
No. 11	BL	45°	10	4	4	□		
No. 11			15	4	4	□		
No. 11	BR	30°	10	4	4	○		
No. 11			15	4	4	□		
No. 11			20	6	6	□		
No. 11		20	8	6	□			
No. 11		BR	45°	10	4	4	□	
No. 11				15	4	4	□	
No. 11	20			8	6	□		

Standard pitches/profile angle 90°

- 0.3/0.4/0.5/0.6/0.7/0.8/1.0/1.2/1.5/1.6/2.0
- 0.3/0.4/0.5/0.6/0.7/0.8/1.0/1.2/1.5
- 0.5/0.6/0.8/1.0/1.2/1.5/1.6/2.0
- 0.5/0.6/0.8/1.0/1.2/1.5
- ◆ 0.5/0.6/0.8/1.0
- ☑ On request

Other variants available on request

Variants

Knurling wheel variants (PM)

No.	Version
13	milled, without chamfer
30	ground with 45° chamfer
32	ground, without chamfer
95	milled, with 60° chamfer

Knurling wheel variants (HSS)

No.	Version
10	milled, with 45° chamfer
12	milled, without chamfer
94	milled, with 60° chamfer

Knurling wheel variants (HM)

No.	Version
50	ground with 45° chamfer
52	ground, without chamfer

Form knurling with 60° chamfer

When forming knurling profiles with a larger pitch in the axial machining direction it can be advantageous to apply a 60° chamfer to the knurling wheel. The flatter chamfer achieves a better material flow.

Wheel geometries – see "Technology", page 44

Form knurling – non-cutting process



Knurling wheels, milled, with 45° chamfer – PM

Standard variants	Profile		Dimension [mm]			Pitches [mm]
			Ø	Width	Bore	
No. 11	GE	30°	15	4	4	◆
No. 11			15	6	4	◆
No. 11			20	6	6	◆
No. 11			20	8	6	□
No. 11	GE	45°	20	8	6	□
No. 11	KE		☑	☑	☑	☑

Variants

Knurling wheel variants (PM)

No.	Version
13	milled, without chamfer
30	ground with 45° chamfer
32	ground, without chamfer

Knurling wheel variants (HSS)

No.	Version
10	milled, with 45° chamfer
12	milled, without chamfer

Knurling wheel variants (HM)

No.	Version
50	ground with 45° chamfer
52	ground, without chamfer

Standard pitches/profile angle 90°

- 0.3/0.4/0.5/0.6/0.7/0.8/1.0/1.2/1.5/1.6/2.0
- 0.3/0.4/0.5/0.6/0.7/0.8/1.0/1.2/1.5
- 0.5/0.6/0.8/1.0/1.2/1.5/1.6/2.0
- 0.5/0.6/0.8/1.0/1.2/1.5
- ◆ 0.5/0.6/0.8/1.0
- ☑ On request

Other variants available on request



Knurling wheels, formed, with 45° chamfer – PM

Standard variants	Profile		Dimension [mm]			Pitches [mm]
			Ø	Width	Bore	
No. 21	GV	30°	15	4	4	◆
No. 21			15	6	4	◆
No. 21			20	6	6	◆
No. 21			20	8	6	□
No. 21	GV	45°	20	8	6	◆
No. 21	KV		☑	☑	☑	☑

Variants

Knurling wheel variants (PM)

No.	Version
23	formed, without chamfer

Knurling wheel variants (HSS)

No.	Version
20	formed, with 45° chamfer
22	formed, without chamfer

Cut knurling – cutting process



Knurling wheels, milled, without chamfer – PM

Standard variants	Profile		Dimension [mm]			Pitches [mm]
			Ø	Width	Bore	
No. 16	AA		8.9	2.5	4	○
No. 16			10	3	6	○
No. 16			14.5	3	5	■
No. 16			15	4	8	○
No. 16			21.5	5	8	■
No. 16			25	6	8	■
No. 16	BL	15°	10	3	6	◆
No. 16			15	4	8	□
No. 16			21.5	5	8	□
No. 16	BL	30°	25	6	8	■
No. 16			10	3	6	◆
No. 16			14.5	3	5	◆
No. 16			15	4	8	○
No. 16	BR	15°	21.5	5	8	□
No. 16			25	6	8	■
No. 16			10	3	6	◆
No. 16			15	4	8	□
No. 16	BR	30°	21.5	5	8	□
No. 16			25	6	8	■
No. 16			10	3	6	◆
No. 16			14.5	3	5	◆

Standard pitches/profile angle 90°

- 0.3/0.4/0.5/0.6/0.7/0.8/1.0/1.2/1.5/1.6/2.0
- 0.3/0.4/0.5/0.6/0.7/0.8/1.0/1.2/1.5
- 0.5/0.6/0.7/0.8/1.0/1.2/1.5/2.0
- 0.5/0.6/0.8/1.0/1.2/1.5
- ◆ 0.5/0.6/0.8/1.0
- ☑ On request

Other variants available on request

Variants

Knurling wheel variants (PM)

N°	Version
18	milled, with 10° chamfer
35	ground, without chamfer
37	ground with 10° chamfer

Knurling wheel variants (HSS)

N°	Version
15	milled, without chamfer
17	milled, with 10° chamfer

Knurling wheel variants (HM)

N°	Version
55	ground, without chamfer
57	ground with 10° chamfer

Form knurling – with 10° chamfer

When cutting knurling profiles with a larger pitch in the axial machining direction it can be advantageous to apply a 10° chamfer to the knurling wheel.

For wheel geometries, see "Technology" on page 44

Special knurling wheels



HV



HHV

Bead knurl – No. 60

Note: Please indicate the bead diameter when ordering.



KAA



KGE



KBR



KBL

Conical knurling wheels – No. 70

Note: The completeness of the teeth on the workpiece is always dependent on the width/pitch of the knurling wheel.



C*



DL 20° *



DR 20° *

* Only radiuses > 3 mm are possible.



E



FL 20°



FR 20°

In the DL, DR, FL and FR versions the spiral angle must not exceed 20°.

Concave and convex knurling wheels – No. 80



Nr. 90



Nr. 92



Nr. 93

Note: The picture of knurling wheel no. 90 is provided as an example. It represents all special forms not covered by no. 92 (single stepped) and no. 93 (double stepped).

Special knurling wheels – No. 90/92/93

Burnishing rolls



RRA



RRE

zeus burnishing rolls can be used in standard zeus form knurling tools. On request, we can develop and produce a custom holding system.

Use in this tool system is suitable for machining cylindrical workpieces, bores, end faces, conical workpieces and for convex and concave outer contours.

Applications:

zeus burnishing rolls are used primarily for roller-burnishing and supporting round material during machining on lathes.

Result:

- Improved surface quality
- Increased dimensional stability
- Increased hardness of surfaces

Advantages:

- Burnished workpieces exhibit low friction and increased resistance to corrosion after machining
- Reworking, such as grinding, honing and lapping can be replaced by simple roller-burnishing machining
- When used as support rolls, they reduce wear on the bearings and clamping devices and minimise the pressure on the workpiece

Burnishing roll type RRA – cylindrical

Type	Dimension [mm]			Version		
	Ø	Width	Bore	N° 04 turned & polished, Rz 4 µm	N° 05 ground, Rz 2–3 µm	N° 06 ground & polished, Rz 1 µm
RRA	10	4	4	✓	✓	✓
	15	4	4	✓	✓	✓
	20	8	6	✓	✓	✓
	25	8	6	✓	✓	✓

Burnishing roll type RRE – convex

Type	Dimension [mm]			R	Version		
	Ø	Width	Bore		N° 04 turned & polished, Rz 4 µm	N° 05 ground, Rz 2–3 µm	N° 06 ground & polished, Rz 1 µm
RRE	10	4	4	2	✓	✓	✓
	15	4	4	2	✓	✓	✓
	20	8	6	6	✓	✓	✓
	25	8	6	6	✓	✓	✓

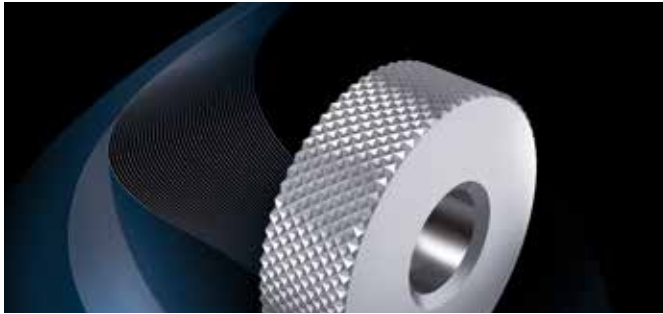

Advantages:

- Longer tool life
- Reduction of tool costs
- Reduction of set-up costs

In addition to the standard variants of powder metal, HSS, and carbide versions are also available on request.

zeus Premium materials

As your supplier of premium tool products we insist on materials that allow machining of hard-to-machine and pressure resistant materials. All knurling wheels in the standard zeus product line are therefore made of power metal.

The material features high hot hardness and compression strength, as well as durability and resistance to wear.

Surface treatment

Suitable treatment based on your individual application can have a positive effect on the life of the knurling wheel. We offer different treatment processes.

TENIFER® salt-bath nitriding heat treatment

Treatment of the knurling wheel in a salt bath based on the TENIFER® process increases the resistance to wear and the fatigue strength. The salt-bath nitrocarburising process achieves a high case hardness.



PVD coatings

Suitable PVD coating of the knurling wheels offers the user additional possibilities for increasing tool life. These variants are available on request. PVD coatings are suitable primarily for cut knurling applications.



Polished knurling wheels

The use of finely polished knurling wheels can be effective for machining of adhesive materials that require optimal chip sliding. This process achieves very smooth surfaces, with a low coefficient of friction. Edge radiusing on the tooth flanks prevents built-up edges from forming and therefore premature tooth breakage.



Technology



Form knurling

Knurl profiles on
DIN 82 workpiece

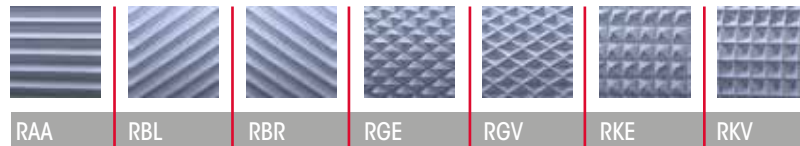

Application:

- Non-cutting forming
- Processing of workpieces suitable for cold forming
- All knurling forms and profiles can be manufactured
- Suitable for face and knurling within a bore
- Knurling up to a shoulder is possible
- Tool can be started at any location on the workpiece

Handling:

- Only minimal preparation of workpiece required
- Very easy handling of tool (short setup times)

Features:

- Material displacement increases the outer diameter of the workpiece
- The surface is compacted
- Form knurling of small diameters is possible only to a limited extent

Cut knurling

Knurl profiles on
DIN 82 workpiece

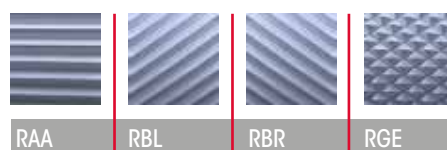

Application:

- Alternative cutting process
- Material removal at axial feed drive
- Machining of thin-walled, soft and hard-to-machine materials is possible
- Only cylindrical workpieces can be machined in axial direction
- Machining of small diameters is possible
- Maximum precision and surface quality, therefore suitable primarily for visible knurling
- A plunge cut is necessary for applying the tool in the middle area of the workpiece
- Knurling up to a shoulder is not possible

Handling:

- Requires precise tool adjustment and fine adjustment
- Requires precise preparation of the workpiece

Features:

- Minimal change in the outer diameter
- Minimal surface compaction
- Lower strain on machine than in form knurling
- Minimum pressure on the workpiece and machine

Wheel geometries

Designation	Abbreviation
Outer diameter	D1
Bore diameter	D2
Width	B1
Pitch	p
Stepped diameter	D3
Stepped diameter	D4
Collar stud bore diameter	D5
Radius	R
Total angle	GW

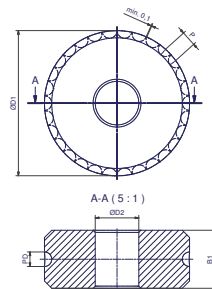

Bead knurl – No. 60

Designation	Abbreviation
Smallest diameter	Da
Average diameter	Dm
Bore depth	T1
Step width	B2
Step width	B3
Knurl width	RB
Knurl width + chamfer	RBF
Pearl diameter	PD

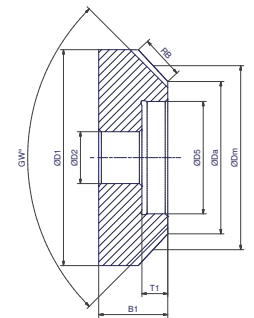

Conical knurling wheels – No. 70

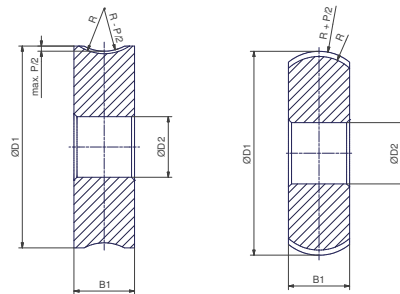

Concave/convex knurling wheels – No. 80

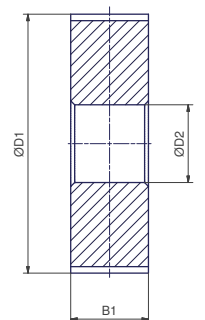

Special knurling wheels – No. 90

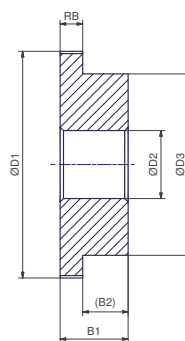

Special knurling wheels – No. 92

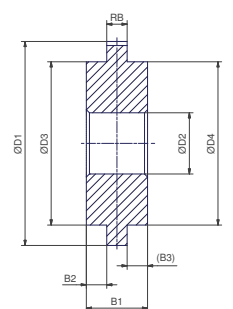

Special knurling wheels – No. 93

Knurl width and chamfer

The knurl width is always defined without the chamfer
 $RB = \text{Knurl Width} / RBF = \text{Knurl Width} + \text{Chamfer}$

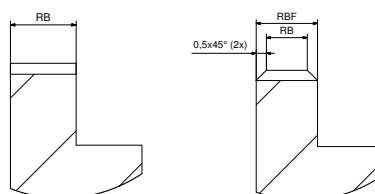

With 10° chamfer – No. 17/18

With 60° chamfer – No. 94/95

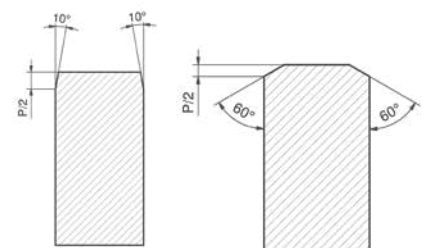

Knurling based on CP (TPI) and DP

■ CP (TPI) = Circular Pitch (Teeth Per Inch)

This standard specifies the number of teeth over a distance of 1 inch (1~25.4 mm). To calculate the pitch, divide 1 inch by the number of teeth. The profile angle is defined as 70° or 90°, depending on the number of teeth per inch.

Conversion example:

Specification CP (TPI) = 20

Pitch (mm) =

1 inch (~25.4 mm) : 20 (number of teeth) = 1.27 mm

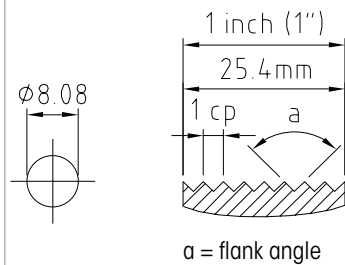

■ DP = Diametral Pitch

As opposed to CP (TPI) this standard specifies the number of teeth on the circumference of a circle with a diameter of 1 inch (1~25.4 mm). To calculate the pitch, divide the circumference of a 1 inch circle by the number of teeth. The profile angle is defined as 80°.

Conversion example:

Specification DP = 64

Pitch (mm) =

1 inch (~25.4) x π (3.14...) : 64 (number of teeth) = 1.25 mm

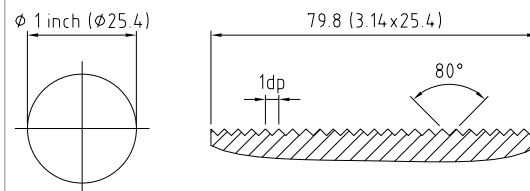

Material displacement – non-cutting forming

Our empirical values for enlargement of the workpiece diameter

Knurling profile acc. to DIN 82: RAA (knurling profile on workpiece)
 Knurling wheels according to DIN 403: AA (knurling profile on knurling wheel)



Pitch [mm]		0.3	0.4	0.5	0.6	0.7	0.8	1.0	1.2	1.5	1.6	2.0
Material	Workpiece Ø [mm]	Enlargement of workpiece diameter in mm										
Free-cutting steel	5	0.08	0.14	0.18	0.22	0.27	0.29	0.35	0.50	–	–	–
	15	0.08	0.14	0.18	0.23	0.30	0.40	0.44	0.50	0.60	0.65	0.70
	25	0.08	0.15	0.23	0.24	0.28	0.35	0.44	0.53	0.62	0.70	0.98
Stainless steel	5	0.10	0.15	0.20	0.25	0.28	0.30	0.42	0.41	–	–	–
	15	0.10	0.15	0.19	0.25	0.30	0.34	0.45	0.51	0.60	–	–
	25	0.10	0.14	0.20	0.26	0.31	0.33	0.43	0.50	0.62	–	–
Brass	5	0.08	0.12	0.18	0.20	0.21	0.22	0.25	0.28	–	–	–
	15	0.10	0.14	0.20	0.26	0.28	0.29	0.35	0.41	0.44	0.48	0.55
	25	0.10	0.15	0.20	0.25	0.28	0.30	0.36	0.43	0.46	0.50	0.53
Aluminium	5	0.09	0.15	0.19	0.23	0.28	0.30	0.41	0.40	–	–	–
	15	0.10	0.15	0.19	0.26	0.29	0.33	0.45	0.51	0.57	0.65	–
	25	0.09	0.15	0.19	0.26	0.29	0.32	0.45	0.52	0.59	0.65	0.75

Knurling profile acc. to DIN 82: RBL30°/RBR30° (knurling profile on workpiece)
 Knurling wheels according to DIN 403: BR30°/BL30° (knurling profile on knurling wheel)



Pitch [mm]		0.3	0.4	0.5	0.6	0.7	0.8	1.0	1.2	1.5	1.6	2.0
Material	Workpiece Ø [mm]	Enlargement of workpiece diameter in mm										
Free-cutting steel	5	0.11	0.15	0.20	0.24	0.28	0.34	0.45	0.55	–	–	–
	15	0.11	0.15	0.22	0.26	0.30	0.35	0.45	0.52	0.67	0.73	0.85
	25	0.11	0.14	0.23	0.25	0.28	0.36	0.45	0.56	0.70	0.72	0.90
Stainless steel	5	0.09	0.14	0.19	0.25	0.31	0.34	0.45	0.52	–	–	–
	15	0.12	0.20	0.23	0.31	0.35	0.40	0.51	0.62	0.66	0.73	0.97
	25	0.12	0.18	0.24	0.27	0.37	0.39	0.49	0.59	0.80	0.84	0.96
Brass	5	0.10	0.14	0.20	0.23	0.24	0.28	0.33	0.37	–	–	–
	15	0.10	0.15	0.21	0.23	0.24	0.31	0.41	0.47	0.53	0.55	0.63
	25	0.11	0.15	0.22	0.22	0.25	0.30	0.40	0.45	0.55	0.61	0.68
Aluminium	5	0.12	0.14	0.21	0.24	0.29	0.34	0.41	0.51	–	–	–
	15	0.12	0.18	0.23	0.26	0.36	0.40	0.50	0.56	0.56	0.61	0.75
	25	0.12	0.18	0.25	0.28	0.37	0.39	0.50	0.58	0.77	0.82	0.96

Knurling profile acc. to DIN 82: RGE30° (knurling profile on workpiece)
 Knurling wheels according to DIN 403: BR30°+BL30° (knurling profile on knurling wheel)



Pitch [mm]		0.3	0.4	0.5	0.6	0.7	0.8	1.0	1.2	1.5	1.6	2.0
Material	Workpiece Ø [mm]	Enlargement of workpiece diameter in mm										
Free-cutting steel	5	0.12	0.16	0.20	0.25	0.33	0.41	0.55	0.65	–	–	–
	15	0.13	0.22	0.30	0.32	0.35	0.41	0.52	0.62	0.67	0.81	0.95
	25	0.12	0.18	0.28	0.32	0.35	0.38	0.55	0.67	0.77	0.87	0.98
Stainless steel	5	0.11	0.20	0.25	0.30	0.36	0.39	0.55	0.55	–	–	–
	15	0.10	0.14	0.21	0.24	0.29	0.34	0.43	0.53	0.66	0.72	0.88
	25	0.11	0.13	0.20	0.25	0.28	0.32	0.44	0.52	0.67	0.70	0.83
Brass	5	0.12	0.13	0.16	0.20	0.24	0.28	0.32	0.38	–	–	–
	15	0.12	0.16	0.18	0.24	0.28	0.30	0.39	0.40	0.48	0.52	0.63
	25	0.12	0.17	0.22	0.23	0.27	0.30	0.38	0.41	0.48	0.50	0.63
Aluminium	5	0.10	0.15	0.21	0.25	0.33	0.36	0.50	0.57	–	–	–
	15	0.11	0.14	0.20	0.25	0.28	0.33	0.43	0.54	0.67	0.71	0.89
	25	0.11	0.15	0.22	0.25	0.29	0.34	0.44	0.53	0.68	0.69	0.88

!

Important notice:

This information represents empirical values. Deviations are possible.

Reference values for cutting speed and feed rate



Form knurling – non-cutting process

Material	Workpiece Ø [mm]	Knurling wheel Ø [mm]	Vc [m/min]		f [mm/U]					
					Radial		Axial			
			from	to	from	to	Pitch [mm]			
						>0.3 < 0.5	>0.5 < 1.0	>1.0 < 1.5	>1.5 < 2.0	
Free-cutting steel	< 10	10/15	20	50	0.04	0.08	0.14	0.09	0.06	0.05
	10 - 40	15/20	25	55	0.05	0.10	0.20	0.13	0.10	0.07
	40 - 100	20/25	30	60	0.05	0.10	0.25	0.18	0.12	0.08
	100 - 250	20/25	30	60	0.05	0.10	0.30	0.20	0.13	0.09
	> 250	25	30	60	0.05	0.10	0.32	0.21	0.14	0.10
Stainless steel	< 10	10/15	15	40	0.04	0.08	0.12	0.08	0.05	0.04
	10 - 40	15/20	20	50	0.05	0.10	0.17	0.11	0.09	0.06
	40 - 100	20/25	25	50	0.05	0.10	0.21	0.15	0.10	0.07
	100 - 250	20/25	25	50	0.05	0.10	0.26	0.17	0.11	0.08
	> 250	25	25	50	0.05	0.10	0.27	0.18	0.12	0.09
Brass	< 10	10/15	30	75	0.04	0.08	0.15	0.09	0.06	0.05
	10 - 40	15/20	40	85	0.05	0.10	0.21	0.14	0.11	0.07
	40 - 100	20/25	45	90	0.05	0.10	0.26	0.19	0.13	0.08
	100 - 250	20/25	45	90	0.05	0.10	0.32	0.21	0.14	0.09
	> 250	25	45	90	0.05	0.10	0.34	0.22	0.15	0.11
Aluminium	< 10	10/15	25	60	0.04	0.08	0.18	0.11	0.08	0.06
	10 - 40	15/20	30	65	0.05	0.10	0.25	0.16	0.13	0.09
	40 - 100	20/25	35	70	0.05	0.10	0.31	0.23	0.15	0.10
	100 - 250	20/25	35	70	0.05	0.10	0.38	0.25	0.16	0.11
	> 250	25	35	70	0.05	0.10	0.40	0.26	0.18	0.13



Important notice:

This information represents reference values.

The optimal values are to be found in the application. Ensure effective cooling/lubrication to prevent chips from being rolled into the profile and to prolong the life of the knurling wheels.

Cut knurling – cutting process

Material	Workpiece Ø [mm]	Knurling wheel Ø [mm]	Vc [m/min]		f [mm/U]					
					Radial		Axial			
			from	to	from	to	Pitch [mm]			
						>0.3 < 0.5	>0.5 < 1.0	>1.0 < 1.5	>1.5 < 2.0	
Free-cutting steel	< 10	10/15	40	70	0.04	0.08	0.20	0.13	0.08	0.07
	10 - 40	15/25	50	90	0.05	0.10	0.28	0.18	0.14	0.10
	40 - 100	25/32/42	65	110	0.05	0.10	0.35	0.25	0.17	0.11
	100 - 250	25/32/42	65	110	0.05	0.10	0.42	0.28	0.18	0.13
	> 250	32/42	80	100	0.05	0.10	0.45	0.29	0.20	0.14
Stainless steel	< 10	10/15	22	40	0.04	0.08	0.14	0.09	0.06	0.05
	10 - 40	15/25	30	50	0.05	0.10	0.20	0.13	0.10	0.07
	40 - 100	25/32/42	35	60	0.05	0.10	0.25	0.18	0.12	0.08
	100 - 250	25/32/42	35	60	0.05	0.10	0.29	0.20	0.13	0.09
	> 250	32/42	45	55	0.05	0.10	0.31	0.21	0.14	0.10
Brass	< 10	10/15	55	100	0.04	0.08	0.22	0.14	0.09	0.08
	10 - 40	15/25	70	125	0.05	0.10	0.31	0.20	0.15	0.11
	40 - 100	25/32/42	90	155	0.05	0.10	0.39	0.28	0.18	0.12
	100 - 250	25/32/42	90	155	0.05	0.10	0.46	0.31	0.20	0.14
	> 250	32/42	115	140	0.05	0.10	0.49	0.32	0.22	0.15
Aluminium	< 10	10/15	70	120	0.04	0.08	0.12	0.08	0.05	0.04
	10 - 40	15/25	80	150	0.05	0.10	0.17	0.11	0.08	0.06
	40 - 100	25/32/42	110	160	0.05	0.10	0.21	0.15	0.10	0.07
	100 - 250	25/32/42	110	160	0.05	0.10	0.25	0.17	0.11	0.08
	> 250	32/42	130	150	0.05	0.10	0.27	0.18	0.12	0.08

Optimization of knurling

The pitch corresponds to the workpiece circumference

In many cases the user does not notice the relationship between the pitch and the workpiece circumference, since the pitch already corresponds to the workpiece circumference. The knurling wheel can compensate the distortion of the pitch to produce good knurling (see Figure 1).

The pitch does not optimally correspond to the workpiece circumference

The more unfavourable the pitch corresponds to the workpiece circumference, the more the knurling wheel has to compensate. This results in knurling of poor quality and reduces the tool life.

Effects on the knurling quality:

■ Form knurling:

The less favourable forming process (unnecessary strain on the material) results in a rough surface and reduced tool life. The sub-optimal penetration process causes material abrasion, which is formed into the knurling profile (indistinct profile flanks). This results in distortions of the knurling profile, which are evident in flattening of the profile and rounding of the tooth crest and tooth gullet (see Figure 2).

■ Cut knurling:

The sub-optimal penetration process of the knurling wheel results in indistinct profile flanks (shadowing). This results in distortions of the knurling profile, which are evident in flattening of the knurling profile and rounding of the tooth crest and tooth gullet (see Figure 2).

The pitch does not correspond to the workpiece circumference

This is an extreme case. The knurling wheel cannot compensate the unfavourable relationship between the pitch and the workpiece circumference, or the profile is heavily distorted.

In the worst case this can result in "double knurling". The knurling wheel then no longer engages in the knurling profile after one workpiece rotation, but instead engages between the profile.

This is evident in the finer pitch of the knurling (see Figure 3).

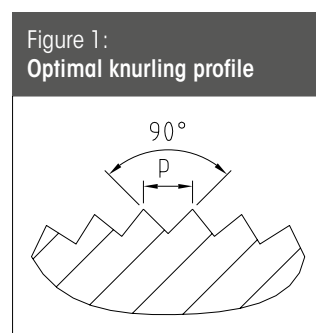

p = pitch

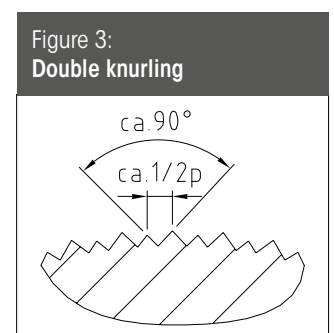
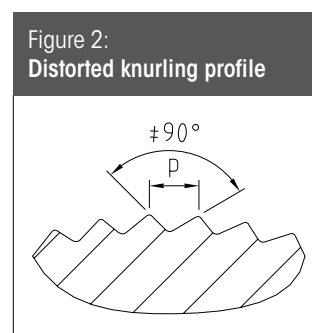

Optimization of knurling

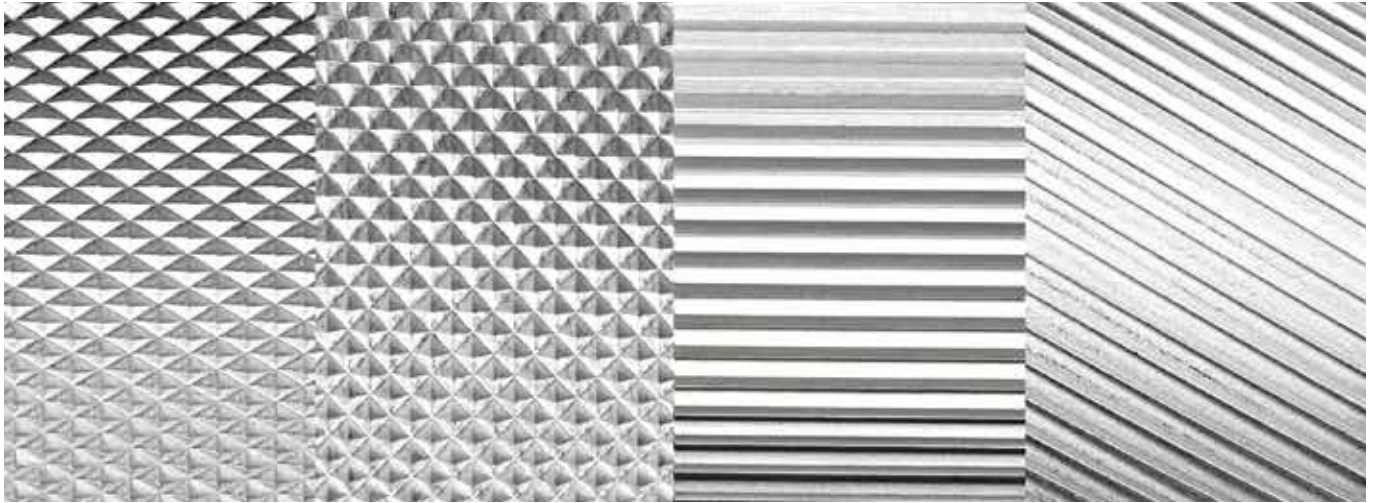

The knurling quality and the tool life can be improved substantially by optimising the knurling by changing the rough-turn diameter and/or the pitch.

The following procedure ensures systematic optimisation:

- **Correction of the rough-turn diameter until optimal knurling is achieved.**

Note:

Changing the rough-turn diameter by only a few hundredths of a millimetre has a substantial effect on the circumference {factor π (x 3.14...)} and can improve the knurling quality significantly.

If a correction is not possible (tolerances cannot be maintained; workpiece diameter should not be turned), then:

- **Check whether the pitch can be changed.**

If it is not possible to change the pitch, it is necessary to manufacture a special knurling wheel with optimised pitch (defined number of teeth/outer diameter of knurling wheel).

Consultation is provided by the Hommel+Keller application engineer on the basis of a workpiece drawing and information about the machine.

The calculation of the optimal pitch is conducted on the basis of approximate formulas. Due to influencing factors (such as differences in materials) further optimisation may be necessary.

Summary:

Customer requirements:

- Clear, distinct knurling profile
- Fully formed teeth
- No double knurling/no incomplete knurling

Solutions:

1) Optimisation measures by user:

- Correction of the rough-turn diameter
- Change of the pitch

2) Optimisation measures by Hommel+Keller:

- Optimisation by manufacturing a special knurling wheel:
- Calculation of the number of teeth allows development of a knurling wheel that is specially designed for the application based on the optimal relationship between the diameter and the number of teeth.

Influencing factors

Clearance dimensions/plunge cut for cut knurling

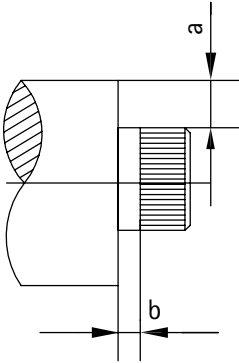

■ Clearance dimension for cut knurling – workpiece collar

Due to the design-related inclination (30°) of the knurling head and the overhang of the cover plate, knurling up to a collar is not possible with a cut knurling tool.

Dimension a corresponds to the increase in the step (mm).
Dimension b corresponds to the minimum clearance for the respective knurling wheel (Ø specified in mm).

Dimension "a" [mm]	b 10 x 3 x 6 mm	b 15 x 4 x 8 mm	b 25 x 6 x 8 mm	b 42 x 13 x 16 mm
1	1.3	1.5	2	3
3	2.7	4.2	3.2	5
5	3	4.9	4.5	7
7	3	5.2	5.5	9
10	3	5.2	6.7	12
12	3	5.2	7	12

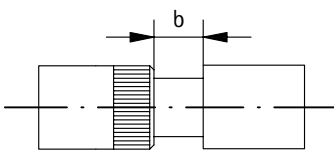

■ Minimum width of the plunge cut – cut knurling

If knurling is to be applied in the middle of the workpiece, a "knurling undercut" is needed (the knurling wheel requires a chamfer for centring).
Depth of the plunge cut: at least 1/2 pitch + 0.3 mm.

Dimension Knurling wheels [mm]	10 x 3 x 6 mm	15 x 4 x 8 mm	25 x 6 x 8 mm	42 x 13 x 16 mm
Minimum width of plunge (b)	3 mm	4 mm	6.5 mm	14 mm

Influencing factors



Factors affecting quality and process reliability during knurling

Numerous factors must be taken into account and optimised in order to manufacture a high-quality and functional knurling profile.

The factors listed below are crucial for process reliability, quality, precision and surface quality and should be taken into account in order to optimise the application.

Tool properties	Quality and specification of the knurling wheel	Knurl width			
		Knurling wheel with chamfer			
		Material properties	Base material for the knurling wheel		
			Hardness of the knurling wheel		
		Reworking	PVD coating		
			TENIFER®		
		Precision	Run-out accuracy		
	Concentricity				
	Type of tool holder used	Type of knurling process	Form knurling	Plunge knurling	
				Feed knurling	
			Plunge/feed knurling		
		Cut knurling			
Quality and condition of the axle pin/bearing bush					
Stability/freedom from vibration					
Precision					
Machine properties	Precision				
	Stability/freedom from vibration				
Properties of the material to be machined	Hardness				
	Strength				
	Cutting values	Feed rate			
	Plunge depth				
	Cooling/lubrication	Cutting speed			
	Clearance angle				
	Quality of teeth	Rough-turn diameter			
		Pitch/number of teeth			
Material distortion					



zeus – a brand name of
Hommel+Keller



PRÄZISIONSWERKZEUGE

Hommel+Keller
Präzisionswerkzeuge GmbH
78554 Aldingen · Germany
Tel. +49 7424 9705-0
info@zeus-tooling.de
www.zeus-tooling.de