



Sauna Linear LED

Installation Instruction

Instructions d'installation

1816012

1816013

1

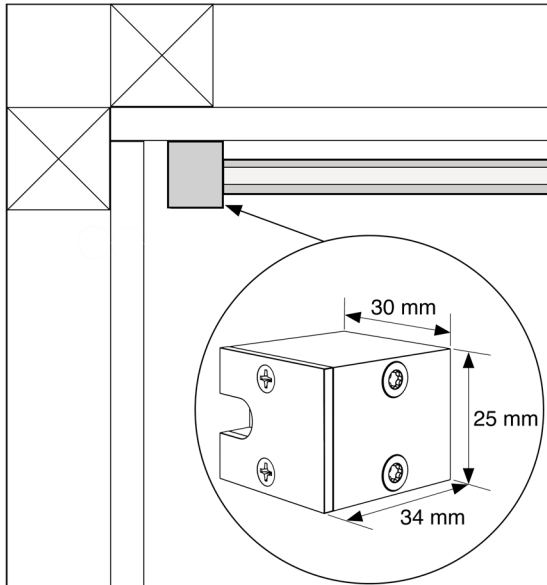

2

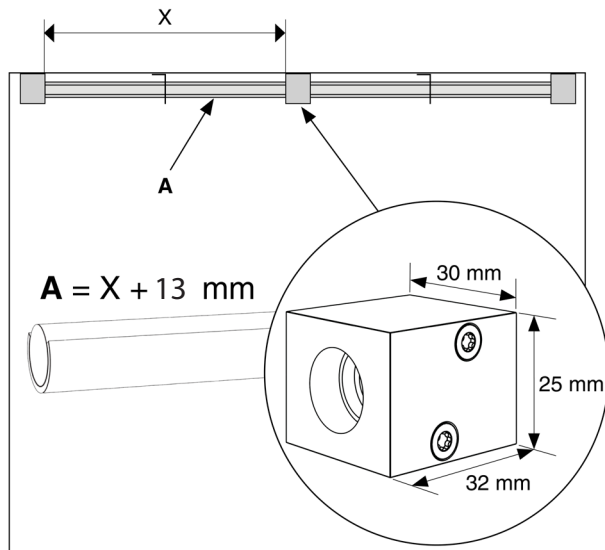

3

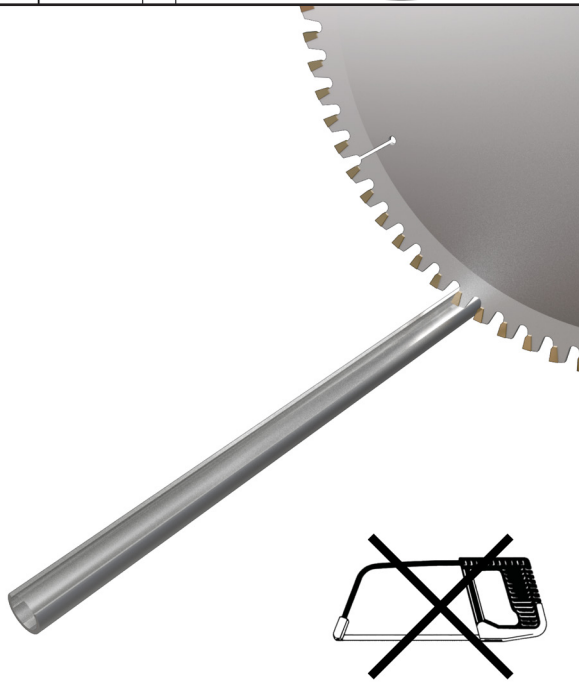

4

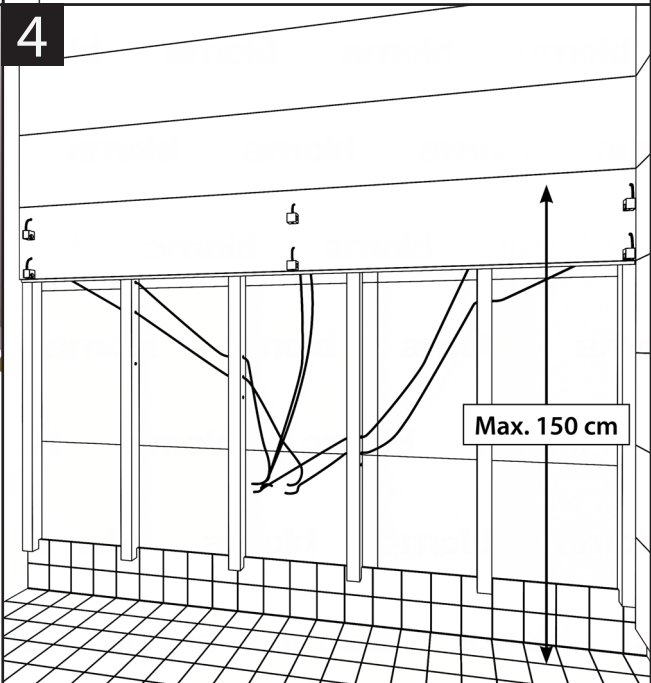

5

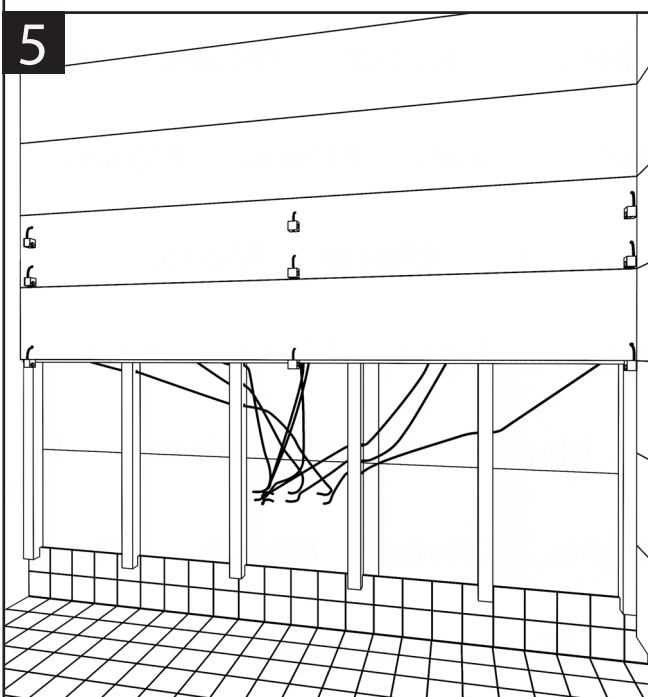

6

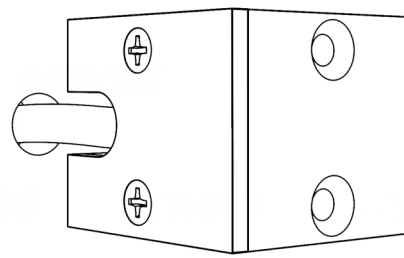

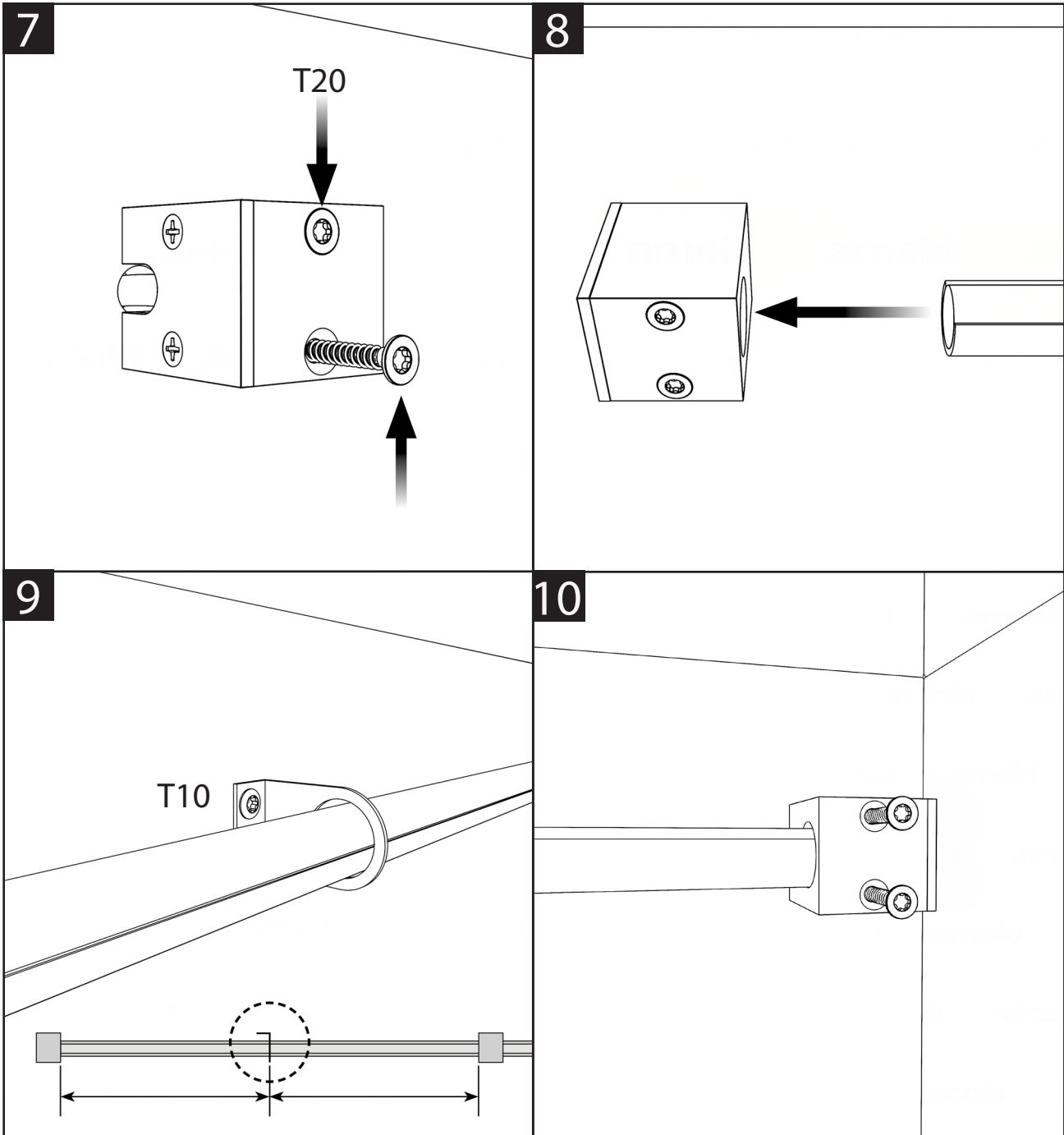

Sauna Linear 3M (max length 10' 08" = 3072 mm)

IP55

- Include:
1. 2 pc LED heads incl. cable 100 in. (2,5 m)
 2. 1 pc middle LED head incl. cable 100 in. (2,5 m)
 3. 2 pc optical rods L = 4' 11" (1500 mm)
 4. 2 pc supportt brackets + 4 pc screws (for the rods)
 5. 6 pc screws (for the LED heads)
 6. 1 pc mounting box IP66
 7. 4 pc screws (for the mounting box)
 8. 4 pc PG11 cable gland
 9. 1 pc PG9 cable gland
 10. 1 pc power supply
 11. 1 pc serial connection module
 12. 6 pc short circuit jumpers

Sauna Linear 6M + spot (max length 2 x 10' 08" = 2 x 3072 mm)

IP55

1. 4 pc LED heads incl. cable 100 in. (2,5 m)
2. 2 pc middle LED heads incl. cable 100 in. (2,5 m)
3. 4 pc optical rods L = 4' 11" (1500 mm)
4. 4 pc supportt brackets + 8 pc screws(for the rods)
5. 12 pc screws (for the LED heads)
6. 1 pc mounting box IP66
7. 4 pc screws (for the mounting box)
8. 7 pc PG11 cable glands
9. 1 pc PG9 cable gland
10. 1 pc power supply
11. 1 pc serial connection module
12. 6 pc short circuit jumpers
13. 1 pc stove lens fibre 16' 4" (fibre, lens and LED) (5000 mm)

In case the manufacturer´s installation instructions are not followed, and if any other components than those listed in the instructions are used, the manufacturer´s guarantee and liability become null and void.

You will need the following tools

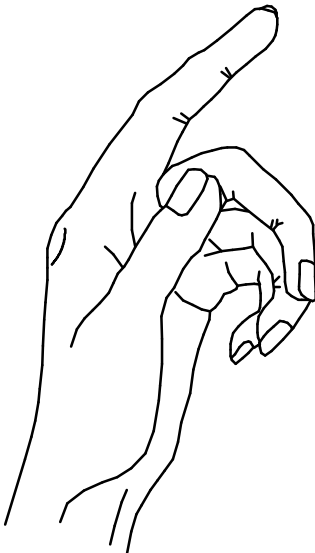

- Drill machine
- Torx screwdriver T20 and T10
- Slotted screwdriver
- Drill bits 5/8 and 3/4 in. (16 mm and 19 mm)
- Fixed tool 3/4 and 7/8 in. (19 mm and 22 mm)
- Voltage meter
- Miter saw
- Phillips 3.0 screwdriver
- Flathead 2.0 screwdriver

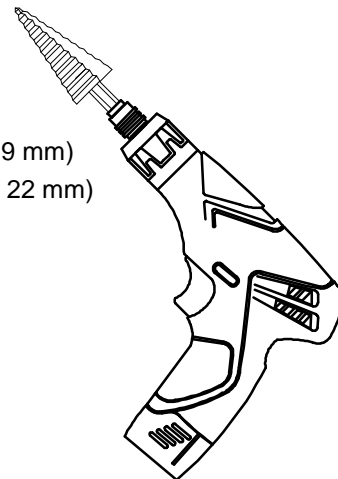

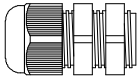

PG9 for the stove lens fibre.
Need a 5/8 in. hole (16 mm).

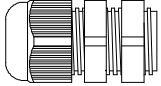

PG11 for the Sauna Linear cable and power supply cord
Need a 3/4 in. hole (19 mm).

Sauna Linear 3M

4 pc 3/4 in. (19 mm) holes

1 pc 5/8 in. (16 mm) hole

PG9
Need to be installed if
you use a stove lens fibre.

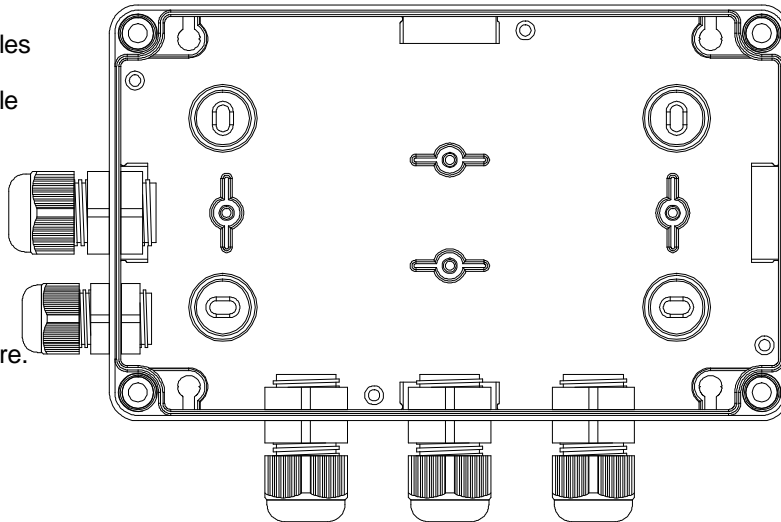

Sauna Linear 6M + spot

7 pc 3/4 in. (19 mm) holes

1 pc 5/8 in. (16 mm) hole

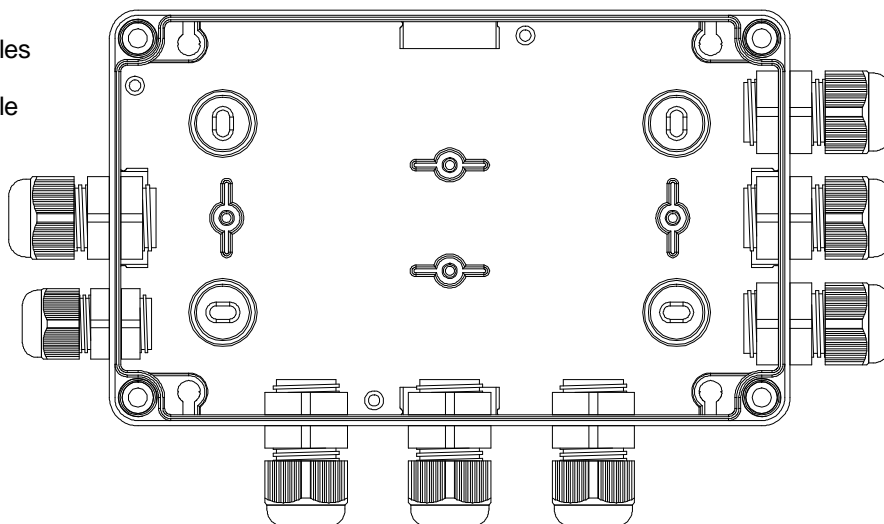

Mounting box installation

Installation on the wall



4 pc screws



4 pc plastic caps

Finishing the installation with plastic caps



4 pc

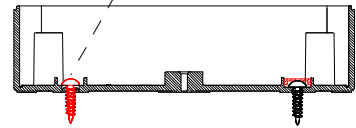

Correct installation position

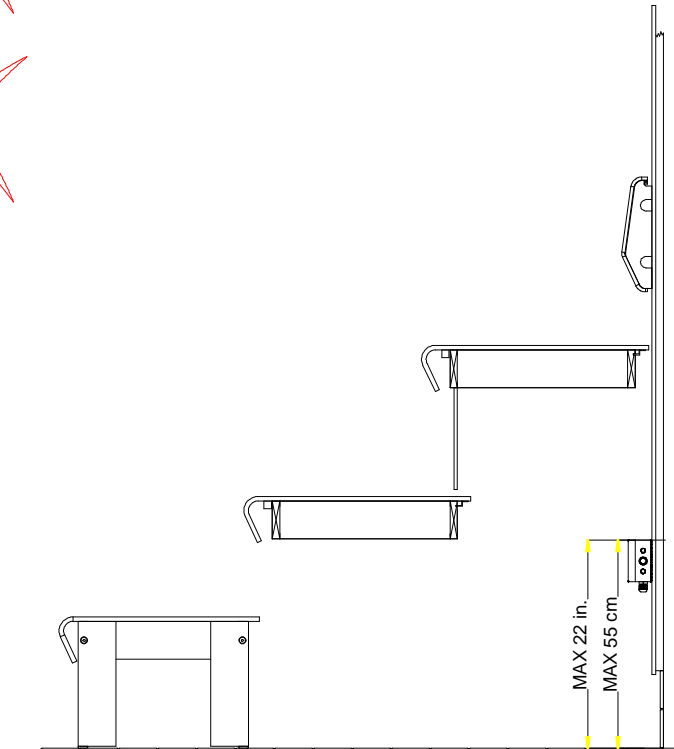
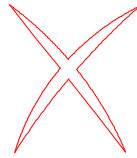
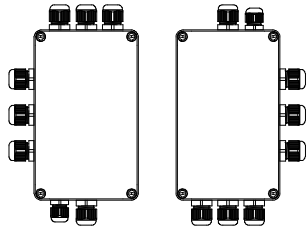
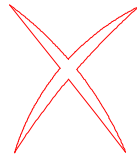
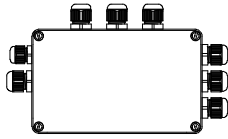
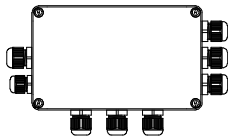

When installing inside the sauna, the maximum installation height for the mounting box.

Sauna Linear 3M

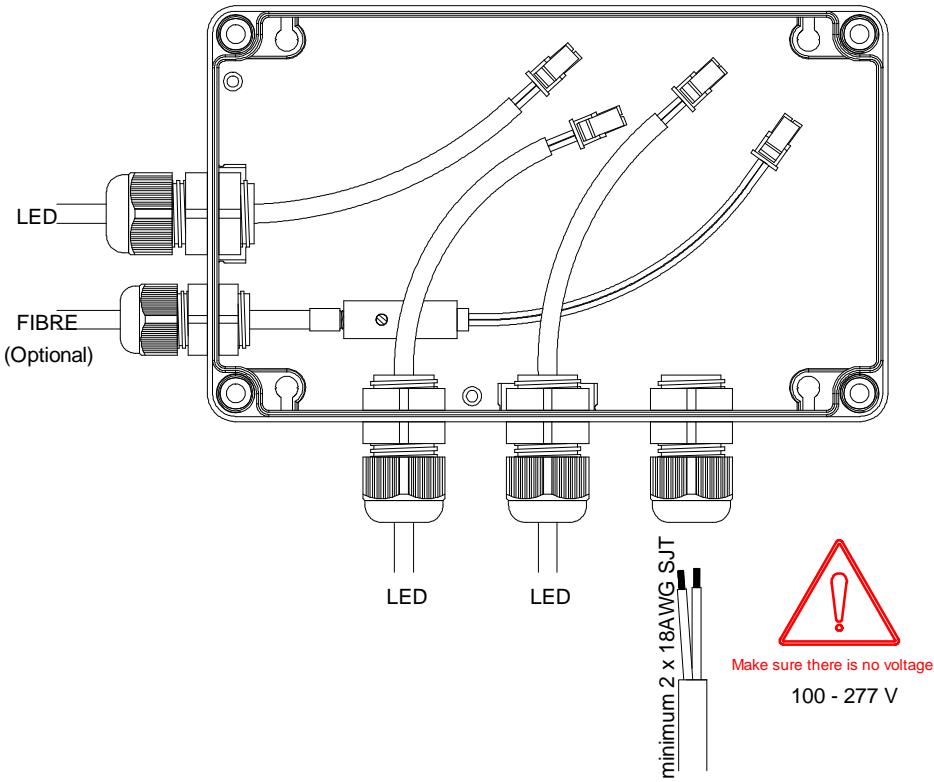

Serial connection module has to be full. No empty places!
After connections tighten all cable glands



Do not change this setting!
350 mA is the maximum current.
A higher current will damage the LEDs

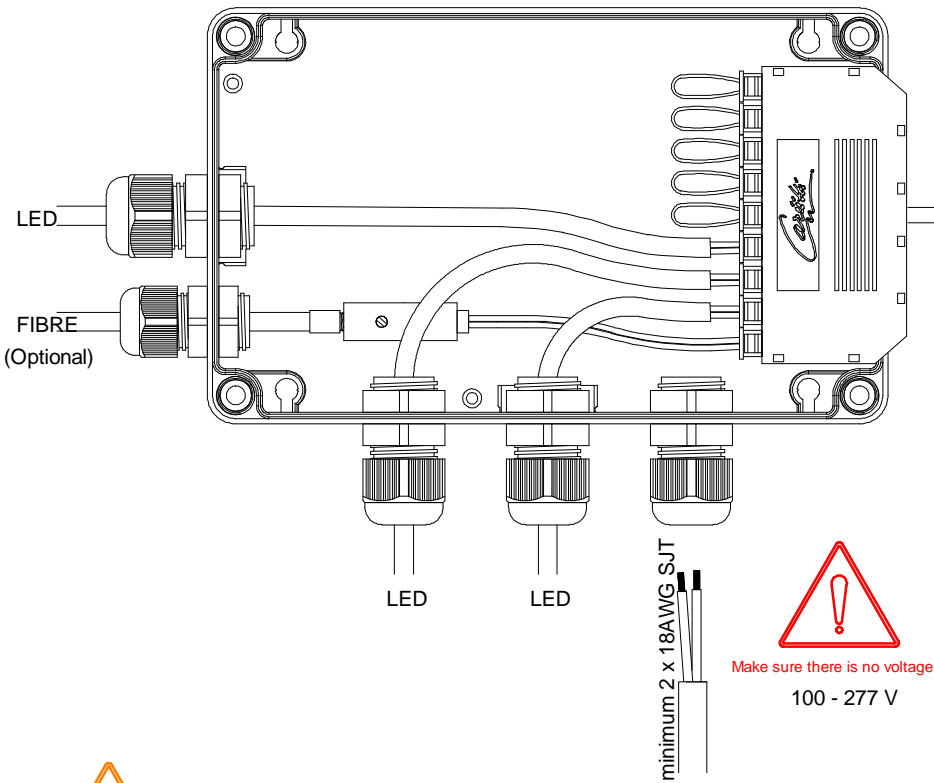

Never connect or disconnect LEDs when voltage is applied. Causes the LED to fail.

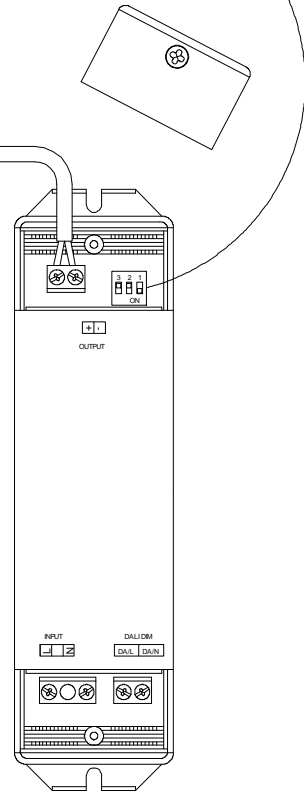

Sauna Linear 6M + spot

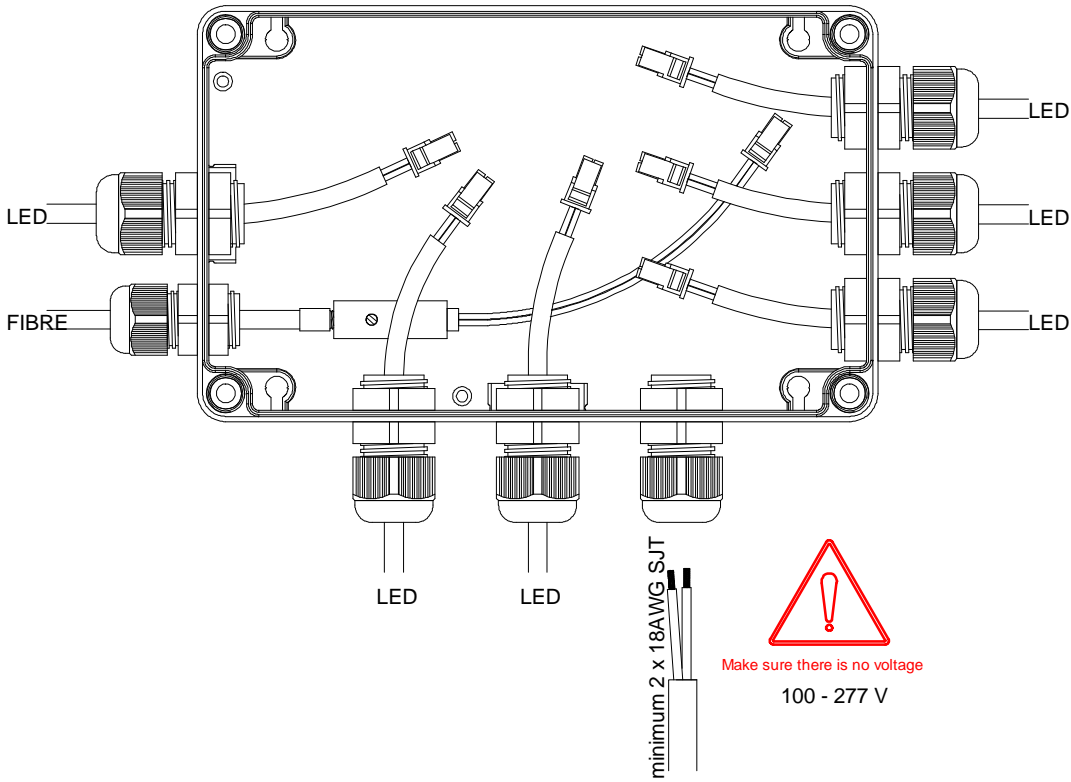

Serial connection module has to be full. No empty places!
After connections tighten all cable glands



Do not change this setting!
350 mA is the maximum current.
A higher current will damage the LEDs

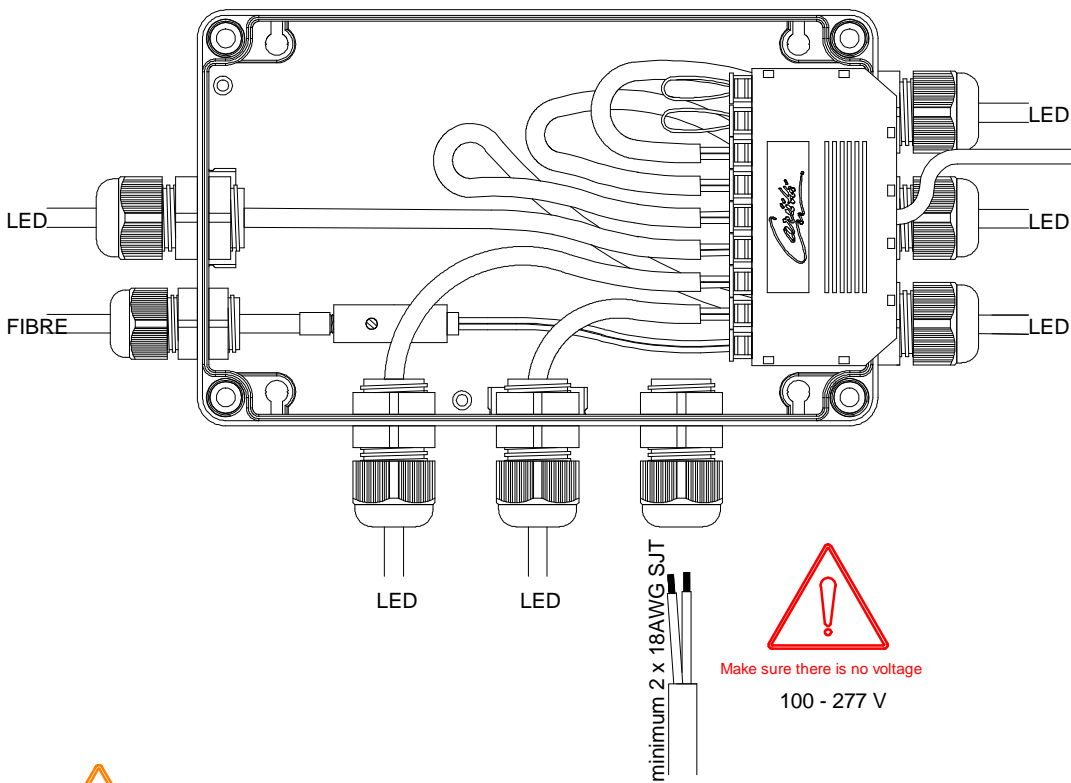

Never connect or disconnect LEDs when voltage is applied. Causes the LED to fail.

INPUT 100 - 277 V



Make sure there is no voltage

100 - 277 V

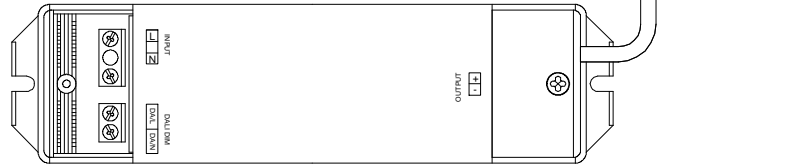
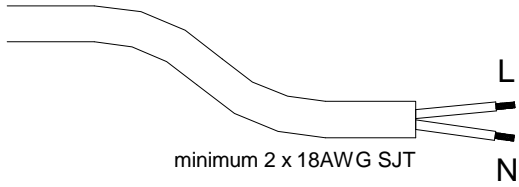

Make sure there is no voltage

100 - 277 V

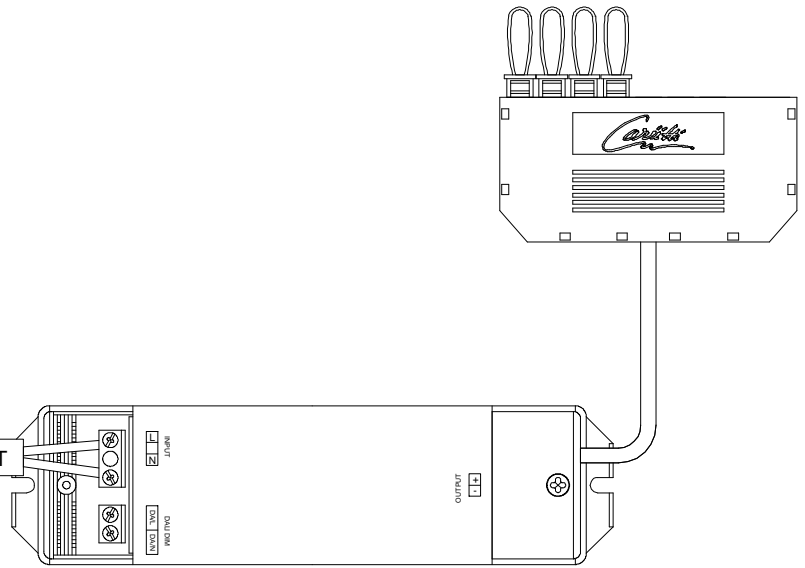
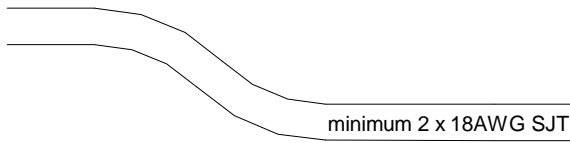

Make sure there is no voltage

100 - 277 V

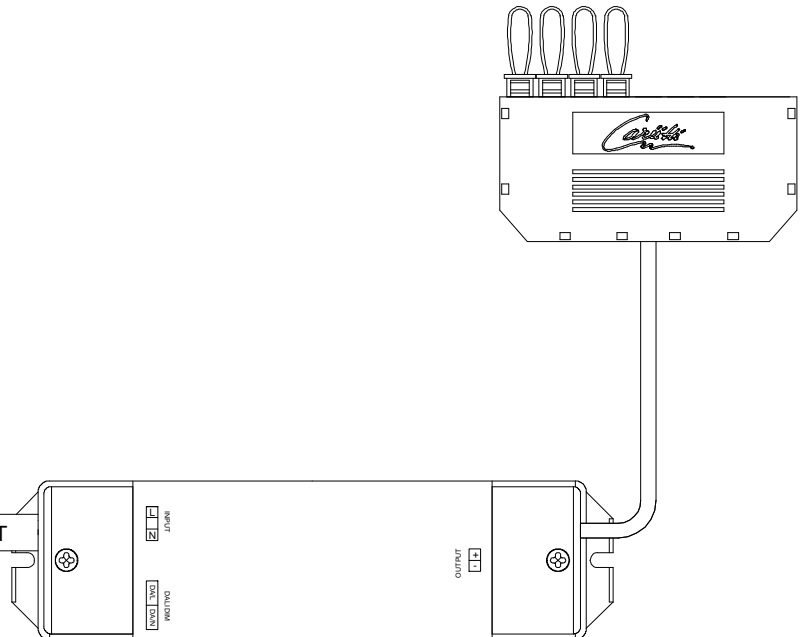
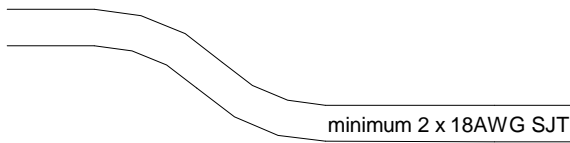

Sauna Linear 3M (longueur max 10' 08" = 3072 mm)

IP55

- Inclut :
1. 2 têtes de diodes avec câble 100 in. (2,5 m)
 2. 1 tête de diodes centrale avec câble 100 in. (2,5 m)
 3. 2 tiges optiques L = 4' 11" (1500 mm)
 4. 2 accroches pour tiges optiques + 4 vis
 5. 6 vis (pour les têtes de diodes)
 6. 1 boîtier de montage IP66
 7. 4 vis pour le boîtier de montage
 8. 4 presse-étoupes PG11
 9. 1 presse-étoupe PG9
 10. 1 alimentation
 11. 1 module de connexion série
 12. 6 ponts de court-circuit

Sauna Linear 6M + spot (longueur max 2 x 10' 08" = 2 x 3072 mm)

IP55

1. 4 têtes de diodes avec câble 100 in. (2,5 m)
2. 2 têtes de diodes centrales avec câble 100 in. (2,5 m)
3. 4 tiges optiques L = 4' 11" (1500 mm)
4. 4 accroches pour tiges optiques + 8 vis
5. 12 vis (pour les têtes de diodes)
6. 1 boîtier de montage IP66
7. 4 vis pour le boîtier de montage
8. 7 presse-étoupes PG11
9. 1 presse-étoupe PG9
10. 1 alimentation
11. 1 module de connexion série
12. 6 ponts de court-circuit
13. 1 fibre pour lentille de poêle 16' 4" (fibre, lentille et diode) (5000 mm)

En cas de non-respect des instructions d'installation du fabricant et si d'autres composants que ceux énumérés dans les instructions sont utilisés, la garantie et la responsabilité du fabricant deviendront nulles et non avenues.

Vous aurez besoin des outils suivants :

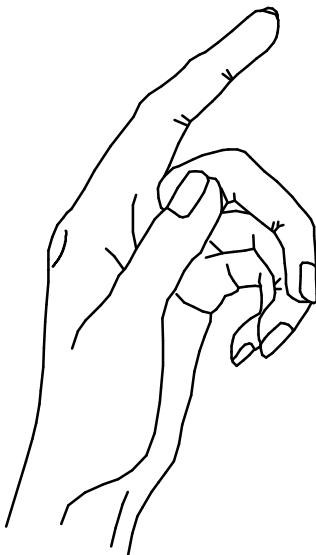

- Perceuse
- Tournevis Torx T20 et T10
- Tournevis plat
- Forets 5/8 et 3/4 po. (16 mm et 19 mm)
- Outil fixe 3/4 et 7/8 po. (19 mm et 22 mm)
- Voltmètre
- Scie à onglets
- Tournevis Phillips 3.0
- Tournevis plat 2.0

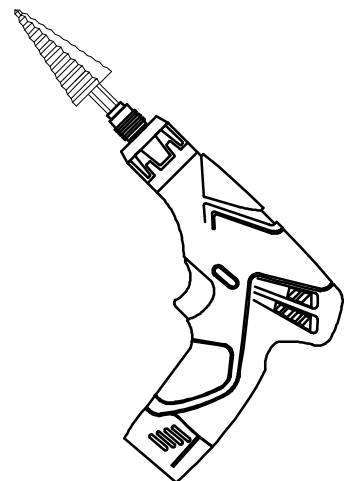

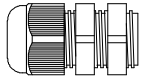

PG9 pour la fibre pour lentille de poêle.

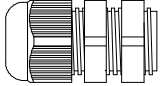

PG11 pour le câble Sauna Linear et le câble d'alimentation
Un trou de 3/4 in. (19 mm) et nécessaire.

Sauna Linear 3M

4 trous de 3/4 po. (19 mm)

1 trou de 5/8 po. (16 mm)

PG9

Doit être installé,
si vous utilisez une fibre
pour lentille de poêle.

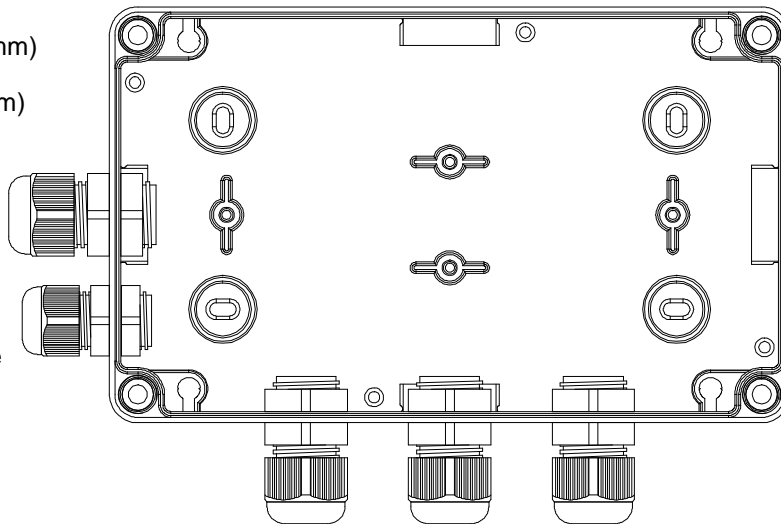

Sauna Linear 6M + spot

7 trous de 3/4 po. (19 mm)

1 trou de 5/8 po. (16 mm)

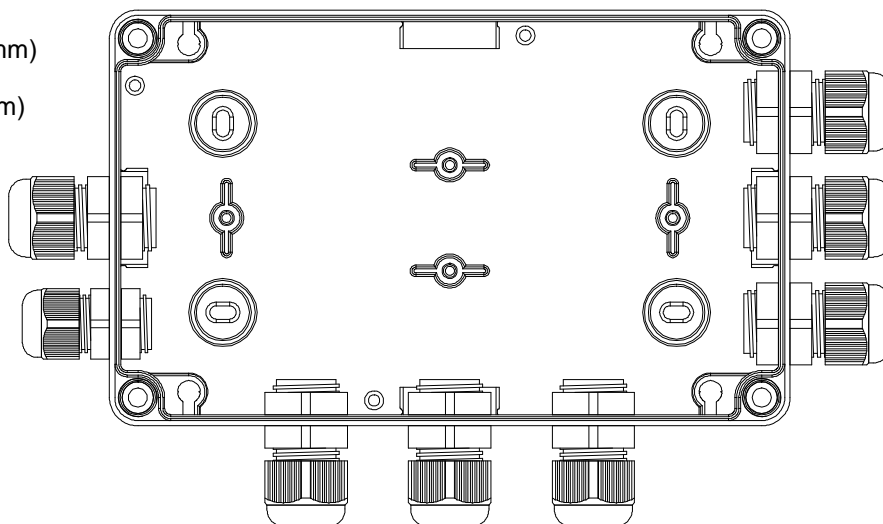

Installation du boîtier de montage

Installation murale



4 vis



4 bouchons en plastique
Montage terminé avec des bouchons en plastique



4 pc

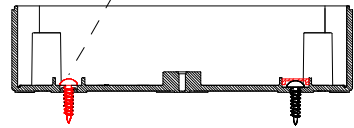

Position de montage correcte

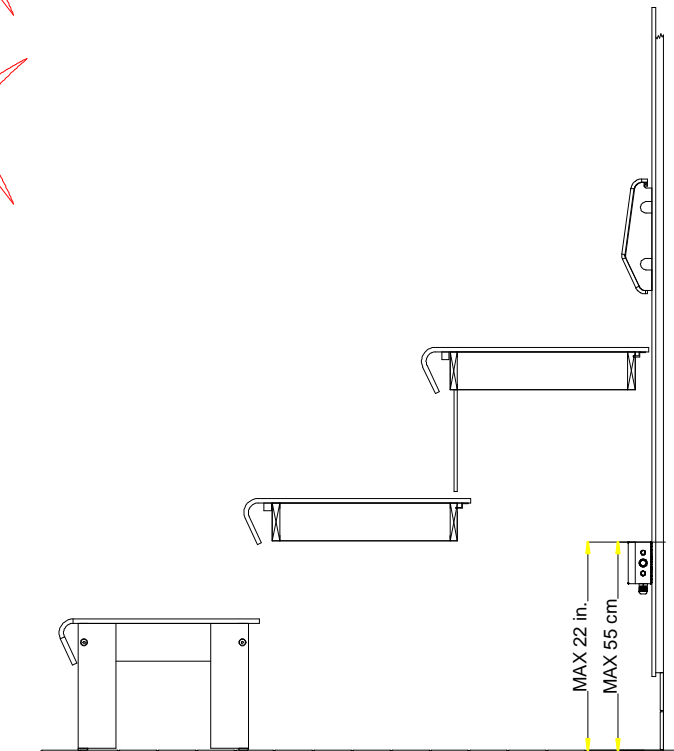
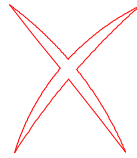
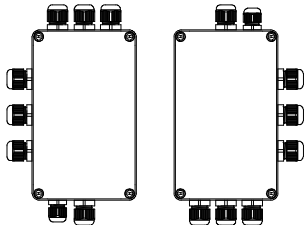
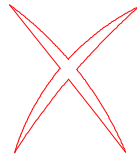
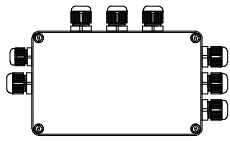
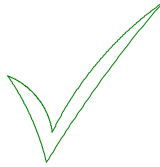
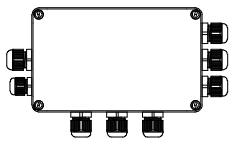

Lors d'une installation à l'intérieur du sauna, hauteur maximale d'installation pour la boîte de montage.

Sauna Linear 3M

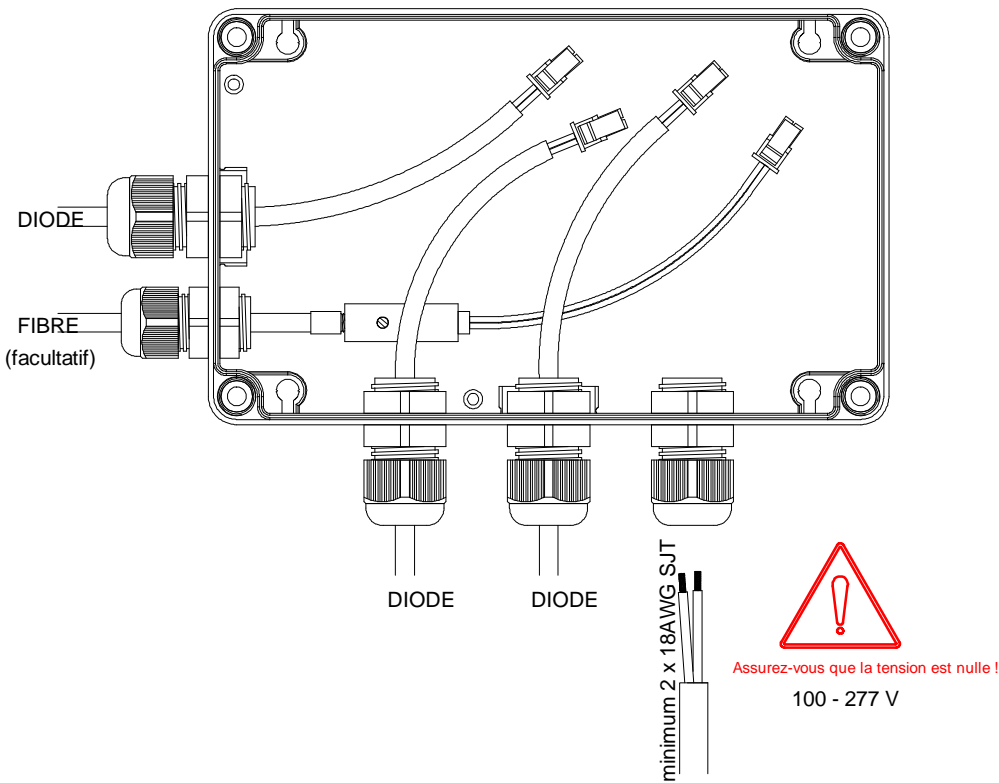

Le module de connexion série doit être complet. Pas d'emplacement vide !

Une fois les branchements terminés, serrez tous les presse-étoupes



Ne modifiez pas ce paramètre !
350 mA est le courant maximum.
Un courant supérieur endommagera les diodes

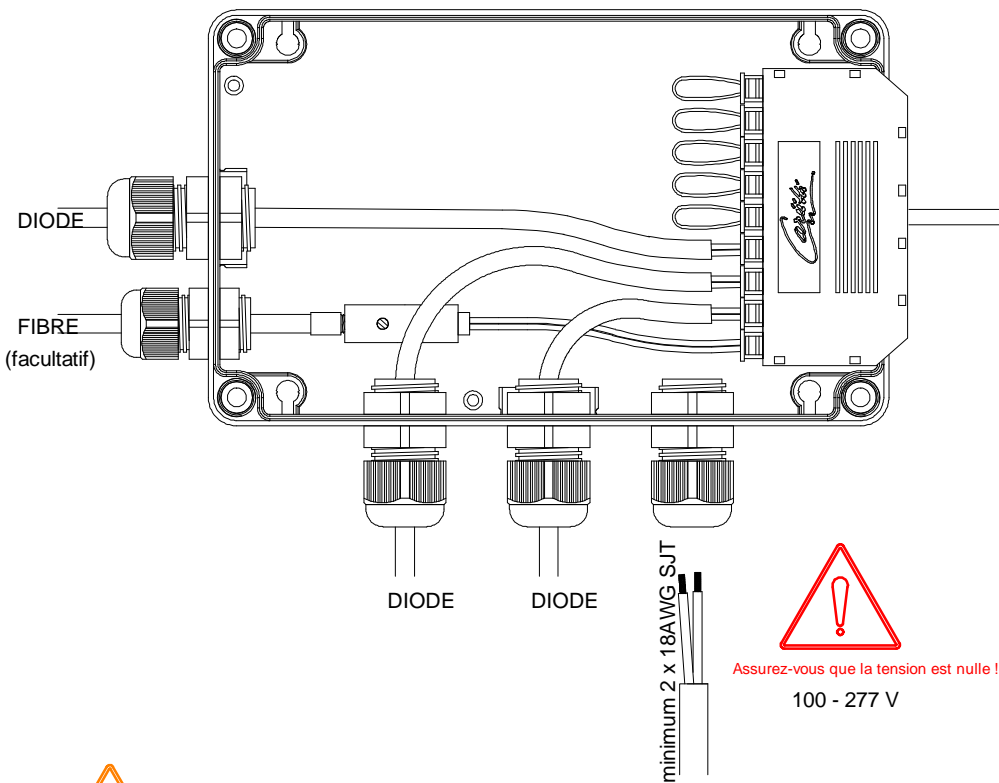

Ne jamais brancher ou débrancher les diodes lorsqu'une tension est appliquée. Provoque la défaillance des diodes.

Sauna Linear 6M + spot

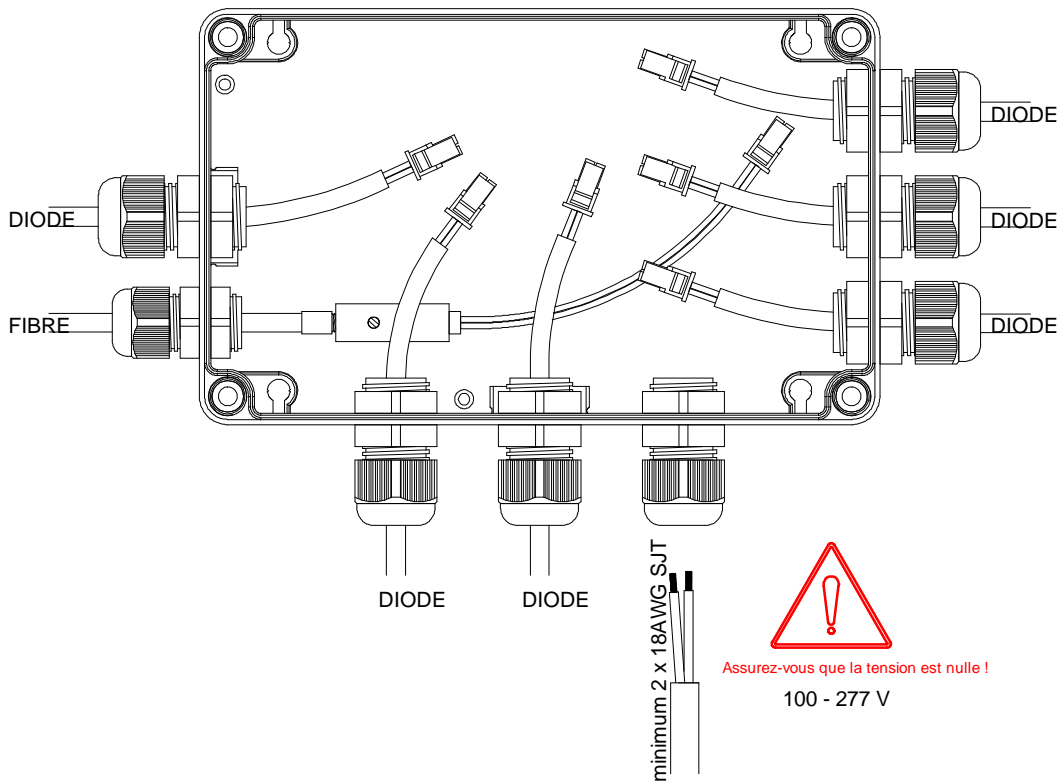

Le module de connexion série doit être complet. Pas d'emplacement vide !

Une fois les branchements terminés, serrez tous les presse-étoupes



Ne modifiez pas ce paramètre !
350 mA est le courant maximum.
Un courant supérieur endommagera les diodes

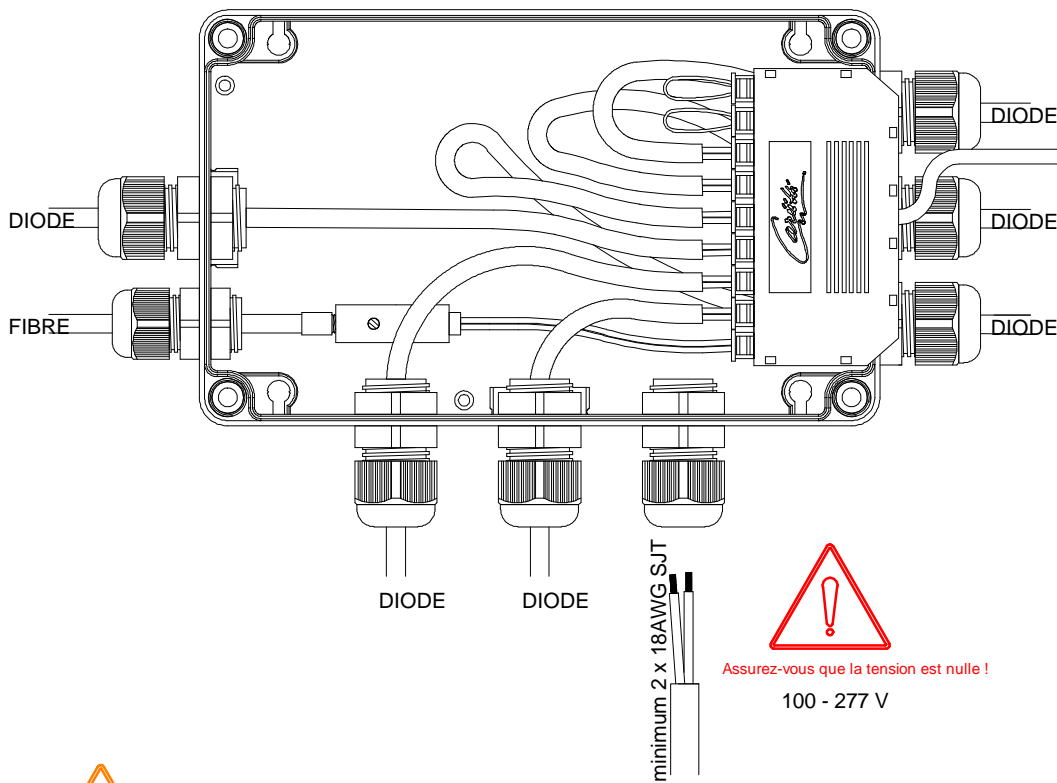

Ne jamais brancher ou débrancher les diodes lorsqu'une tension est appliquée. Provoque la défaillance des diodes.

ENTRÉE 100 - 277 V

FR



Assurez-vous que la tension est nulle !

100 - 277 V

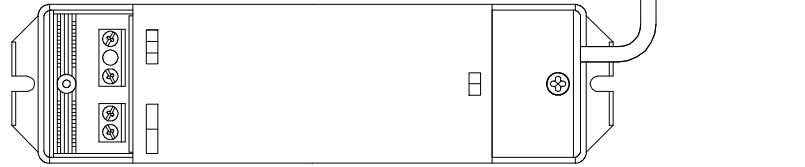
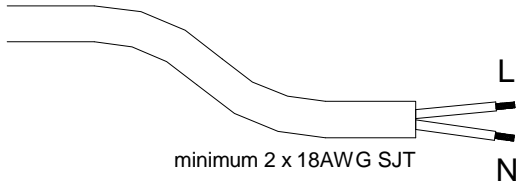

Assurez-vous que la tension est nulle !

100 - 277 V

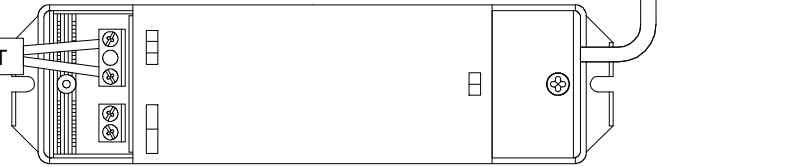
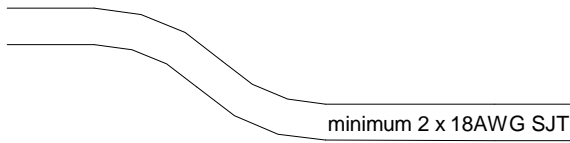

Assurez-vous que la tension est nulle !

100 - 277 V

