

comfee'

12-in-1 Programmable Electric Pressure Cooker

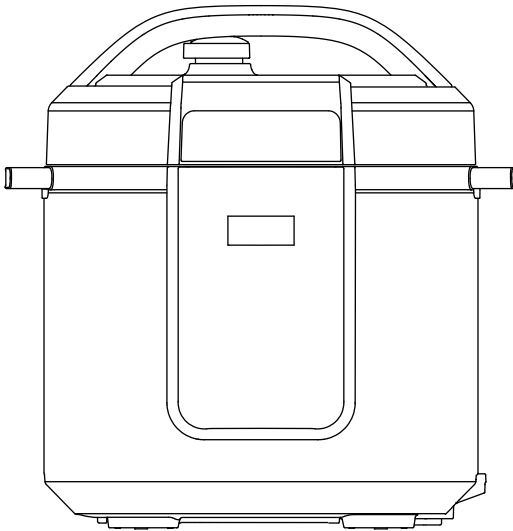

Model: CPC60D7ASB

IMPORTANT NOTE: For your safety and continued enjoyment of this product, always read the instruction book carefully before using.

IMPORTANT PRECAUTIONS

CAUTION

READ ALL INSTRUCTIONS.

1. Do not touch hot surfaces of pressure cooker. Use handles only.
2. To protect against electric shock, do not immerse cord, plugs, or outer vessel in water or other liquids.
3. This appliance should not be used by or near children or individuals with certain disabilities.
4. Unplug from outlet when not in use and before cleaning. Allow to cool before putting on or taking off parts.
5. Do not operate any appliance with a damaged cord or plug, or after the appliance malfunctions or has been damaged in any manner. Return appliance to the nearest authorized service facility for examination, repair, or adjustment.
6. Use of accessories not specifically recommended by the appliance manufacturer may cause injuries or damage to the unit.
7. For household use only. Do not use outdoors.
8. Do not let power cord hang over edge of table or counter, or touch hot surfaces.
9. Do not place the appliance on or near a hot gas or electric burner, or a heated oven.
10. Extreme caution must be used when moving a pressure cooker containing hot liquids or foods.
11. Always attach plug to appliance first, before plugging into wall outlet. To disconnect, turn control to OFF, then remove plug from outlet.
12. Do not use appliance for anything other than intended use.
13. This appliance cooks under pressure. Improper use may result in scalding injury. Make certain unit is properly

IMPORTANT PRECAUTIONS

CAUTION

closed before operating. Please see the “Getting Started” section.

14. Do not fill unit over $\frac{2}{3}$ full (Max line). When cooking foods that expand during cooking, such as dried vegetables, legumes, beans, and grains, do not fill the unit over $\frac{1}{2}$ full. Overfilling may cause a risk of clogging the pressure limit valve and developing excess pressure. Be aware that certain foods, such as applesauce, cranberries, pearl barley, oatmeal and other cereals, split peas, noodles, macaroni, rhubarb, or pasta can foam, froth and sputter, and clog the pressure release devices.
15. Do not open the appliance until the appliance has cooled and all internal pressure has been released. If the float valve is still up and/or the lid is difficult to open, this indicates that the appliance is still pressurized – do not force it open. Any pressure in the appliance can be hazardous. Please see the “Getting Started” section for instructions to safely remove lid.
16. Always check the pressure release devices for clogging or sticking. Both pressure devices must move freely before use.
17. Do not use this appliance for pressure frying with oil.
18. To prevent risk of explosion and injury, replace only dynamic seal ring as recommended by the manufacturer. See Operating Instructions.
19. Do not use under hanging cabinets; steam from pressure release may cause damage.

IMPORTANT PRECAUTIONS

CAUTION

20. **WARNING:** Spilled food can cause serious burns. Keep appliance and cord away from children. Never drape cord over edge of counter, never use outlet below counter, and never use with an extension cord.
21. **CAUTION:** Risk of Electric Shock. Cook only in removable container.
22. This appliance is not intended for deep frying foods.
23. This appliance has a polarized plug (one blade is wider than the other). To reduce the risk of electric shock, this plug is intended to fit into a polarized outlet only one way. If the plug does not fit fully into the outlet, reverse the plug. If it still does not fit, contact a qualified electrician. Do not attempt to modify the plug in any way.

A short power-supply cord is provided to reduce the risks resulting from becoming entangled in or tripping over a longer cord.

Extension cords may be used if care is exercised in their use. If an extension cord is used, the marked electrical rating of the extension cord must be at least as great as the electrical rating of the appliance, and the longer cord should be arranged so that it will not drape over the countertop or tabletop where it can be pulled on by children or tripped over.

WARNING

SAVE THESE INSTRUCTIONS

BEFORE FIRST USE

Tips:



1. Before using your Electric Pressure Cooker for the first time, remove any dust from shipping by wiping clean with a damp cloth.
2. Thoroughly clean the cooking pot and sealing ring assembly in the dishwasher or with warm, soapy water. Rinse, towel or air-dry, and place in the pressure cooker.

Note:

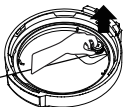

- ① Exhaust valve: Pull out the exhaust valve from the lid. Clean the internal side of the exhaust valve and the exhaust valve and float valve of the lid with brush and cloth at least once a month.
- ② Sealing ring: Please remove oil and dirt from the sealing ring with detergent and brush.
- ③ Water box: After cooking, the steam may stay in the water box of the external pot as water. Water in the box should be removed for avoiding bad odor, please clean it with clean cloth.

Disassemble and install the block proof cover and seal ring

1. Disassemble and install the block proof cover

Disassemble: Pull it out upwards	Block proof cover 
Install: Press it down to install	

2. Disassemble and install the seal ring

Disassemble: Pull it out upwards	Seal ring 
Install: Press it down to install	

NOTE:

1. Check if the seal ring and block proof cover are correctly installed in the upper cover before use each time.
2. After use, please clean the seal ring and around of block proof cover for avoiding jamming the cover, keep it clean to avoid bad odor.
3. Please do not pull the seal ring, otherwise, the distorted seal ring may influence the seal and pressure effect.
4. Do not use the damaged seal ring, please replace it at the authorized repair office.

OPERATING INSTRUCTIONS

1 Opening the lid correctly

Hold the handle of upper cover, turn it anticlockwise for about 30° till the lid at unlock state, and then lift the upper cover.

2 Check if the parts and accessories of lid are well installed

Check if the floater valve and exhaust valve are jammed, confirm if the sealing ring and block proof cover are correctly installed.

3 Take out the inner pot, put food content and water into the inner pot

The total amount of food content and water shall not exceed the Max marked on the inner pot.

4 Put the inner pot into the cooker

Wipe to clean the external surface of inner pot, foreign object and water are not allowed on the inner surface of electric pressure cooker;

Turn the inner pot to left and right to ensure good contact with the heating plate.

5 Safely close the lid

Before closing the lid, check if the sealing ring is well installed.

Hold the handle of upper cover, aim the lid in an "unlock state", put the top cover horizontally on the cooker body, turn the upper cover clockwise for about 30° to the lock place as "Lock State".

6 Placing exhaust valve

When working, please turn the exhaust valve to the sealing location, which means the electric pressure cooker keeps at sealing state;

For manual exhaust, please turn the exhaust valve handle to the exhaust location, the electric pressure cooker keeps at the exhaust state;

when exhausting, do not keep the hands or face above the exhaust opening; Check if the floater valve drops down before working (before heating, the floater valve is down).



Unlock State

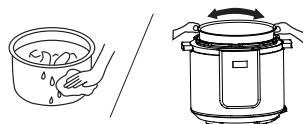
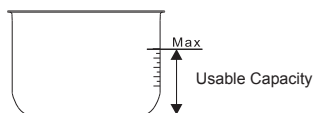

Lock State

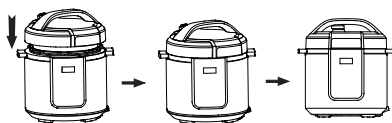

(Picture are for reference only, actual product may differ from picture shown)

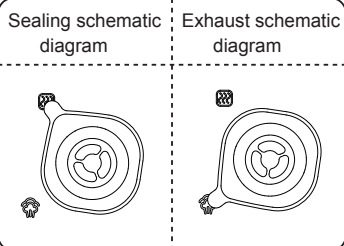

PRESSURE COOKER FUNCTIONS

1. Power on if the buttons are inactive when use, please confirm if the lid is closed at the right place, the buttons are inactive if the lid is not closed correctly.
2. After cooking, the cooker may automatically enter into the keep warm state. The indicator display “0H(0 hour), 1H(1 hour), 2H(2 hour)... “or” L0:00(0 min), L0:01(1 min)...”

Tips:



When the cooker is working, it is normal that it makes “clicking” sound. No need to panic.

To cook small amount of foods, the inner pot may possibly lift when opening the lid, please shake the lid to drop the inner pot in the cooker base and then remove the lid.

SAFETY FEATURES

1. Cut off power supply or remove the power plug
2. **Quick Pressure Release**
 - A. Quickly open the lid (For non-fluid foods)
Turn the exhaust valve to the exhaust location for exhaust release. For some units, by pressing steam release button “” till the float valve drops down.
 - B. Generally open the lid
Keep the electric pressure cooker cool naturally till the float valve drops down.
3. **To Remove Lid**
Turn the upper cover anticlockwise with the left hand, turn it to the cover open limit place, lift the upper cover with the right hand to open the lid.
Do not open the lid before the pressure in the pot has been completely released, do not open the lid fiercely if it is difficult to open.
Do not pull out the exhaust valve when turning the exhaust valve.
After cooking fluid foods (porridge and soup), do not turn the exhaust valve or press the steam release button please cut off power supply to make it cool naturally till the float drops before opening the lid.

PRODUCT INFORMATION

Model	Capacity	Power Supply	Rated Power	Size of Inner Pot	Working Pressure	Keep Warm Temperature
CPC60D7ASB	6 Quart	120V~ 60Hz	1000W	8.66"	0-60kPa	140° F~176° F
Accessories	Spoon 	User Manual 	Power Cord Components 			

PARTS AND FEATURES

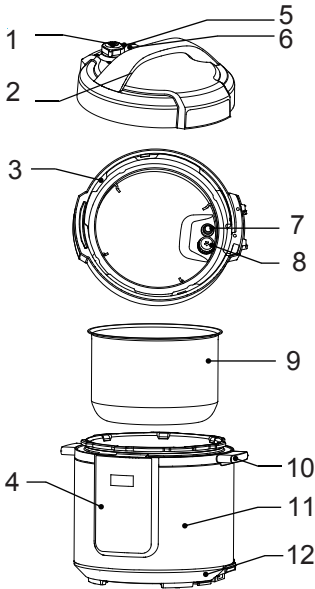

No.	Description
1	Exhaust Valve Handle
2	Upper Cover Handle
3	Seal Ring
4	Control Panel
5	Exhaust Opening
6	Float Valve (Pressure Indicator)
7	Sealing Ring
8	Block Proof Cover
9	Inner Pot
10	Side Handle
11	Outer Body
12	Base

Control Panel

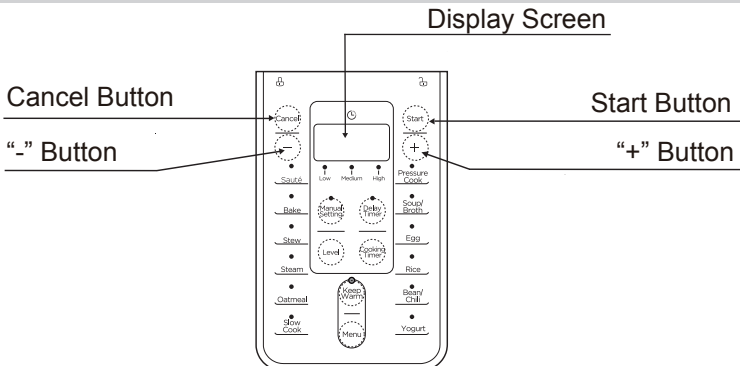

FUNCTION SELECTION

OPERATING INSTRUCTIONS

FUNCTIONS	OPERATING INSTRUCTIONS
Cancel	Under any state, press “Cancel” button to cancel the current work state and return standby state.
Keep Warm	Under standby state, press “Keep Warm” button, the indicator light is on and the digital screen shows default working time. Press “Cooking Timer” button, then press “+” or “-” button to adjust the working time. Press “Start” button to enter into keep warm state. “Keep Warm” indicator light is on and the digital screen shows default working time. Press “+” or “-” button to adjust the working time.
Sauté	Under standby state, press “Menu” button, the indicator light is on and the digital screen shows default working time. Press “Cooking Timer” button ,then press “+” or “-” button to adjust the working time. Press “Start” button to enter into cooking state. Starts countdown and enters to standby state when it finishes working.
Bake	Under standby state, press “Menu” button, the indicator light is on and the digital screen shows default working time. Press “Cooking Timer” button, then press “+” or “-” button to adjust the working time.Press “Start” button to enter into cooking state. The digital screen starts countdown as soon as the temperature rise to working temperature. The pressure cooker automatically shifts to “Keep Warm” feature when finished.
Slow Cook/ Yogurt	Under standby state, press the function button, the indicator light is on and the digital screen shows default working time. Press “Cooking Timer” button, then press “+” or “-” button to adjust the working time. Press “Start” button to enter into cooking state. The digital screen starts countdown and the unit enters to keep warm (Slow Cook) or standby state (Yogurt) when finished.

FUNCTION SELECTION

FUNCTIONS	OPERATING INSTRUCTIONS
<p>Stew Soup/Broth Steam Oatmeal Pressure Cook Egg Bean/Chili Rice Manual Setting</p>	<p>After standby state (plugged in, lid closed, and display reads off), press “Menu” button, the indicator light is on and the digital screen shows default working time. Press “Cooking Timer” button, then press “+” or “-” button to adjust the working time. Press the level button to adjust the cook level from low, medium, or high on some settings. Press “Start” button to enter into cooking state. The digital screen starts countdown as soon as the pressure rise to working pressure. Enters into keep warm when it finishes working.</p> <p>For example: Add food and ensure at least a cup of liquid is inside. Plug in and close the lid. Press the Menu button 7 times to get the Pressure Cook LED to light up. Press Level button to rotate the cooking level setting between light, medium, and high. Press the cooking time button and then the + or - button to adjust the cook time. When done, press start to begin the cooking the food.</p>
<p>Delay Timer</p>	<p>Delay cooking: Before the program starts, press “Delay Timer “ button.</p> <p>The screen shows the preset beginning time. Press “Cooking Timer” button, then press “+” or “-” button to adjust the delay time. Then press “Delay Timer” button to change Hour and Minute. Press “Start” button, the unit starts delay time count-down. When it counts-down to the end, the program starts working.</p> <p>NOTE: Yogurt、Sauté、Bake、Keep Warm function cannot set the delay timer.</p>
<p>Level</p>	<p>Before the program starts, you can press the “Level” button to change the internal cooking pressure for “Low” or “Medium” or “High”. Low is more tender and high is less tender.</p>









FUNCTION SELECTION

Smart Program	Setting	Default Cooking Time (adjustable)	Cooking Timer Range	Delay Timer Range	Keep Warm
Sauté	High	00:30	00:01~00:30	-	-
	Medium				
	Low				
Bake	High	00:45	00:01~01:00	-	10h
	Medium	00:40			
	Low	00:35			
Stew	High	00:45	00:01~04:00	00:10~24:00	10h
	Medium	00:40			
	Low	00:20			
Steam	High	00:15	00:01~04:00	00:10~24:00	10h
	Medium	00:10			
	Low	00:03			
Oatmeal	High	00:30	00:01~04:00	00:10~24:00	10h
	Medium	00:05			
	Low	00:01			
Slow Cook	High	04:00	00:30~24:00	00:10~24:00	10h
	Medium	06:00			
	Low	08:00			
Pressure Cook	High	00:45	00:01~04:00	00:10~24:00	10h
	Medium	00:40			
	Low	00:10			
Soup/Broth	High	03:00	00:01~04:00	00:10~24:00	10h
	Medium	00:40			
	Low	00:10			
Egg	High	00:08	00:01~04:00	00:10~24:00	10h
	Medium	00:05			
	Low	00:03			
Rice	High	00:15	00:01~04:00	00:10~24:00	10h
	Medium	00:12			
	Low	00:08			
Bean/Chili	High	00:45	00:01~04:00	00:10~24:00	10h
	Medium	00:40			
	Low	00:20			
Yogurt	High	boil	-	-	-
	Medium	08:00	00:30~99:30		
	Low	24:00			

SAFETY FEATURES

To avoid personal injury and property loss, be sure to observe the following safety precautions.

• Warning Symbols:

 Means "Forbidden" items	 General Forbid	 Disassemble Forbidden	 Wet hands Forbidden
	 Contact Forbidden	 Spray Water Forbidden	
 Means "Mandatory" items	 Must be executed	 Remove the power plug	

• The danger caused by mistaken use if following warnings are neglected includes to two grades

 **Warning** | It may possibly cause death or serious injury if the warnings are ignored.

 **Caution** | It may cause physical injury or property damage if the caution items are ignored.

Warning

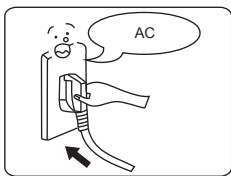

Use correct power outlet (Refer to the label)

- Failure to use correct power outlet can result in a fire or possible electric shock.

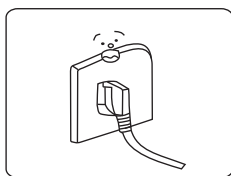

A socket shall be used alone

- A socket of more than 10A rated current with ground-wire can be used alone;
- If shared with other electrical appliances, the socket may cause an electric overload heat and result in fire.

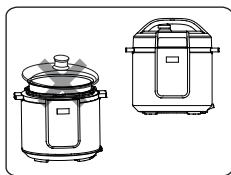

It is strictly prohibited to use other lid

- It is strictly prohibited to use other lid for heating, and in the (switching on) process, the use of non-original lid is not allowed.
- As this may cause electric shock or safety hazards.

SAFETY FEATURES

Warning

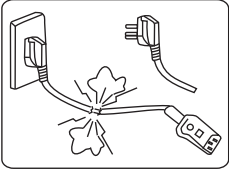

Stop using if the power cord is damaged

- Replace the damaged power cord with special soft cord or replace it with special assembly purchased from the manufacturer or authorized repair center.

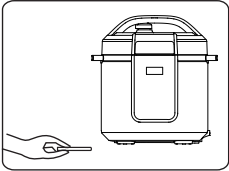

Do not use foreign objects

- It is prohibited to insert metal shavings, needles and other foreign matter in the gap.
- Use of accessories not specifically recommended by Comfee' may cause damage to unit or electric shock.

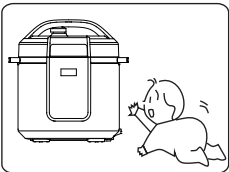

Place the appliance in a location out of reach of infants

- This appliance should not be used by or near children or individuals with certain disabilities.
- This appliance cooks under pressure. Improper use may result in a scalding injury. Make certain unit is properly closed before operating.

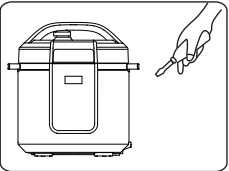

Modification is prohibited

- Modification or repair by non-professionals is prohibited.
- Violation may cause a fire or electric shock.
- Repair or replacement of parts shall be made in a designated service center.

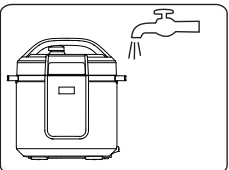

Products may not be immersed or sprinkled in water or other liquids

- Doing so could cause electric shock and electrical short circuits.



SAFETY FEATURES

Warning

Warning on opening the lid

- When the electric pressure cooker is not working, there isn't pressure in the pot, the float valve is down;
- When the electric pressure cooker is working, pressure in the cooker rises, float valve ascends; do not force open the lid before the pressure has been completely released;
- If it is difficult to open the lid, please do not open it with force, otherwise, it may cause scalding or physical injury.

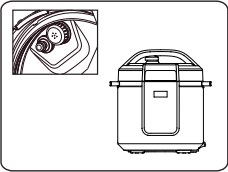

Check periodically

- Be sure to check periodically the block proof cover and exhaust valve core to make sure that they are not be blocked;
- Do not cover the exhaust valve with heavy object or replace it with other object.



Caution

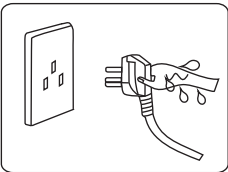

Never pull the plug with a wet hand

- To avoid electric shock.

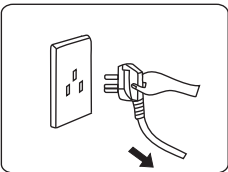

When pulling the plug, you must pinch the plug

- Do not pull the power cord, otherwise it will damage the cord, causing electric shock and short circuit.

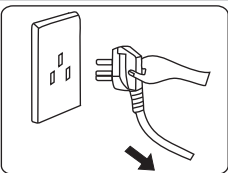

Unplugging when not in use

- Otherwise, it may produce leakage, fire or failure.

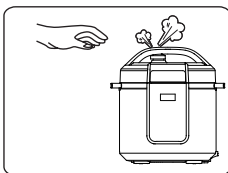

In working, never move your hands to close to the exhaust port.

- In cooking process, never move your hands to close to the exhaust port to avoid burns.
- During cooking, do not cover the vent with a cloth and other items.



SAFETY FEATURES

Caution

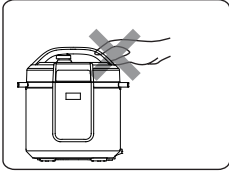

When the cooker is working, please do not touch the lid 

- When the cooker is working, lid has high temperature, do not touch it;
- Otherwise, it may possibly cause scalding.

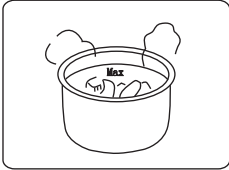

The total amount of food and water can not exceed Max scale

- The total amount of food and water can not exceed Max scale, otherwise food may be cooked unfamiliar, or cause malfunction.

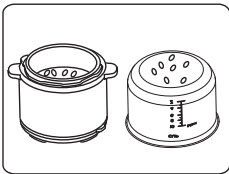

Do not use a pot other than the dedicated pot 

- When there is foreign object on the bottom of pot and heating plate surface, remove the foreign object before use.
- Otherwise, it may cause overheating and work abnormalities etc.

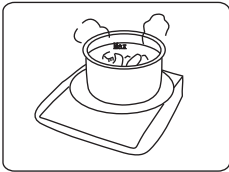

Do not place the pressure cooker in a heated oven or on any stovetop 

- Please use the special inner pot.

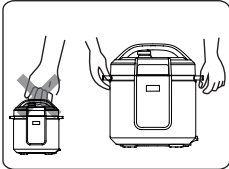

When moving the product, please securely hold the handle of cooker body 

- Extreme caution must be used when moving a pressure cooker containing hot liquids or foods.

Do not use in the following locations 

- Do not use in unstable locations;
- Do not use in locations near water and fire;
- Do not use near walls and furniture;
- Do not use in locations exposed to direct sunlight and oil splatter;
- Do not approach the stove for avoiding fire.

CLEANING AND MAINTENANCE

1. Clean after each use.
2. Before cleaning and maintenance, please unplug the power cord until the product cools.

3. Remove the lid and inner pot, clean with detergent first, then rinse well with water, and wipe dry with a soft cloth.
4. Clean the internal side of the lid with water, the seal ring, block proof cover, exhaust valve core and float valve can be removed for washing, timely and correctly install them after washing, and then dry the internal side of lid with cloth.
5. Wipe clean the body of the Pressure Cooker with a rag, and it is prohibited to soak body of the Pressure Cooker in water or spray water to it.
NOTE: Any other servicing should be performed by an unauthorized service representative.
6. Periodically clean the cooker and remove oil and dirt if it is stored on the table.
7. Place the electric pressure cooker 12cm away from other kitchen appliances.

TROUBLESHOOTING

When followings occur, it is not the cooker fault, please carefully check once before sending it for repair.

S/N	Symptom	Possible Reasons	Solutions
1	Difficult to close the lid	Sealing ring not installed properly	Position the sealing ring well
		The floater valve clamps the push rod	Lightly push the push rod
2	Difficult to open the lid	Float valve in the popped-up position	Press the float valve lightly with a chopstick.
		Pressure exists inside the cooker	Open the lid after the pressure is completely released.
3	Steam leaks from the lid	Sealing ring installed improperly	Install the sealing ring as required
		Food debris attached to the sealing ring	Clean the sealing ring
		Sealing ring damaged	Replace the sealing ring
		The lid is not closed correctly	Close the lid correctly
4	Steam leaks from float valve	Food debris on the float valve gasket	Clean the float valve gasket
		Float valve gasket worn-out	Replace the float valve gasket
5	Float valve unable to rise	Too little food and water in inner pot	Add water and food according to the recipe
		Steam leaks from the lid or exhaust valve	Send to the service center for repair

TROUBLESHOOTING

S/N	Symptom	Possible Reasons	Solutions	
6	Steam comes out from exhaust valve non-stop	Exhaust valve not in sealing position	Turn the exhaust valve to the sealing position	
		Pressure control fails	Send to the service center for repair	
7	Power indicator doesn't light on	Power socket bad contact	Please check the power socket	
8	All indicators flags	Display screen displays E1	Bottom sensor fault	
		Display screen displays E2		
		Display screen displays C1	High temperature since there isn't water in the inner pot	Add water according to the requirement
			High temperature since there isn't water in the inner pot	Insert the inner pot correctly
		Display screen displays E8	Pressure switch fault	Send to the service center for repair
9	Rice half cooked or too hard	Too little water	Add water accordingly	
		Lid opened prematurely	After cooking cycle completes, leave the lid on for 5 more minutes.	
10	Rice too soft	Too much water	Reduce water accordingly	
11	<ul style="list-style-type: none"> Power cord and plug is expanded, deformed damaged and its color has changed. One part of the power cord and plug are hotter. Power cord is flexible with discontinuous power supply. The electric pressure cooker has abnormal heating and generates a bad odor. There's abnormal noise or vibration when powered on. 		Stop using and call our Consumer Service Center	
12	<ul style="list-style-type: none"> There's dust or dirt on the plug or socket. 		Remove the dust or dirt.	

NOTE: Please contact our authorized service center for repair.

Customer Service Management Office: 5 Sylvan Way, Suite 100 Parsippany, NJ, 07054

Amazon Store: <https://www.amazon.com/comfee>

Tel: 866-646-4332

E-mail: officialservice@comfeeappliance.com

