

**LASER PEGS**

**MULTI-  
MODELS**

**4 IN 1**



[www.LaserPegs.com/52011/MANTA\\_RAY](http://www.LaserPegs.com/52011/MANTA_RAY)

x2   
50000A-TPG

x2   
30011-299C

x2   
40010-299C

x2   
10013-299C

x2   
40010-PQ

x1   
60002-TPG

x2   
30012-299C

x20   
40006-299C

x4   
10023-299C

x3   
10012-PQ

x1   
10022-PQ

x1   
60003-TPG

x1   
40003-299C

x5   
50012-299C

x6   
10014-299C

x1   
10023-PQ

x5   
10024-PQ

x4   
60011-TPG

x4   
40011-299C

x8   
90018-299C

x3   
10024-299C

x1   
10028-PQ

x4   
60012-TPG

x3   
40001-299C

x3   
10022-299C

x2   
10016-299C

x2   
10016-Clear

x2   
167-C9121

x1   
40002-299C

x2   
90008-299C

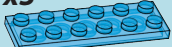
x3   
10026-299C

x1   
LB101-Clear

x2   
10026-Clear

x1   
76-C9121

x2   
40005-299C

x2   
10003-299C

x1   
10028-299C

x1   
10212-Clear

x2



x1

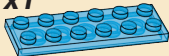

x1

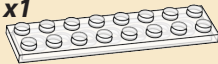

Questions?? email:  
[info@neverwrongtoys.com](mailto:info@neverwrongtoys.com)

Des questions?? Allez à:  
[info@neverwrongtoys.com](mailto:info@neverwrongtoys.com)



Scan for additional model instructions  
Rechercher des instructions supplémentaires sur le modèle

1

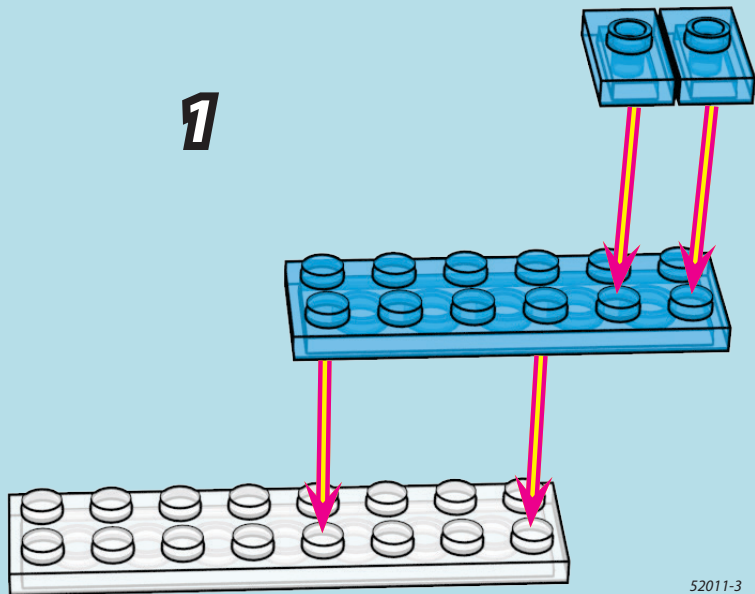

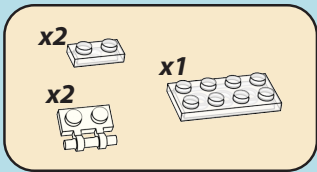

**2**

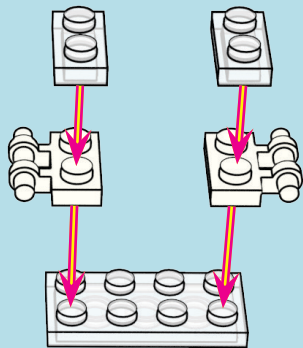

**3**

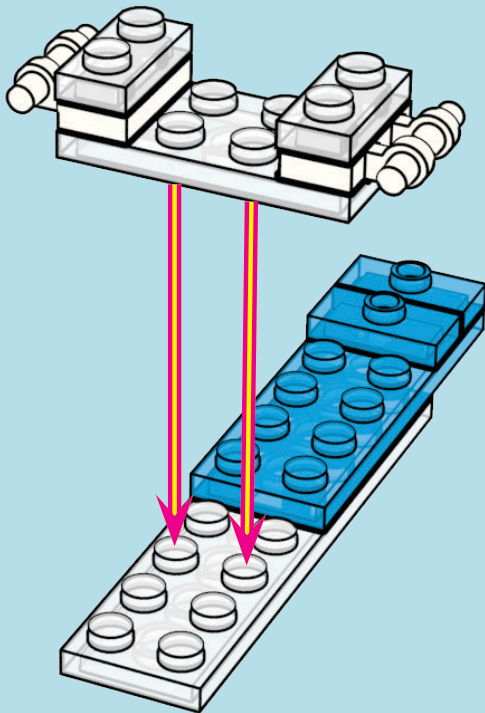

x1



x2



4

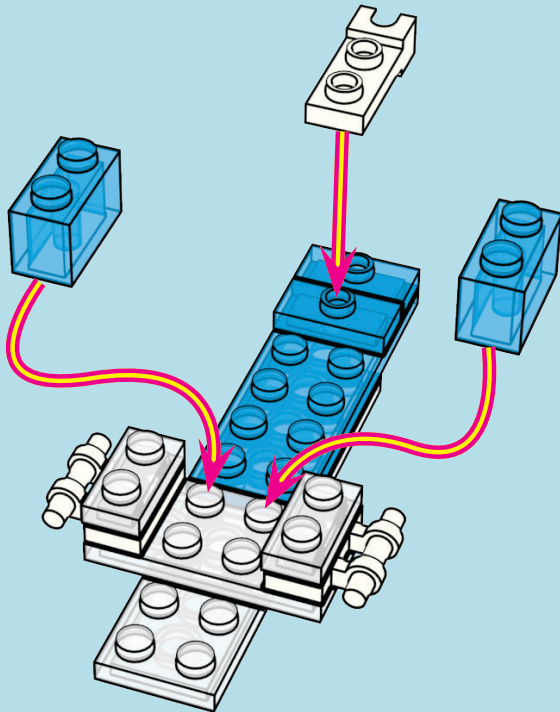

x2



x1



x1



x1

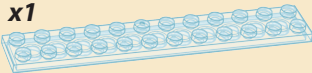

5

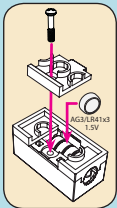
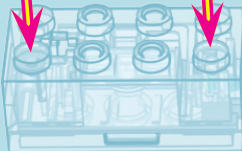
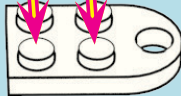
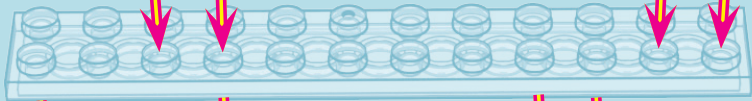
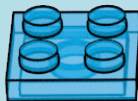

6

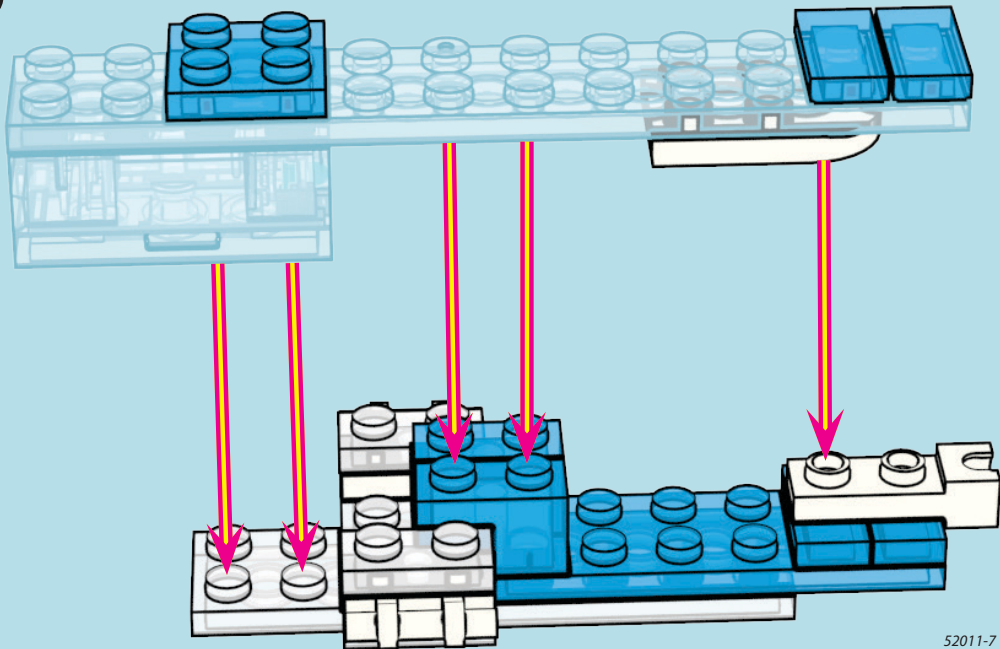

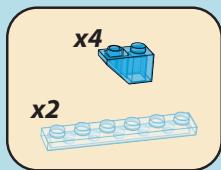

7

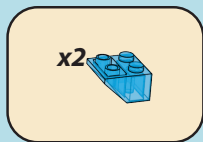
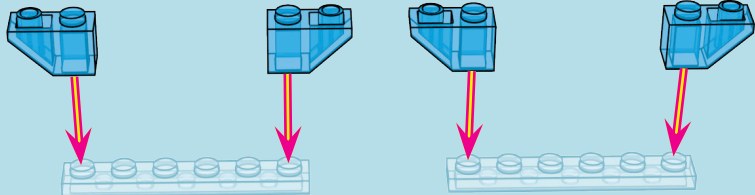

8

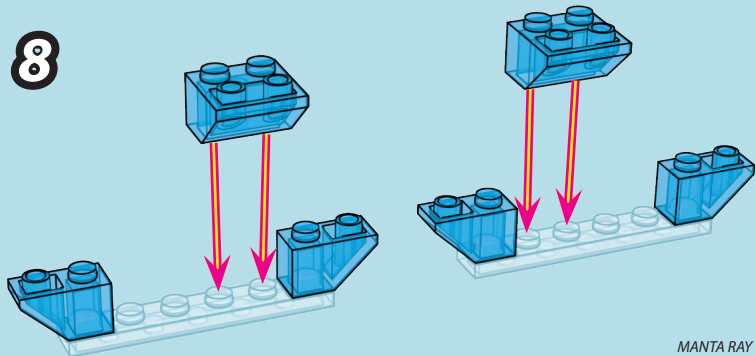



9

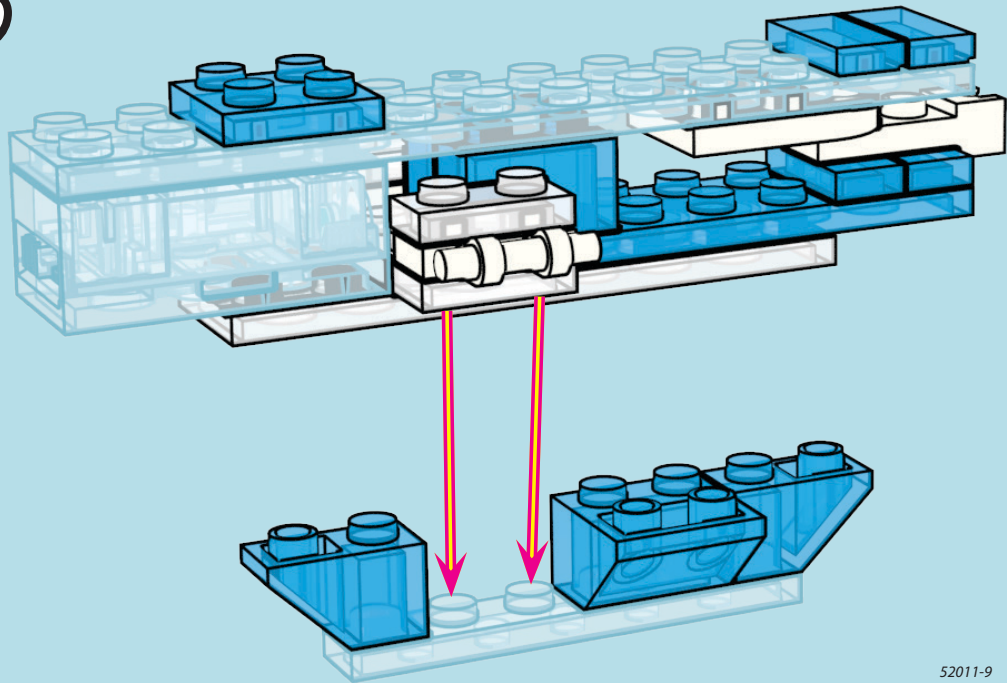

**10**

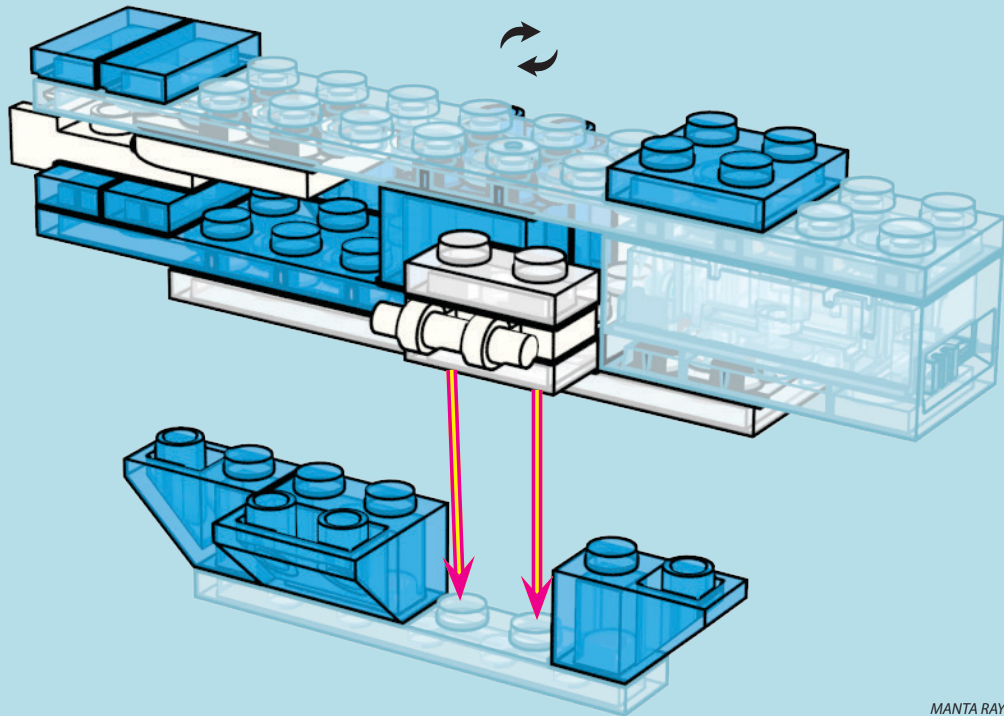

x2



x2



x2

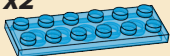

**11**

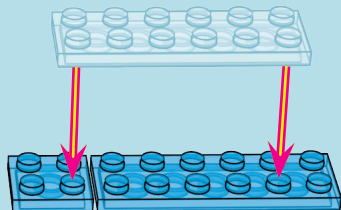
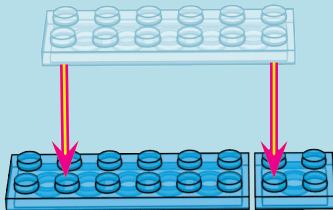

x4



**12**

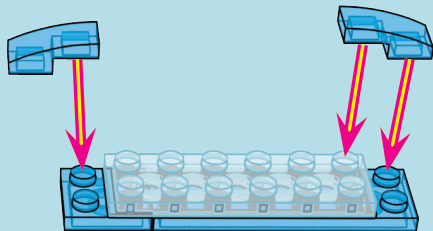
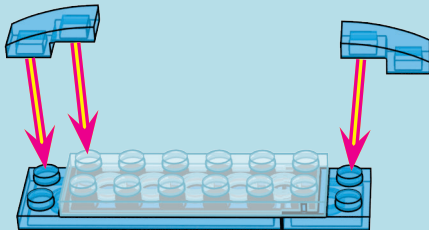

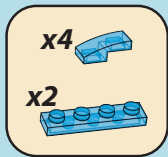

**13**

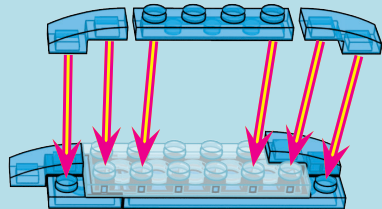
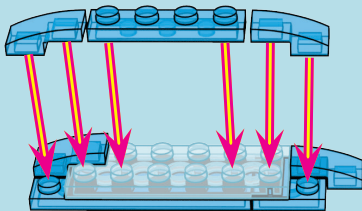

**14**

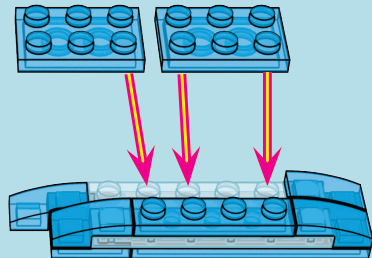
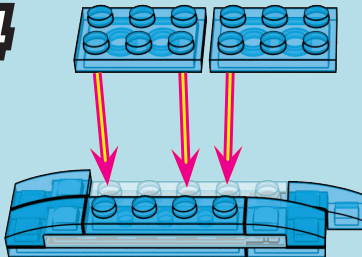

**15**

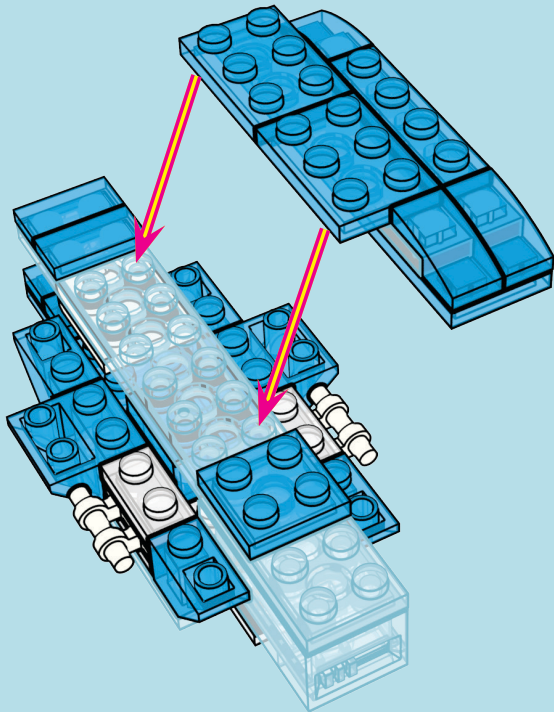

**16**

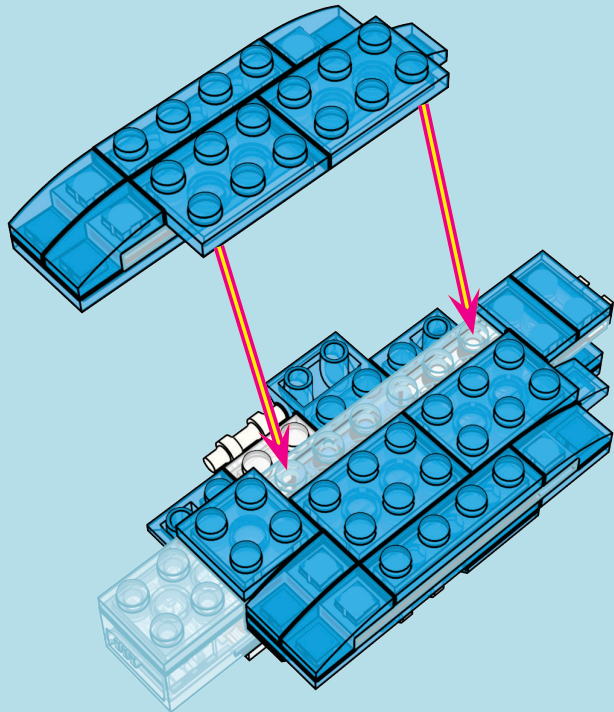



**17**

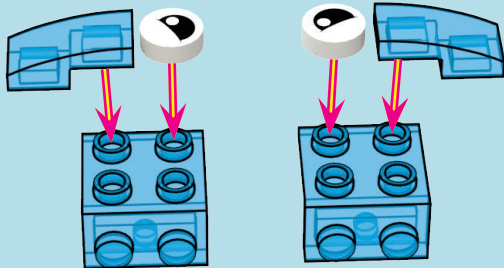

**18**

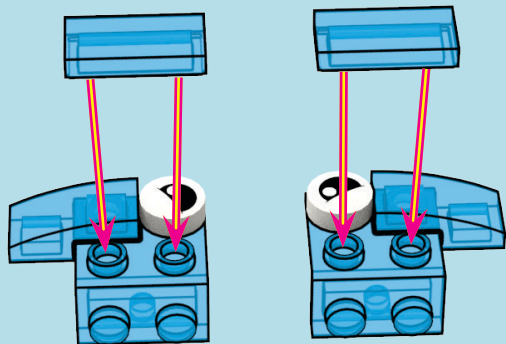

**19**

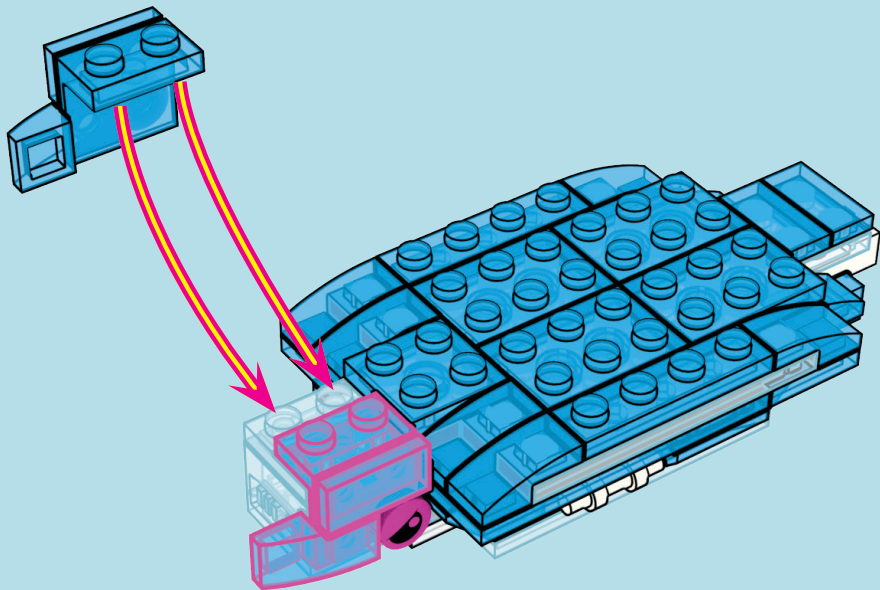



x2

x1

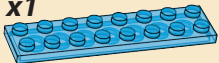

**20**

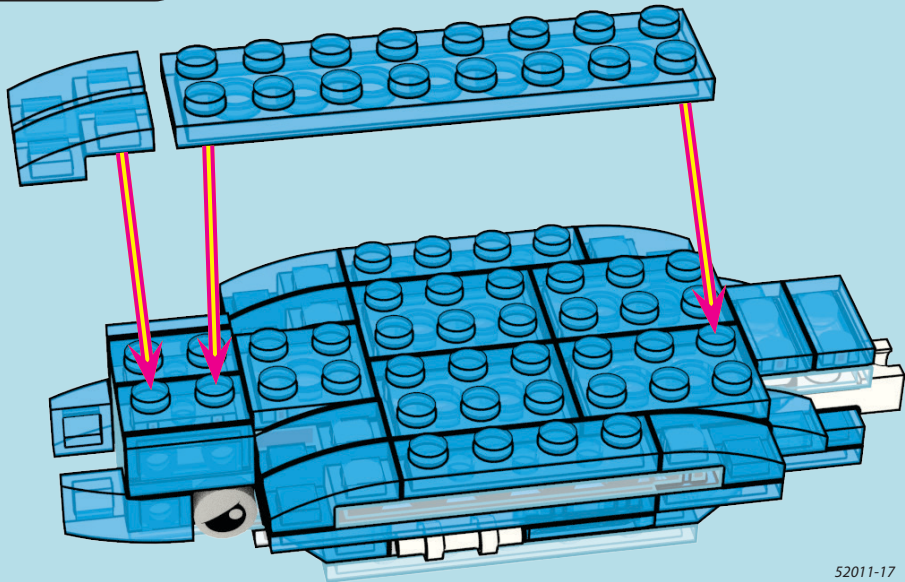

x2



x2



x2

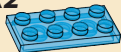

# 21

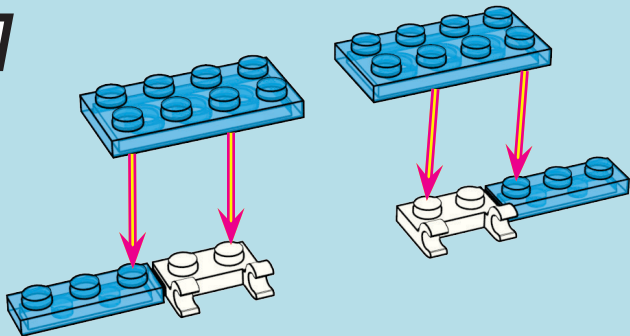

# 22

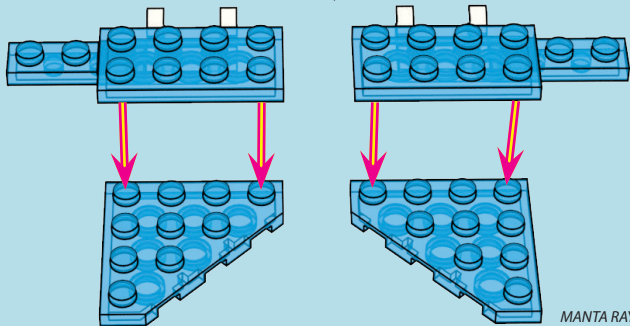

x2

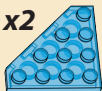

23

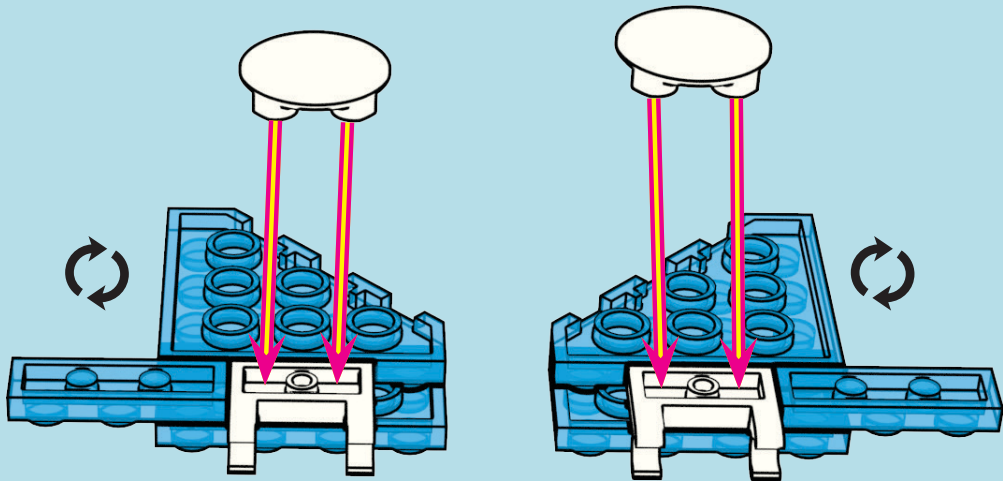
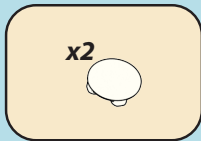

x4



x2



**24**

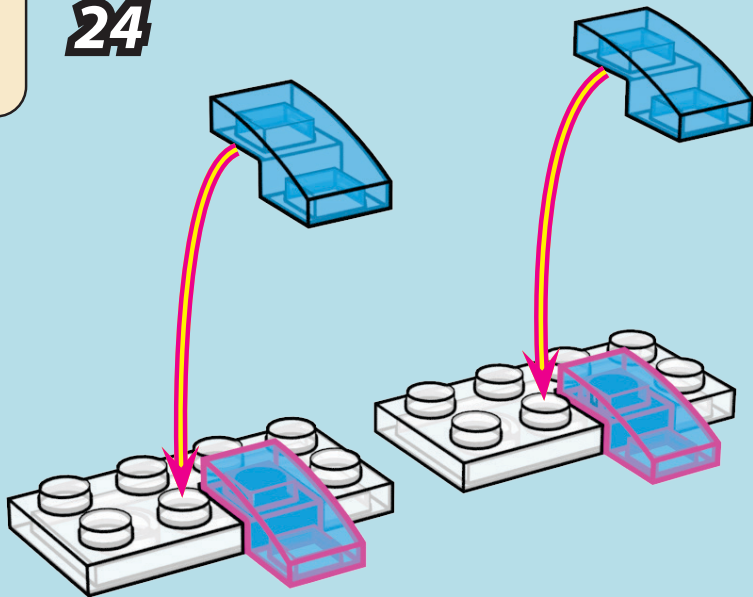

**25**

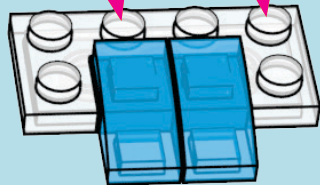
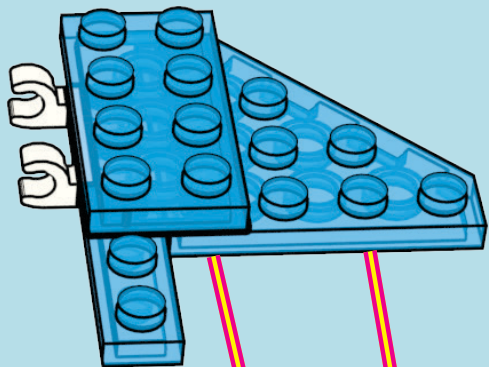
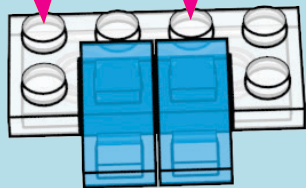
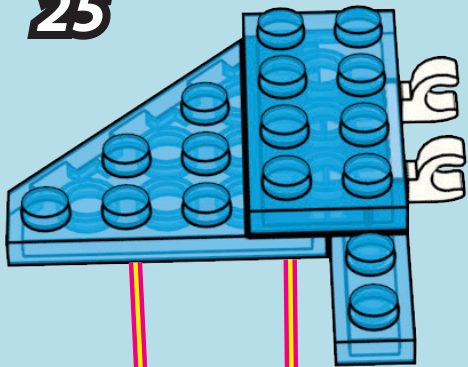

x2



26

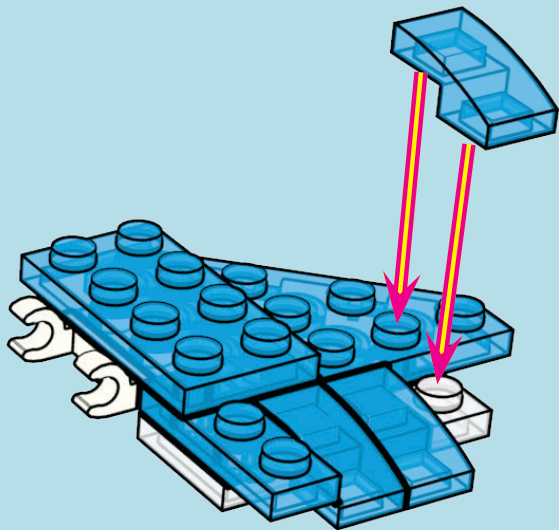
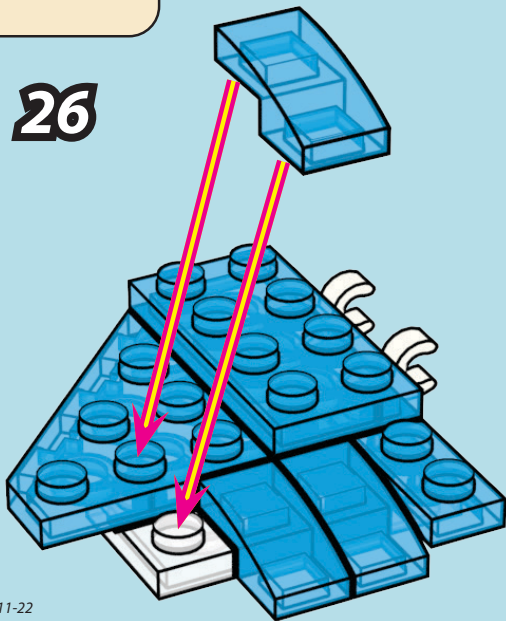

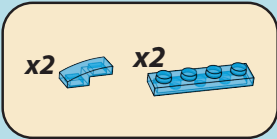
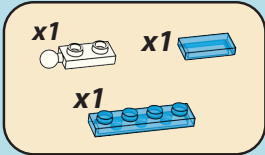

**27**

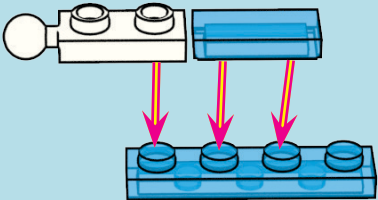

**28**

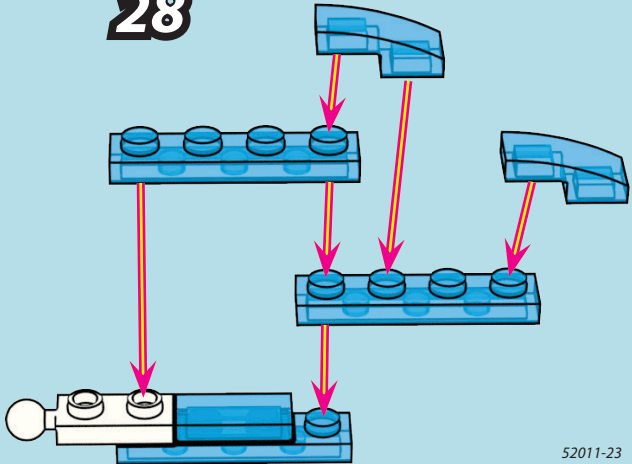

29

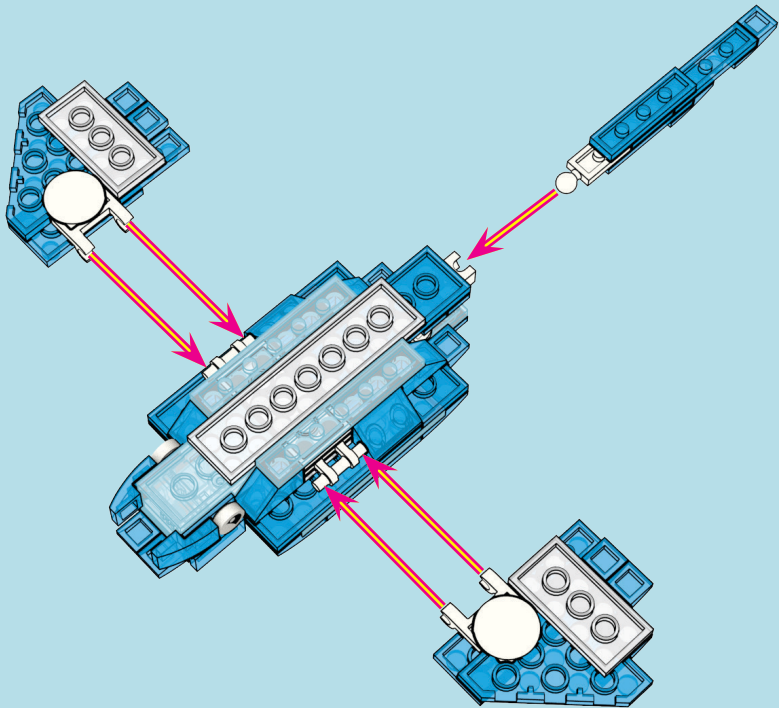



**Questions?? email: [info@neverwrongtoys.com](mailto:info@neverwrongtoys.com)**  
**Des questions?? Allez à: [info@neverwrongtoys.com](mailto:info@neverwrongtoys.com)**

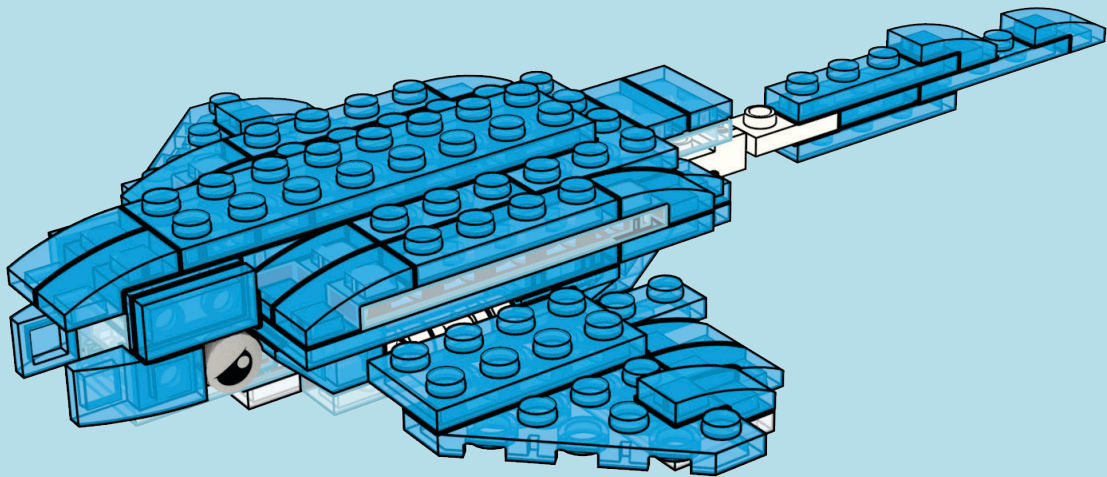

**LASER PEGS**

**MULTI-  
MODELS**

**4 IN 1**



**SEA TURTLE**

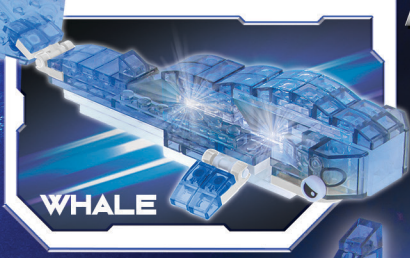

**WHALE**



**MANTA RAY**

**4 WAYS  
TO BUILD!**



**HAMMERHEAD**

**NEVER  
WRONG**  
Toys & Games