

LASER PEGS

**MULTI-
MODELS**

4 IN 1



www.LaserPegs.com/52010/TIGER

x6 
10011-1505C

x1 
60009-1505C

x7 
10012-1505C

x2 
67-36001

x6 
60002-1505C

x6 
60003-1505C

x1 
60011-1505C

x1 
60012-1505C

x1 
90040-1505C

x1 
10014-1505C

x2 
10016-1505C

x4 
40010-1505C

x4 
40006-1505C

x6 
10022-1505C

x1 

303-36001

x2 
262-36001

x4 
60004-1505C

x4 
60005-1505C

x1 
81-36001

x1 
82-36001

x4 
40010-137C

x21 
40006-137C

x4 
40012-137C

x2 
40008-137C

x14 
40009-137C

x2 
40011-137C

x4 
40005-137C

x1 
LB100-137C

x1 
LB101-137C

x9 
10012-137C

x6 
10014-137C

x3 
10022-137C

x2 
10024-137C

x1 
10210-137C

x3 
10012-CLEAR

x3 
10022-CLEAR

x1 
10014-CLEAR

x2 
80000-6C2X

x8 
10011-6C2X

x1 
90018-6C2X

x4 
40010-6C2X

x1 
214-K2048

x6 
40009-10C

x1 
308-K2048

x4 
60-K2048

x2 
10011-TPG

x8 
60008-TPG

x2 
60009-TPG

x4 
10012-TPG

x1 
60011-TPG

x2 
155-C9121

x6 
10013-TPG

x2 
10014-TPG

x2 
40009-PQ

x8 
40010-TPG

x2 
40003-TPG

x4 
269-C9121

x2 
79-C9121

x2 
80-C9121



x1	x1	x2
x1	x2	x2



Scan for additional model instructions
Rechercher des instructions supplémentaires sur le modèle

1

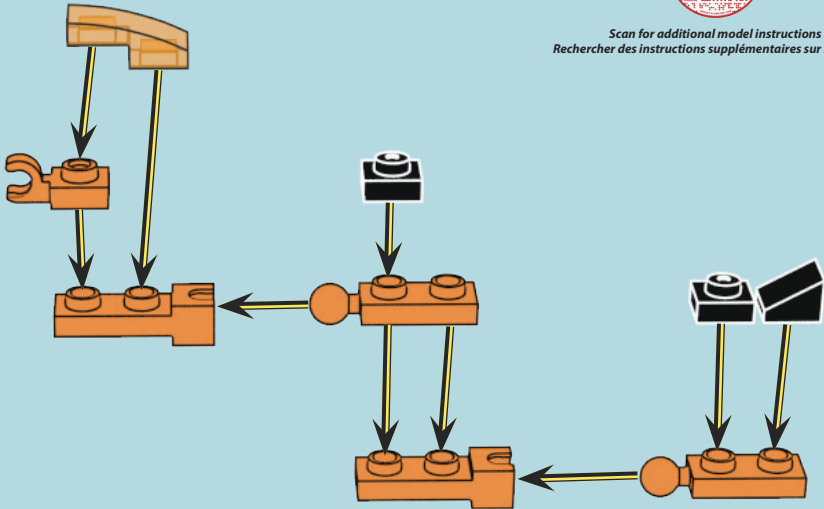

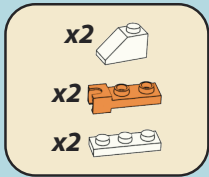
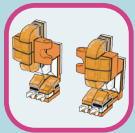

2

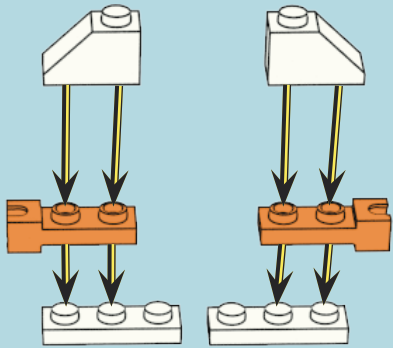

3

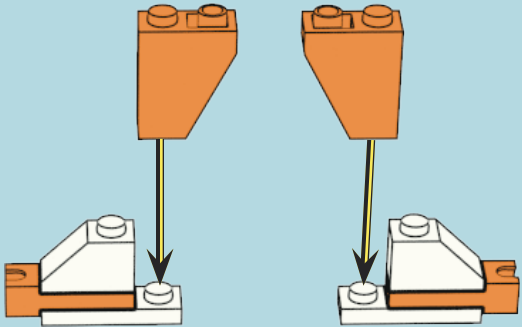

x2 

x2 

4

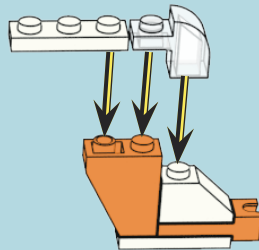
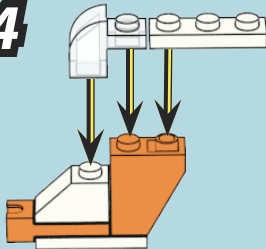

x4 

x2 

5

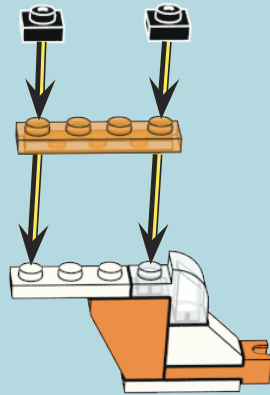
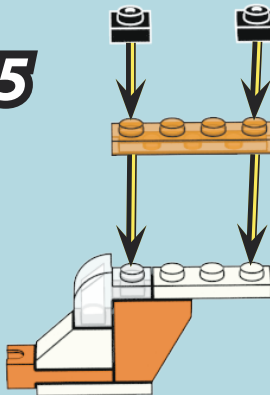

x2



x4



6

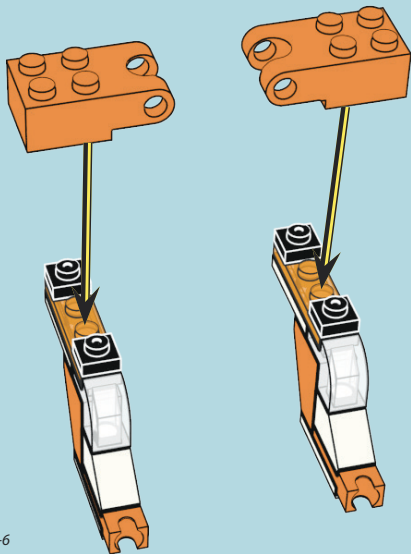

7

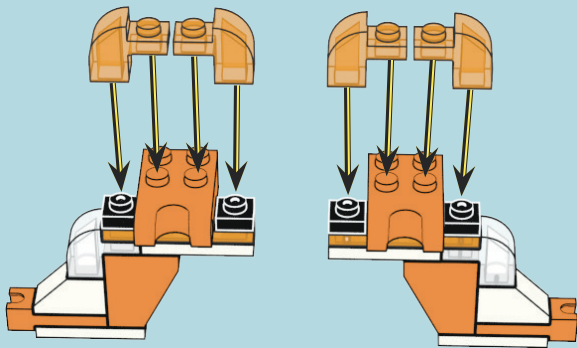

x4



x4



x2



x2



8

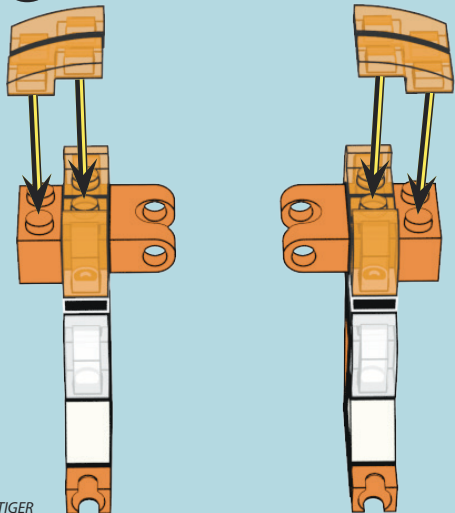

9

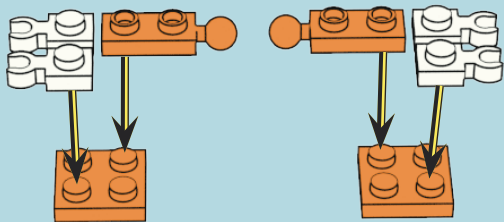

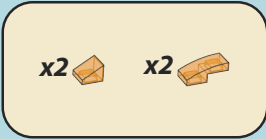
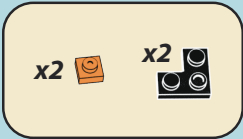

10

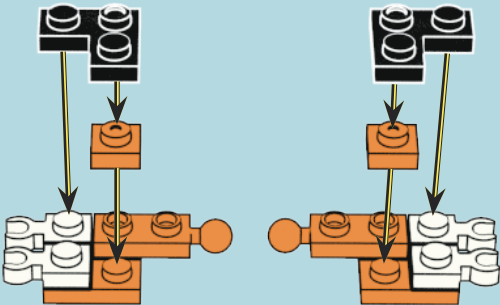

11

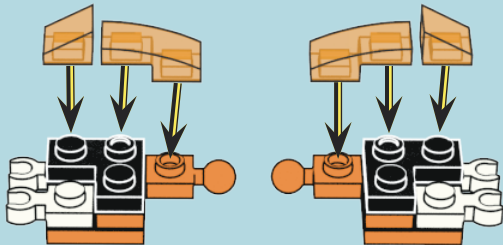

x2



12

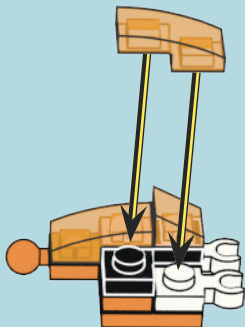
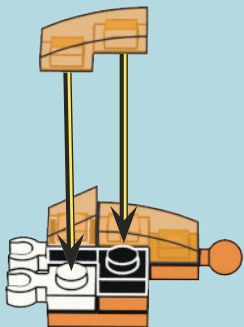

13

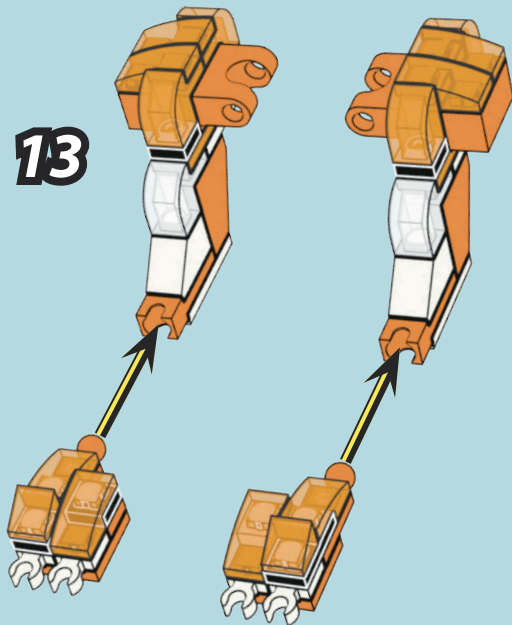

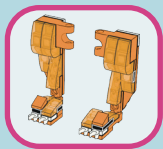

14

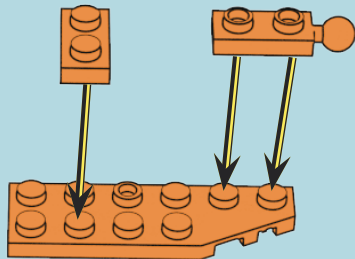
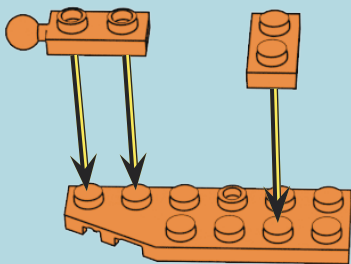

x2

x2

x1

x1

x2

x2

15

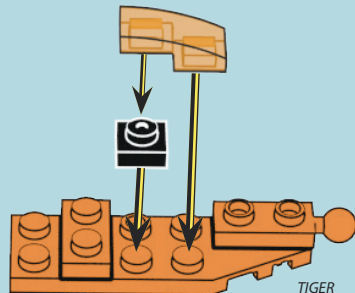
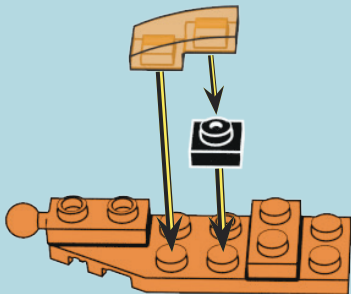

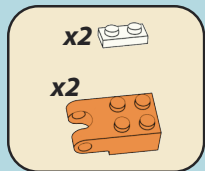

16

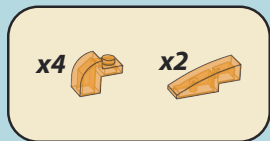
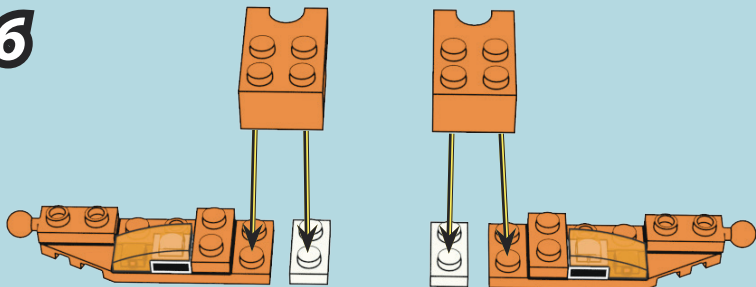

17

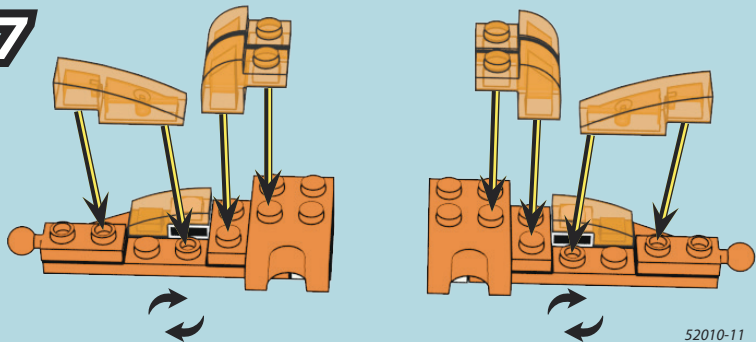

x4 

18

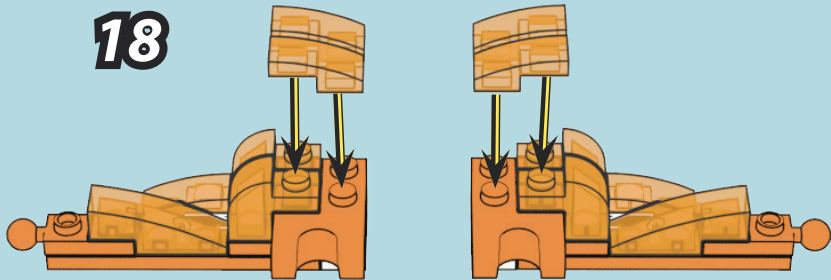

19

x4 

x2 

x2 

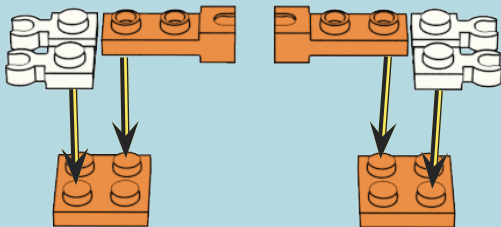

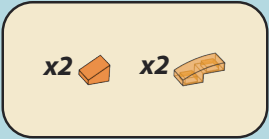
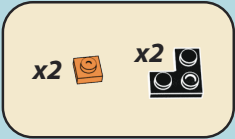

20

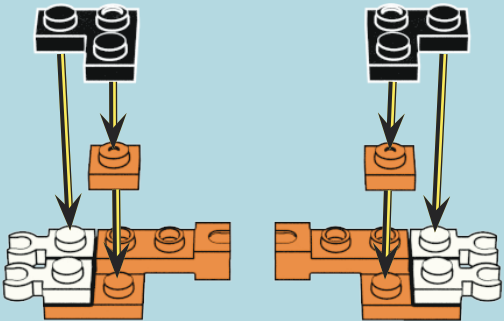

21

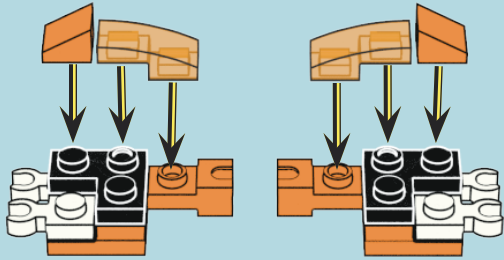

x2



22

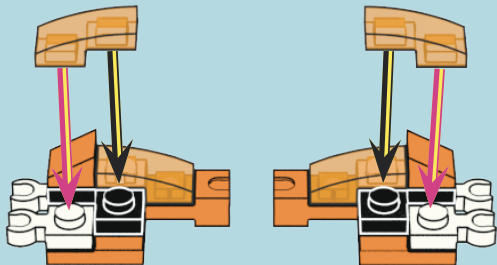

23

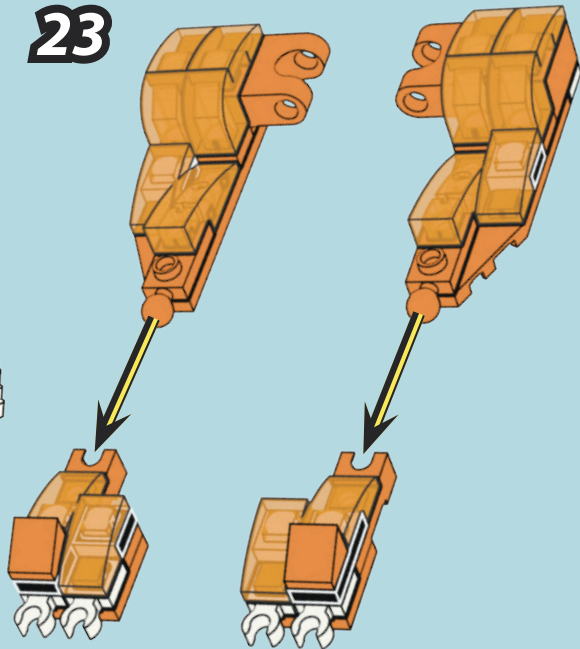



x4



x1



x1



x2



24

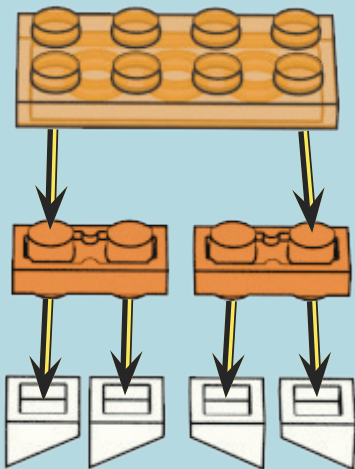

25

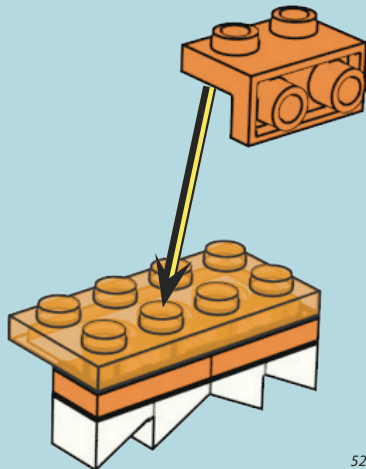

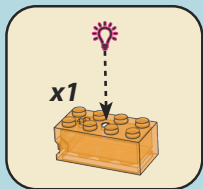

26

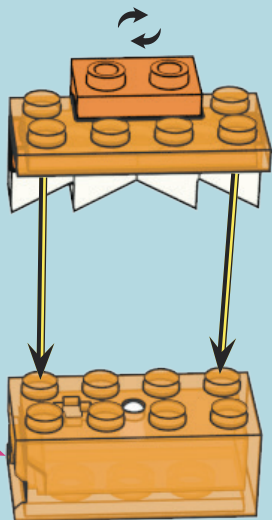

52010-16

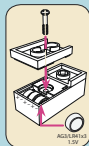

27

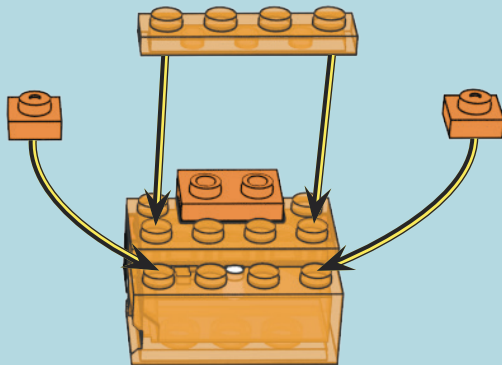

TIGER

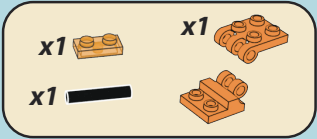

28

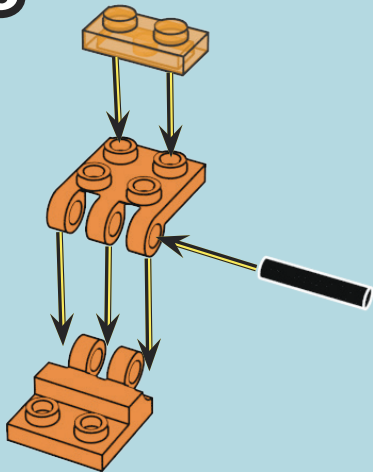

29

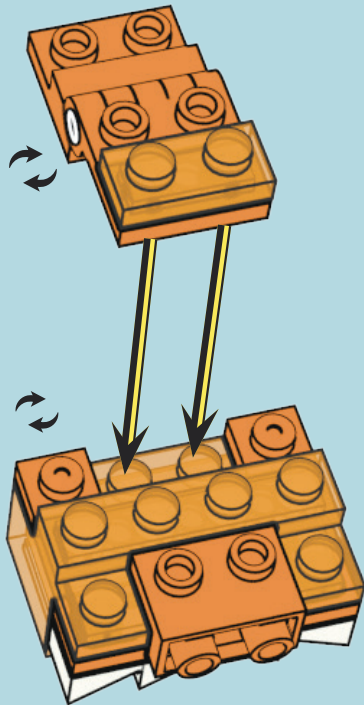

x2



x1



x1



x2



30

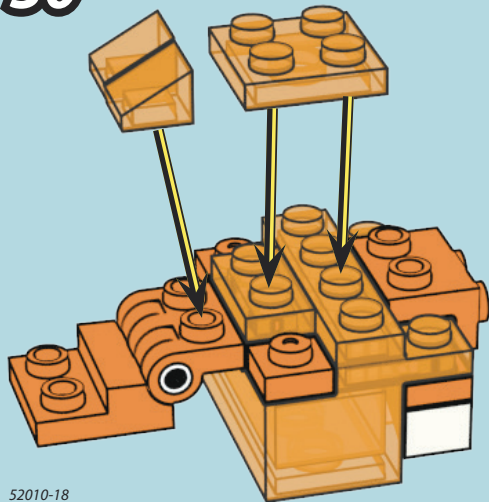

31

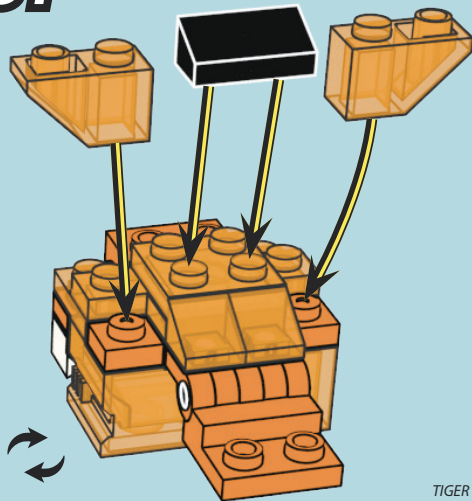

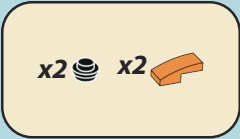

32

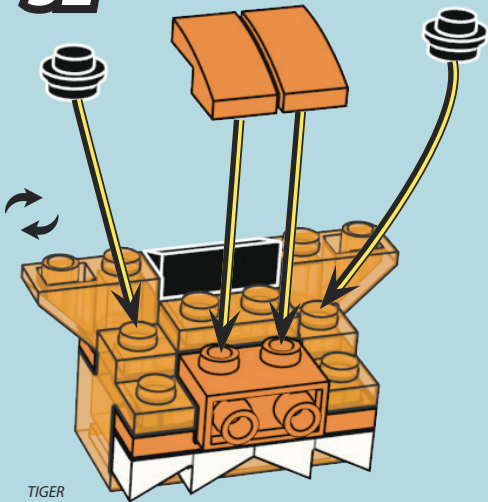

33

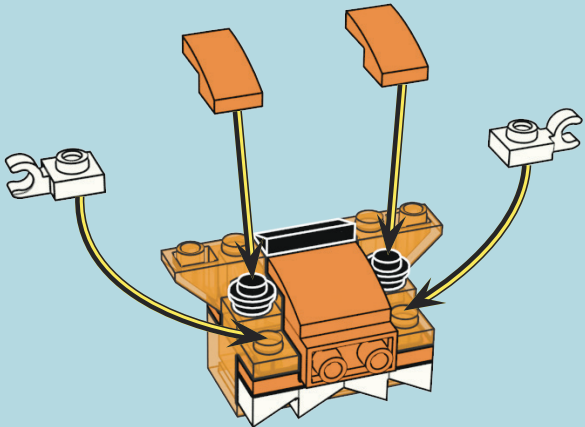

x1 

x2 

x1 

34

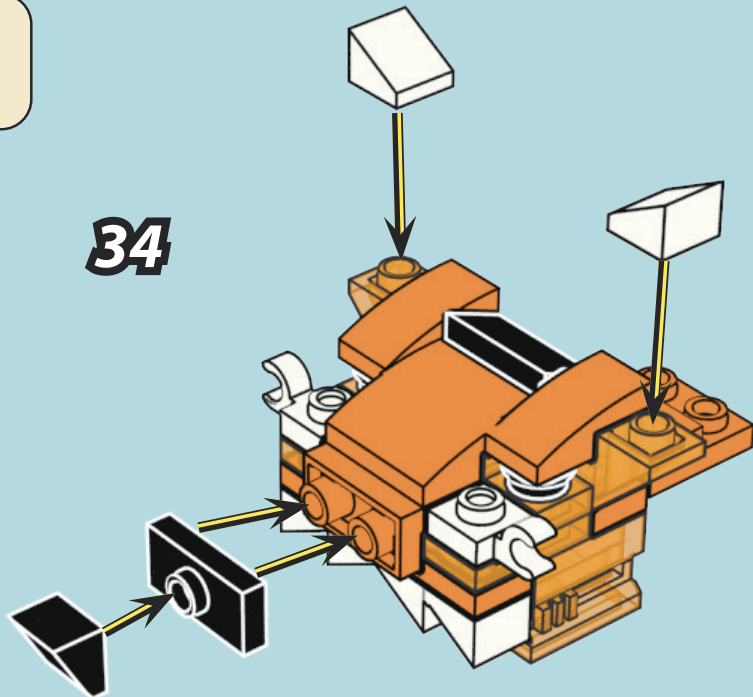

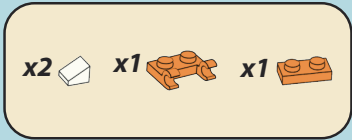
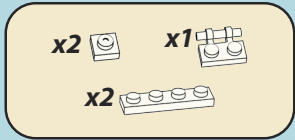

35

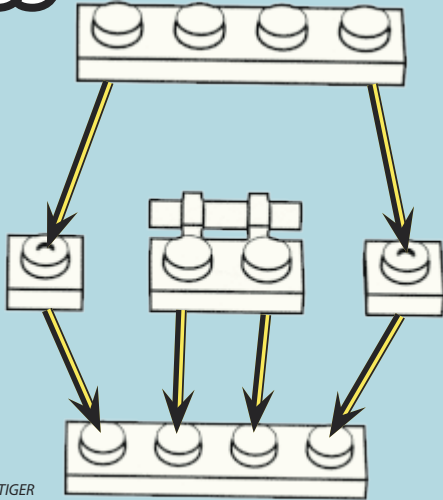

36

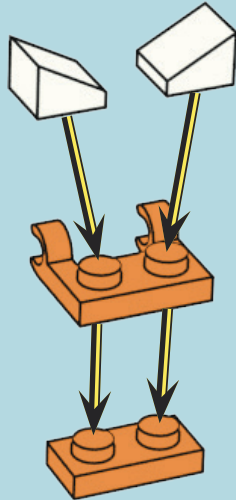

37

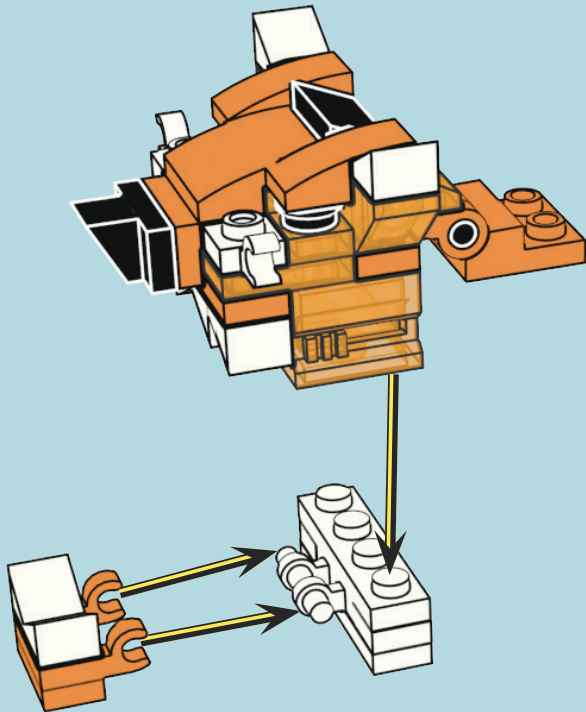

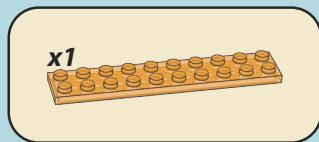
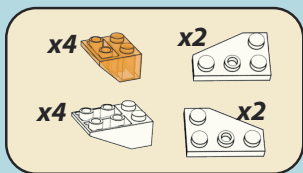

38

x2

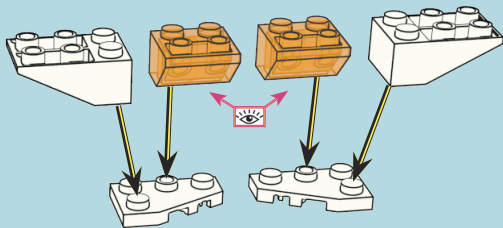

39

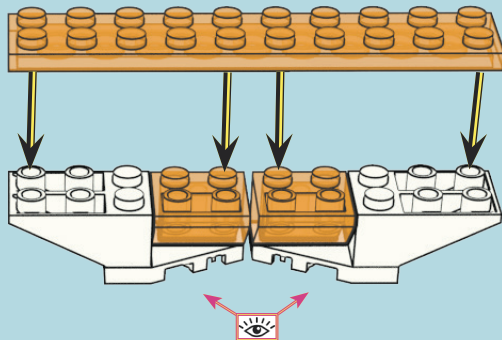

40

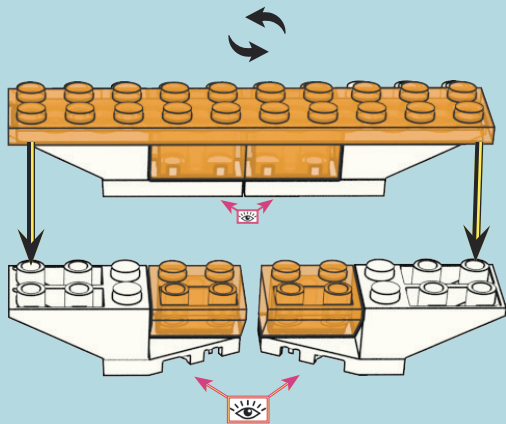

52010-24

x2



x2



41

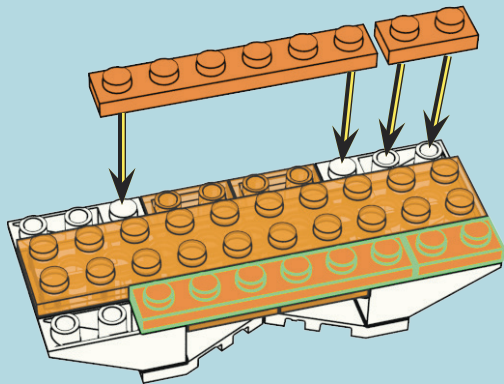

TIGER



42

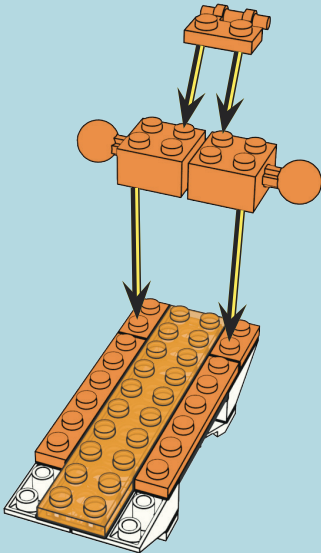

43

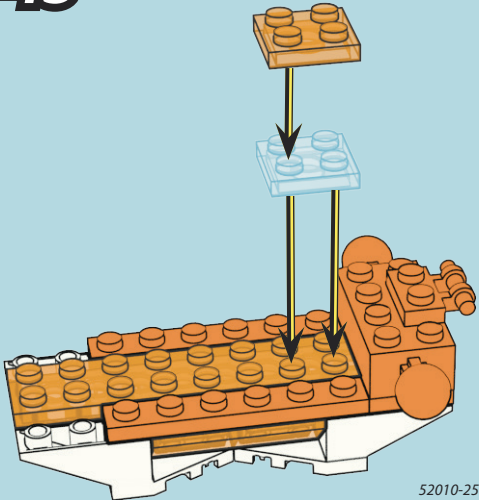

x2



x2



44

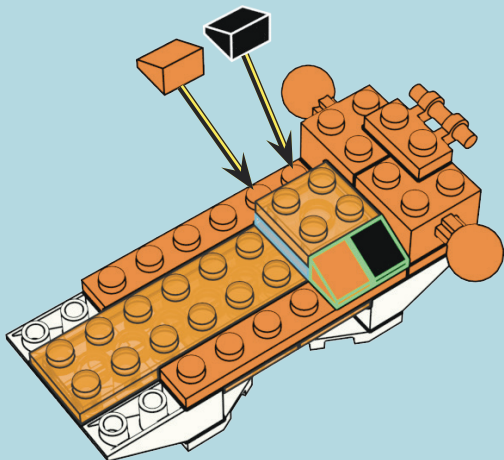

52010-26

x2



x1



45

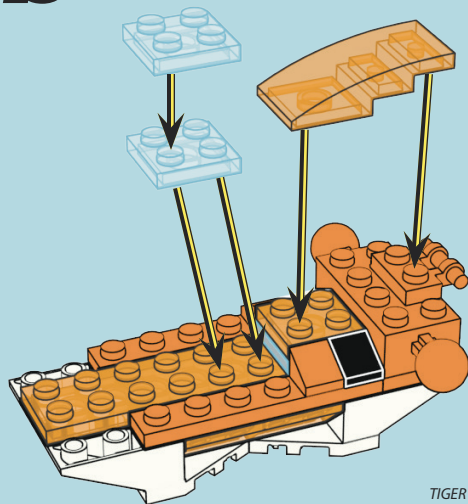

TIGER

x2



x2



46

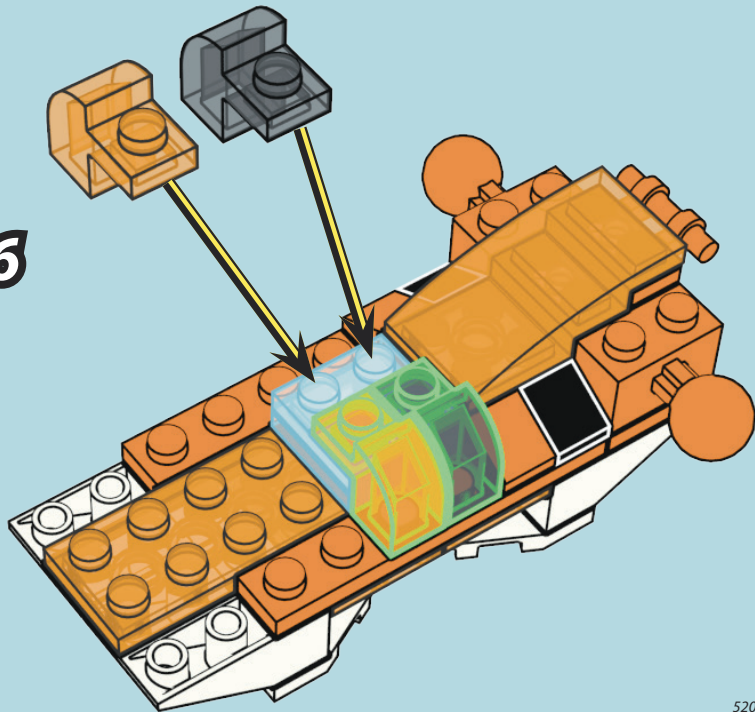

x4



47

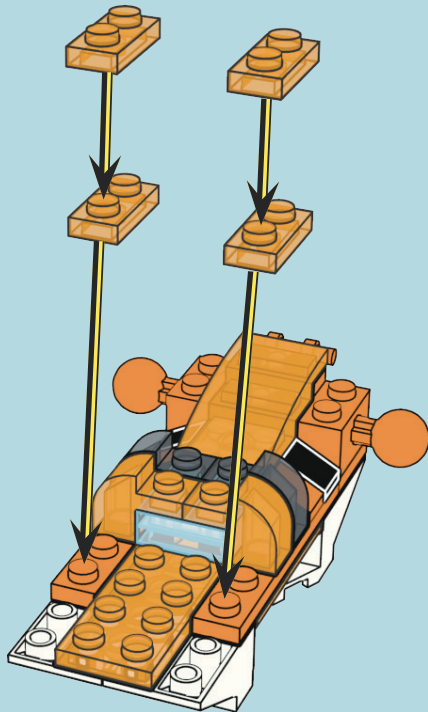

48

x1 

x2 

x1 

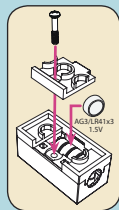
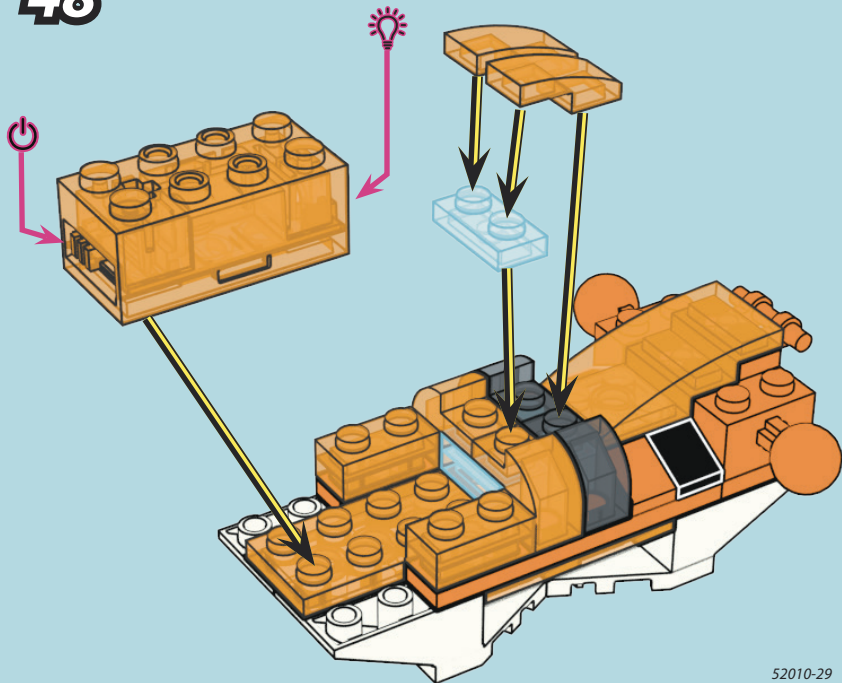

x2  x2 

49

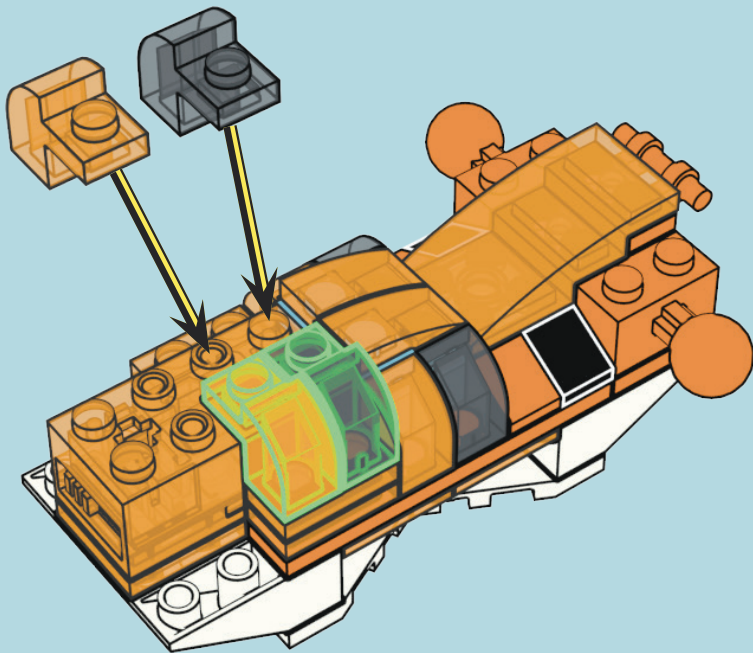

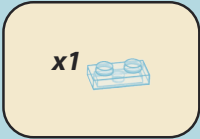

50 x2

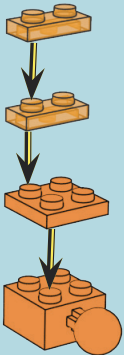

51

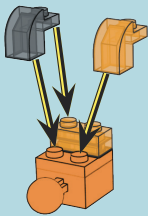
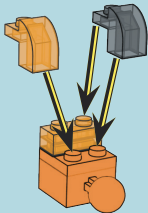

52

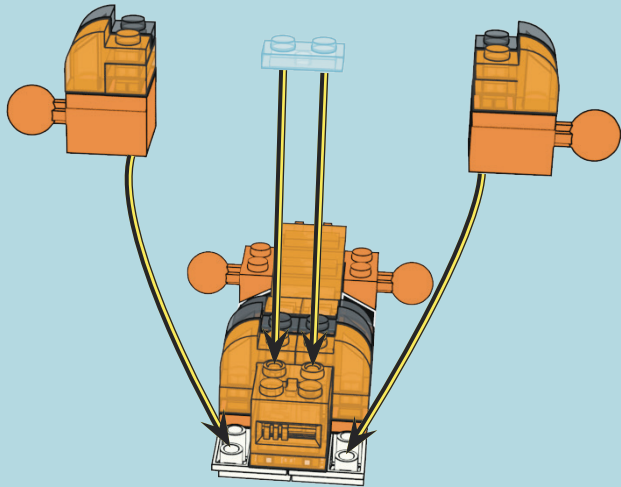

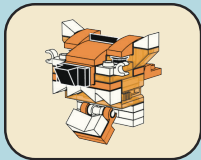

53

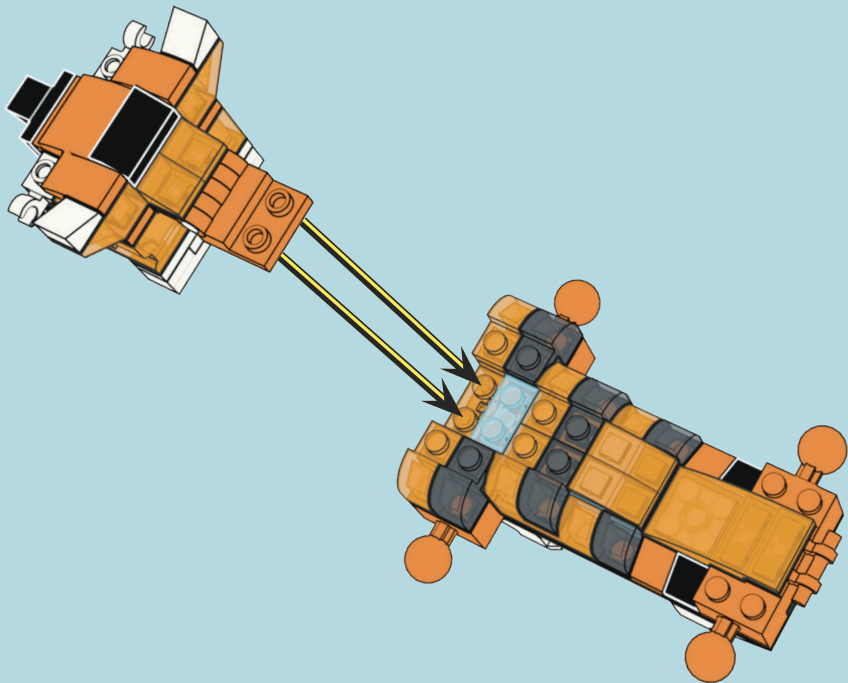

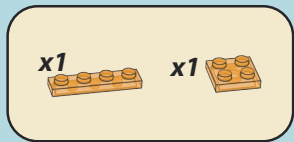

54

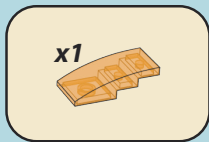
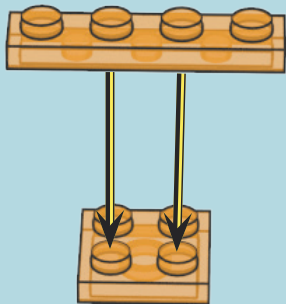

55

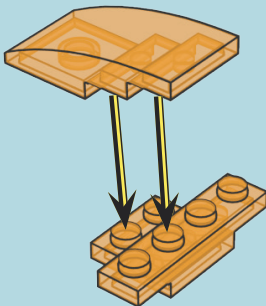

56

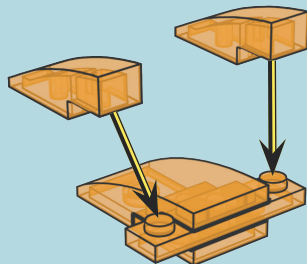

57

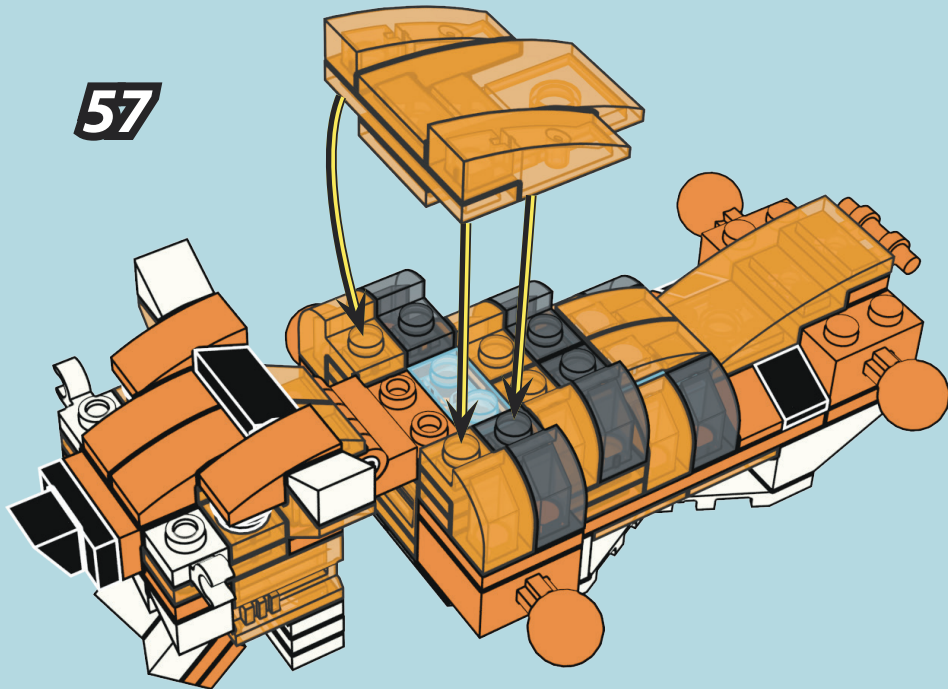

58

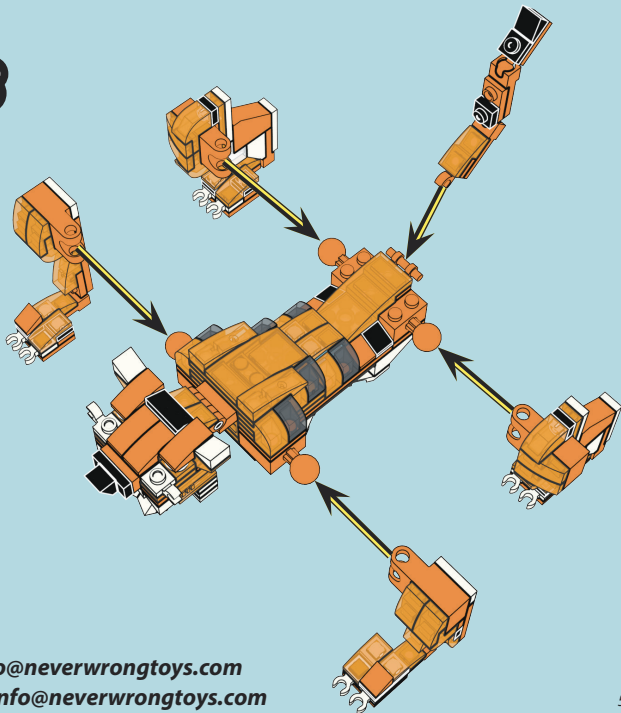
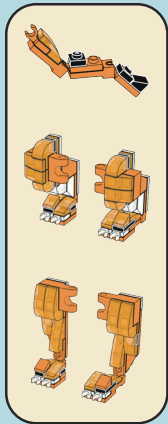

**Questions?? email: info@neverwrongtoys.com
Des questions?? Allez à: info@neverwrongtoys.com**

LASER PEGS

MULTI-MODELS

4 IN 1



FROG



PARROT



RED PANDA

4 WAYS TO BUILD!



TIGER

All additional model instructions can be viewed online at www.LaserPegs.com

Toutes les instructions supplémentaires du modèle peuvent être consultées en ligne sur www.LaserPegs.com

www.neverwrongtoys.com
Copyright 2021 © All Rights Reserved
U.S. Patent No. 8,864,546 & Other
Patents Pending.

NEVER WRONG

Toys & Games