

LASER PEGS

**MULTI-
MODELS**

5 IN 1

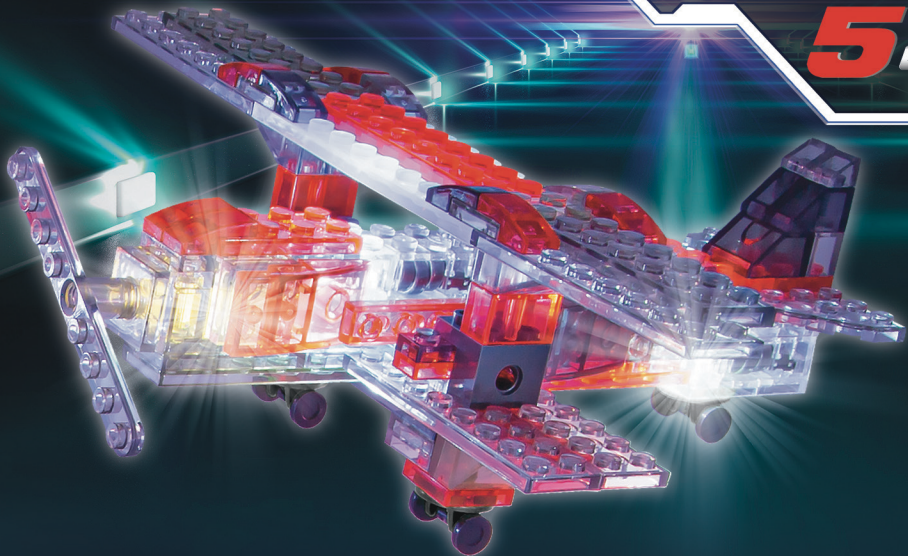

www.LaserPegs.com/52008/BIPLANE

x2
346-F44084

x8
40006-032C

x2
40008-032C

x1
10012-032C

x2
30012-032C

x2
10022-032C

x2
40002-032C

x2
10013-032C

x2
10014-032C

x5
10024-032C

x4
10016-032C

x6
10018-032C

x2
90003-401C

x2
328-G7124

x2
324-G7124

x3
LB101-Clear

x2
10016-Clear

x2
10110-Clear

x2
10028-Clear

x1
10048-Clear

x1
10410-Clear

x4
40006-4C

x2
40008-4C

x6
90008-4C

x2
40002-4C

x2
30014-4C

x8
40004-4C

x2
40005-4C

x2
80005-4C

x2
10003-4C

x2
90002-4C

x2
50002-Silver C

x2
10012-4C

x2
30012-4C

x10
10022-4C

x3
10023-4C

x1
10014-4C

x6
10024-4C

x7
10026-4C

x7
10028-4C

x3
70000-6C2X

x3
70011-6C2X

x2
40010-10C

x2
40003-10C

x2
40004-10C

x2
40005-10C

x4
40006-10C

x4
40012-10C

x1
40008-10C

x1
10212-Silver C

x2
80002-10C

x2
10010-10C

x2
10013-10C

x1
10014-10C

x1
30014-10C

x1
10024-10C

x6
10016-10C

x4
10016-6C2X

x1
10028-10C

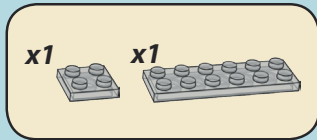
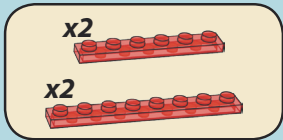

1

x2

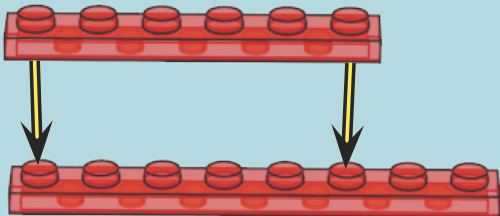

2

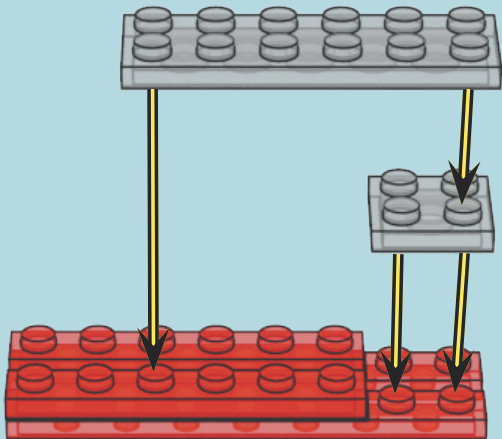

Scan for additional model instructions

BIPLANE *Rechercher des instructions supplémentaires sur le modèle*

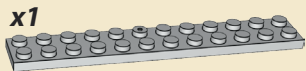
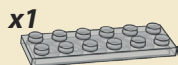

3

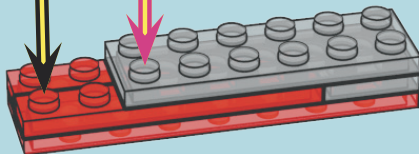
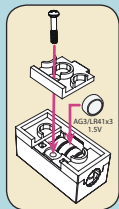
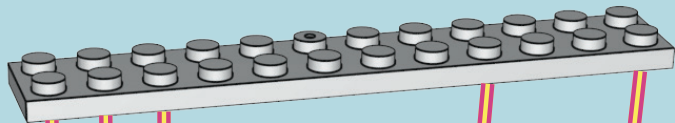
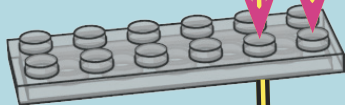

x2



4

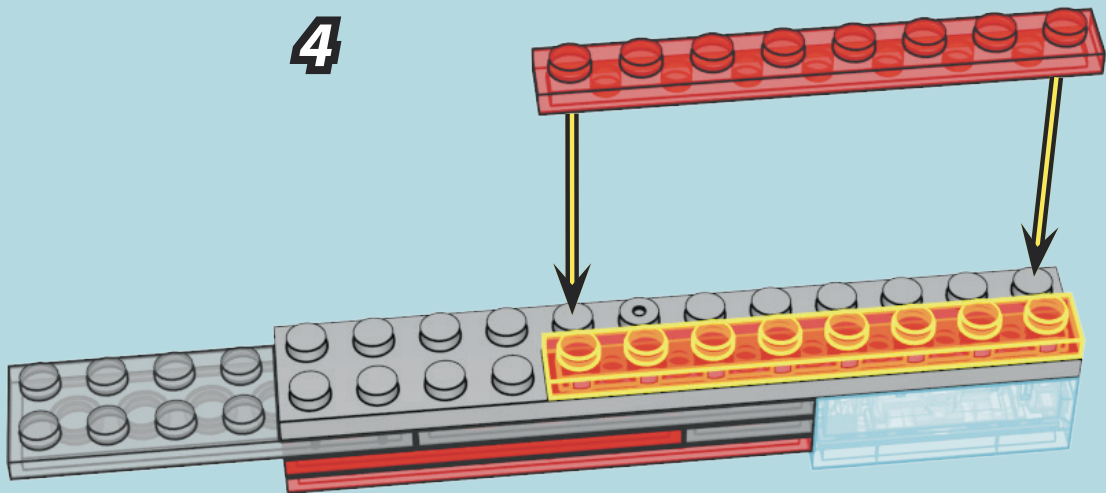

x1



x2



5

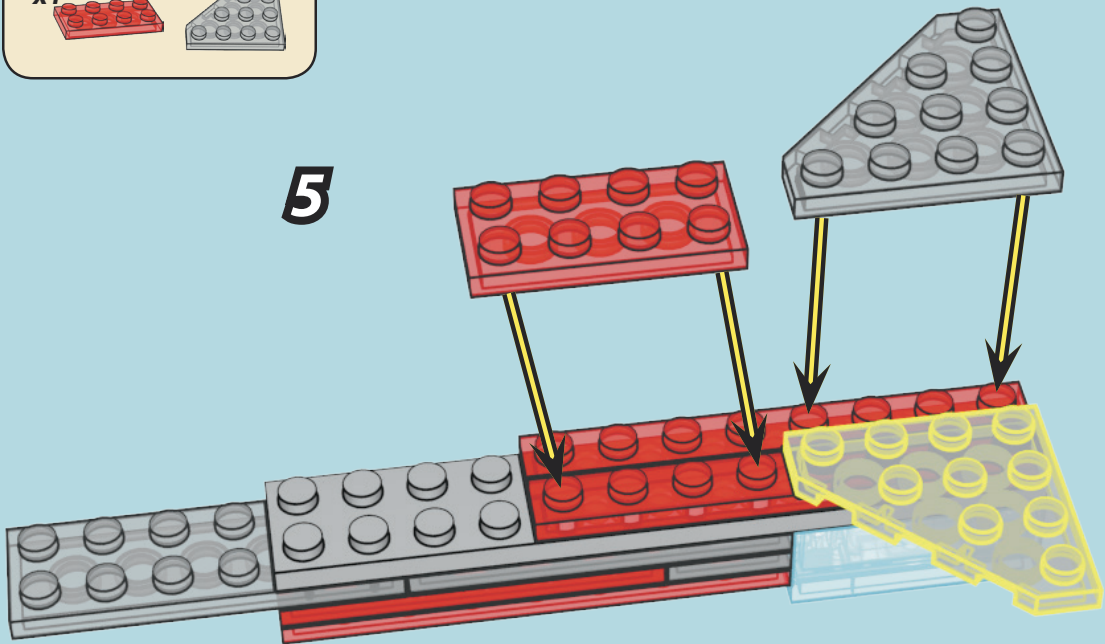

x1



x1



6

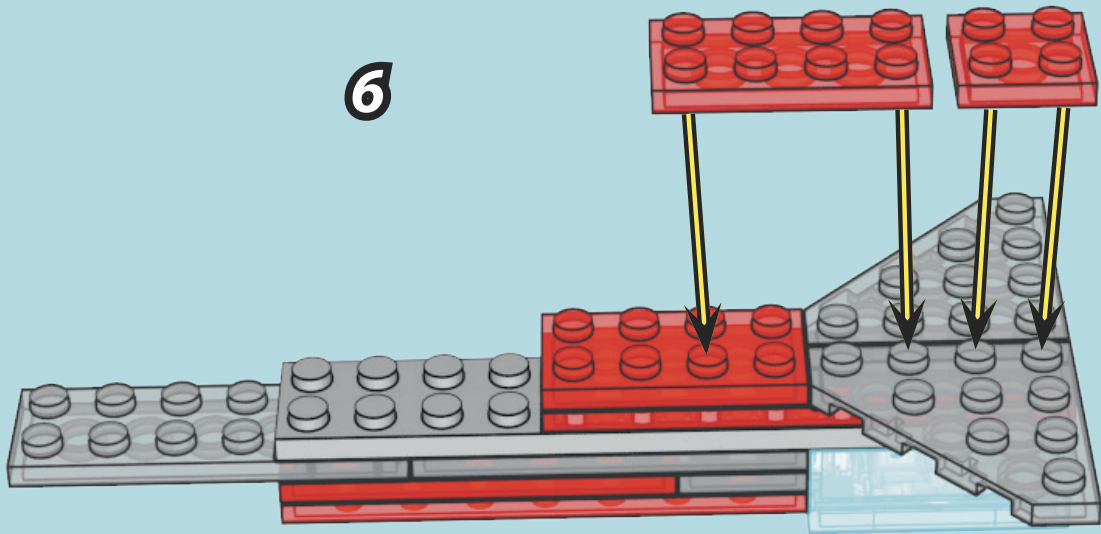

x2



7

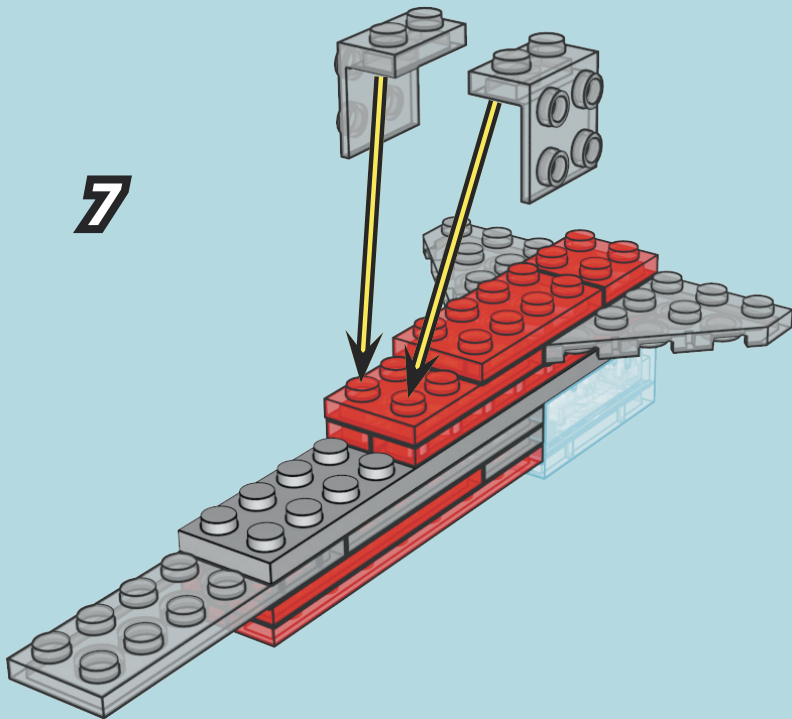

x1



x1



x1



8

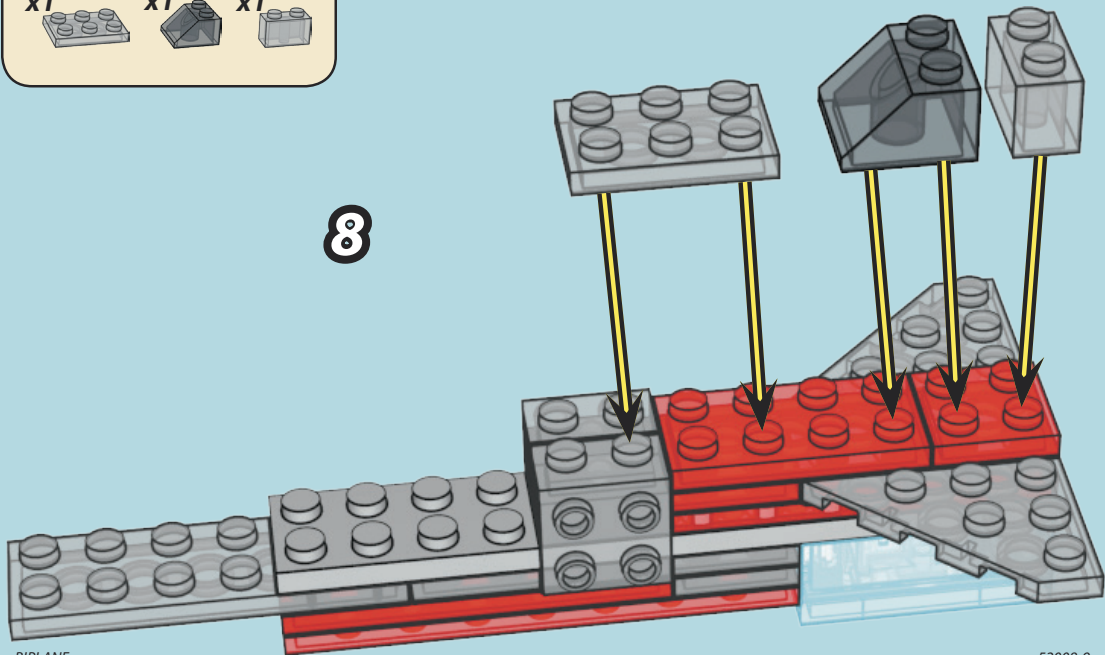

x2



x2



x1



9

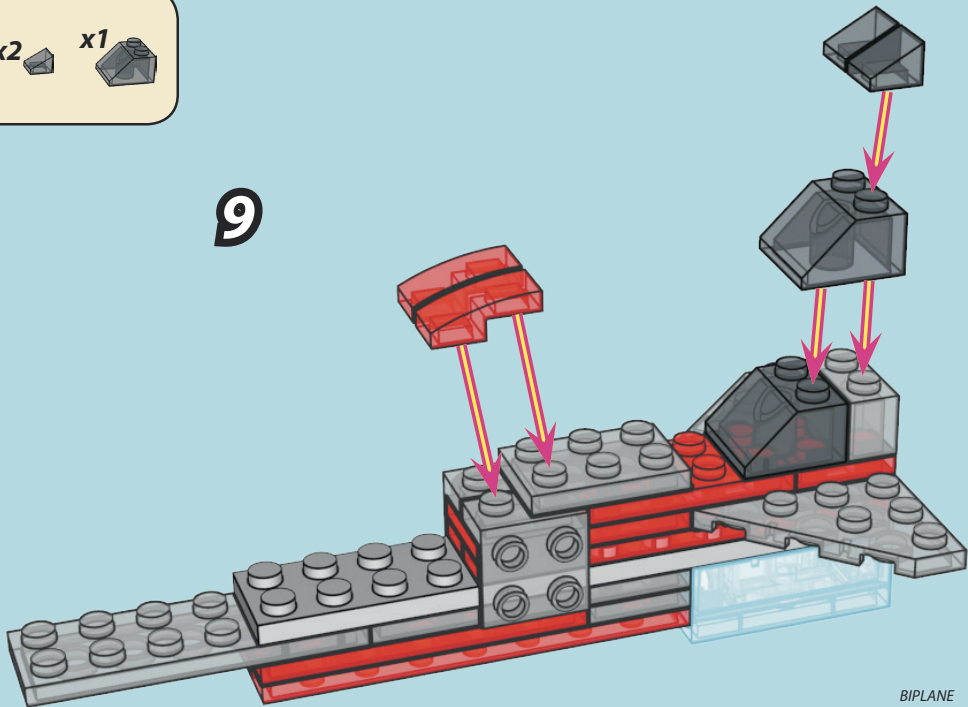

x1



x1



10

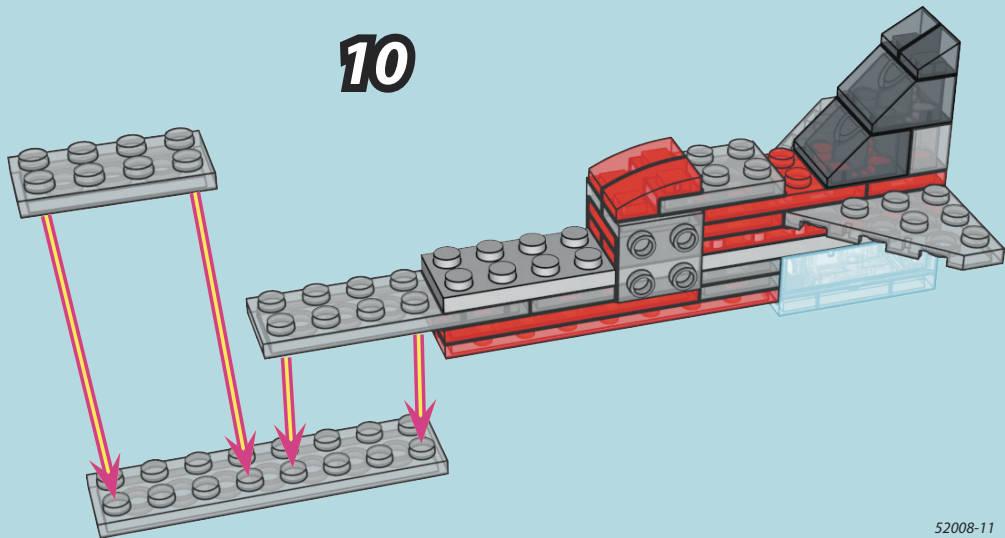

x1

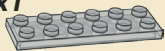

x1



11

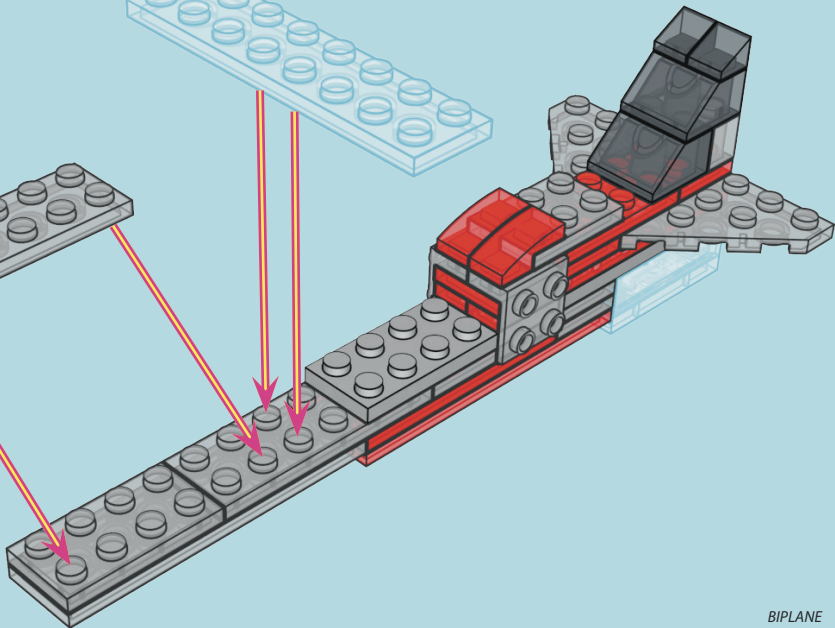
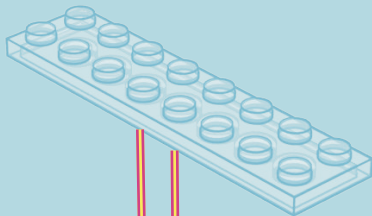
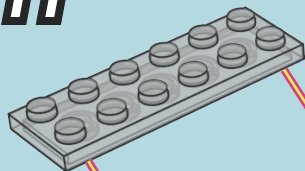

x1



x1



12

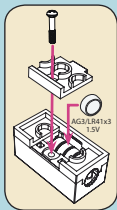
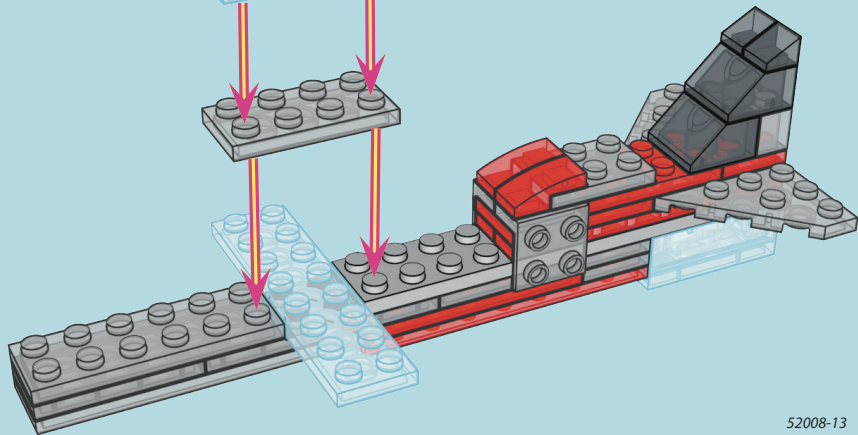
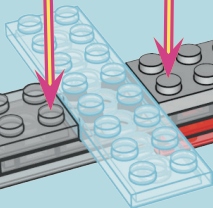
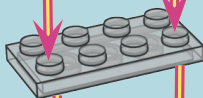

x1



x1



14

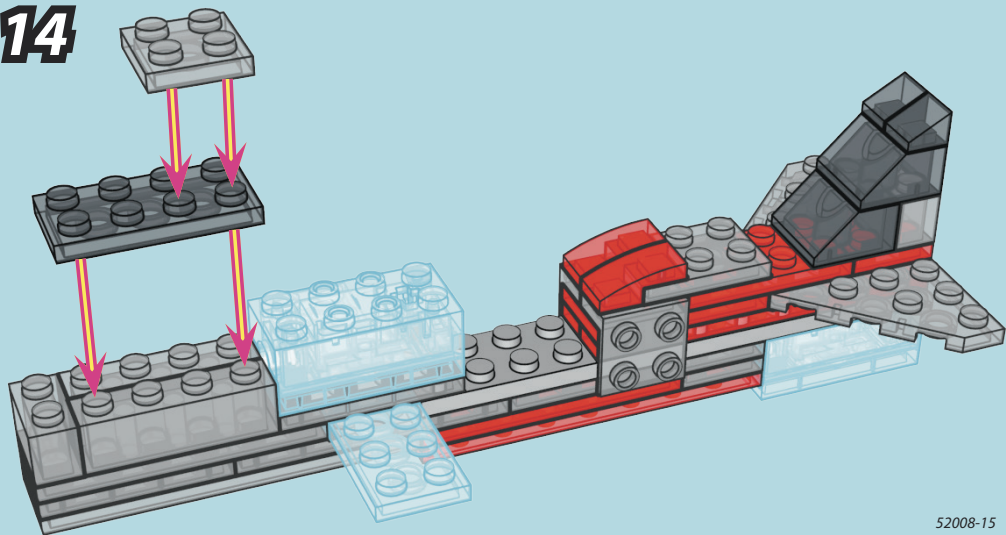

x3



15

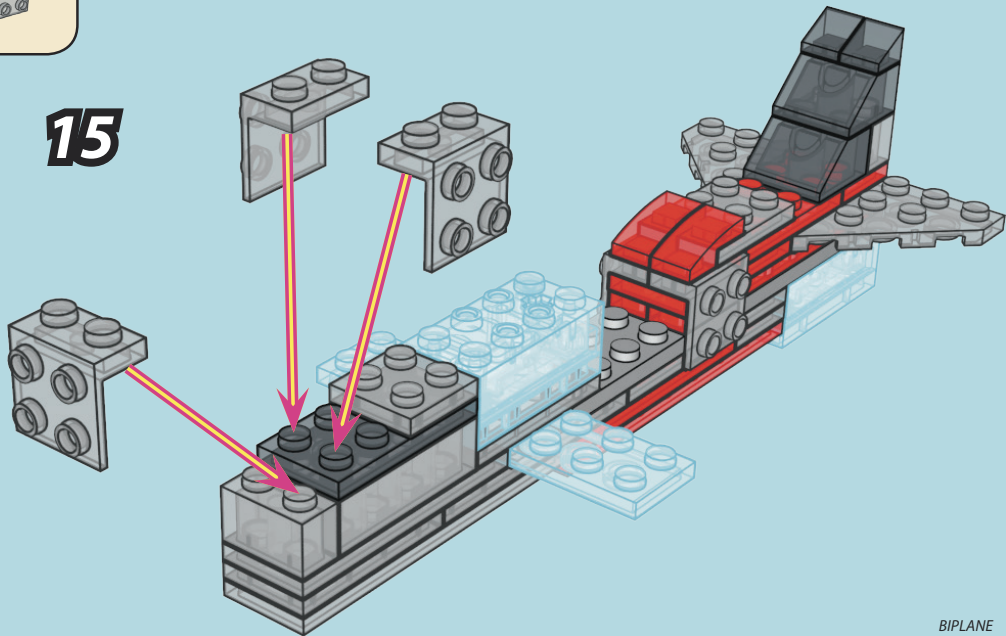

x2



17

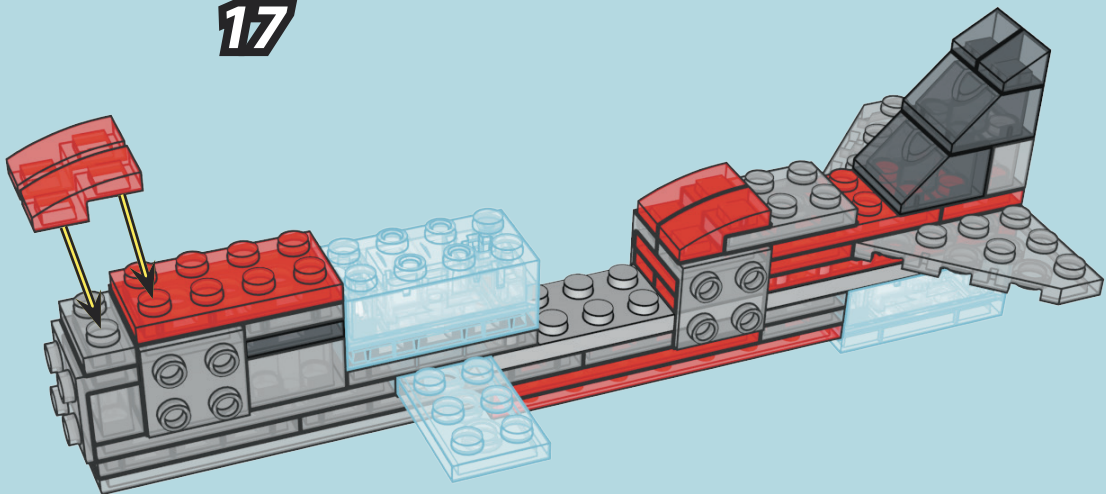

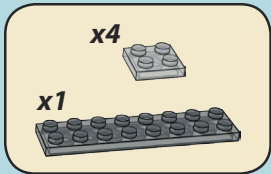

20

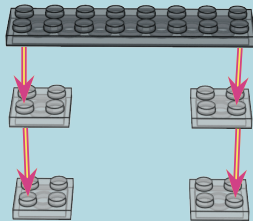

21

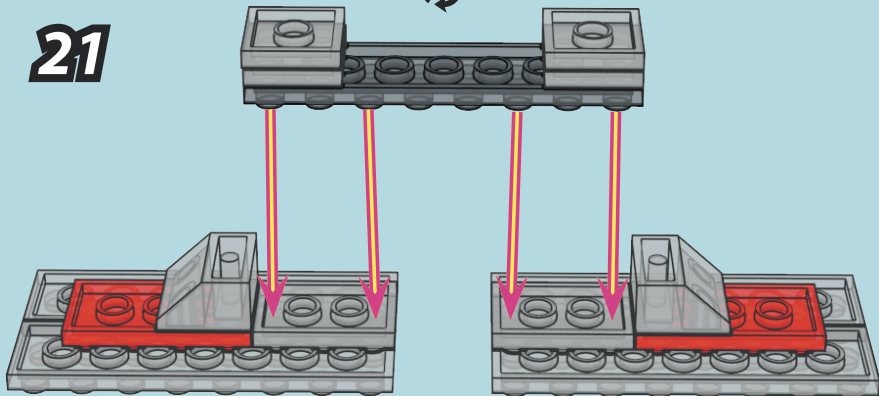

22

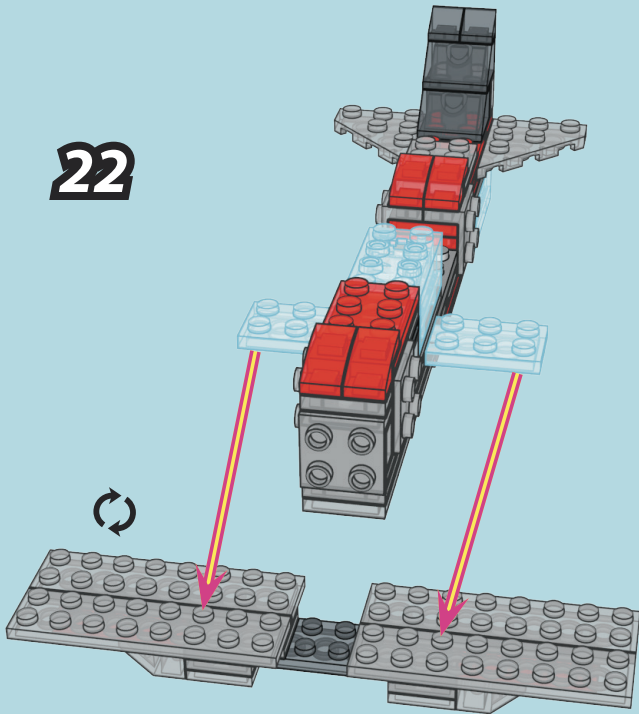

23

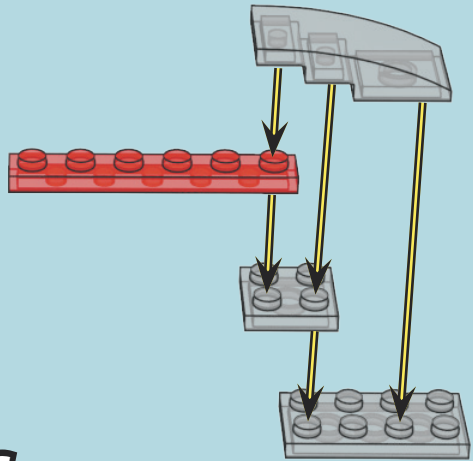
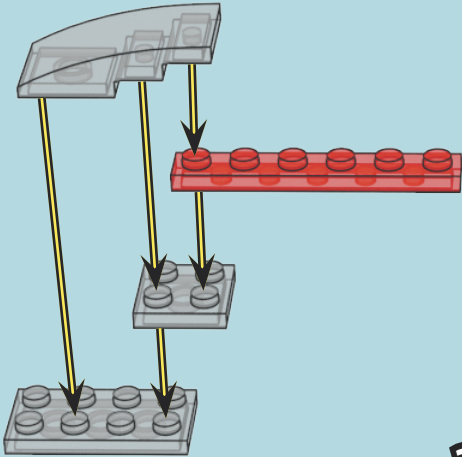
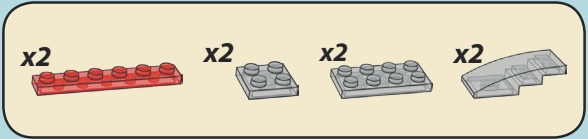

23a



x2



x2

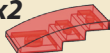

25

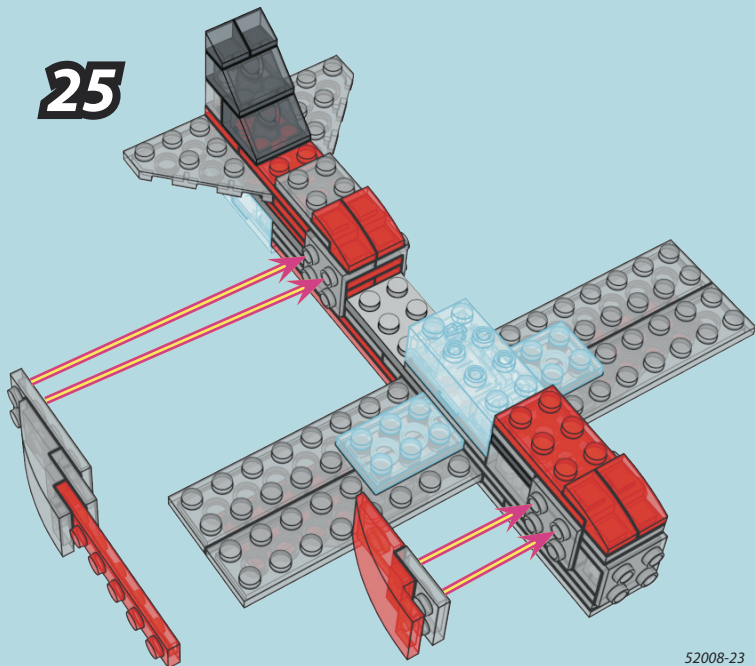

24

x2

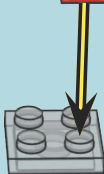
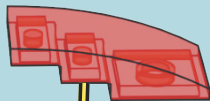

x1



x1



27

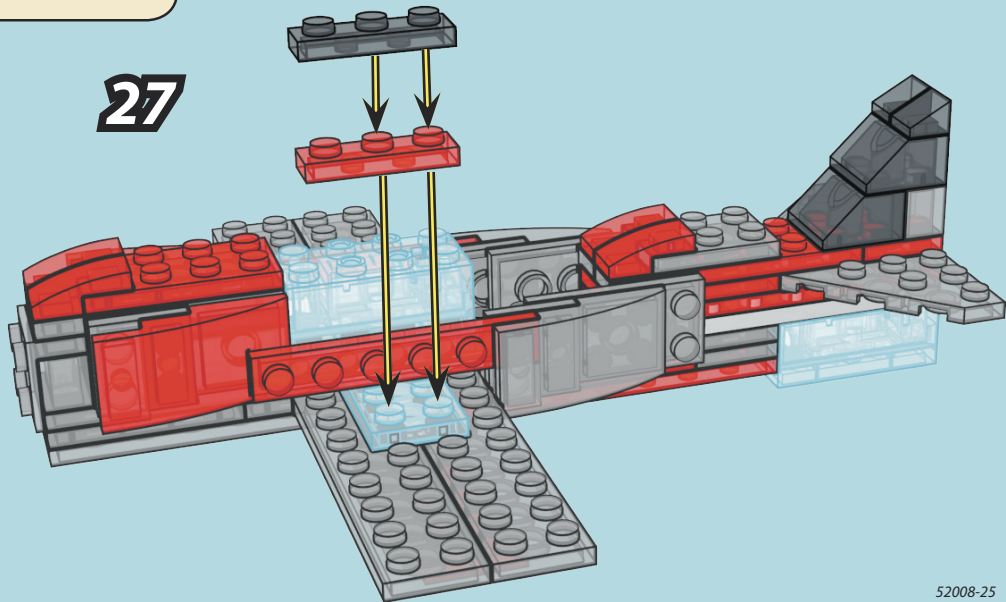

x1



x1



28

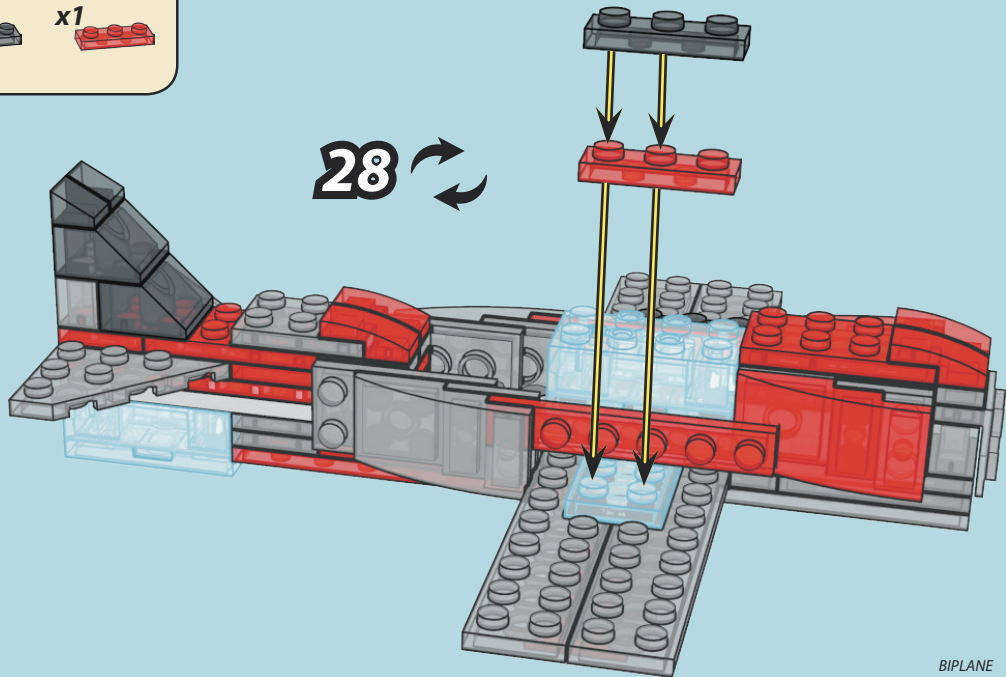

x2



29

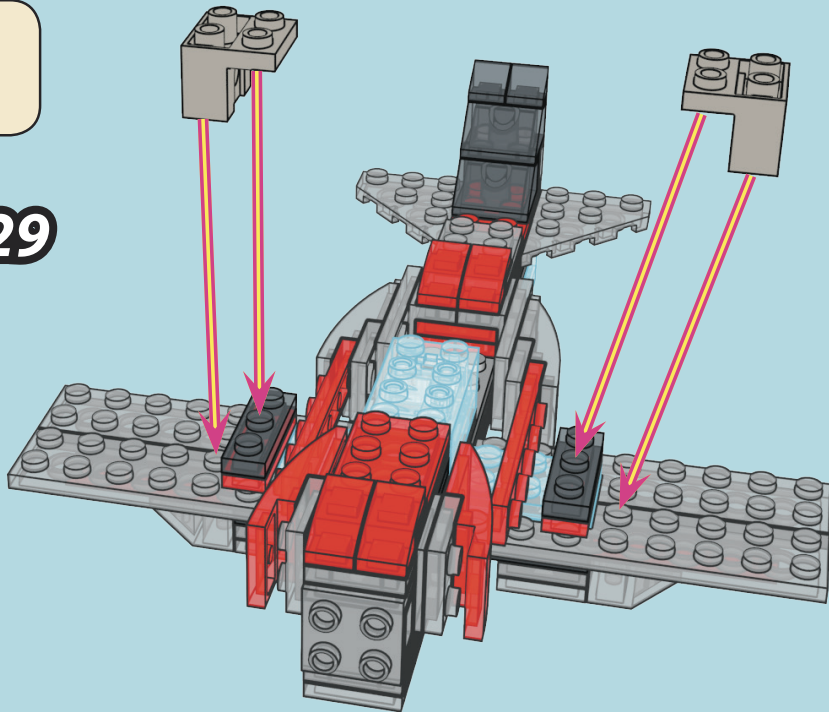

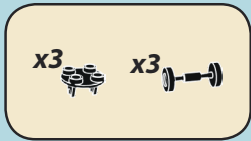

31

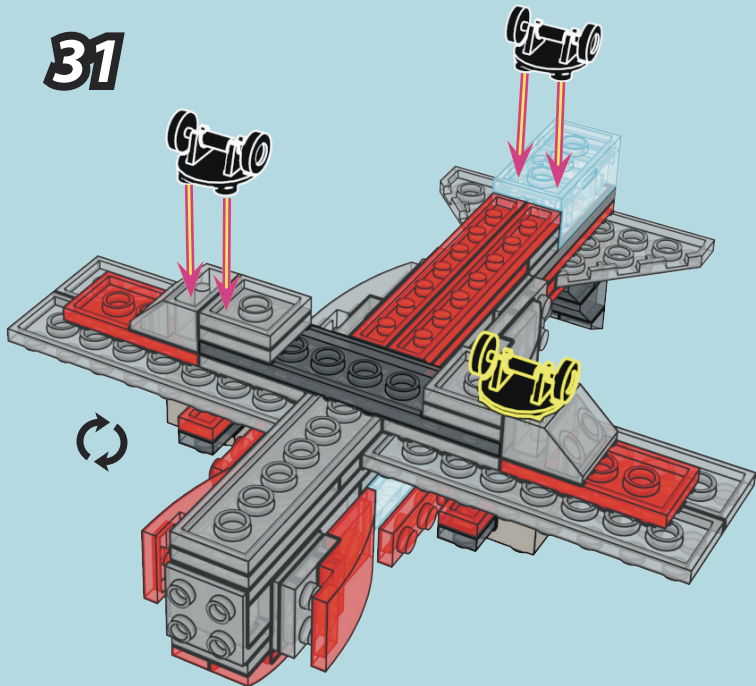

30

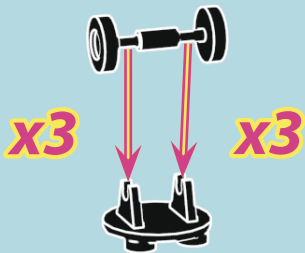

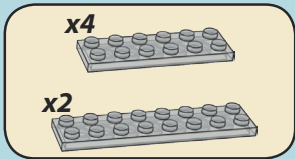

32

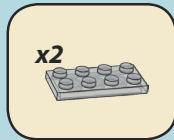
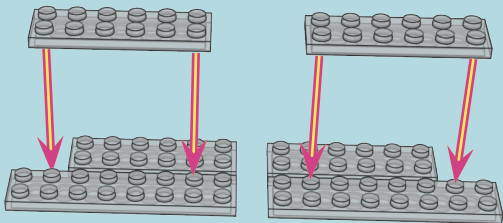

33

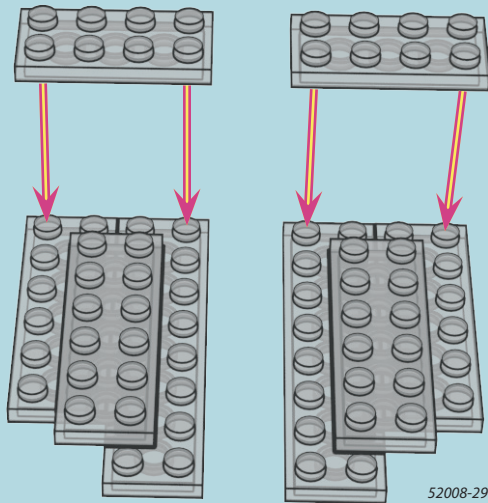

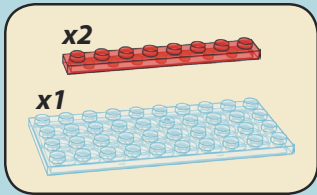

34

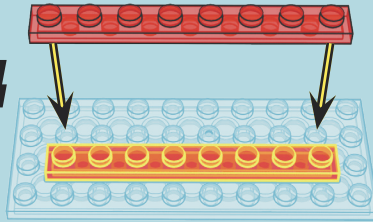

35

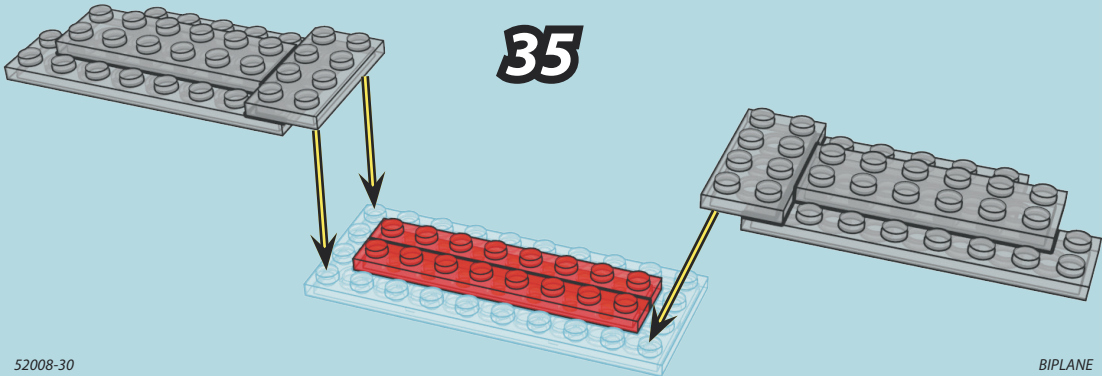

x4



x4



36

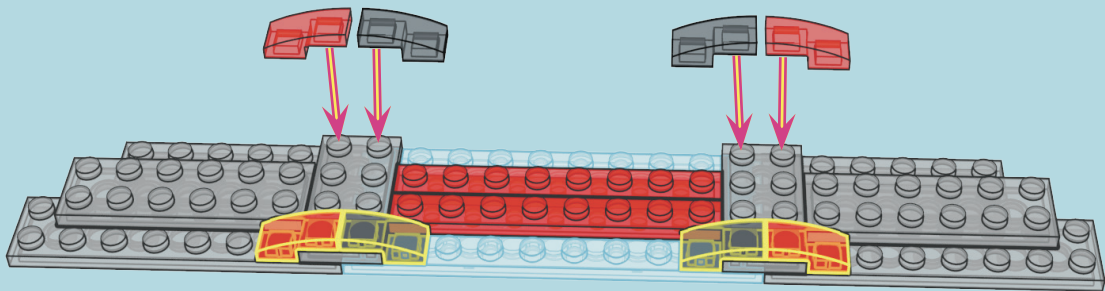

x2



x2



37

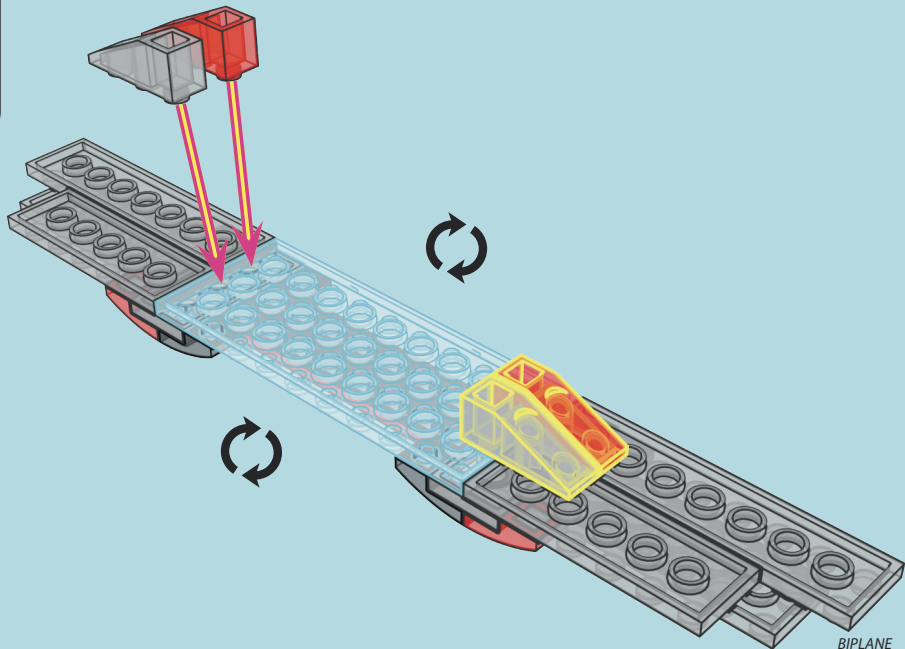

x2



38

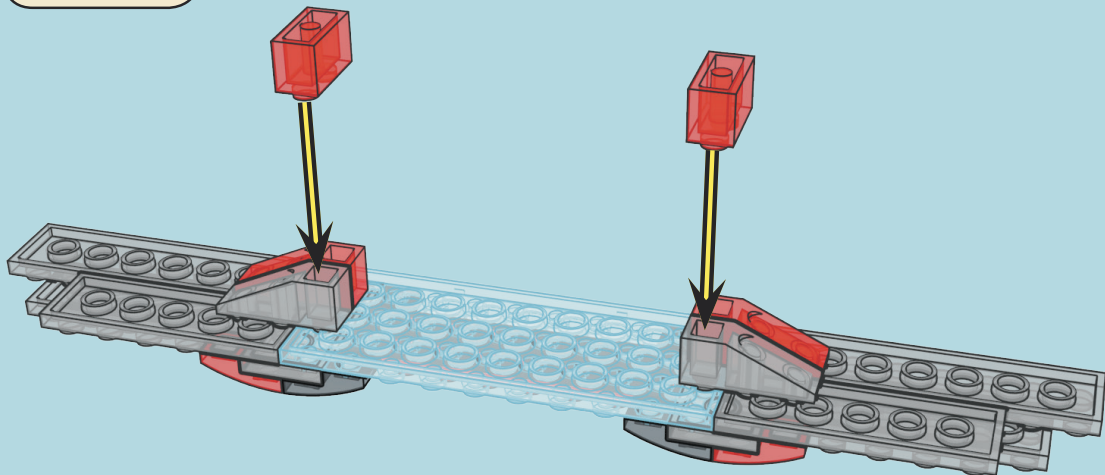

x1



x1



39

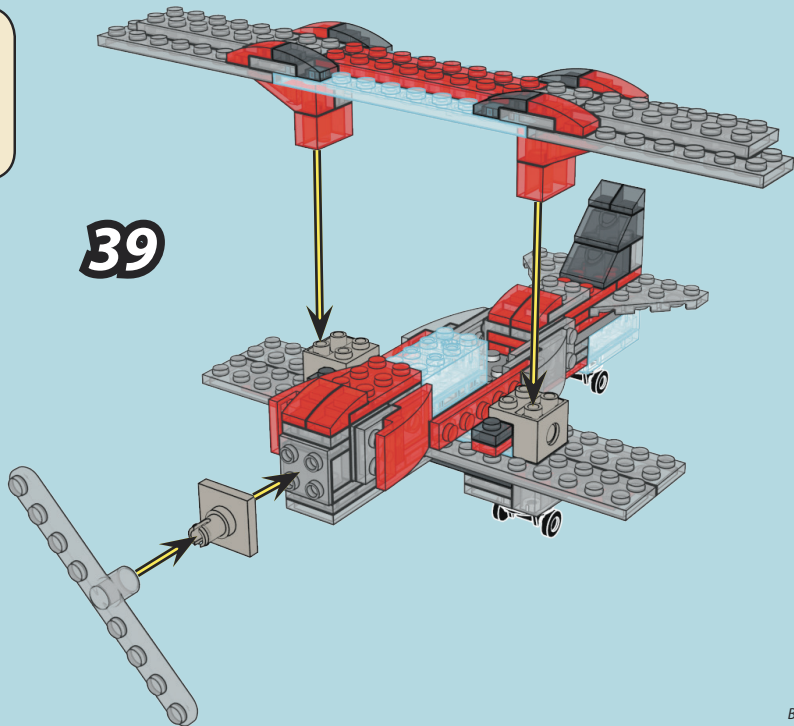

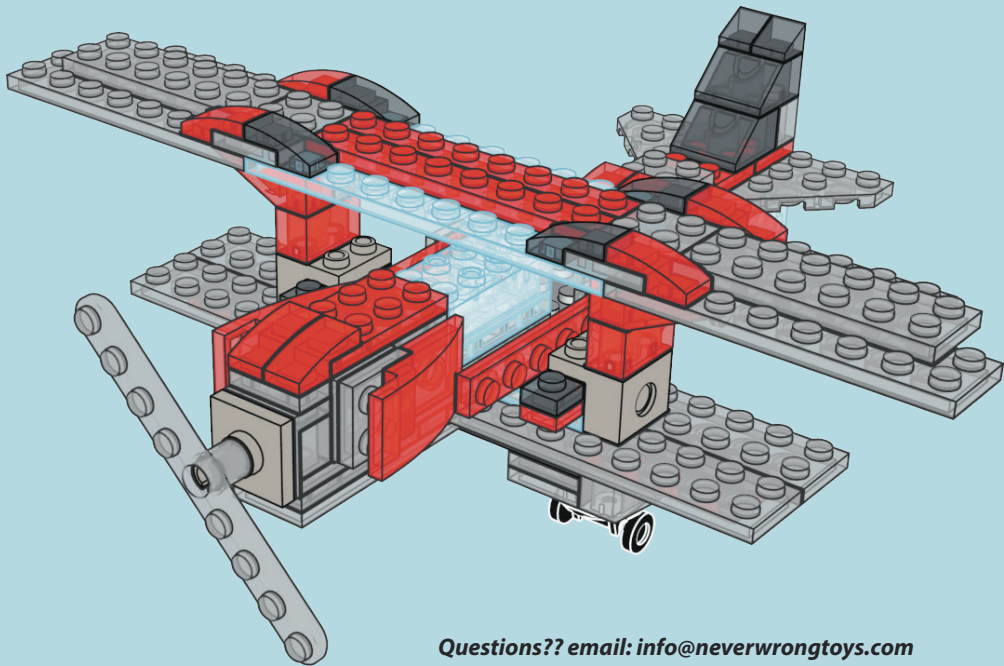

LASER PEGS

MULTI-MODELS
5 IN 1



**WARTHOG
PHACOCHÈRE**



CHINOOK



**BI-PLANE
BIPLAN**

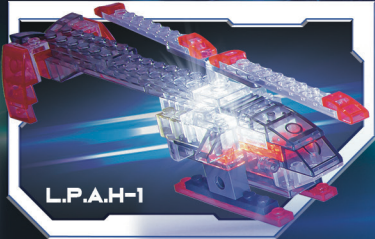

L.P.A.H-1

5 WAYS TO BUILD!
**5 OPTIONS
DECONSTRUCTION!**



**VTOL
SPARHAWK
ÉPERVIER**

www.neverwrongtoys.com
Copyright 2021 © All Rights Reserved
U.S. Patent No. 8,864,546 & Other Patents Pending.

All additional model instructions can be viewed online at www.LaserPegs.com
Toutes les instructions supplémentaires du modèle peuvent être consultées en ligne sur www.LaserPegs.com

**NEVER
WRONG**
Toys & Games