

LASER PEGS

Updated

**MULTI-
MODELS**

2 PACK
PAQUET DE



[www.LaserPegs.com/52006/HORNET & GRASSHOPPER](http://www.LaserPegs.com/52006/HORNET%20&%20GRASSHOPPER)

WARNING: CHOKING HAZARD-
Small parts. Not for children under 3 yrs.
Do not submerge in water.

ATTENTION: DANGER DE SUFFOCATION-
Petits éléments. Ne convient pas aux enfants de
moins de trois ans. Ne pas immerger le jeu dans l'eau.

x2 
157-84386

x6 
53-84386

x2 
50012-361C

x2 
10012-361C

x2 
10012-356C

x8 
60001-356C

x8 
60002-356C

x8 
60003-356C

x1 
71-84386

x14 
40006-361C

x2 
40007-361C

x2 
10022-361C

x1 
10023-361C

x2 
10014-361C

x1 
10024-361C

x2 
10016-361C

x2 
10026-361C

x2 
90008-361C

x1 
30022-361C

x2 
40002-361C

x1 
LB102-361C

x1 
10012-109C

x1 
10012-116C

x2 
60002-116C

x2 
71-18611

x2 
68-18611

x1 
10022-109C

x1 
79-18611

x1 
80-18611

x3 
10023-109C

x3 
10024-109C

x1 
10022-Clear

x3 
90024-PQ

x2 
157-18611

x2 
40011-109C

x4 
40009-109C

x1 
30012-109C

x1 
40008-109C

x1 
LB103-109C

x4 
50000-6C2X

x4 
826-K2048

x2 
53-K2048

x10 
40006-6C2X

x4 
60000-6C2X

x2 
60001-6C2X

x2 
60003-6C2X

x2 
10014-6C2X

x4 
10016-6C2X

x2 
10010-10C

x6 
40006-10C

x2 
40003-10C

x6 
40009-10C

x1 
90008-10C

x1 
10022-10C

x1 
10023-10C

x2 
10003-10C

x1 
10001-10C

x1 
10002-10C

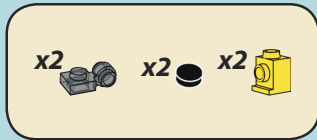
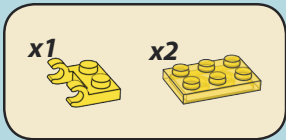
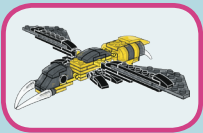

1

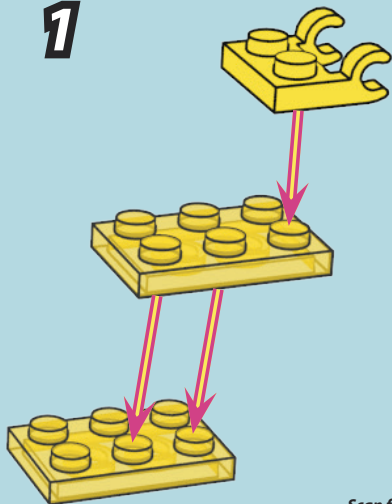

2

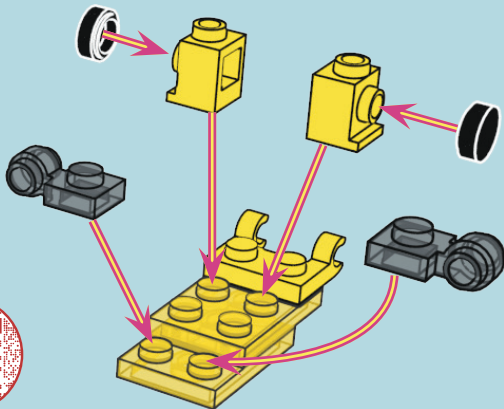

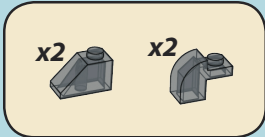

3

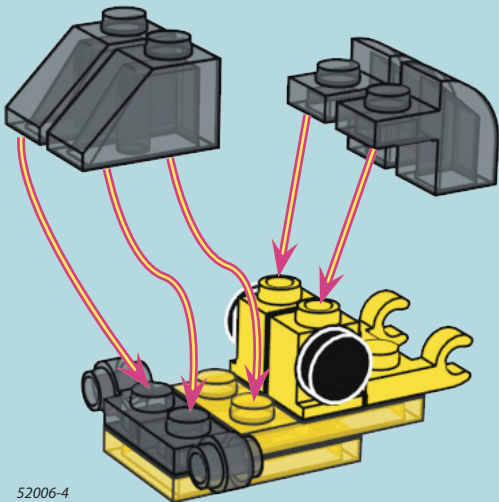

52006-4

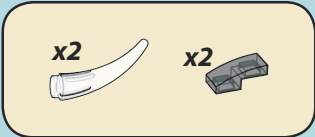

4

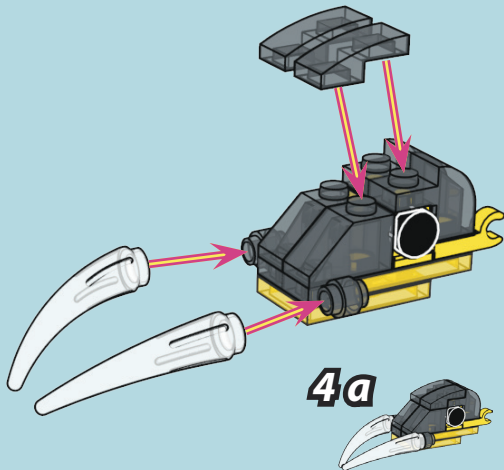

4a

HORNET & GRASSHOPPER

5

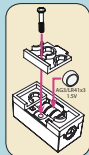
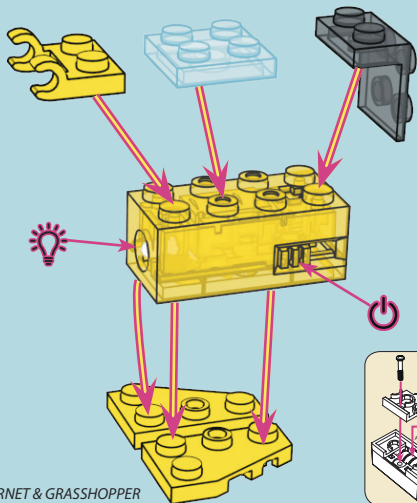
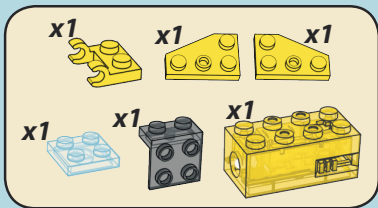

HORNET & GRASSHOPPER

6

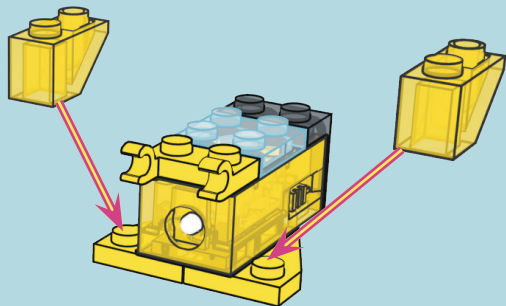

52006-5

x4



x4



x1



x1



x1



7

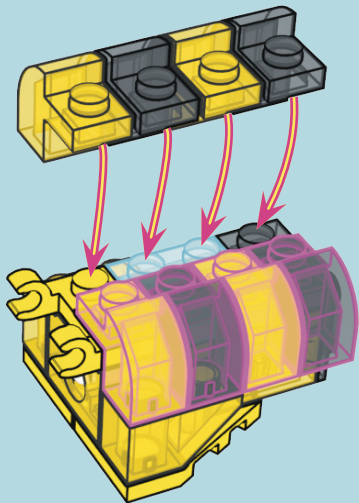

8

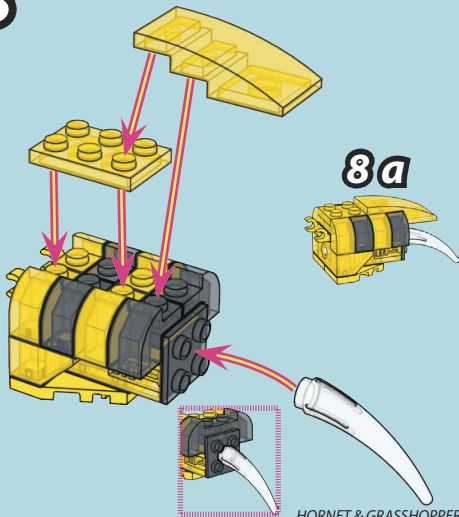

8a

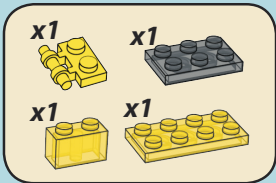

9

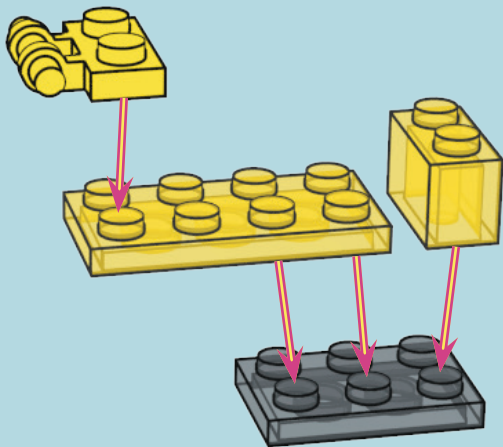

HORNET & GRASSHOPPER

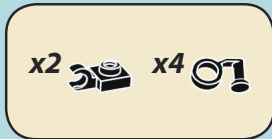

10

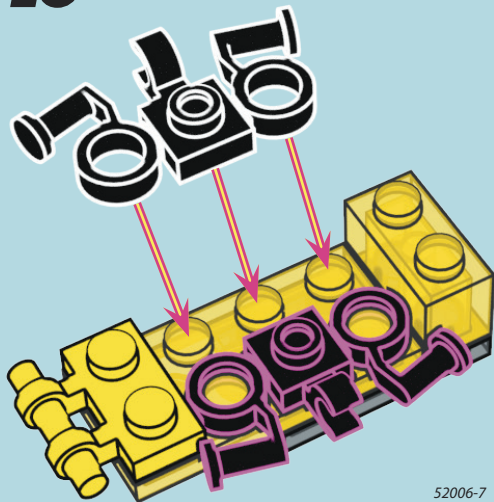

52006-7

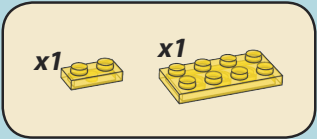
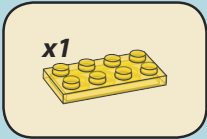

11

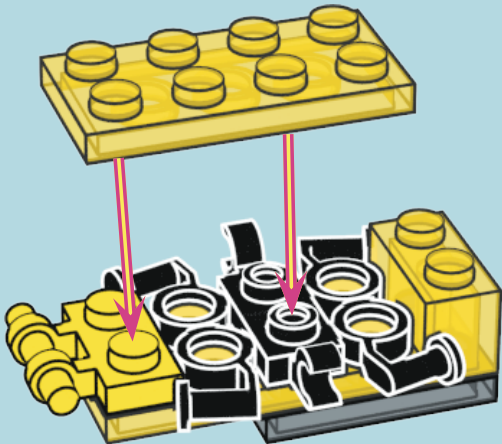

12

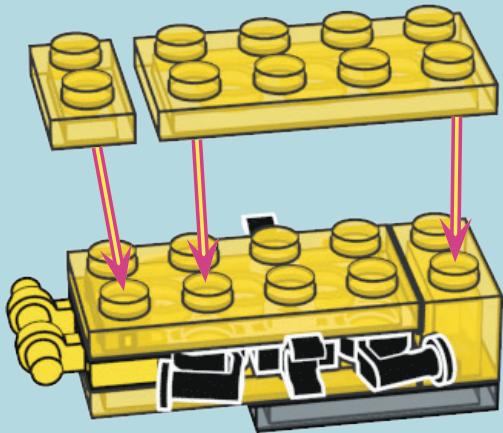

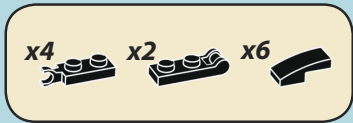

13

x4

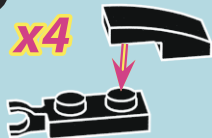

14

x2

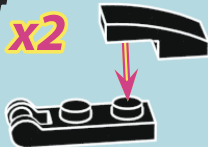

15

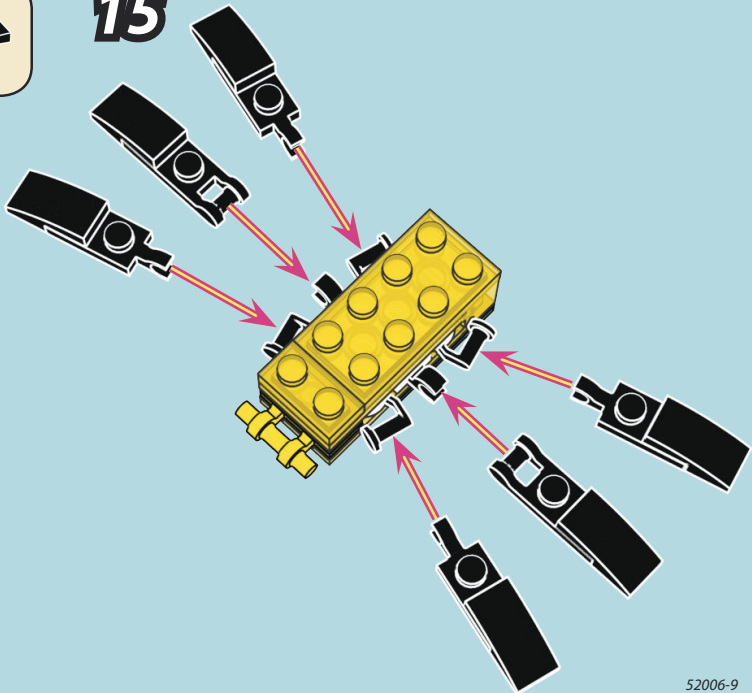

x2



16

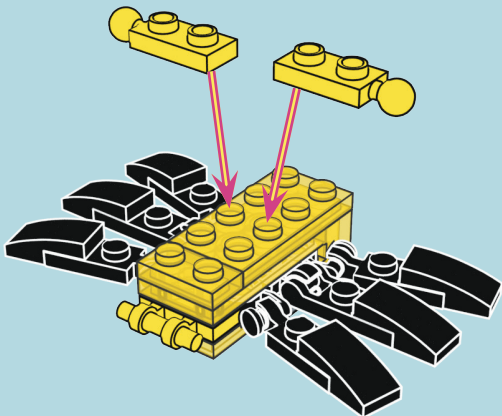

x1



x1



x1



17

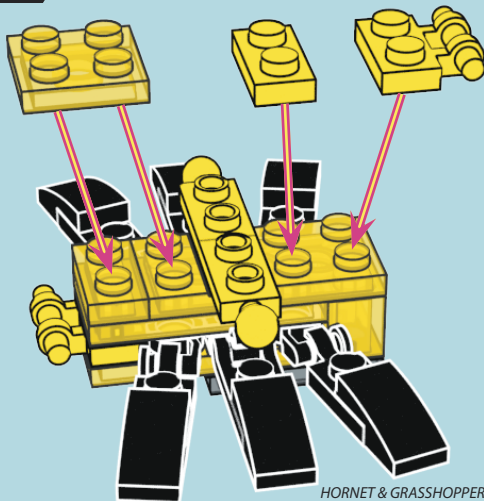

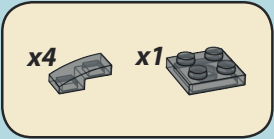

18

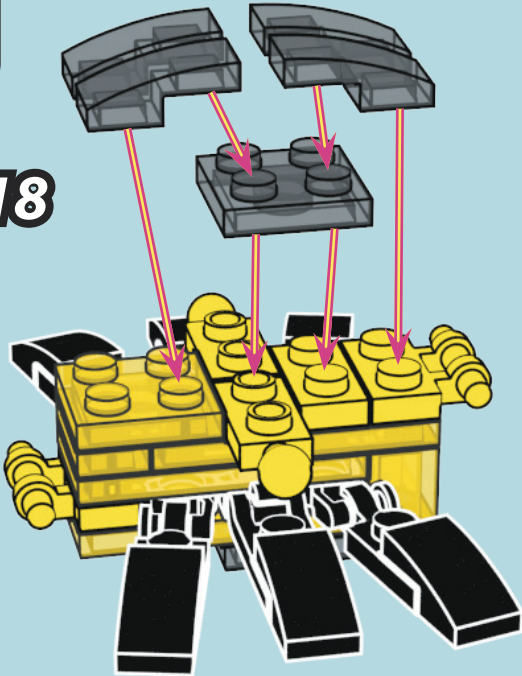

18a

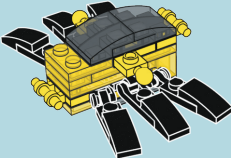

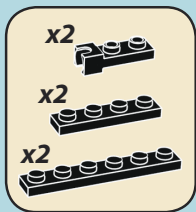

19

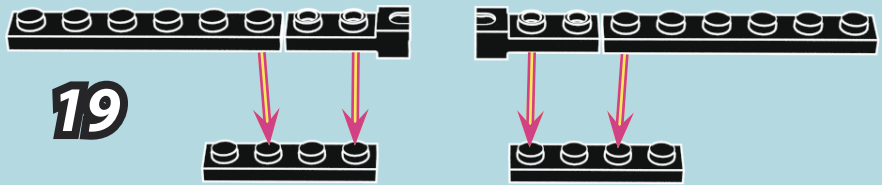

20

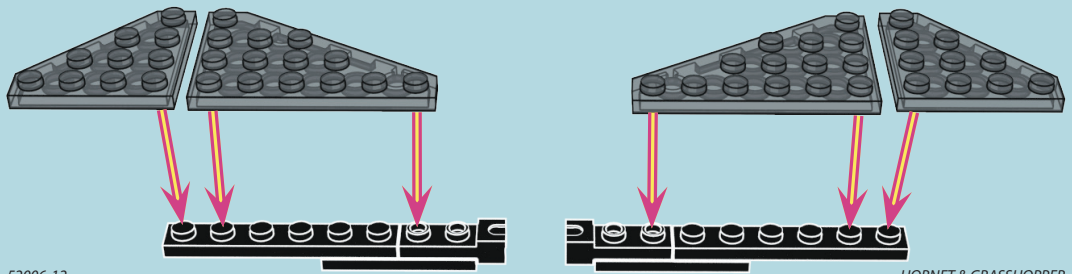
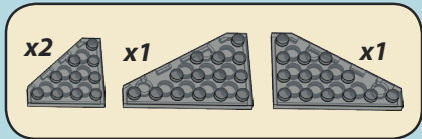

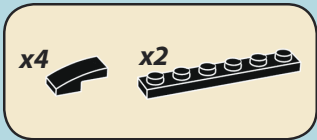

21

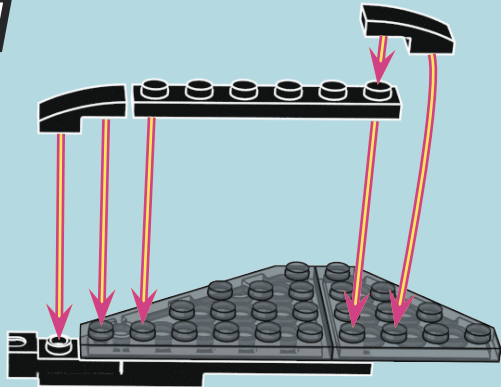
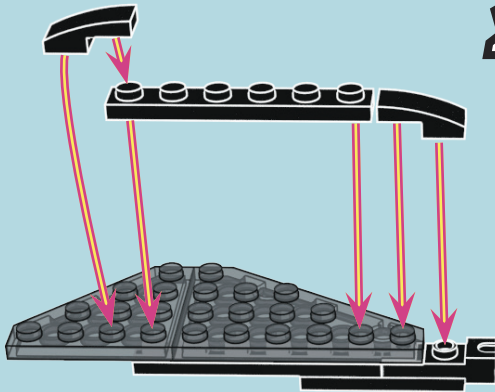

21a

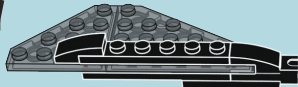

22

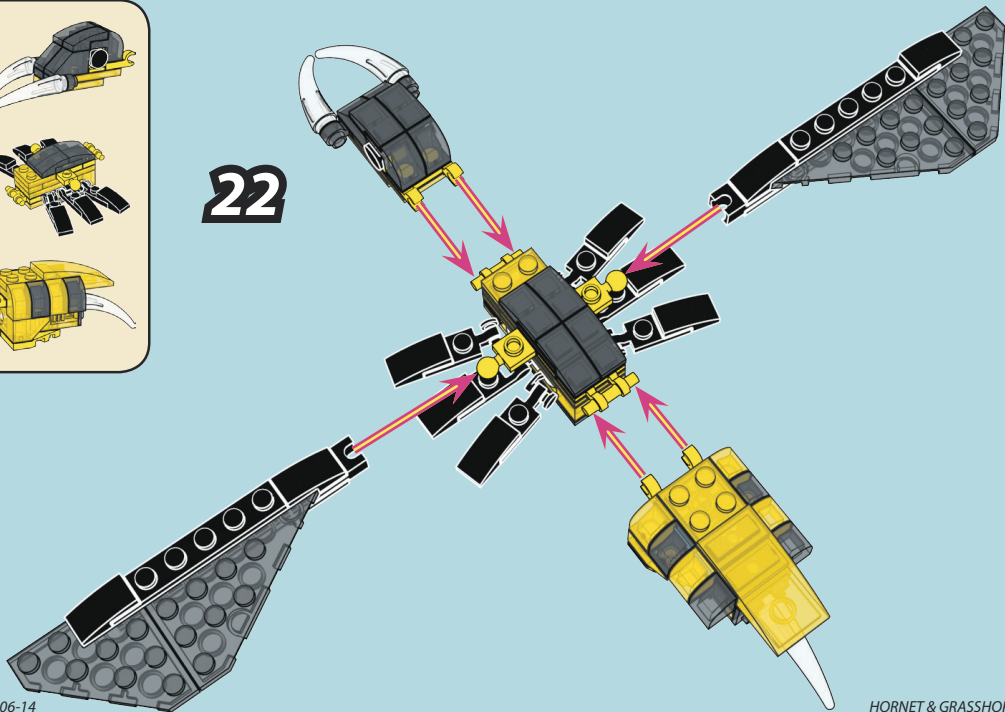
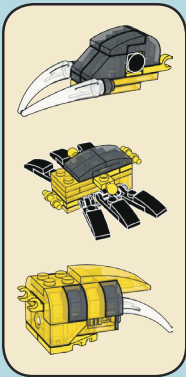

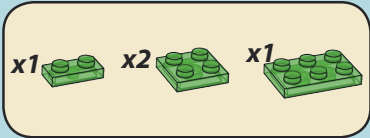
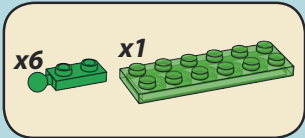
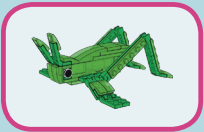

1

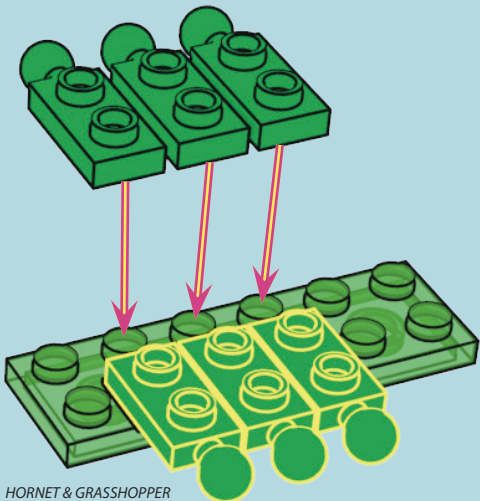

2

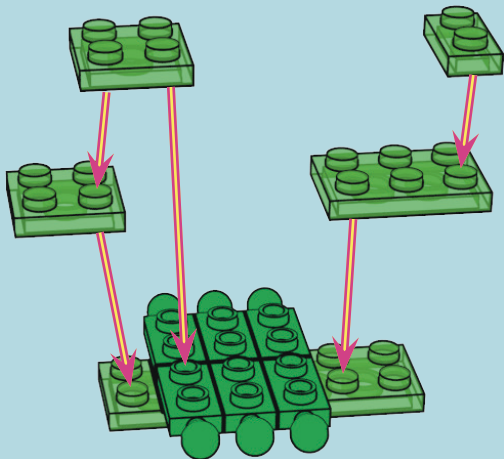

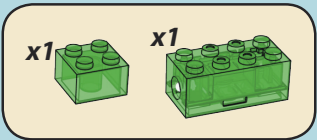

3

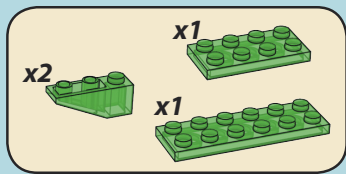
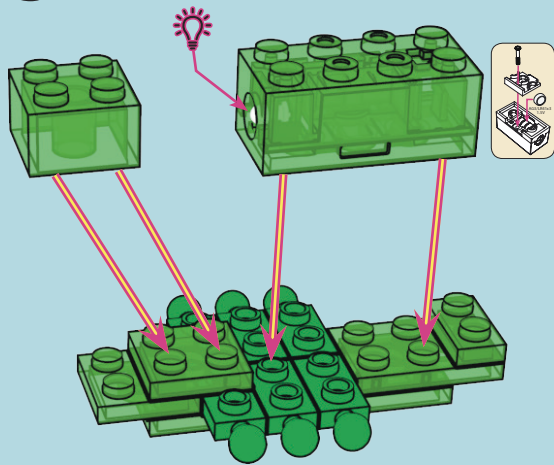

4

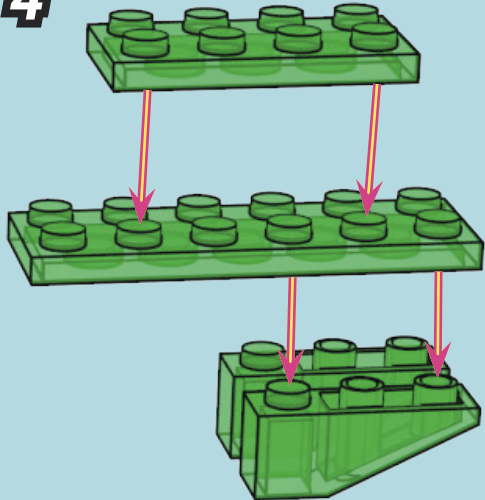

5

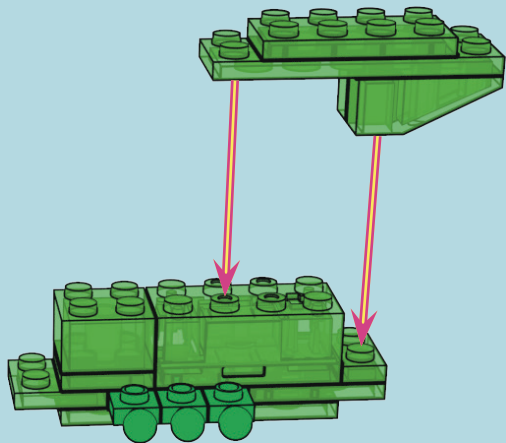

HORNET & GRASSHOPPER



6

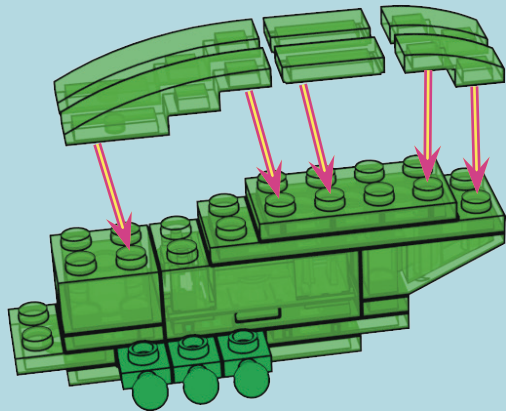

52006-17

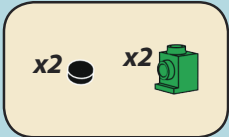

7

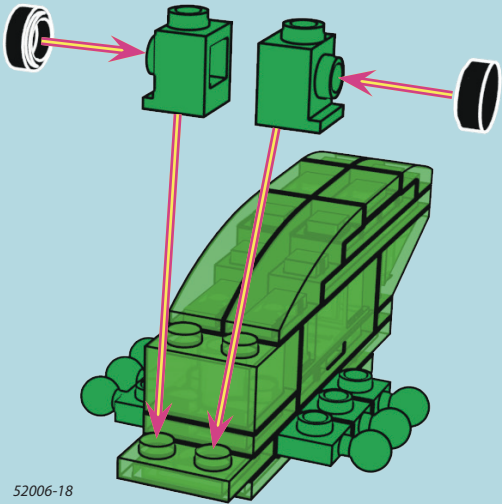

8

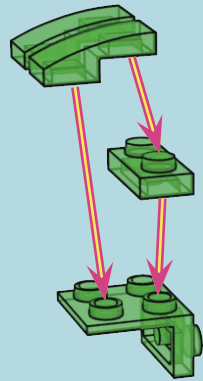

9

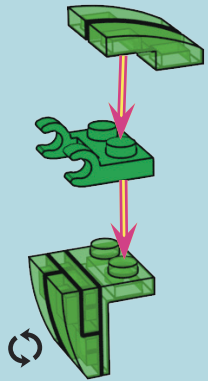

10

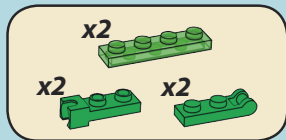
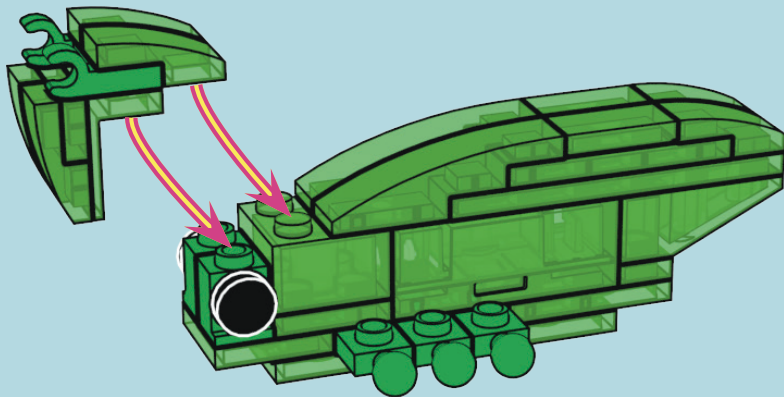

11

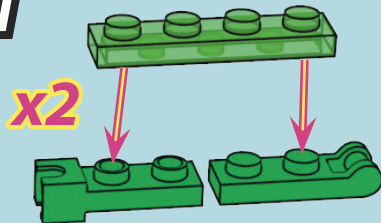

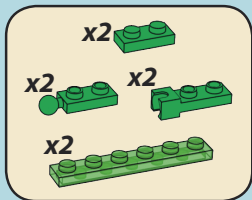

12

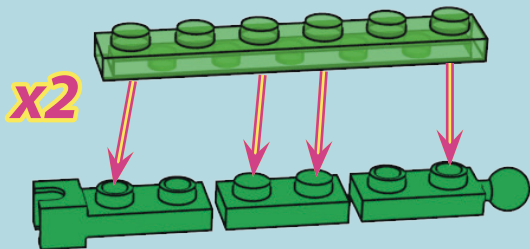

13

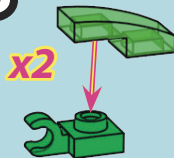

14a

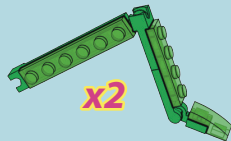

14

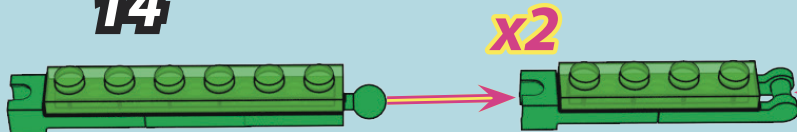

x4



x4



x4



x4



x2



x2



15

x4

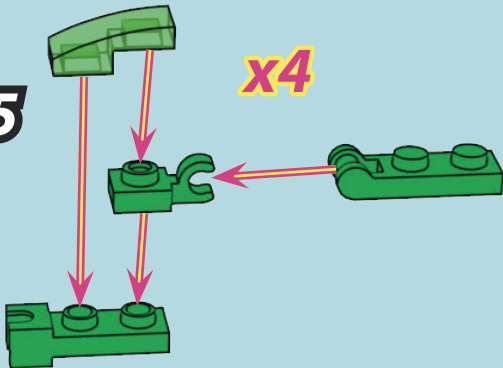

16

x2

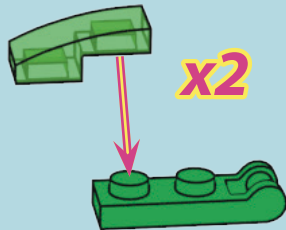

15a

x4



16a

x2



x2



x4



x2

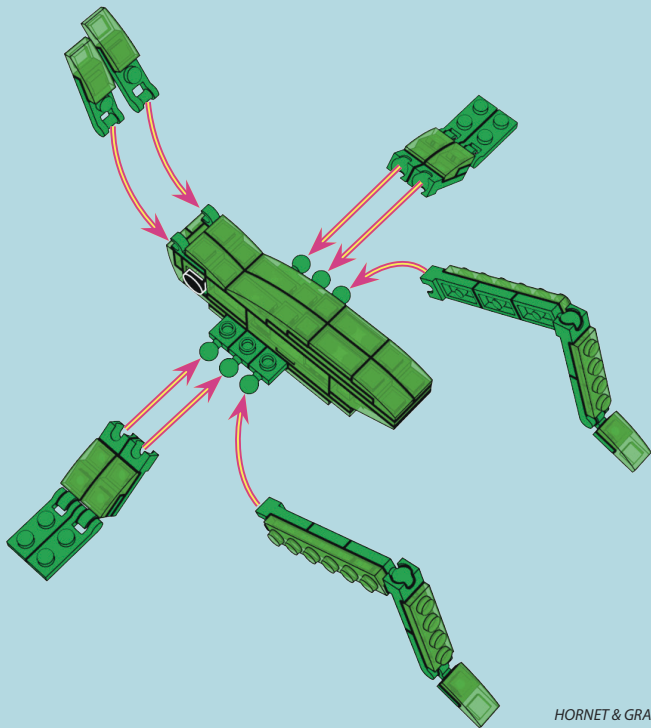
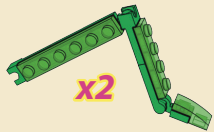

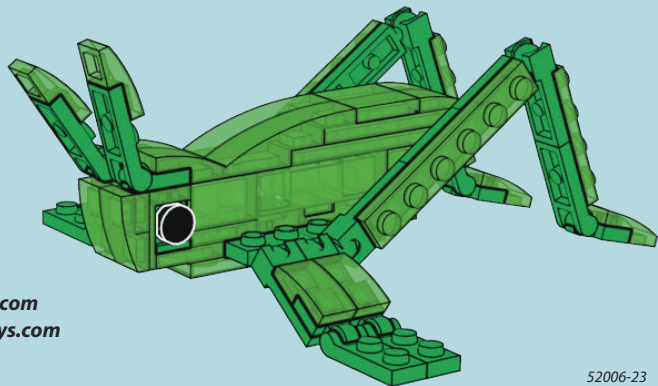
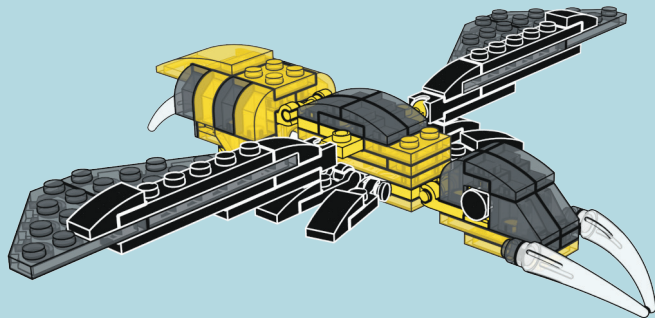

**Questions?? email: info@neverwrongtoys.com
Des questions?? Allez à: info@neverwrongtoys.com**

LASER PEGS

**MULTI-
MODELS**

2 PACK
PAQUET DE

+

GRASSHOPPER
SAUTERELLE



HORNET
FRELON



www.neverwrongtoys.com

Copyright 2021 © All Rights Reserved

U.S. Patent No. 8,864,546 & Other Patents Pending.

**NEVER
WRONG**
Toys & Games