

**LASER PEGS**

**MULTI-  
MODELS**

**4 IN  
EN 1**



[www.LaserPegs.com/52005/TRAINER](http://www.LaserPegs.com/52005/TRAINER)

x4   
40010-299C

x1   
308-F44084

x1   
80008-New Gold

x4   
50012-Silver C

x1   
476-PMG441

x2   
50016-Silver C

x1   
50001-Silver C

x1   
806-PMG441

x1   
79-PMG441

x1   
80-PMG441

x2   
10012-4C

x3   
10014-4C

x3   
10024-4C

x1   
10026-4C

x2   
10210-4C

x2   
10011-PQ

x1   
10012-PQ

x2   
10013-PQ

x1   
10016-PQ

x1   
10022-PQ

x2   
10023-PQ

x1   
10024-PQ

x2   
10003-PQ

x1   
10001-PQ

x1   
10002-PQ

x1   
10210-PQ

x2   
40010-PQ

x6   
40006-PQ

x2   
40008-PQ

x2   
80002-PQ

x2   
40003-PQ

x2   
30014-PQ

x2   
30016-PQ

x2   
826-C9121

x2   
52-C9121

x2   
68-C9121

x1   
10023-TPG

x1   
234-C9121

x1   
235-C9121

x1   
10012-1645C

x4   
10005-1645C

x2   
30016-1645C

x1   
LB100-10C

x1   
LB101-10C

x1   
10012-Clear

x1   
10024-Clear

x2   
90031-Clear

x2   
30014-Clear

x2   
90027-Clear

x1   
90036-Clear

x1   
90035-TPG

x2   
40003-10C

x2   
40011-6C2X

x4   
40005-6C2X

x2   
44-K2048

x2   
72-K2048

x1   
303-K2048

x2   
80004-6C2X

x4   
10026-6C2X

x1   
705-K2048

x1   
272-K2048

x1   
273-K2048

x2   
10001-6C2X

x2   
10002-6C2X

x1   
10410-6C2X

x1   
90037-K2048

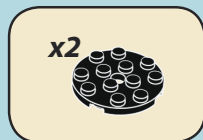
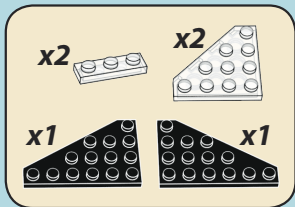

Scan for additional model instructions  
Rechercher des instructions supplémentaires sur le modèle

**1**

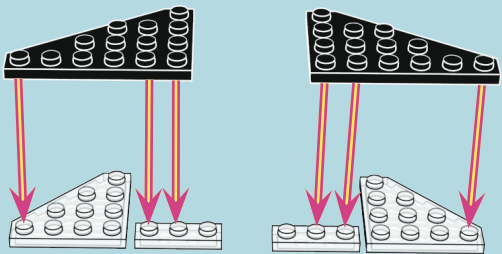

**2**

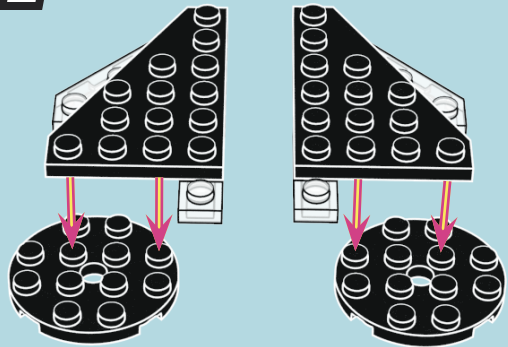

**3**

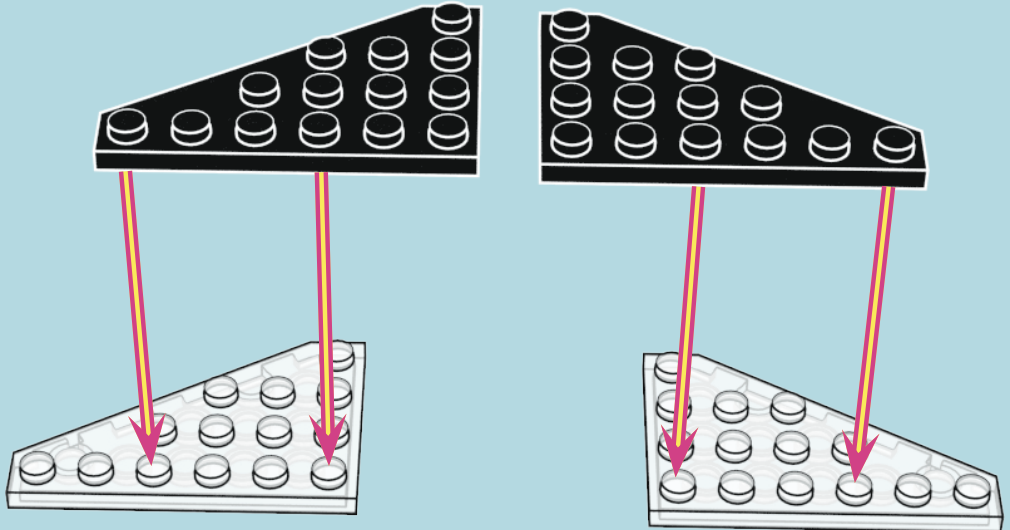
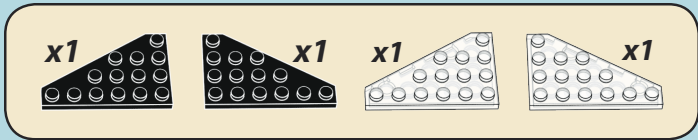



**4**

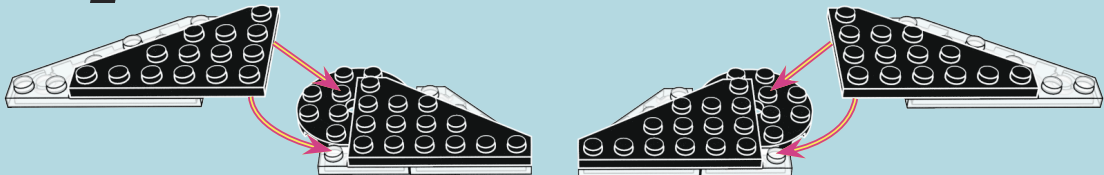

**5**

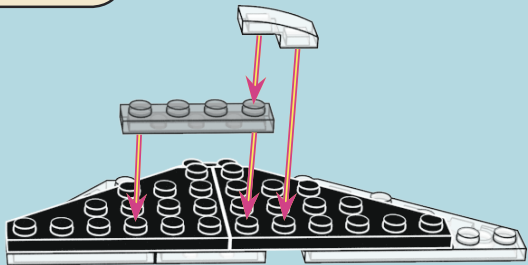
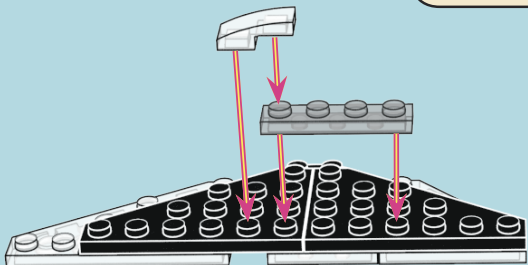
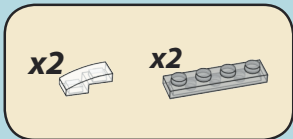

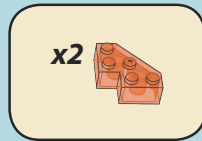
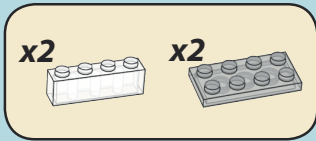

**6**

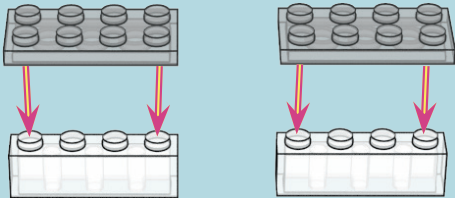

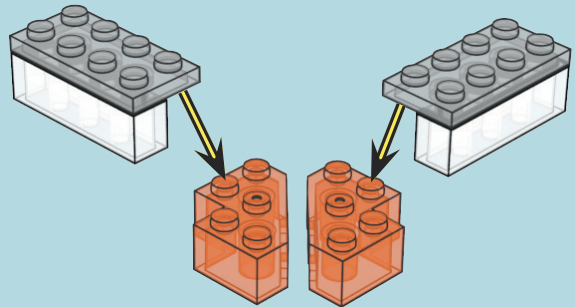

**7**

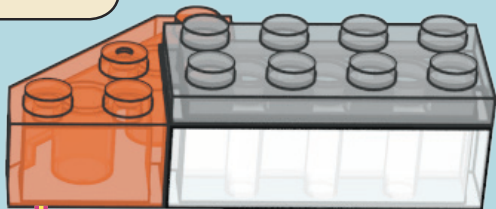
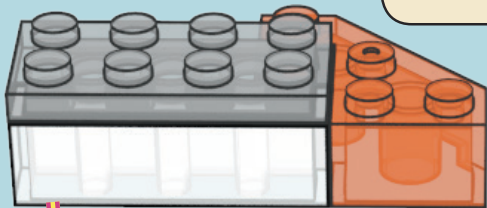
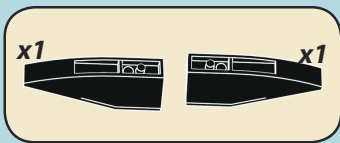

8



9

x2  x2 

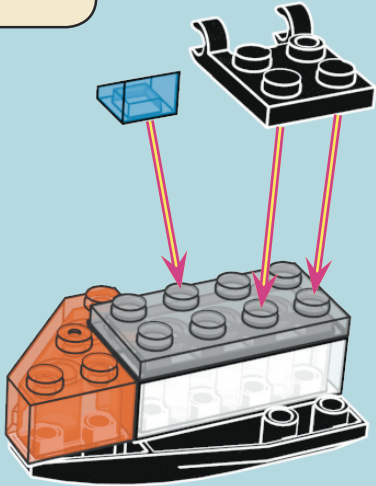
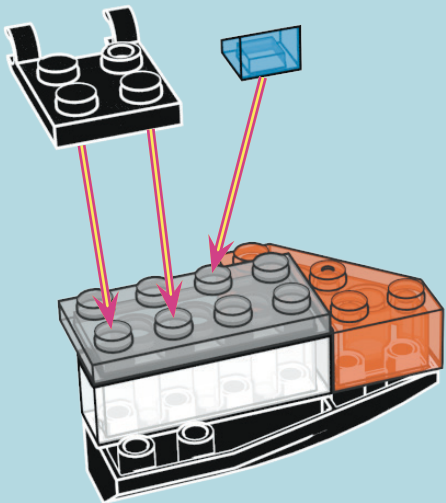

**10**

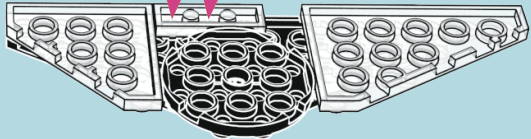
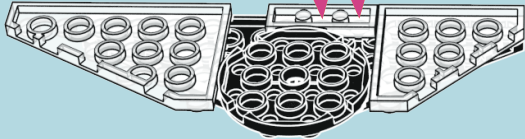
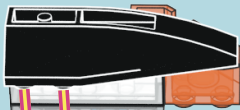

**10a**

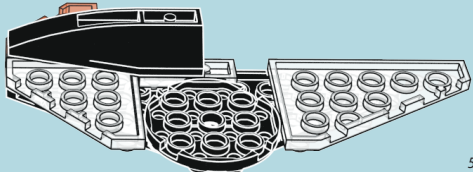
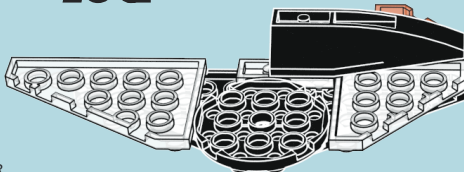

# 11

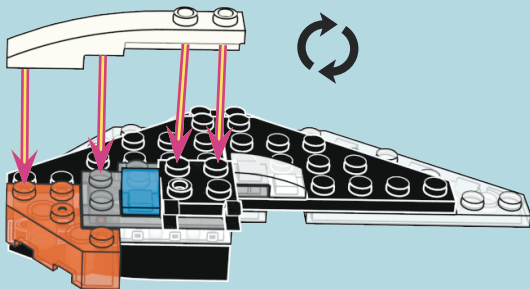
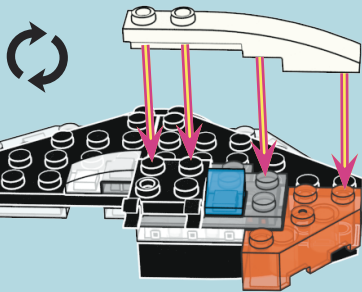
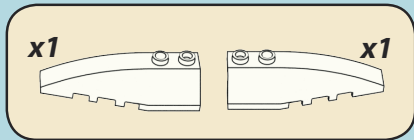

# 11a

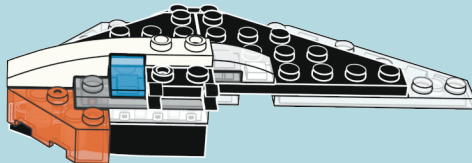
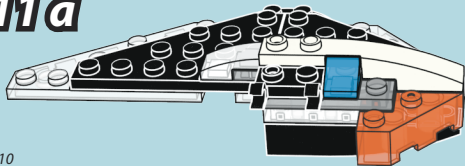

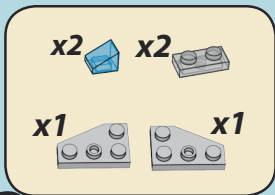

**12**

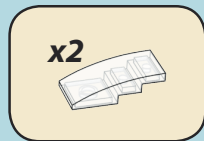
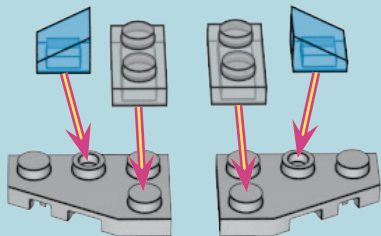

**13**

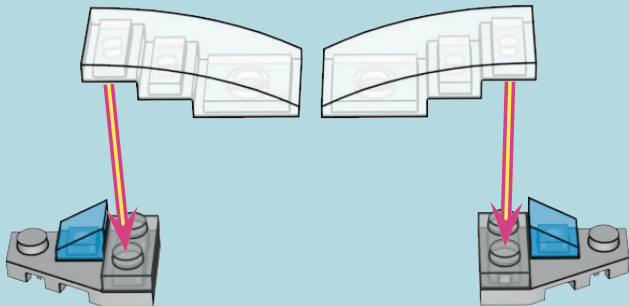



x1



**14**

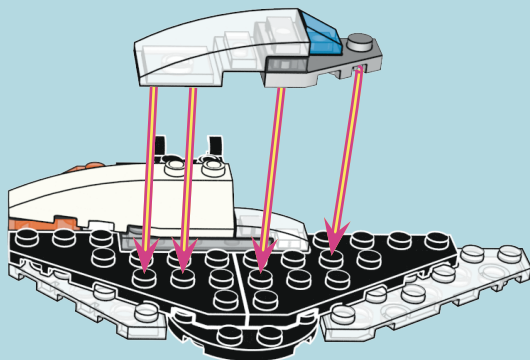
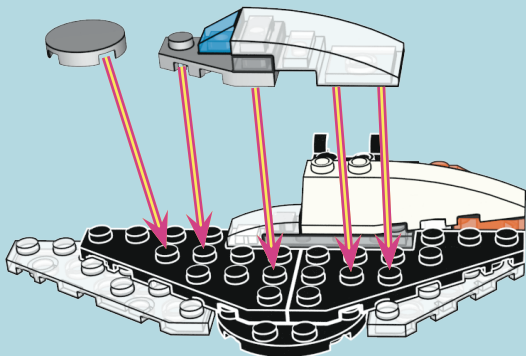

**14a**

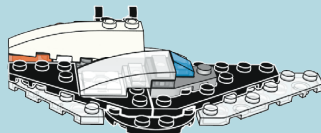
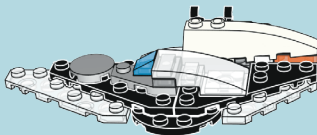

x1



x1

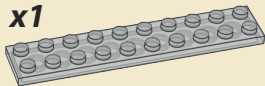

**15**

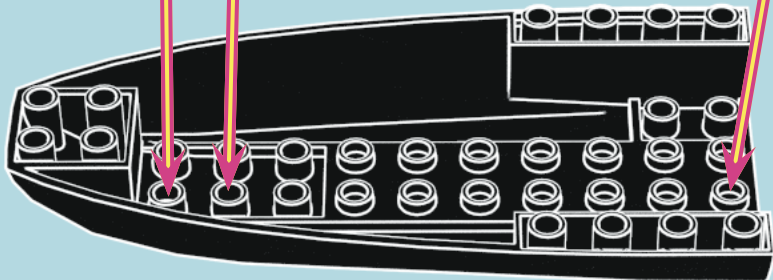
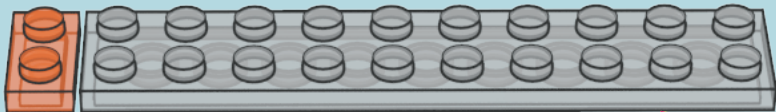

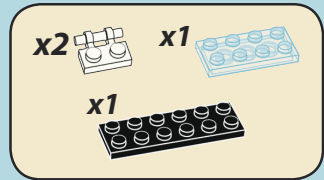
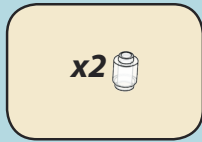

**16**

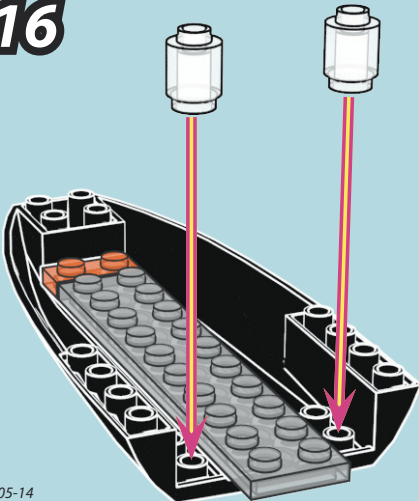

**17**

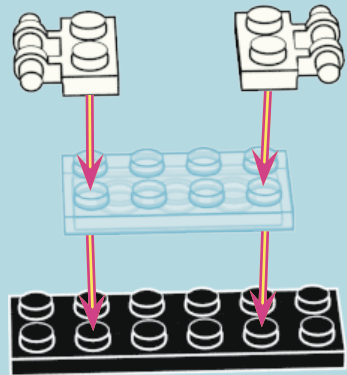

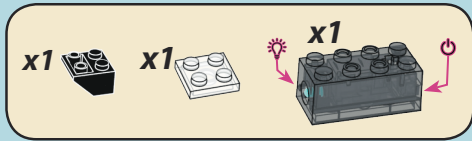

18

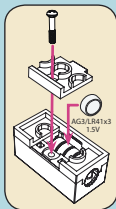
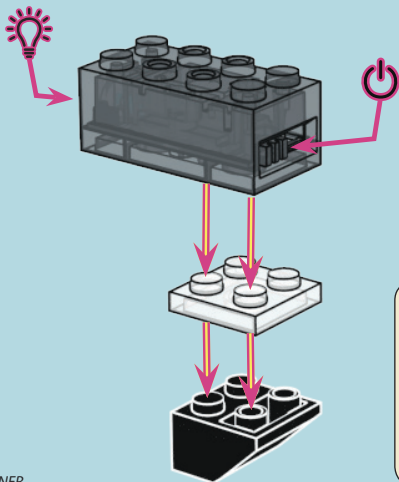

19

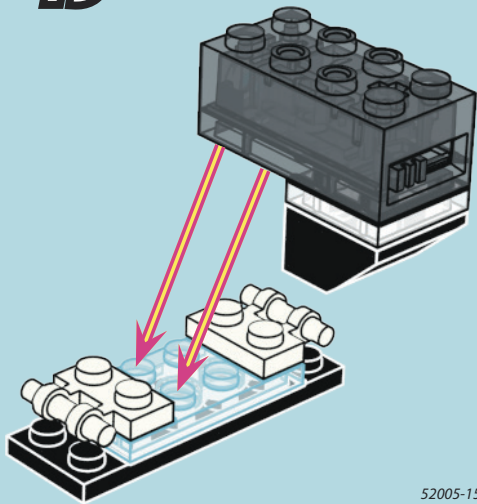

x2



x1



20

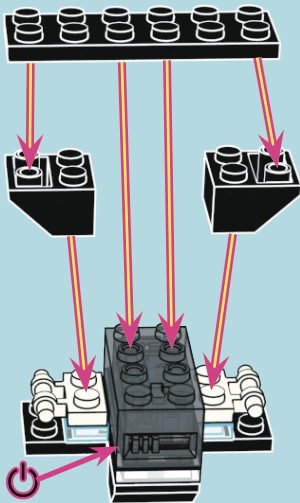

52005-16

x2



x1



21

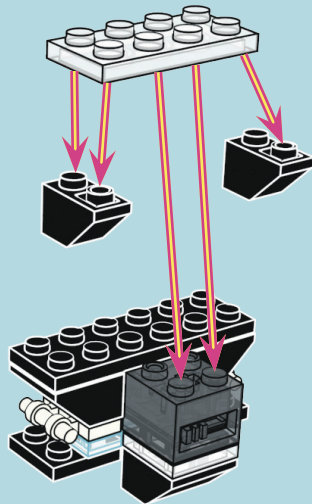

TRAINER

x4



x2



x2



**22**

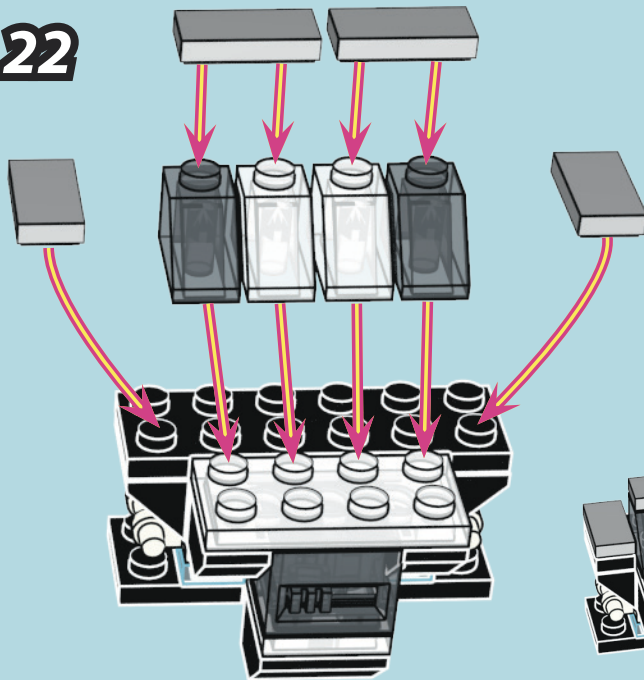

**22a**

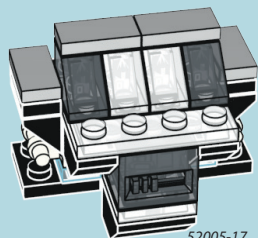

**23**

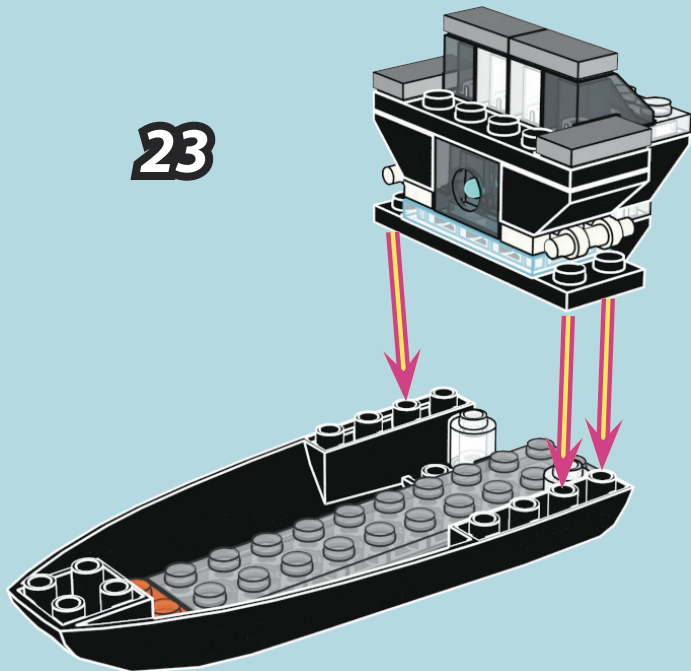



x2 

x1 

x1 

x1 

**24**

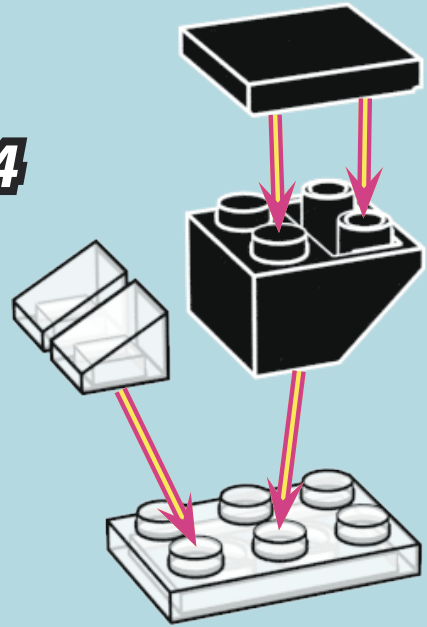

x1



x1



x1



x1



**25**

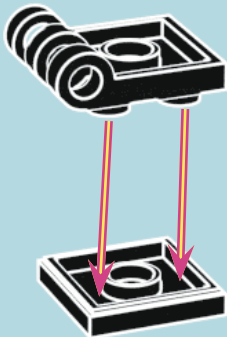

**26**

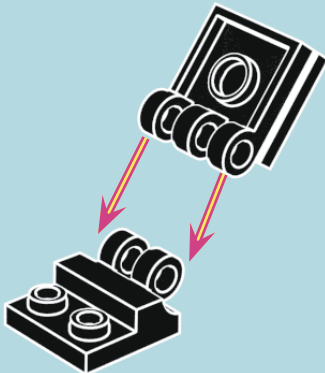

**27**

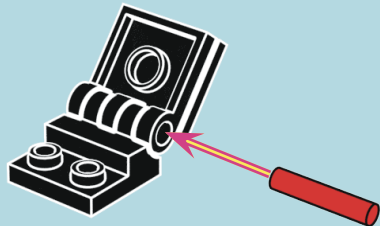

**28**

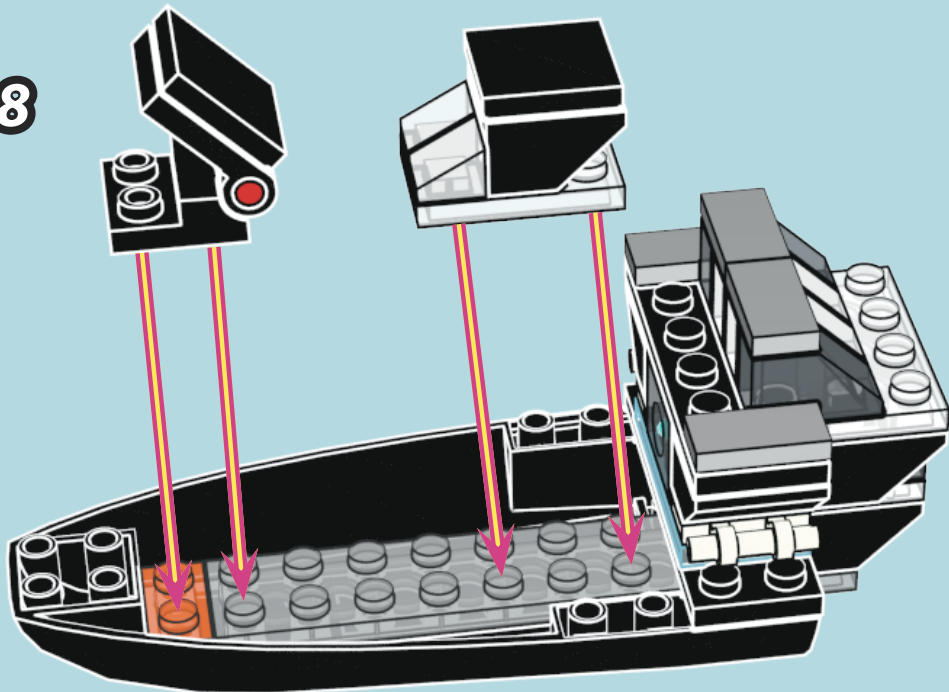

x1



x1

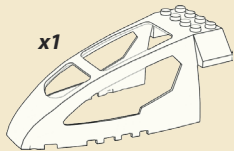

**29**

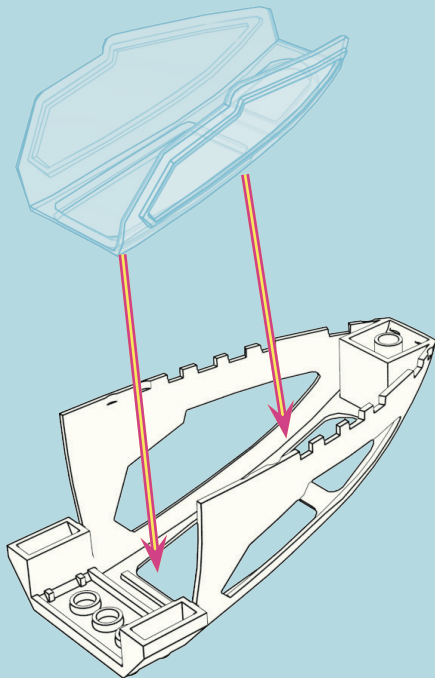

**30**

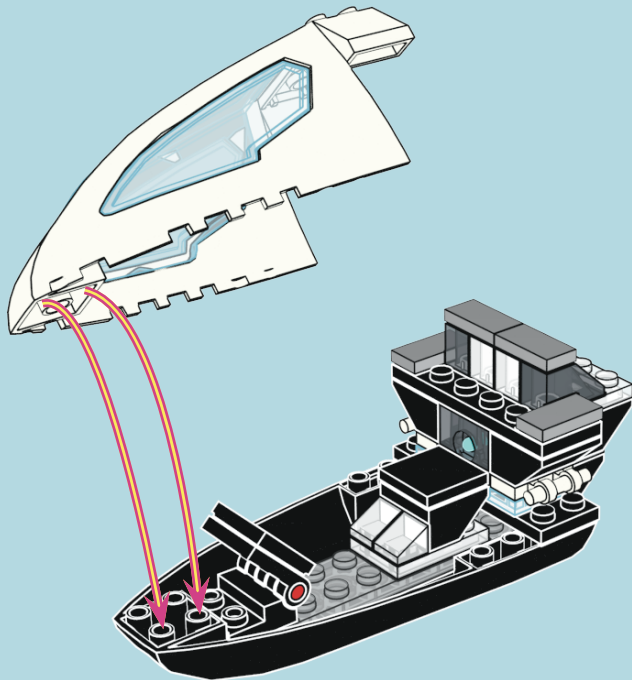

**31**

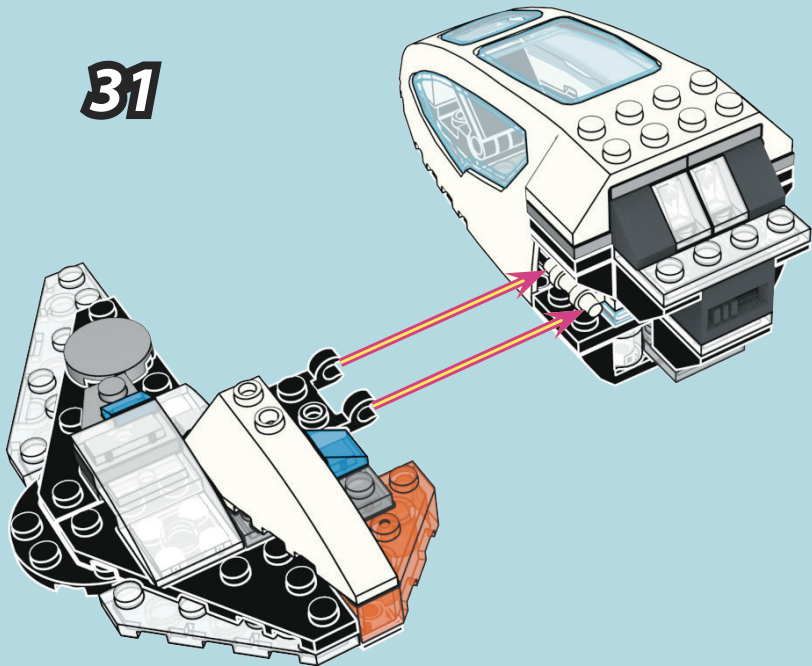

**32**

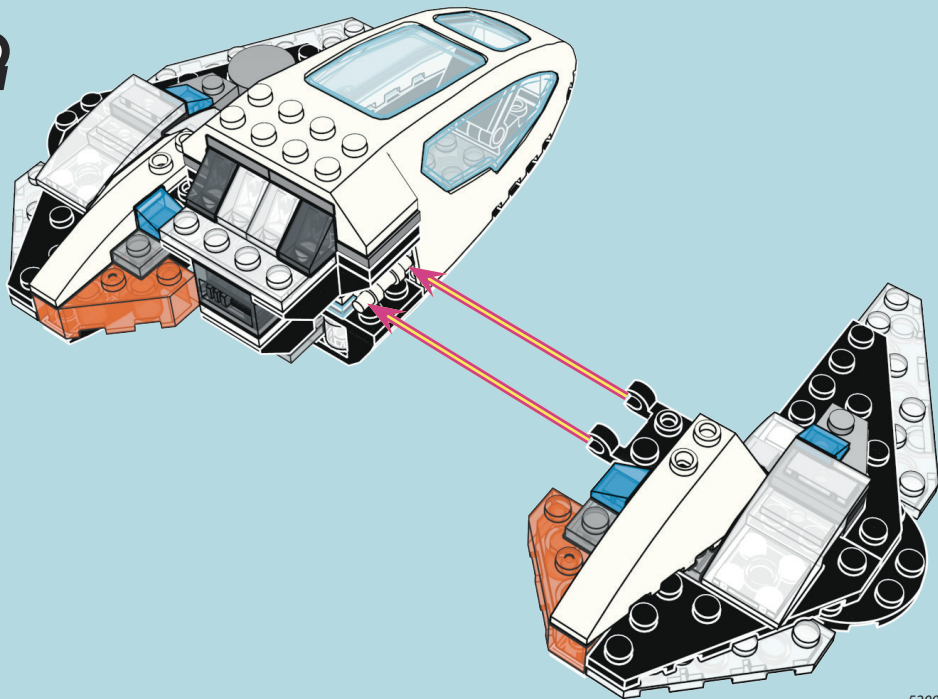



**Questions?? email: [info@neverwrongtoys.com](mailto:info@neverwrongtoys.com)**  
**Des questions?? Allez à: [info@neverwrongtoys.com](mailto:info@neverwrongtoys.com)**

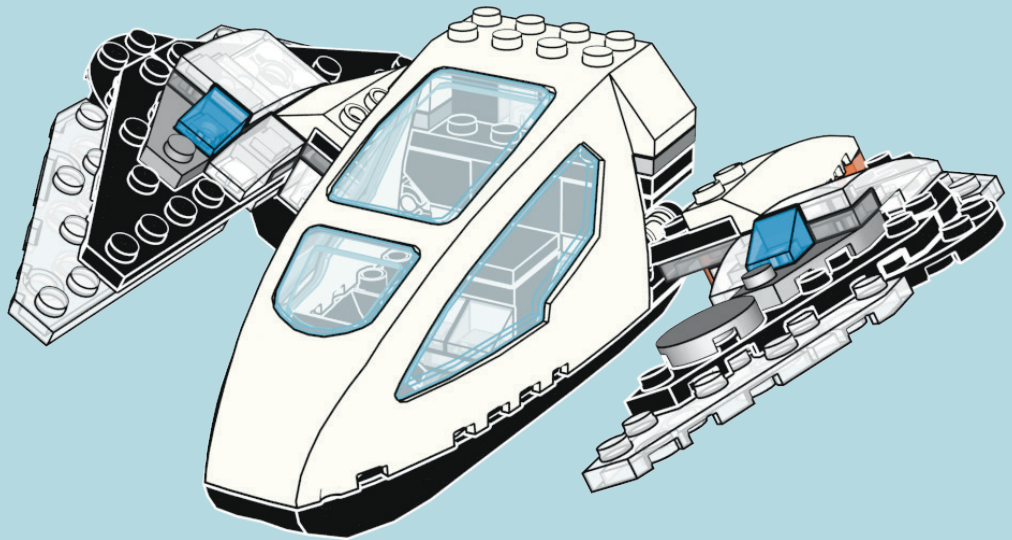

**LASER PEGS**



**TRANSPORT**



**COBRA**



**TRAINER  
SIMULATEUR  
DE COURSE**

**4 WAYS TO BUILD!  
4 OPTIONS  
DE CONSTRUCTION**



**MICROHAWK  
FAUCON**

**MULTI-  
MODELS  
4 IN 1**

All additional model instructions can be viewed online at [www.LaserPegs.com](http://www.LaserPegs.com)

Toutes les instructions supplémentaires du modèle peuvent être consultées en ligne sur [www.LaserPegs.com](http://www.LaserPegs.com)

[www.neverwrongtoys.com](http://www.neverwrongtoys.com)

Copyright 2021 © All Rights Reserved  
U.S. Patent No. 8,864,546 & Other  
Patents Pending.

**NEVER  
WRONG**  
Toys & Games