

LASER PEGS

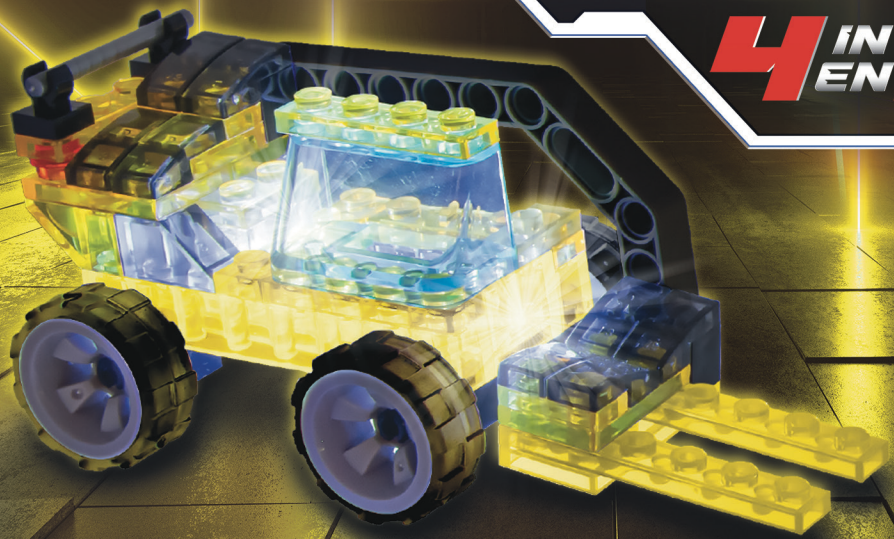

**MULTI-
MODELS**

4 IN 1



www.LaserPegs.com/52004/FORKLIFT

x2 
90008-109C

x1  x1 
90019-116C 90020-116C

x3 
10022-109C

x3 
10023-109C

x6 
10024-109C

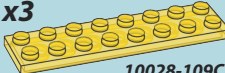

x2 
10026-109C



x3 
10028-109C



x2  x2 
90018-109C 10012-109C

x8 
10014-109C

x2 
10016-109C

x2  x2 
40003-109C 40011-109C



x2  x1 
30012-109C 30022-109C

x1  x1 
40004-109C 40005-109C

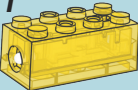
x2 
30018-109C

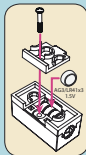
x1 
LB101-109C



x2  x8 
80000-032C 40006-10C

x3 
90021-Silver C

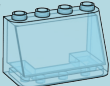
x1  x1 
30012-Clear 90006-2975C

x4  x6  x2 
348-G7124 55-K2048 347-K2048

x4 
70013-6C2X

x2  x2 
322-K2048 323-K2048

x4  x4 
70008-Silver C 70004-6C2X

x2 
331-K2048

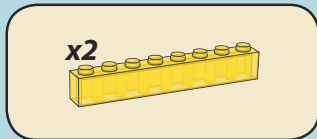

Scan for additional model instructions
Rechercher des instructions supplémentaires sur le modèle

1

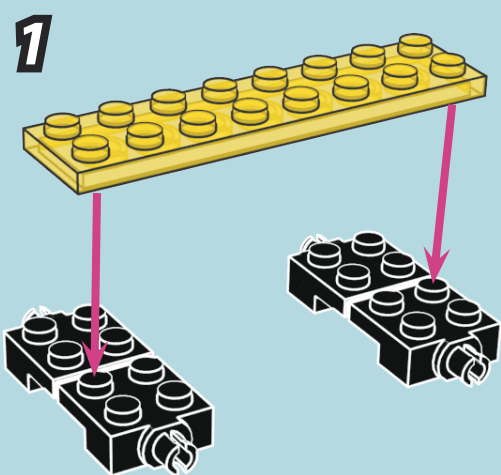

2

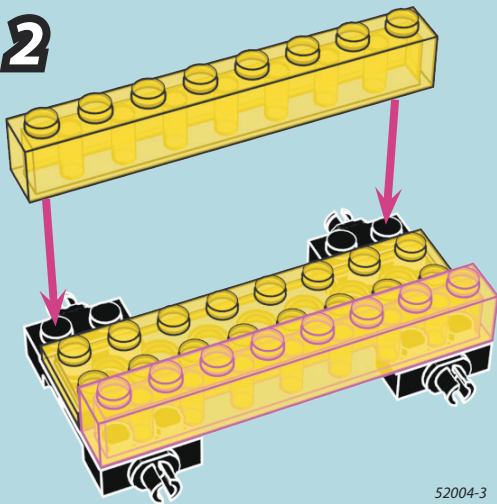

x2



x1

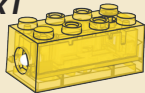

3

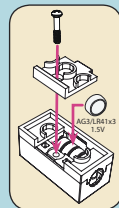
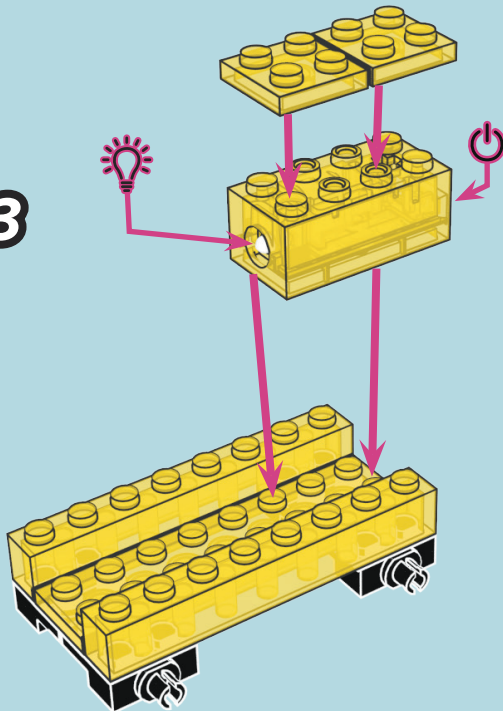

x1



x2



x2



4

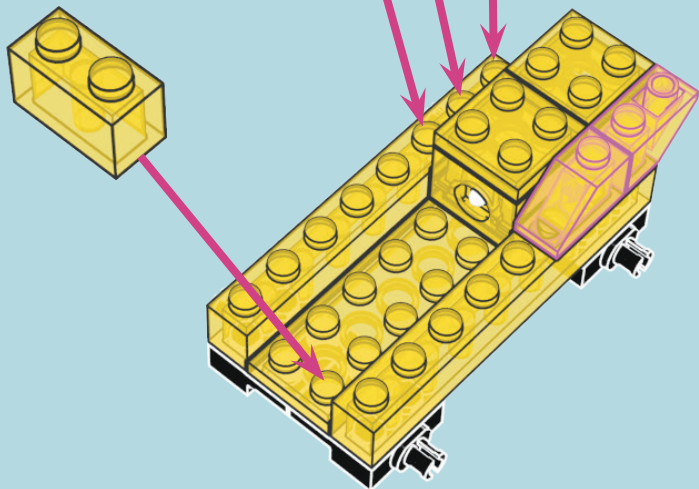

x3



5

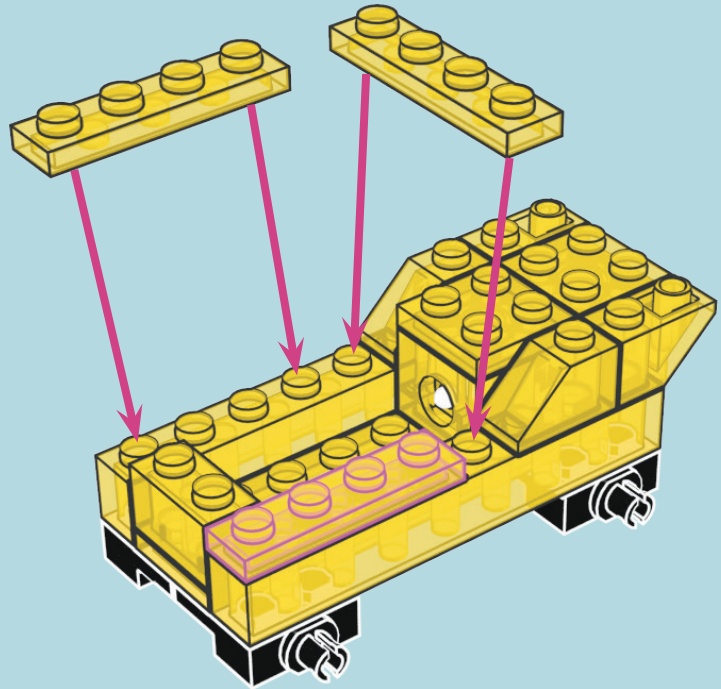

x2



6

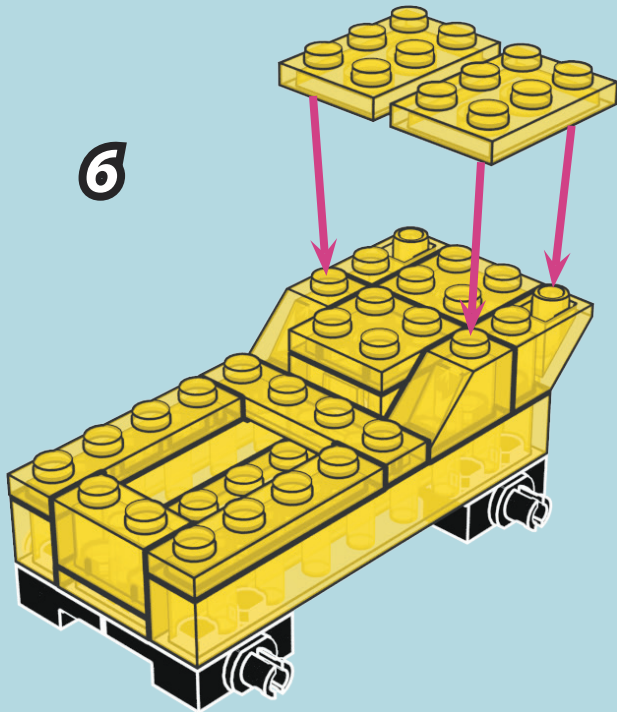

x2



x1



7

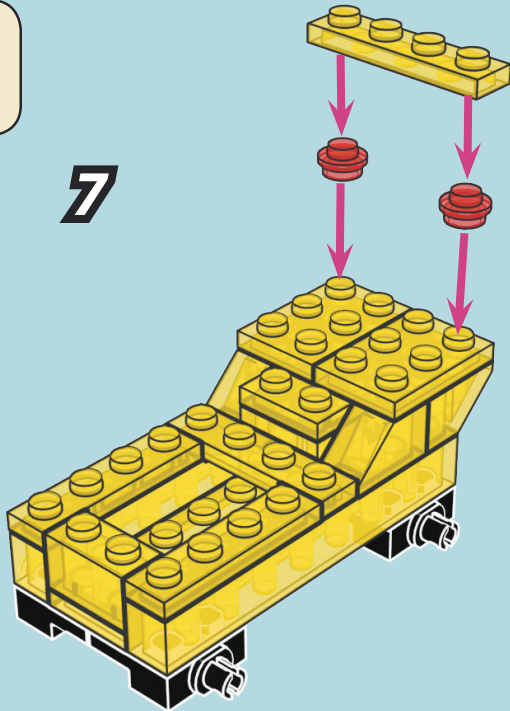

x1



x1



x1



8

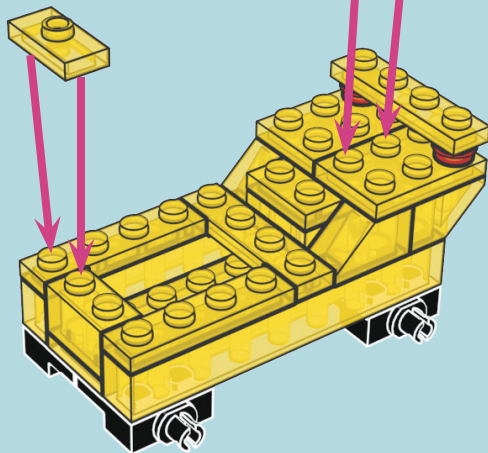

x1 

x2 

x1 

x1 

9

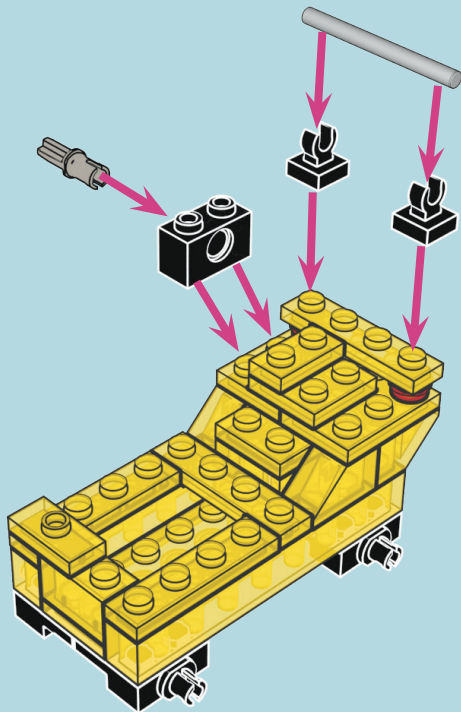

x4



10

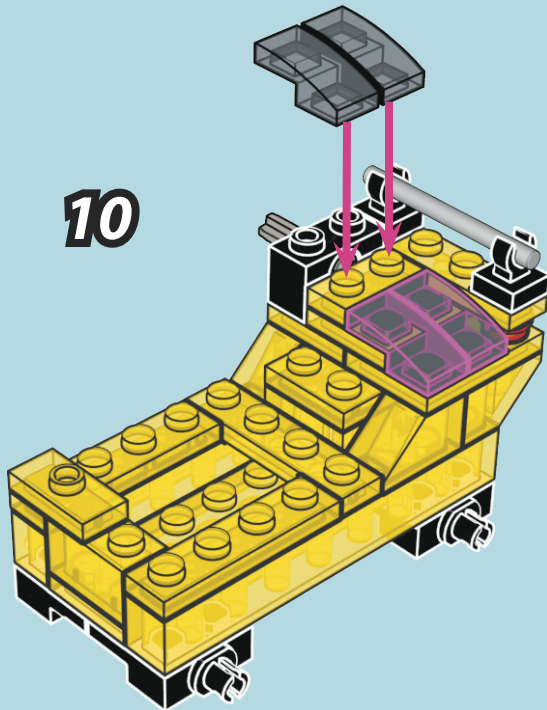

x1



x1



11

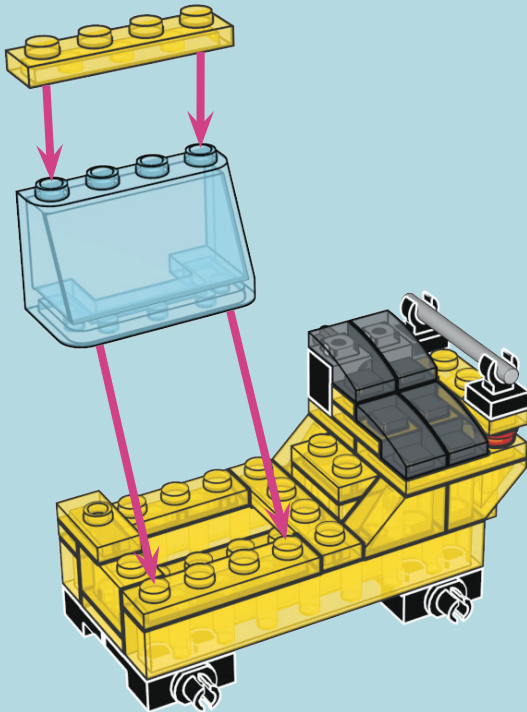

x4



x4



13



12

x4



x4

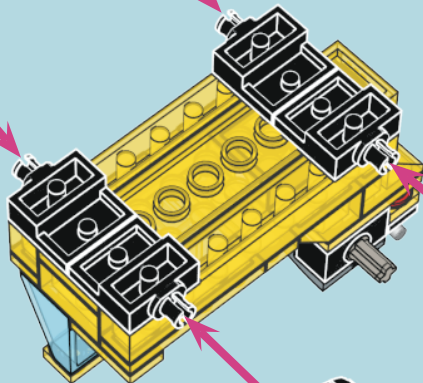
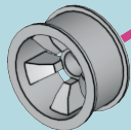

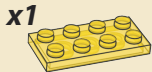

14

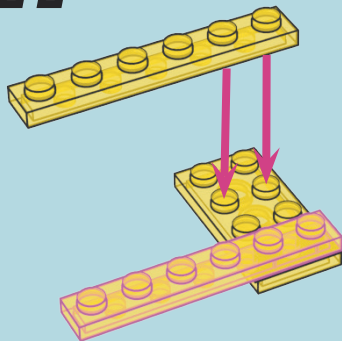

15

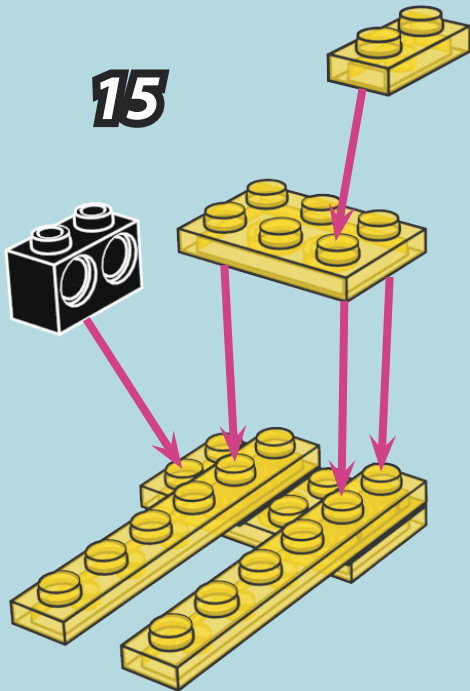

x4



x1



16

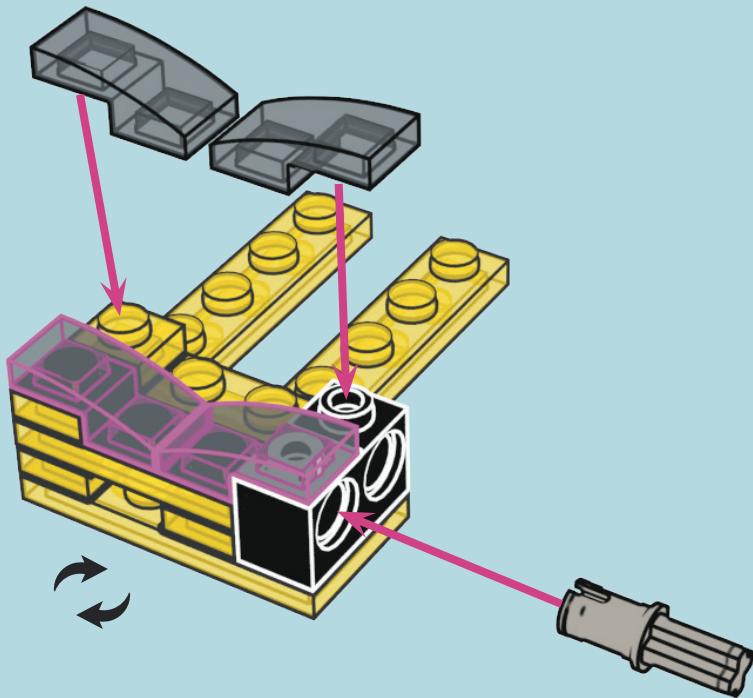

x1

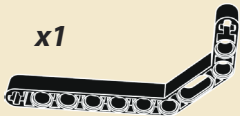

17

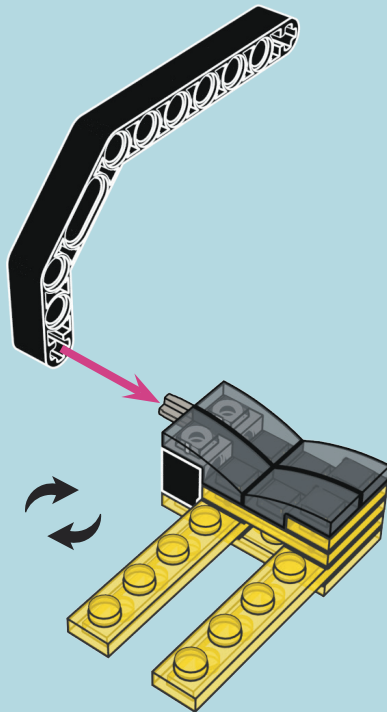

18

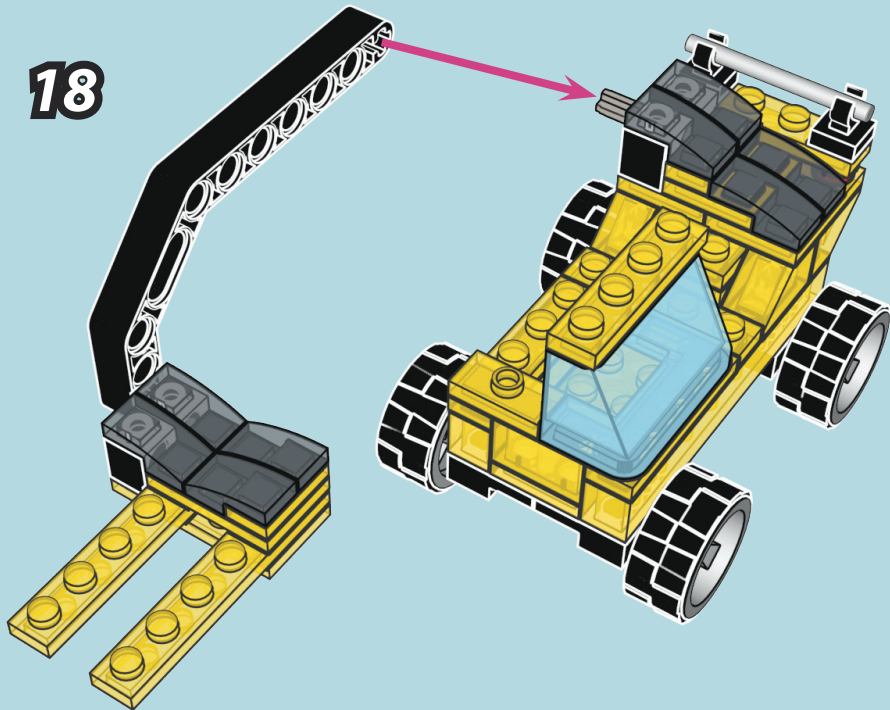

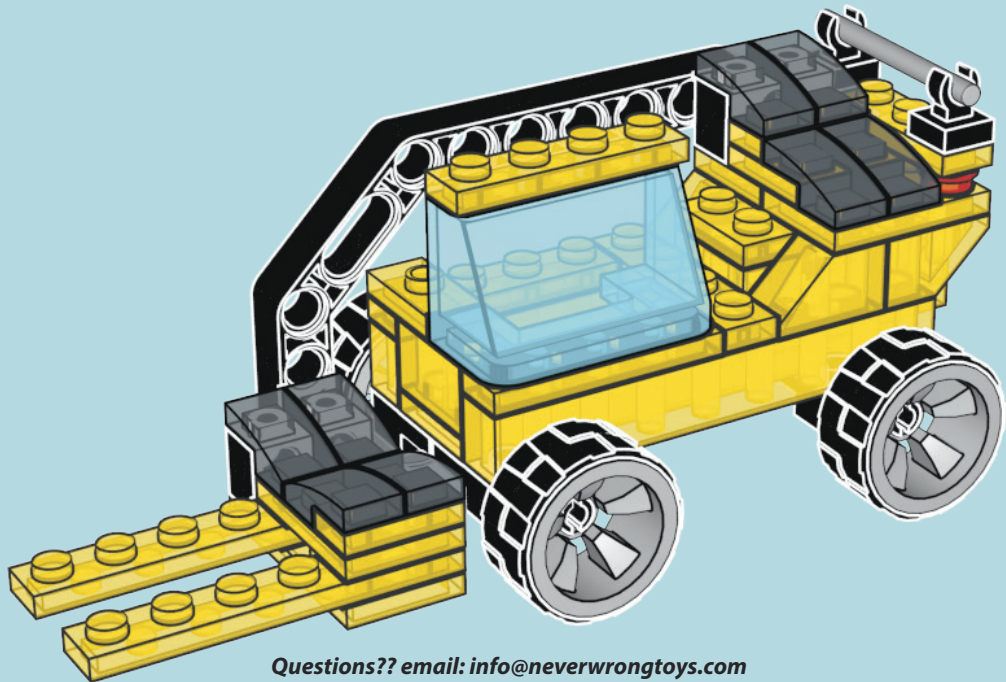

LASER PEGS



EXCAVATOR
EXCAVATEUR



GRADER
NIVELEUSE



FORKLIFT
CHARIOT ÉLEVATEUR

4 WAYS TO BUILD!
4 OPTIONS DE CONSTRUCTION!



BOBCAT
CHARGEUSE
COMPACTE

MULTI-
MODELS
4 IN 1

All additional model instructions can be viewed online at www.LaserPegs.com
Toutes les instructions supplémentaires du modèle peuvent être consultées en ligne sur www.LaserPegs.com

www.neverwrongtoys.com
Copyright 2021 © All Rights Reserved
U.S. Patent No. 8,864,546 & Other Patents Pending.

NEVER
WRONG
Toys & Games