

LASER PEGS

**MULTI-
MODELS**

**4 IN
EN 1**



www.LaserPegs.com/52004/BOBCAT

WARNING: CHOKING HAZARD-
Small parts. Not for children under 3 yrs.
Do not submerge in water.

ATTENTION: DANGER DE SUFFOCATION-
Petits éléments. Ne convient pas aux enfants de
moins de trois ans. Ne pas immerger le jeu dans l'eau.

x2
90008-109C



x2 90018-109C x2 10012-109C



x2 80000-032C x8 40006-10C



x1 90019-116C x1 90020-116C



x8
10014-109C



x3
90021-Silver C



x3
10022-109C



x2
10016-109C



x1 30012-Clear x1 90006-2975C

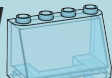

x3
10023-109C



x2 40003-109C x2 40011-109C



x4 348-G7124 x6 55-K2048 x2 347-K2048



x6
10024-109C

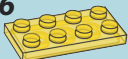

x2 30012-109C x1 30022-109C



x4
70013-6C2X



x2
10026-109C

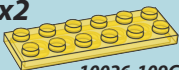

x1 40004-109C x1 40005-109C



x2 322-K2048 x2 323-K2048



x3
10028-109C



x2
30018-109C

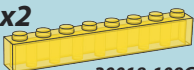

x1
LB101-109C

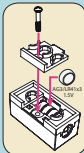
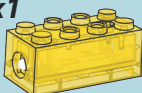

x4 70008-Silver C x4 70004-6C2X



x2
331-K2048



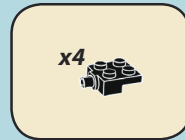
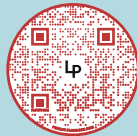
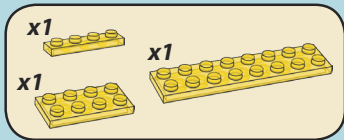

Scan for additional model instructions
Rechercher des instructions supplémentaires sur le modèle

1

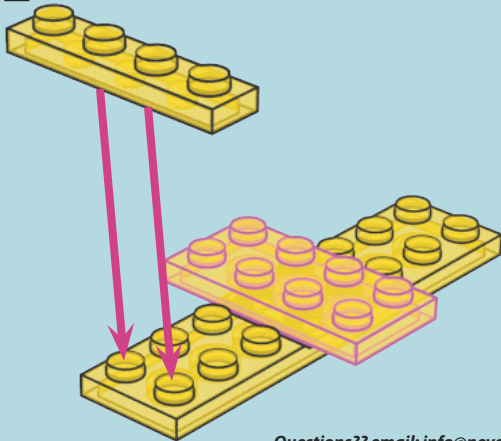

2

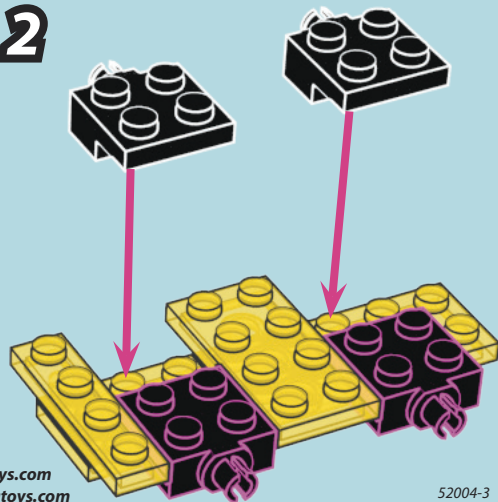



3

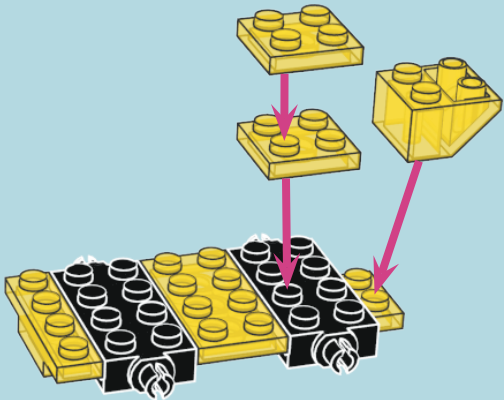

4

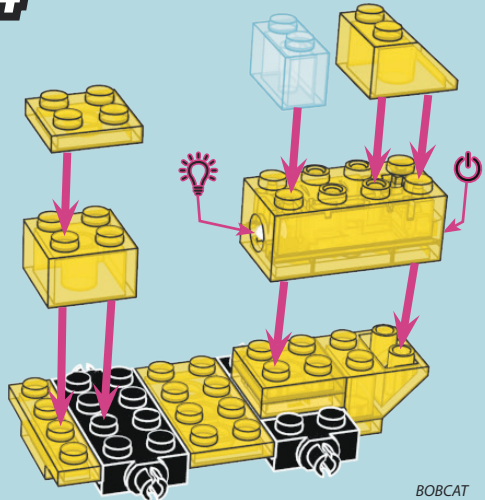

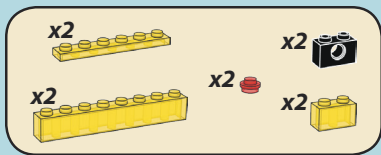

5

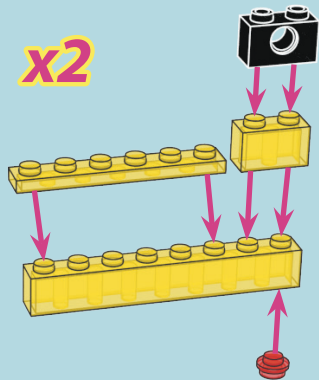

6

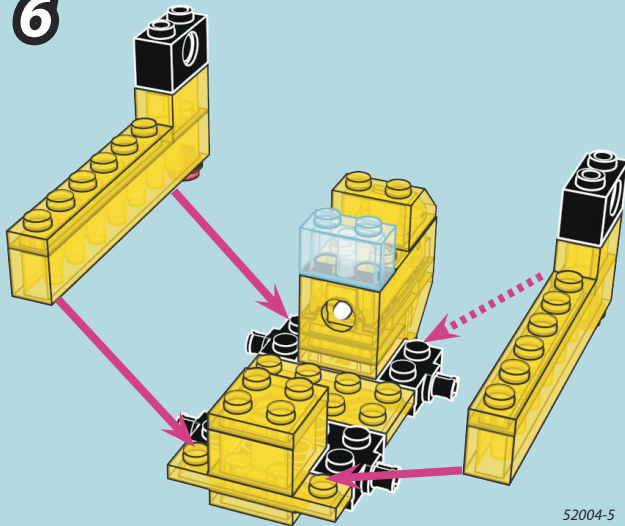



7

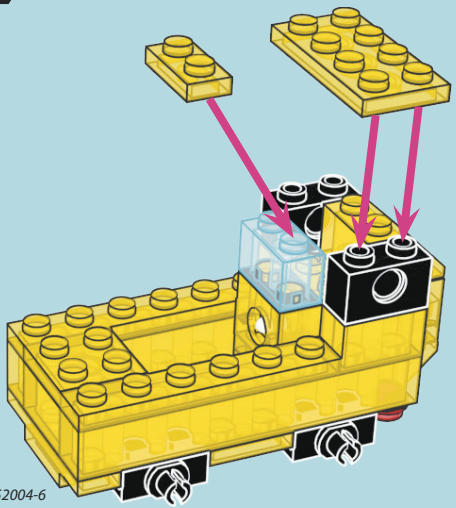

52004-6

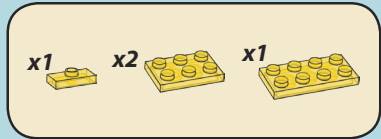

8

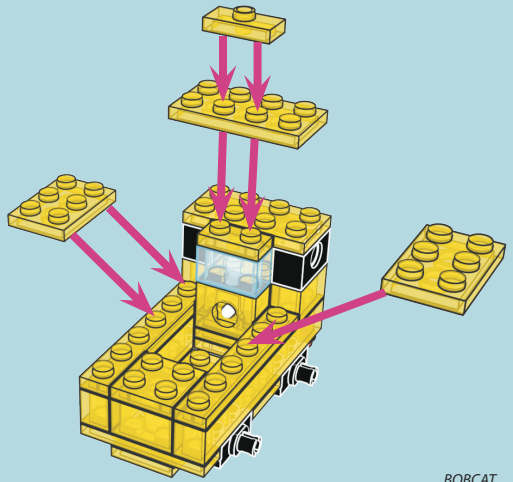

BOBCAT

x2



9

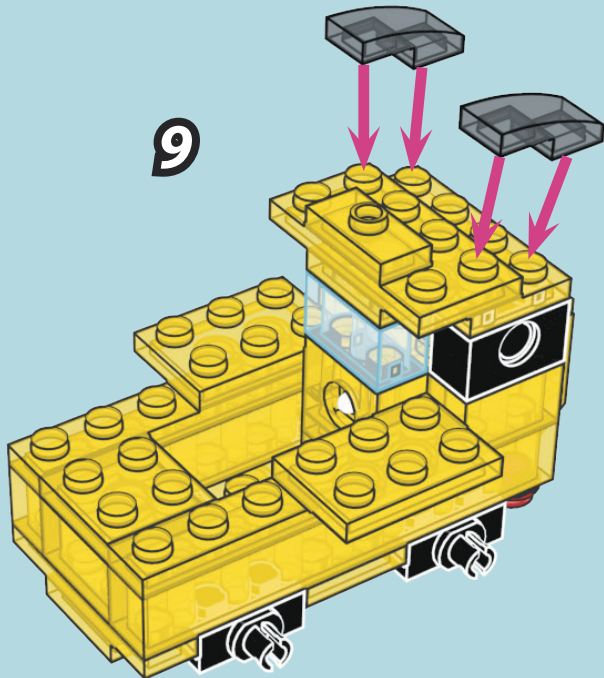



10

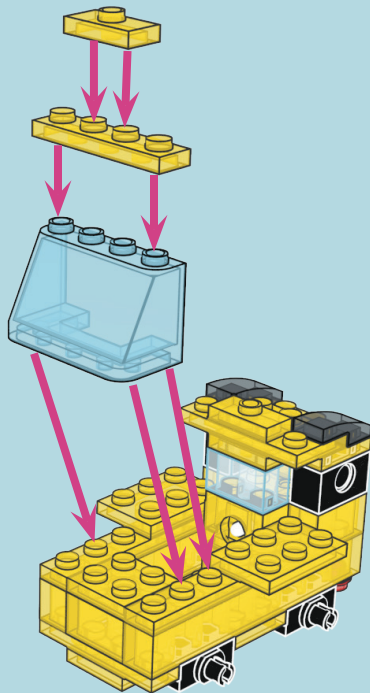

x6



11

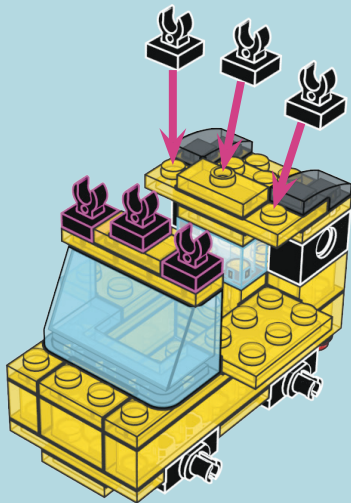

x3



12

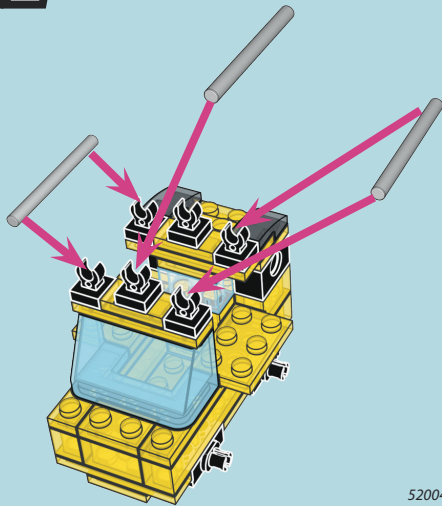

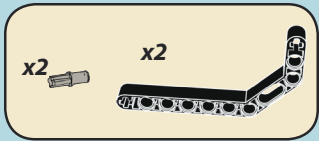

13

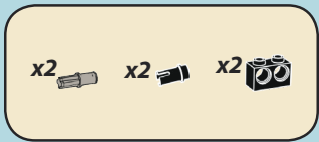
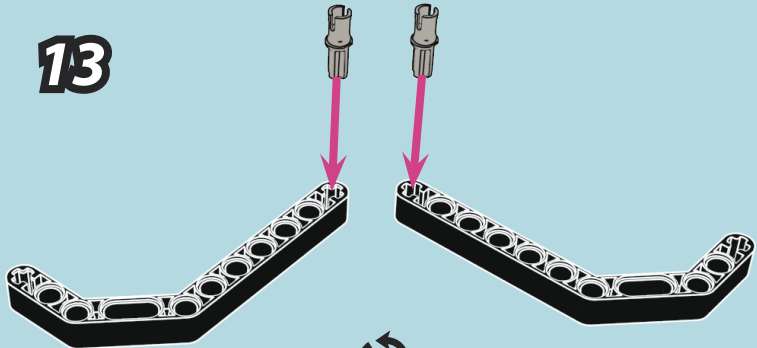

14

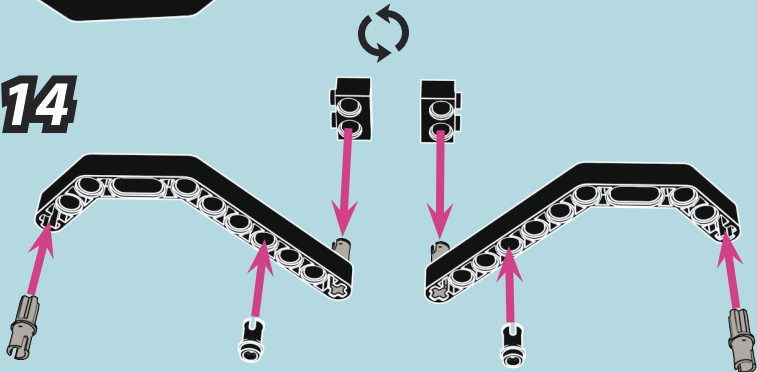

15

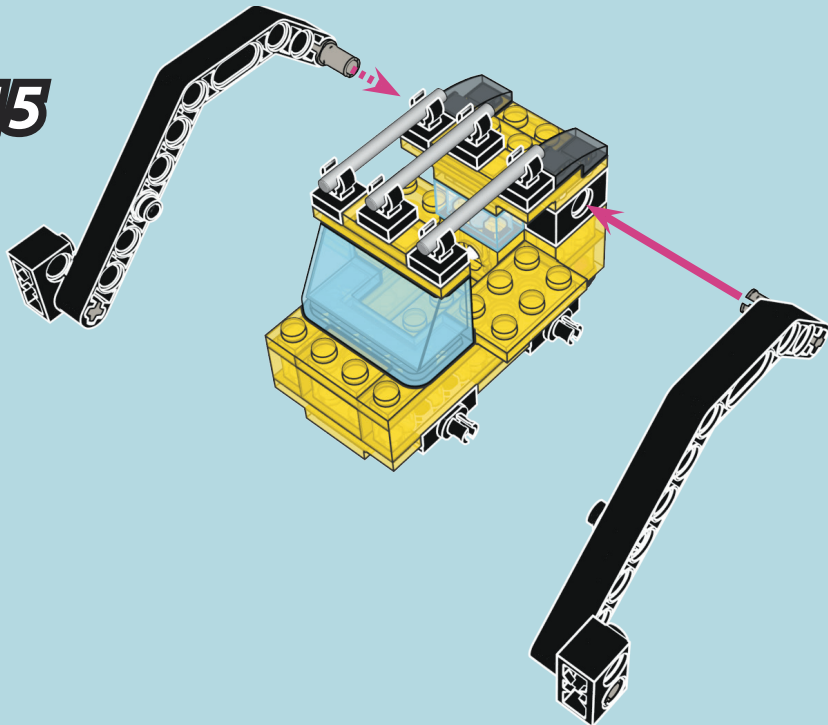

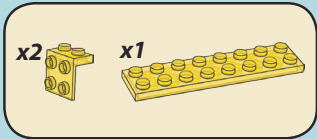

16

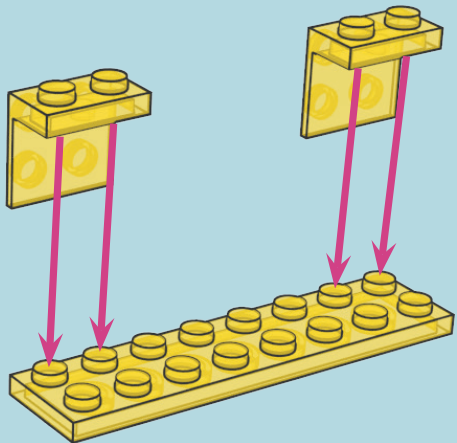

17

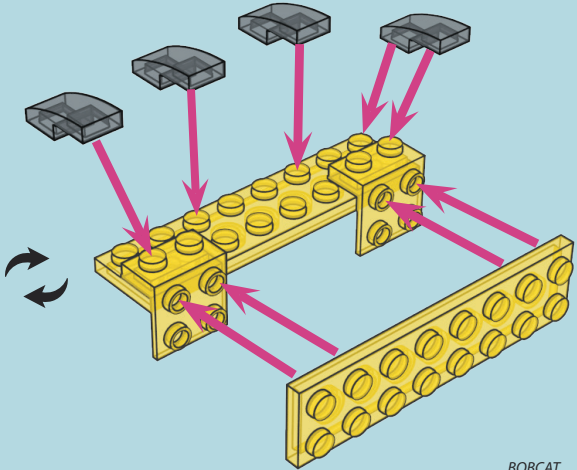

x2



18

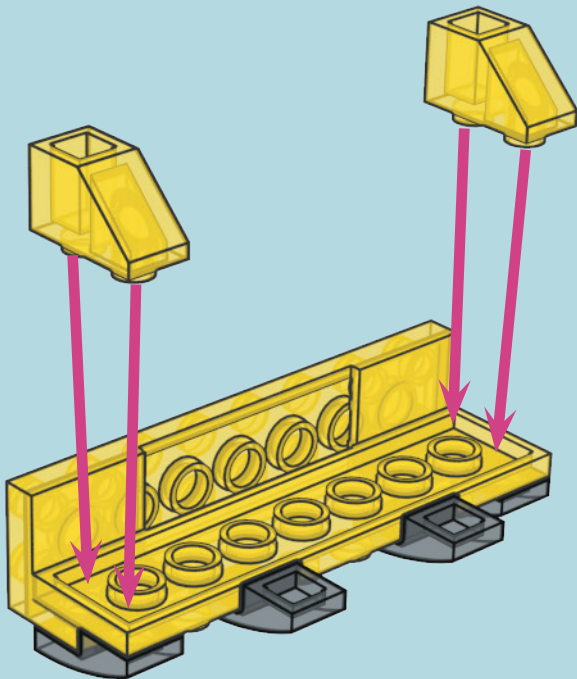

19

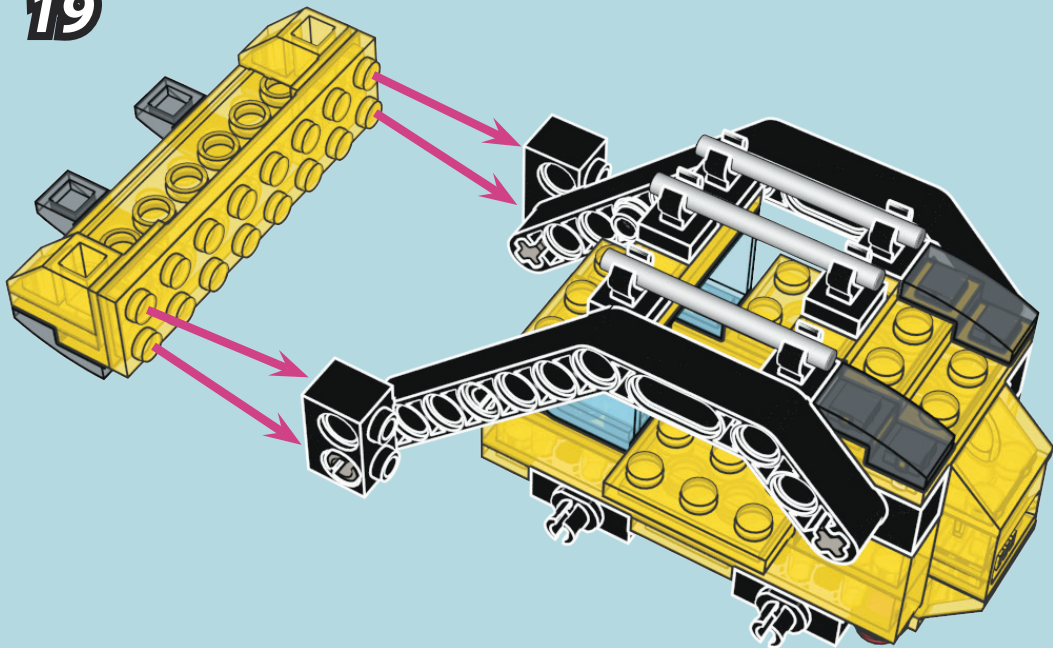



20

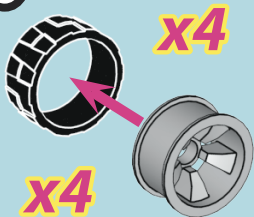

21

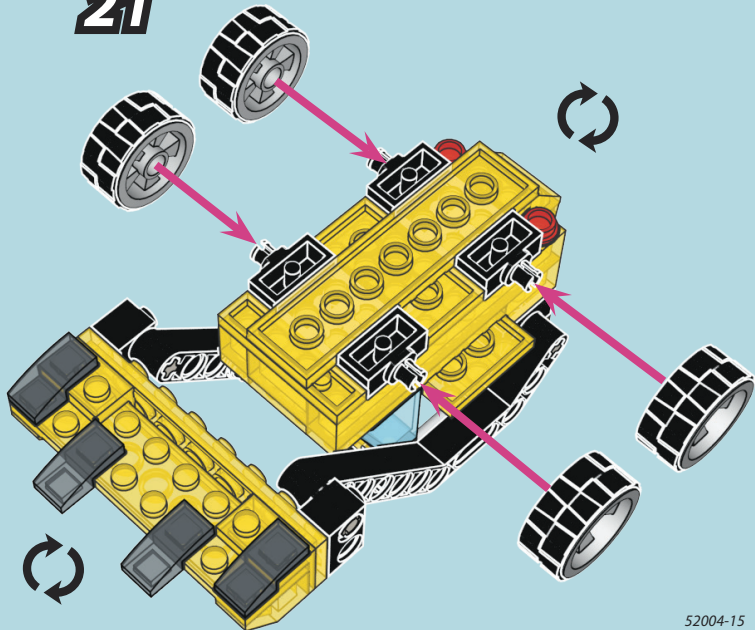

LASER PEGS



EXCAVATOR
EXCAVATEUR



GRADER
NIVELEUSE



FORKLIFT
CHARIOT ÉLEVATEUR

4 WAYS TO BUILD!
4 OPTIONS DE CONSTRUCTION!



BOBCAT
CHARGEUSE
COMPACTE

MULTI-
MODELS
4 IN 1

All additional model instructions can be viewed online at www.LaserPegs.com
Toutes les instructions supplémentaires du modèle peuvent être consultées en ligne sur www.LaserPegs.com

www.neverwrongtoys.com
Copyright 2021 © All Rights Reserved
U.S. Patent No. 8,864,546 & Other Patents Pending.

NEVER
WRONG
Toys & Games