

LASER PEGS

CREATURES



**LIGHT-UP
BUILDING TOY**
**JOUET DE
CONSTRUCTION
LUMINEUX**

**CHICKEN
AND
ROOSTER
20411**

LaserPegs.com/Instructions-Manuals



WARNING: CHOKING HAZARD-
Small Parts. Not for children under 3 yrs.



ATTENTION: DANGER D'ÉTOUFFEMENT.
- Petits éléments. Ne convient pas aux enfants de moins de trois ans.

x4



80000-6C2X

x1



10011-032C

x4



40010-032C

x8



40006-7527C

x4



90008-CLEAR

x1



80004-467C

20411-2

x4



40010-109C

x4



80002-109C

x4



10022-109C

x2



40006-299C

x2



40012-299C

x1



73-74894

x1



154-74894

x4



90016-TPG

x2



40010-PQTCX

x10



40006-PQTCX

x1



30012-PQTCX

x1



40004-PQTCX

x1

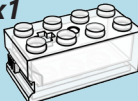

LB100-PQTCX

x2



40010-137C

x8



40006-137C

x2



90018-PQTCX

x3



10012-PQTCX

x1



68-C9121

x4



10022-PQTCX

x1

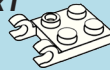

72-C9121

x2



90018-137C

x3



10012-137C

x1



68-36001

x5



10022-137C

x1



30012-137C

x1



40004-137C

x1

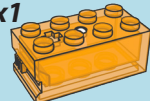

LB100-137C

Chicken & Rooster



1

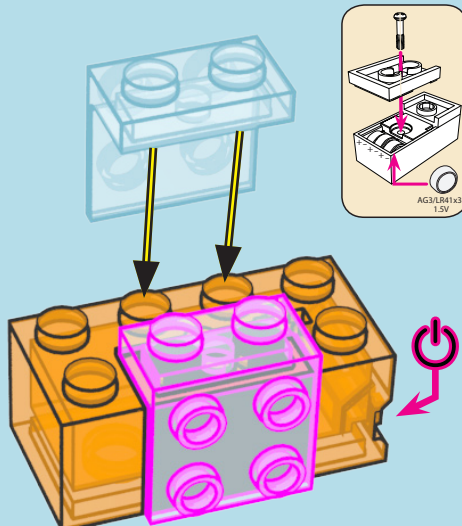

2

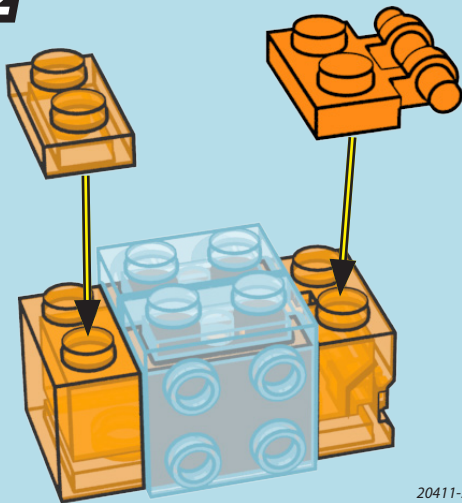

x1



x1



x2



x2



x2



x2



3

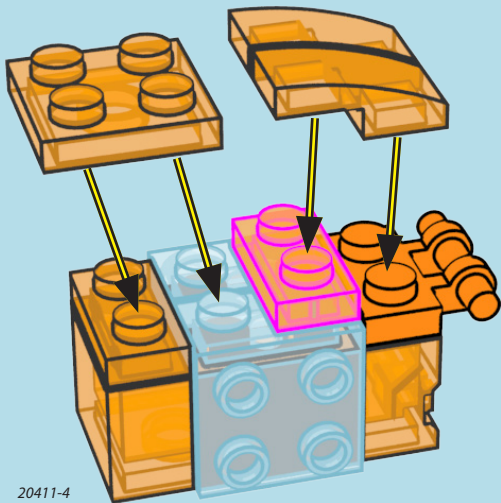

4

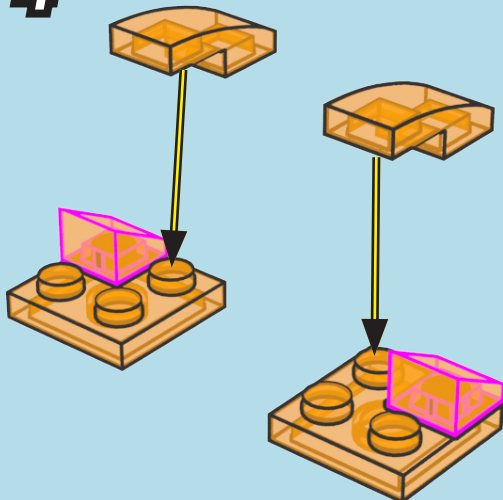

Questions?? Go to: laserpegs.com/support
Des questions?? Allez à: laserpegs.com/support

x4



5

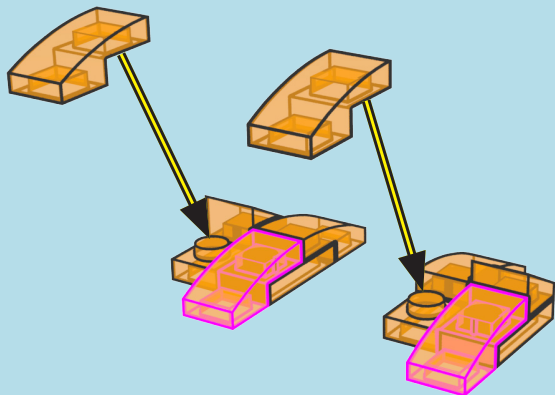

6

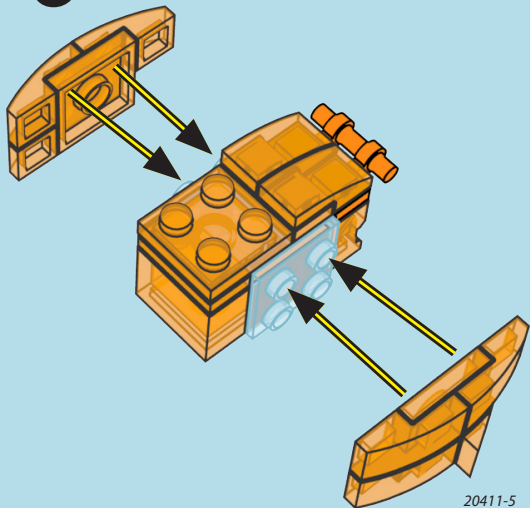

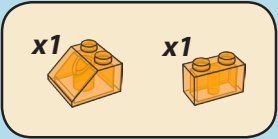

7

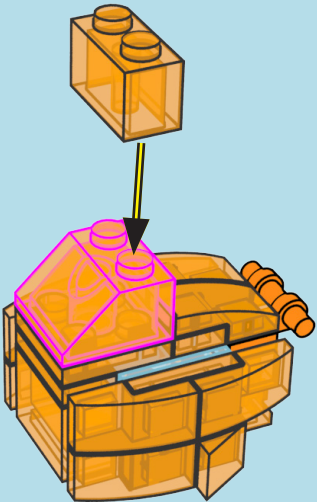

20411-6

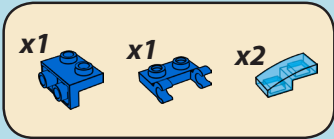

8

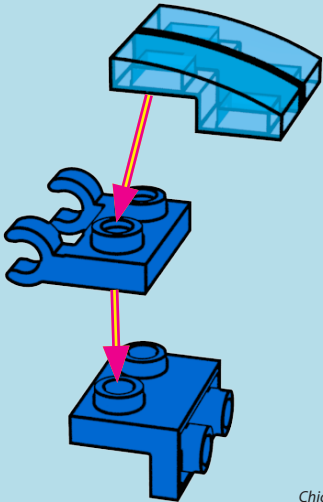

Chicken & Rooster



9

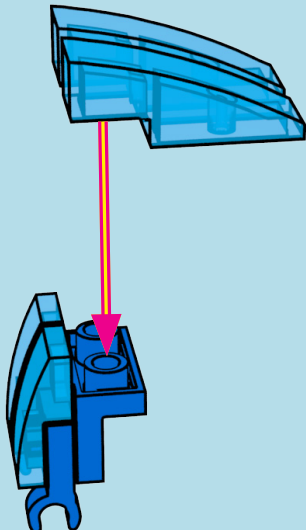

10

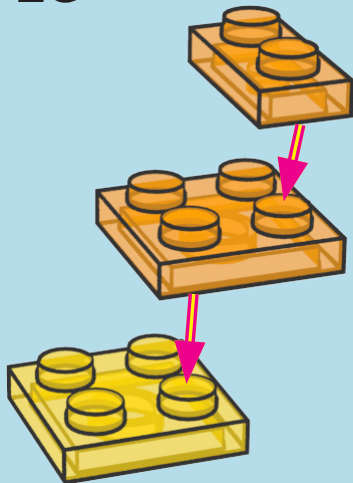

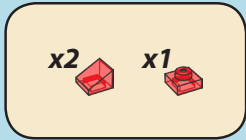

11



12



13

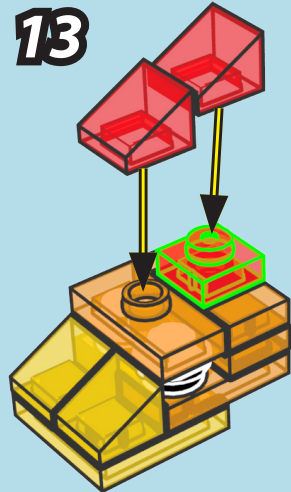

14

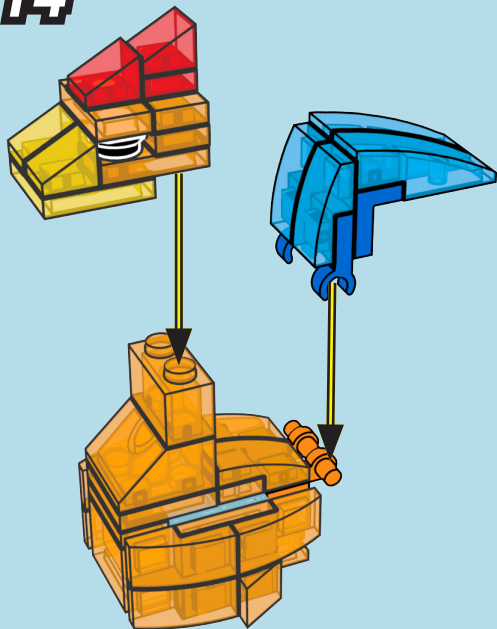

x1



x2



x1



15

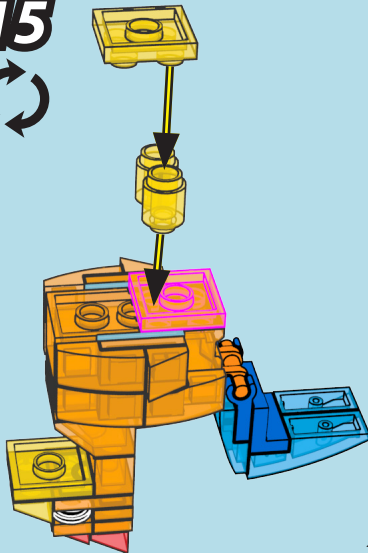

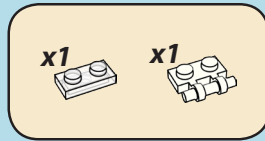
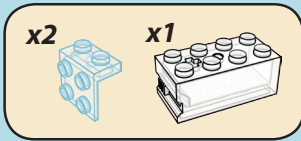
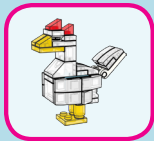

1

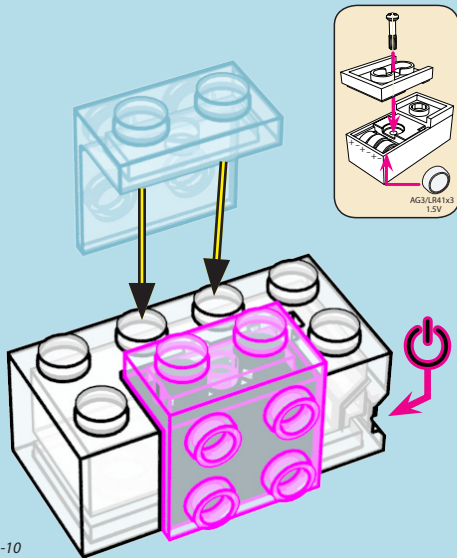

2

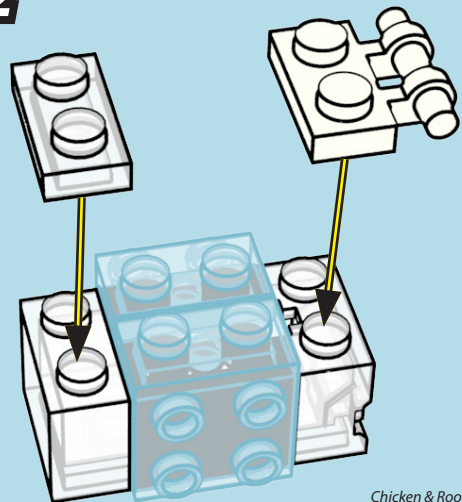

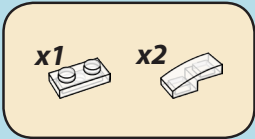

3

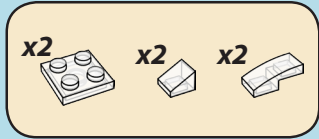
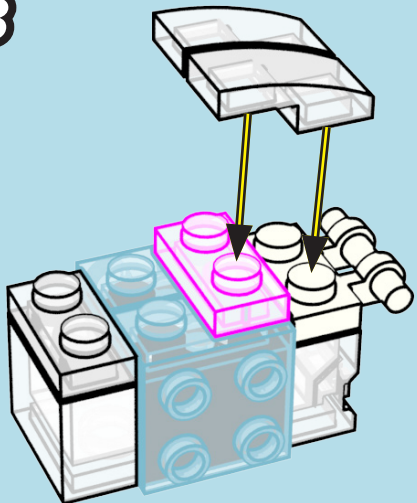

4

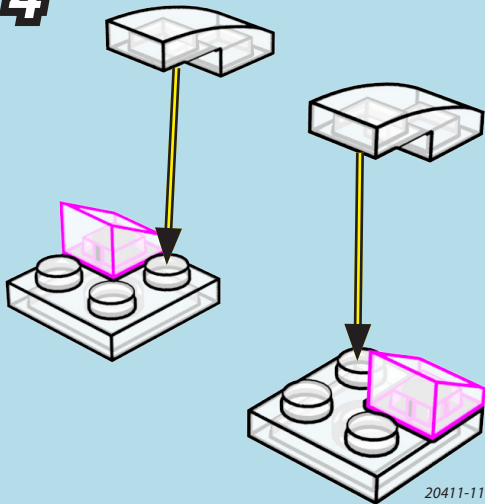

x4



5

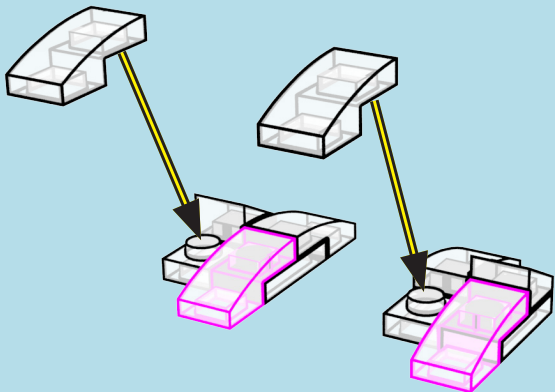

6

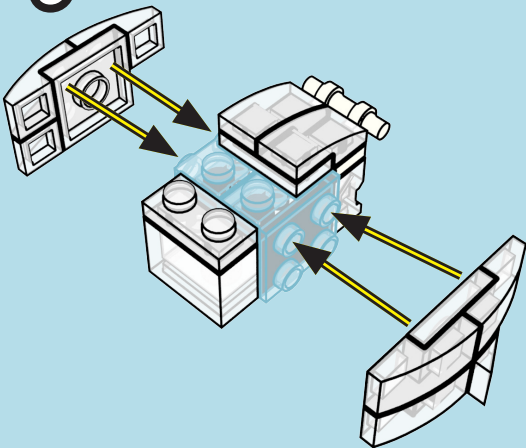

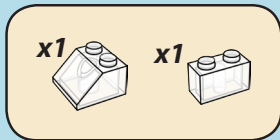

7

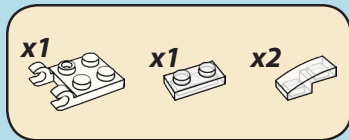
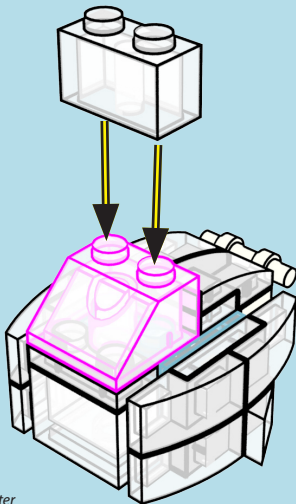

8

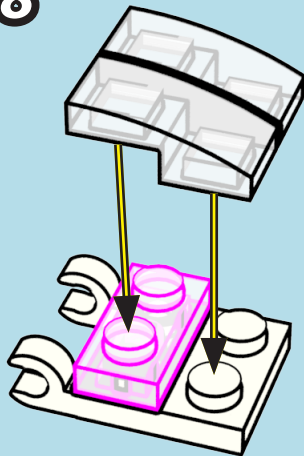

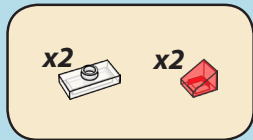
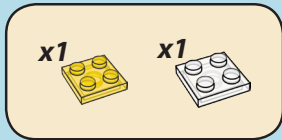

9

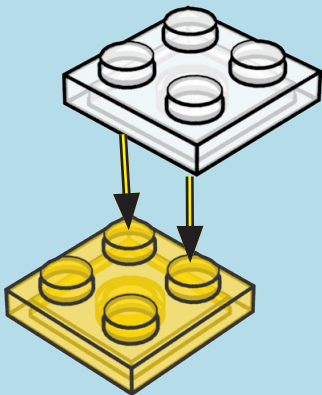

10



11

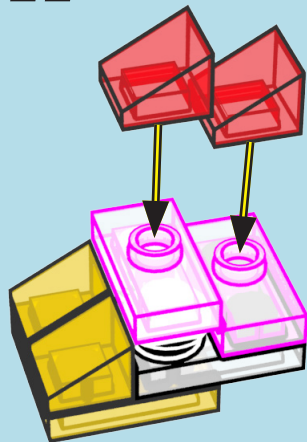

12

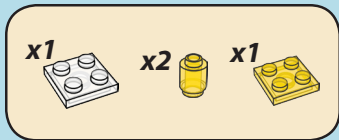
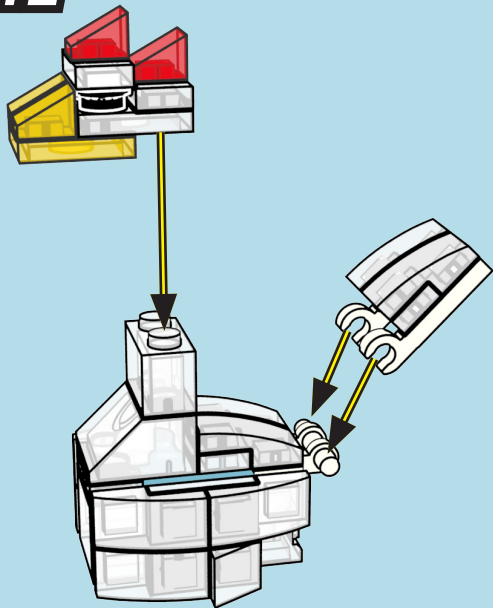

13

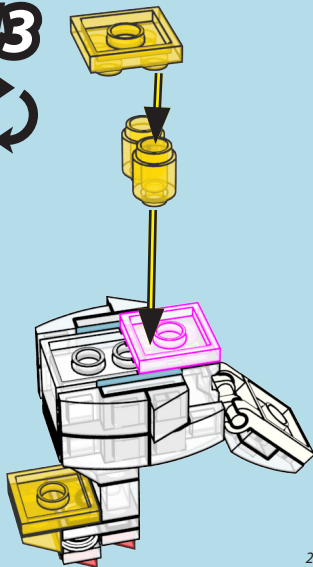



Questions?? Go to: laserpegs.com/support
Des questions?? Allez à: laserpegs.com/support

16



14

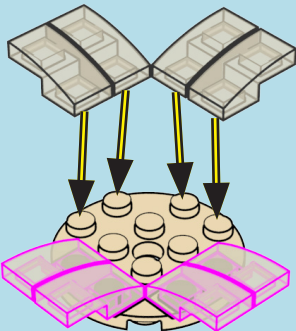

15

