

**GRUPA
topex**



ELEKTRONARZĘDZIA I AKCESORIA
POWER TOOLS AND ACCESSORIES ЭЛЕКТРОИНСТРУМЕНТЫ И АКСЕССУАРЫ





GRUPA
topex



Wielkość produktów w tym katalogu promują nasi pracownicy, bo Grupa TOPEX to przede wszystkim ludzie.

Most of the people, portrayed in the pictures in this catalogue, who are using our tools are the employees of the Grupa TOPEX, because we believe that our company is all about people.

Большинство продуктов в этом каталоге рекламируются нашими сотрудниками, потому что Grupa TOPEX – это в первую очередь люди.



Katalog elektronarzędzi i akcesoriów 2021/2022 Catalogue of power tools and accessories 2021/2022

Szanowni Państwo,

z dużą satysfakcją oddajemy w Państwa ręce nowe wydanie naszego katalogu produktowego, zawierającego elektronarzędzia i akcesoria. Głęboko wierzymy, że po raz kolejny spotka się on z Państwa uznaniem. Dołożyliśmy wszelkich starań, aby ta publikacja była przyjaznym i skutecznym narzędziem w Państwa rękach.

Z życzeniami powodzenia w biznesie,

Dear Customers,

It is with great satisfaction that we present to you the new edition of our product catalogue containing power tools and accessories. We firmly believe that it will once again meet with your appreciation. We have done our best to make this publication a user-friendly and effective tool in your hands.

Good luck in business,

Piotr Potowski
Dyrektor Generalny
General Manager





Działamy na ponad 40 rynkach zagranicznych.

We operate on over 40 foreign markets.

Мы ведем деятельность на более чем 40 зарубежных рынках.

Klienci to siła napędowa naszej firmy.
Współpracujemy z 4000 partnerów handlowych na całym świecie.

Our customers drive the operations of our Company.
We cooperate with 4,000 business partners around the world.

Клиенты – это движущая сила нашей компании.
Мы сотрудничаем с 4000 коммерческими партнерами по всему миру.

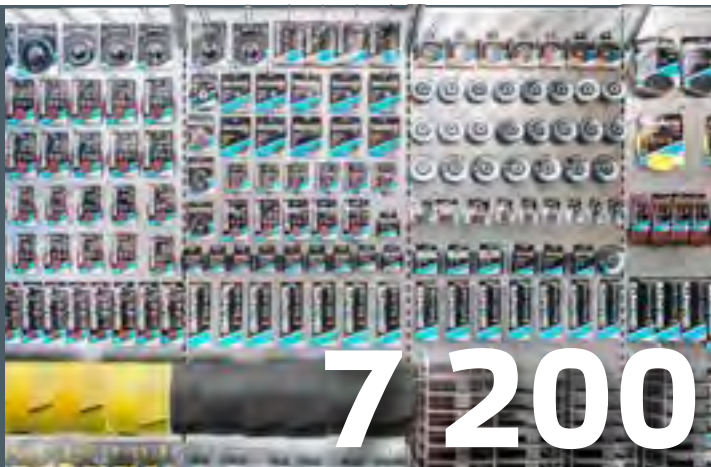

Nasza oferta produktowa to ponad 7200 pozycji asortymentowych.

Our product portfolio covers over 7200 articles.

Наше предложение включает около 7200 ассортиментных позиций.

Zarządzamy portfelem 5 marek produktowych:
NEO TOOLS, GRAPHITE, VERTO, TOPEX, TOP TOOLS.

We manage a portfolio covering 5 product brands:
NEO TOOLS, GRAPHITE, VERTO, TOPEX, TOP TOOLS.

Мы управляем портфелем из 5 продуктовых брендов:
NEO TOOLS, GRAPHITE, VERTO, TOPEX, TOP TOOLS.





TÜV ISO 9001:2015

Nasz system zarządzania jakością w Dziale Technicznym posiada certyfikat zgodności z jedną z najważniejszych norm dotyczących kontroli jakości ISO 9001:2015.

Our Quality Management System implemented within the Technical Department has been certified as compliant with one of the most important standards pertaining to quality inspection, namely ISO 9001:2015.

Наша система менеджмента качества в Техническом отделе имеет сертификат соответствия одному из самых важных стандартов, касающихся контроля качества - ISO 9001:2015.

Wyróżnia nas jakość. Nasze laboratorium prowadzi ponad 100 różnych badań jakościowych opartych o Normy Europejskie dla około 300 grup produktowych.

Quality is what distinguishes us from others. Our laboratory carries out more than 100 different qualitative tests based on European standards, covering approximately 300 product groups.

Нас отличает качество. Наша лаборатория проводит свыше 100 различных исследований в соответствии с европейскими стандартами для ок. 300 групп продуктов.



Ponad 600 naszych pracowników dba o właściwy poziom obsługi naszych partnerów handlowych.

More than 600 of our employees care for the right level of our business partner service level.

Более 600 сотрудников заботятся о надлежащем уровне обслуживания наших коммерческих партнеров.

Biznes nie kończy się na realizacji zamówienia. Stałą dostępność części zamiennych do naszych produktów oraz profesjonalny serwis gwarancyjny i pogwarancyjny zapewnią GTX Service.

Business does not end with order fulfillment. Ongoing availability of spare parts for our products, and professional warranty and non-warranty services are provided by GTX Service.

Бизнес не заканчивается выполнением заказа. GTX Service обеспечивает постоянную доступность запасных частей к нашим продуктам а также профессиональное гарантийное и постгарантийное обслуживание GTX Service.



UŁATWIAMY ŻYCIE LUDZIOM, KTÓRZY UŻYWAJĄ NARZĘDZI.
WE MAKE LIFE EASIER FOR PEOPLE WHO USE TOOLS.
ОБЛЕГЧАЕМ ЖИЗНЬ ВСЕМ, КТО ПОЛЬЗУЕТСЯ ИНСТРУМЕНТОМ.

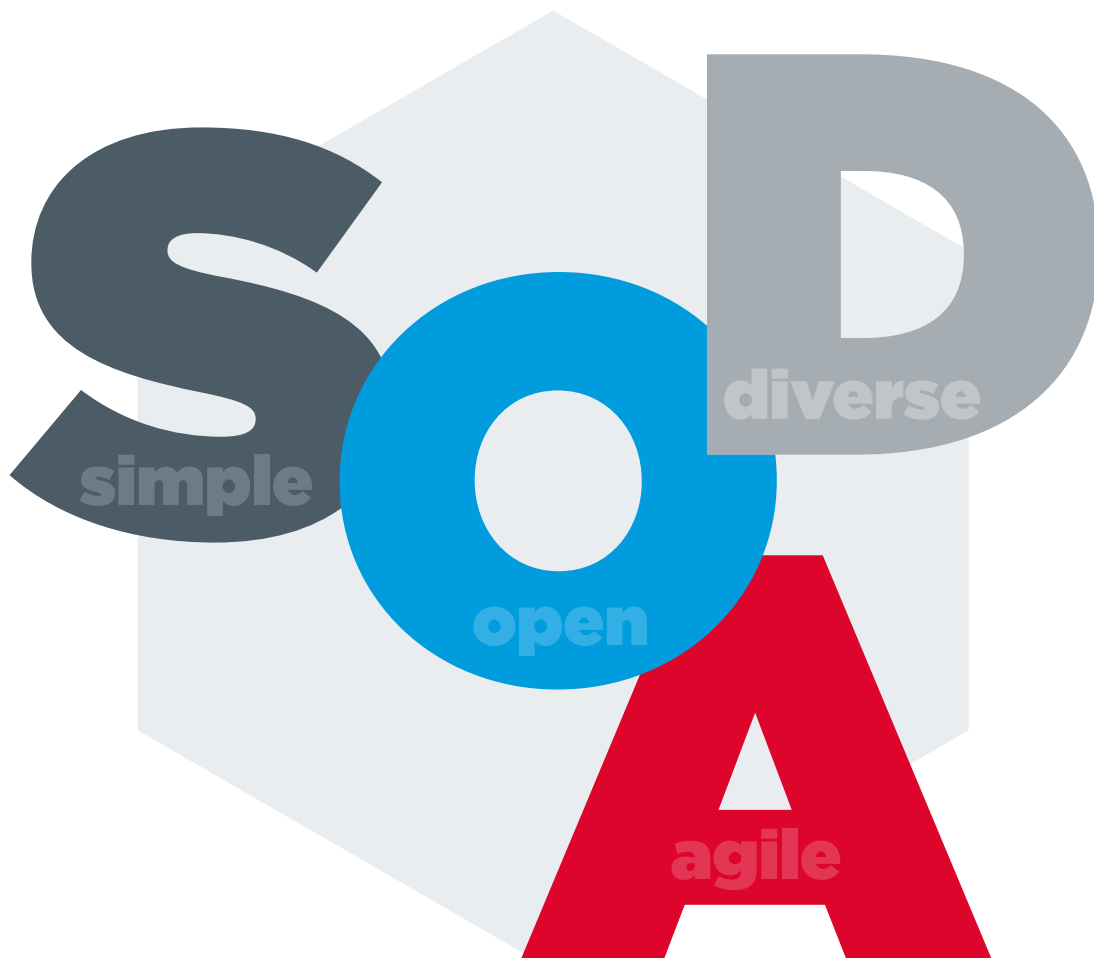

UPRASZCZANIE
SIMPLE
УПРОЩЕНИЕ

Maksymalne uproszczenie wszelkich podejmowanych działań poprzez kulturę poszukiwania prostszych rozwiązań.

Maximum simplification of any action taken through a culture of seeking simpler solutions and openness to a certain level of risk and imperfection.

Максимально упростить все предпринимаемые действия посредством культуры поиска самых простых решений.

OTWARTOŚĆ
OPEN
ОТКРЫТОСТЬ

Otwarta komunikacja budowana poprzez otwarty styl zarządzania, wspierana żywą kulturą informacji zwrotnej.

Open communication in the team built through an open management style, supported by a vibrant culture of feedback.

Открытая коммуникация, выстраиваемая благодаря открытому стилю управления и культуре качественной обратной связи.

RÓŻNORODNOŚĆ
DIVERSE
РАЗНООБРАЗИЕ

Zróżnicowanie pod każdym względem, zarówno w zakresie działań biznesowych jak i zespołu.

Diversity in every aspect, either in terms of business activities or team.

Дифференцированный подход, как в работе с бизнес-партнерами, так и внутри коллектива.

ELASTYCZNOŚĆ
AGILE
ЭЛАСТИЧНОСТЬ

Dostosowanie się do otoczenia i orientacja na faktyczne i aktualne potrzeby rynku.

Agile, adaptation to the environment and orientation to the current and actual market needs.

Подстраиваемся под окружение, ориентируемся на реальные и актуальные потребности рынка.

ZOBACZ RÓWNIEŻ KATALOG NARZĘDZI RĘCZNYCH

SEE ALSO THE CATALOG OF HAND TOOLS

СМОТРИТЕ ТАКЖЕ КАТАЛОГ
РУЧНОГО ИНСТРУМЕНТА

NEO
TOOLS

TOPEX

VERTO

TOP TOOLS



Szczypce
Dekoratorskie
Klucze i wkrętaki
Oświetlenie
Survival
Dom i garaż
BHP
Łączące
Transport i magazynowanie
Pomiarowe
Pneumatyka
Budowlane
Mechaniczne
Motoryzacyjne

Pliers
Decorating
Wrenches and screwdrivers
Lighting
Survival
House and garage
OHS
Joining
Transportation and storage
Measuring
Pneumatics
Building
Mechanical
Automotive tools

Щипцы
Отделочные
Ключи и отвертки
Освещение
Выживание
Дом и гараж
СИЗ
Соединительные
Транспортировка и хранение
Измерительные
Пневматический инструмент
Строительные
Механическое
Автомаскерское

**ELEKTRONARZĘDZIA
POWER TOOLS
ЭЛЕКТРОИНСТРУМЕНТЫ**

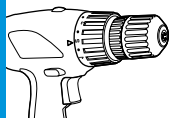

14



16



17



18



19



22



23



24



25



26



27



28



30



32



33



35



36



37



38



40



44



45



46



47



50



51



52



53



54



56



57



58



59



61



62



**AKCESORIA
ACCESSORIES
ПРИНАДЛЕЖНОСТИ
К ЭЛЕКТРОИНСТРУМЕНТАМ**

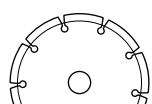

63



67



68



74



78



80



82



86



88



91



96

**ELEKTRONARZĘDZIA
POWER TOOLS
ЭЛЕКТРОИНСТРУМЕНТЫ**

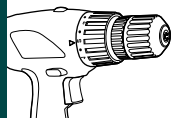

101



102



103



104



106



107



108



109



110



111



111



111



112



112



113



113



114

**AKCESORIA
ACCESSORIES
ПРИНАДЛЕЖНОСТИ
К ЭЛЕКТРОИНСТРУМЕНТАМ**

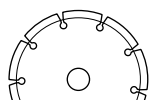

115



117



118



119



121



123



127



129



130



130



131

**AKCESORIA
ACCESSORIES
ПРИНАДЛЕЖНОСТИ
К ЭЛЕКТРОИНСТРУМЕНТАМ**



132



133



133



133



133

**AKCESORIA
ACCESSORIES
ПРИНАДЛЕЖНОСТИ
К ЭЛЕКТРОИНСТРУМЕНТАМ**

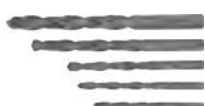

134



135



135



135



135

GRAPHITE

POWER IN YOUR HANDS

3
YEARS
WARRANTY



10^{*}
YEARS
SPARE PARTS
AVAILABILITY

* części zamienne dostępne na: gtxservice.pl

* spare parts available on: gtxservice.pl

* запасные части на: gtxservice.pl

Marka **GRAPHITE** zapewnia pełną dostępność części zamiennych oraz materiałów eksploatacyjnych dla urządzeń i elektronarzędzi. Dzięki temu urządzenia mogą być sprawne przez długi czas.

We ensure constant availability of spare parts and consumable materials for devices and power tools. Therefore, the **GRAPHITE** power tools stay operational for years.

Обеспечиваем постоянную доступность запасных частей и расходных материалов для оборудования и электроинструмента. Благодаря этому электроинструмент **GRAPHITE** остается исправным в течение долгих лет.

GRAPHITE to:

- ▶ szeroki asortyment wysokiej jakości elektronarzędzi i akcesoriów
- ▶ ważny i wiodący element marki stanowi system Energy+
- ▶ elektronarzędzia przeznaczone do intensywnego użytkowania, przy obciążeniach bliskich profesjonalnym
- ▶ produkty z optymalnym zestawem cech: wytrzymałe, ergonomiczne, o mocnych silnikach

GRAPHITE is:

- ▶ a wide range of high quality power tools and accessories
- ▶ an important and leading element of the brand is the Energy+ System
- ▶ power tools designed for intensive semi-professional use
- ▶ products with optimum set of features: durable, ergonomic, with powerful motors

GRAPHITE это:

- ▶ широкий ассортимент высококачественного электроинструмента и принадлежностей к нему
- ▶ важным и ведущим элементом бренда является система Energy +
- ▶ электроинструмент, предназначенный для интенсивного использования при нагрузках, приближенных к профессиональным
- ▶ продукты с оптимальным набором качеств: прочные, с мощными двигателями и эргономичной конструкцией

ZAPRASZAMY NA KANAŁY MARKI GRAPHITE W MEDIACH SPOŁECZNOŚCIOWYCH

COME AND BROWSE GRAPHITE SOCIAL MEDIA CHANNELS

ПРИГЛАШАЕМ НА КАНАЛЫ МАРКИ GRAPHITE В СОЦИАЛЬНЫХ СЕТЯХ



GRAPHITE

Informacje o nowościach produktowych, porady oraz VIDEO



Information on new products, advice and VIDEOS

Информация о новых продуктах, советы и ВИДЕО



GRAPHITEmov

VIDEO produktowe, porównania i testy produktów w wielu wersjach językowych



Product related VIDEOS, product comparisons and tests in multiple language versions

ВИДЕО о продуктах, сравнение и тесты продуктов в различных языковых версиях



QR-code obok produktu to dedykowane dla niego części zamienne

Scan the QR code to purchase spare parts for each GRAPHITE tool

QR-код рядом с продуктом посвящен запасным к нему частям

graphite.pl

Nasze wieloletnie doświadczenie i znajomość rynku elektronarzędzi pomogła nam w opracowaniu rozwiązań ekspozycji produktów, które wspierają naszych partnerów handlowych w codziennym biznesie.

- **unikalność** - regały dedykowane dla marki GRAPHITE (elektronarzędzia i akcesoria)
- **solidność** - konstrukcje wykonane z dobrej jakości materiałów
- **nowoczesność** - ciekawe rozwiązanie na komunikację o produktach, markach, akcjach promocyjnych
- **uniwersalność** - odpowiednie dopasowanie do ilości miejsca w sklepie

Many years of experience and knowledge of tool market allowed us to develop solutions for product exposition, which create a great support in everyday business for our trade partners.

- **unique features** - cabinets dedicated for GRAPHITE brand (power tools and accessories)
- **reliability** - designs include good quality materials
- **modern design** - interesting solution for communication about products, brands, promotional events
- **versatility** - matching to space available in a shop

Благодаря нашему многолетнему опыту и знанию рынка инструмента, мы разработали решения по эффективной презентации товаров, которые помогают нашим коммерческим партнерам в их повседневной работе

- **уникальность** - стеллажи, предназначенные для бренда GRAPHITE (электроинструмента и принадлежностей)
- **прочность** - конструкции изготовлены из материалов хорошего качества
- **современность** - интересные решения по маркетинговой коммуникации - о товарах, брендах, промо-акциях
- **универсальность** - специальные решения с учетом площади магазина

OFERTA SZYTA NA MIARĘ

TAILORED-MADE OFFER

ОФЕРТА ПОД ЗАКАЗ



GRAPHITE

ENERGY+
system



System Energy+

System Energy+ to linia produktów zasilanych akumulatorami tego samego typu. Dzięki takiemu rozwiązaniu istnieje możliwość dowolnej konfiguracji zestawu produktów i doboru optymalnej ilości potrzebnych akumulatorów.

Energy+ System

Energy+ System is the range of products powered with batteries of the same type. This solution allows to configure set of products at will and choose optimal number of required batteries.

Система Energy+

Система Energy+ это новая линейка продуктов с питанием от аккумуляторных батарей одного и того же типа. Благодаря такому решению можно по собственному усмотрению сконфигурировать набор инструмента и подобрать нужное количество аккумуляторных батарей.



JEDEN akumulator
WIELE możliwości

ONE battery
MANY possibilities

ОДНА аккумуляторная батарея
МНОЖЕСТВО возможностей

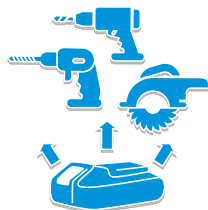

**KOMPATYBILNY
COMPATIBILITY
СОВМЕСТИМАЯ**

możliwość współdzielenia akumulatorów przez różne typy elektronarzędzi

batteries can be shared among various types of power tools

возможность использования аккумуляторных батарей для работы с разными типами электроинструмента



**MOBILNY
MOBILITY
МОБИЛЬНАЯ**

nieograniczone przewodem zasilającym operowanie urządzeniem

power tool operation unrestricted by power cord

работа с электроинструментом, не ограниченная шнуром питания



**WYDAJNY
EFFICIENCY
ЭФФЕКТИВНАЯ**

możliwość ładowania akumulatora w dowolnej chwili bez ryzyka utraty jego pojemności

the battery can be charged at any moment, without risk of degrading

зарядка аккумулятора возможна в любой момент, без риска потери его емкости



**WYTRZYMAŁY
DURABILITY
НАДЕЖНАЯ**

wysokiej jakości materiały i wytrzymałe podzespoły

high quality materials and long lasting components

высококачественные материалы и надежные комплектующие



**KOMFORT PRACY
COMFORT AT WORK
КОМФОРТ РАБОТЫ**

ergonomiczna konstrukcja i nowoczesne wzornictwo

ergonomic and modern design

эргономичная конструкция и современный дизайн

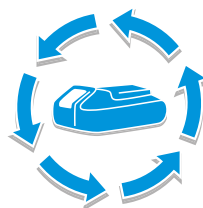

**UNIERSALNY
VERSATILITY
УНИВЕРСАЛЬНАЯ**

dowolność i łatwość zestawienia elektronarzędzia z akumulatorem

power tool can be freely and easily matched with battery

неограниченный и простой подбор аккумуляторной батареи к инструменту



JEDEN akumulator
WIELE możliwości

ONE battery
MANY possibilities

ОДНА аккумуляторная батарея
МНОЖЕСТВО возможностей

GRAPHITE

BRUSHLESS

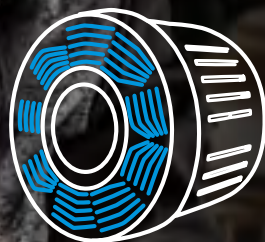

Silnik bezszczotkowy
Brushless motor
Вентильный
электродвигатель

ZALETY URZĄDZEŃ Z SILNIKAMI BEZSZCZOTKOWYMI:

- ▶ większa moc w bardziej zwartej, krótszej konstrukcji
- ▶ najwyższy moment obrotowy już przy minimalnych obrotach
- ▶ precyzyjne, elektroniczne sterowanie prędkością silnika
- ▶ podtrzymanie prędkości pracy także pod obciążeniem

ADVANTAGES OF DEVICES WITH BRUSHLESS ENGINES:

- ▶ more power in a more compact, shorter construction
- ▶ maximum torque already at minimal revs
- ▶ precise, electronic engine speed control
- ▶ maintaining work speed also under load

ПРЕИМУЩЕСТВА УСТРОЙСТВ С БЕСЩЕТОЧНЫМИ ДВИГАТЕЛЯМИ:

- ▶ больше мощности в более компактной конструкции
- ▶ максимальный крутящий момент уже при минимальных оборотах
- ▶ точное электронное управление частотой вращения двигателя
- ▶ поддержание скорости работы также при нагрузке

ZALETY SYSTEMU 36V ENERGY +

- ▶ moc urządzeń sieciowych przy zachowaniu mobilności urządzeń akumulatorowych
- ▶ kompatybilność z akumulatorami Energy+ 18V
- ▶ możliwość dostosowania wagi urządzenia poprzez wybór odpowiedniej pojemności akumulatorów

ADVANTAGES OF ENERGY+ 36V SYSTEM

- ▶ power of corded and mobility of cordless devices
- ▶ compatibility with Energy+ 18V batteries
- ▶ the ability to adjust the weight of the device by choosing the appropriate battery capacity

ПРЕИМУЩЕСТВА СИСТЕМЫ ENERGY+ 36V

- ▶ сила сетевых устройств при сохранении мобильности аккумуляторных
- ▶ совместимость с батареями Energy+ 18V
- ▶ возможность регулировки веса устройства, подбирая соответствующую емкость аккумулятора



GRAPHITE

ENERGY+
system

Wiertarko-wkrętarka akumulatorowa ENERGY+

Cordless drill / Akkubohrschrauber / Дрель-шуруповерт аккумуляторная / Дрель-шуруповерт аккумуляторный / Akkus fűró / Bormasina-surubelnita cu acumulator / Akumulátorová vrtáčka-šroubovák / Akumulátorový vrtací skrutkovač / Akumulatorski vrtalnik-vijačnik / Akumulátorinis gręžtuvas - suktuvas / Akumulatora urbmašina-skřuvgręzieis / Akutrell / Аккумуляторен пробивен винмоверт / Akumulatorska bušilica - izvijač / Akumulatorska bušilica - odvijač / Εναρφορτιζόμενο βρανανο-κατάβιδο / Taladradora atomilladora a batería / Trapano avvitatore a batteria / Aparafuradora de batería / Perceuse-visseuse à batterie / Accu boor-draaimachine

Ref. 58G000

18V
Li-Ion

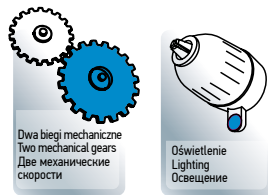

Dwa biegi mechaniczne
Two mechanical gears
Две механические скорости

Oświetlenie
Lighting
Освещение



WYDAJNOŚĆ / EFFICIENCY / ПРОИЗВОДИТЕЛЬНОСТЬ

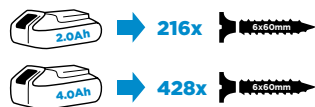

części zamienne
spare parts / запчасти

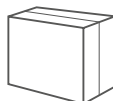

Dane techniczne	Specifications	Технические условия	
napięcie akumulatora	battery voltage	напряжение на аккумуляторе	18V DC
zakres prędkości obrotowej na biegu jałowym	range of idle rotational speed	диапазон частоты вращения на холостом ходу	0-350 min ⁻¹ 0-1250 min ⁻¹
zakres uchwytu szybkoocucującego	range of quick release chuck	рабочий диапазон быстрозажимного патрона	0.8-10 mm
zakres regulacji momentu obrotowego	torque control range	диапазон регулировки крутящего момента	1 - 19 + drilling
max. moment obrotowy (wkręcanie miękkie)	max. torque (soft drive)	макс. крутящий момент («мягкое» ввинчивание)	28 Nm
max. moment obrotowy (wkręcanie twarde)	max. torque (hard drive)	макс. крутящий момент («твердое» ввинчивание)	44 Nm
waga	weight	вес	1.1 kg
EAN	EAN	EAN	5902062035288

Ref. 58G022

18V
Li-Ion



Szybkowyjmnienny uchwyt
Quick chuck
Быстрозажимный патрон

Gniazdo na bity
Hex socket
Патрон для бит

Oświetlenie
Lighting
Освещение



WYDAJNOŚĆ / EFFICIENCY / ПРОИЗВОДИТЕЛЬНОСТЬ

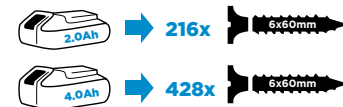

części zamienne
spare parts / запчасти

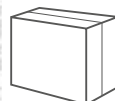

Dane techniczne	Specifications	Технические условия	
napięcie akumulatora	battery voltage	напряжение на аккумуляторе	18V DC
zakres prędkości obrotowej na biegu jałowym	range of idle rotational speed	диапазон частоты вращения на холостом ходу	0-350 min ⁻¹ 0-1250 min ⁻¹
zakres uchwytu szybkoocucującego	range of quick release chuck	рабочий диапазон быстрозажимного патрона	0.8-10 mm
zakres regulacji momentu obrotowego	torque control range	диапазон регулировки крутящего момента	1 - 19 + drilling
max. moment obrotowy (wkręcanie miękkie)	max. torque (soft drive)	макс. крутящий момент («мягкое» ввинчивание)	28 Nm
max. moment obrotowy (wkręcanie twarde)	max. torque (hard drive)	макс. крутящий момент («твердое» ввинчивание)	44 Nm
waga	weight	вес	1.1 kg
EAN	EAN	EAN	5902062045973

Ref. 58G022-AD

18V
Li-Ion

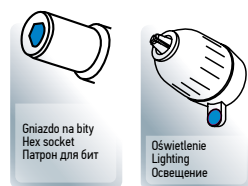

Gniazdo na bity
Hex socket
Патрон для бит

Oświetlenie
Lighting
Освещение



WYDAJNOŚĆ / EFFICIENCY / ПРОИЗВОДИТЕЛЬНОСТЬ

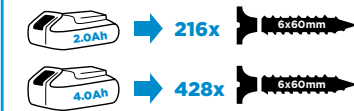

części zamienne
spare parts / запчасти

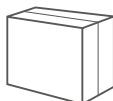

Dane techniczne	Specifications	Технические условия	
napięcie akumulatora	battery voltage	напряжение на аккумуляторе	18V DC
zakres prędkości obrotowej na biegu jałowym	range of idle rotational speed	диапазон частоты вращения на холостом ходу	0-350 min ⁻¹ 0-1250 min ⁻¹
zakres uchwytu szybkoocucującego	range of quick release chuck	рабочий диапазон быстрозажимного патрона	0.8-10 mm
zakres regulacji momentu obrotowego	torque control range	диапазон регулировки крутящего момента	1 - 19 + drilling
max. moment obrotowy (wkręcanie miękkie)	max. torque (soft drive)	макс. крутящий момент («мягкое» ввинчивание)	28 Nm
max. moment obrotowy (wkręcanie twarde)	max. torque (hard drive)	макс. крутящий момент («твердое» ввинчивание)	44 Nm
waga	weight	вес	1.1 kg
EAN	EAN	EAN	5902062065339

Ref. 58G006

18V
Li-Ion



Dwa biegi mechaniczne
Two mechanical gears
Две механические скорости

Wysoki moment obrotowy
High torque
Высокий вращающийся момент



WYDAJNOŚĆ / EFFICIENCY / ПРОИЗВОДИТЕЛЬНОСТЬ

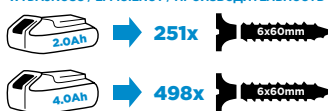

części zamienne
spare parts / запчасти

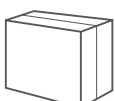

Dane techniczne	Specifications	Технические условия	
napięcie akumulatora	battery voltage	напряжение на аккумуляторе	18V DC
zakres prędkości obrotowej na biegu jałowym	range of idle rotational speed	диапазон частоты вращения на холостом ходу	0-350 min ⁻¹ 0-1250 min ⁻¹
zakres uchwytu szybkoocucującego	range of quick release chuck	рабочий диапазон быстрозажимного патрона	2-13 mm
zakres regulacji momentu obrotowego	torque control range	диапазон регулировки крутящего момента	1 - 19 + drilling
max. moment obrotowy (wkręcanie miękkie)	max. torque (soft drive)	макс. крутящий момент («мягкое» ввинчивание)	35 Nm
max. moment obrotowy (wkręcanie twarde)	max. torque (hard drive)	макс. крутящий момент («твердое» ввинчивание)	55 Nm
waga	weight	вес	1.3 kg
EAN	EAN	EAN	5902062035349

Wiertarko-wkrętarka akumulatorowa ENERGY+

Cordless drill / Akkubohrschrauber / Дрель-шуруповерт аккумуляторная / Дрель-шуруповерт аккумуляторный / Akkus fűró / Bormasina-surubelnita cu acumulator / Akumulátorový vrtáček / Akumulátorový vrtáček / Akumulátorini grežtuvas - suktuvas / Akumulatora urbmašina-skrūvgriezis / Akutrell / Аккумуляторен пробивен винтоверт / Akumulatorska bušilica - izvijač / Akumulatorska bušilica - odvijač / Εναρτηζόμενο βραπνο-κατόβιο / Taladradora atomilladora a batería / Trapano avvitatore a batteria / Aparafuradora de batería / Perceuse-visseuse à batterie / Accu boor-draaimachine

Ref. 58G010

18V
Li-Ion

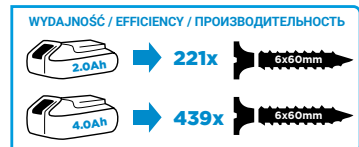
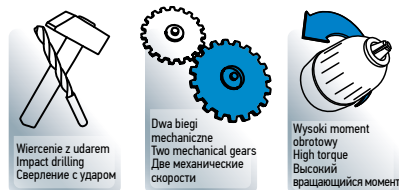

Dane techniczne	Specifications	Технические условия	
napięcie akumulatora	battery voltage	напряжение на аккумуляторе	18V DC
zakres prędkości obrotowej na biegu jałowym	range of idle rotational speed	диапазон частоты вращения на холостом ходу	0-350 min ⁻¹ 0-1250 min ⁻¹
częstotliwość udera na biegu jałowym	impact speed on idle	частота удара на холостом ходу	0-5250 min ⁻¹ 0-18750 min ⁻¹
zakres uchwytu szybkomocującego	range of quick release chuck	рабочий диапазон быстрозажимного патрона	2-13 mm
zakres regulacji momentu obrotowego	torque control range	диапазон регулировки крутящего момента	1 – 16 + drilling + impact drilling
max. moment obrotowy (wkręcanie miękkie)	max. torque (soft drive)	макс. крутящий момент («мягкое» ввинчивание)	35 Nm
max. moment obrotowy (wkręcanie twarde)	max. torque (hard drive)	макс. крутящий момент («твердое» ввинчивание)	55 Nm
waga	weight	вес	1.3 kg
EAN	EAN	EAN	5902062035387

Ref. 58G019

18V
Li-Ion

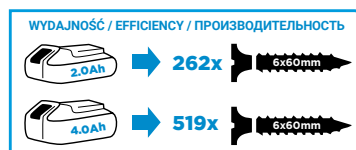

Dane techniczne	Specifications	Технические условия	
napięcie akumulatora	battery voltage	напряжение на аккумуляторе	18V DC
zakres prędkości obrotowej na biegu jałowym	range of idle rotational speed	диапазон частоты вращения на холостом ходу	0-500 min ⁻¹ 0-1700 min ⁻¹
zakres uchwytu szybkomocującego	range of quick release chuck	рабочий диапазон быстрозажимного патрона	2-13 mm
zakres regulacji momentu obrotowego	torque control range	диапазон регулировки крутящего момента	1 – 16 + drilling
max. moment obrotowy (wkręcanie miękkie)	max. torque (soft drive)	макс. крутящий момент («мягкое» ввинчивание)	38 Nm
max. moment obrotowy (wkręcanie twarde)	max. torque (hard drive)	макс. крутящий момент («твердое» ввинчивание)	58 Nm
waga	weight	вес	1.2 kg
EAN	EAN	EAN	5902062045942

Ref. 58G020

18V
Li-Ion

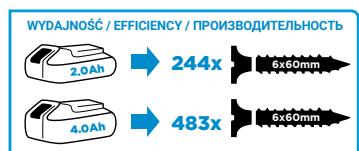

Dane techniczne	Specifications	Технические условия	
napięcie akumulatora	battery voltage	напряжение на аккумуляторе	18V DC
zakres prędkości obrotowej na biegu jałowym	range of idle rotational speed	диапазон частоты вращения на холостом ходу	0-500 min ⁻¹ 0-1700 min ⁻¹
częstotliwość udera na biegu jałowym	impact speed on idle	частота удара на холостом ходу	0-7500 min ⁻¹ 0-25500 min ⁻¹
zakres uchwytu szybkomocującego	range of quick release chuck	рабочий диапазон быстрозажимного патрона	2-13 mm
zakres regulacji momentu obrotowego	torque control range	диапазон регулировки крутящего момента	1 – 16 + drilling + impact drilling
max. moment obrotowy (wkręcanie miękkie)	max. torque (soft drive)	макс. крутящий момент («мягкое» ввинчивание)	38 Nm
max. moment obrotowy (wkręcanie twarde)	max. torque (hard drive)	макс. крутящий момент («твердое» ввинчивание)	58 Nm
waga	weight	вес	1.2 kg
EAN	EAN	EAN	5902062045959

Klucz udarowy akumulatorowy ENERGY+

Impact wrench / Schlagschlüssel / Ключ ударный / Мутроверт ударный / Útvecsavarozó / Cheie cu percutie / Rázový utahovák / Prikleповý ključ / Udarni vijčačnik / Atskélimo plaktukas / Sitama atslēga / Löökvõti / Ударен ключ / Udarni ključ / Pneumatski ključ / Κλειδί κρούσης / Llave de impacto / Avvitatore ad impulsi / Chave de impacto / Clef à chocs / Slagsleutel

Ref. 58G018

18V
Li-Ion

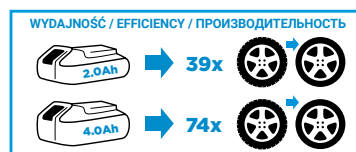
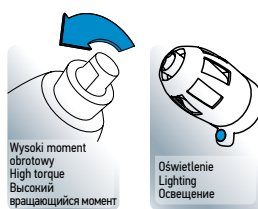

Dane techniczne	Specifications	Технические условия	
napięcie akumulatora	battery voltage	напряжение на аккумуляторе	18V DC
zakres prędkości obrotowej na biegu jałowym	range of idle rotational speed	диапазон частоты вращения на холостом ходу	0-2200 min ⁻¹
uchwyt narzędziowy	tool chuck	патрон	1/2"
max. moment obrotowy (wkręcanie twarde)	max. torque (hard drive)	макс. крутящий момент («твердое» ввинчивание)	180 Nm
waga	weight	вес	1.8 kg
EAN	EAN	EAN	5902062045935

10*
YEARS
SPARE PARTS
AVAILABILITY

* Części zamienne dostępne na: gtxservice.pl
* Spare parts available on: gtxservice.pl
* Запасные части на: gtxservice.pl

@GRAPHITE

GRAPHITEmov

graphite.pl

Zakrętarka akumulatorowa ENERGY+

Cordless driver / Akku-Schraubmaschine / Гайковерт аккумуляторный / Мутроверт аккумуляторный / Akkus ütvesszarozó / Inchizator de acumulator / Akumulátorový šroubovák / Akumulátorový šroubovák / Akumulatorski vrtalnik / Akumuliatorinis suktuvas / Akumulatora uzvāznis / Keertpuur / Ударен гайковерт / Akumulatorski zavijač / Akumulatorski navojni čep / Εναρφαορτιζόμενο καταβίδι / Dispositivo de cierre a batería / Avvitatore a batteria ad impulsi / Máquina de travar com bateria / Visseuse à batterie / Accu schroefmachine

Ref. 58G012

18V
Li-Ion

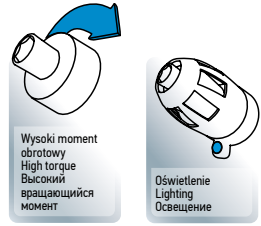

WYDAJNOŚĆ / EFFICIENCY / ПРОИЗВОДИТЕЛЬНОСТЬ

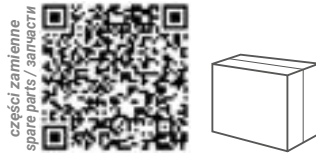
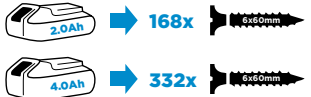

Dane techniczne	Specifications	Технические условия
napięcie akumulatora	battery voltage	напряжение на аккумуляторе
zakres prędkości obrotowej na biegu jałowym	range of idle rotational speed	диапазон частоты вращения на холостом ходу
uchwyt narzędziowy	tool chuck	патрон
max. moment obrotowy	max. torque	макс. крутящий момент
waga	weight	вес
EAN	EAN	EAN

Ref. 58G024

18V
Li-Ion

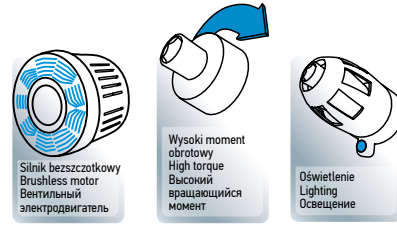

WYDAJNOŚĆ / EFFICIENCY / ПРОИЗВОДИТЕЛЬНОСТЬ

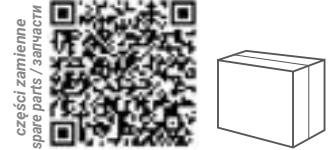
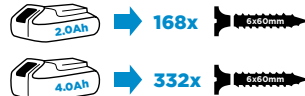

Dane techniczne	Specifications	Технические условия
napięcie akumulatora	battery voltage	напряжение на аккумуляторе
zakres prędkości obrotowej na biegu jałowym	range of idle rotational speed	диапазон частоты вращения на холостом ходу
częstotliwość udera na biegu jałowym	impact speed on idle	частота удара на холостом ходу
uchwyt narzędziowy	tool chuck	патрон
max. moment obrotowy	max. torque	макс. крутящий момент
waga	weight	вес
EAN	EAN	EAN

Młotowiertarka akumulatorowa ENERGY+

Cordless rotary hammer drill / Akku-Hammerbohrmaschine / Перфоратор аккумуляторный / Перфоратор аккумуляторный / Akkus fúrákalapács / Borasina percutanta cu acumulator / Vrtací kladivo akumulátorové / Akumulátorové vrtacie kladivo / Baterijsko vrtalno kladivo / Akumuliatorinis perforatorius / Akumulatora perforators / Akuga lööktrell / Аккумуляторна ударна бормашина / Akumulatorski čekić-bušilica / Akumulatorska bušilica sa čekićem / Εναρφαορτιζόμενη σφύρα / Martillo-taladro a batería / Tassellatore / Martelo-Berbequim de bateria / Perceuse-marteau à batterie / Accu boorhamer

58G009

18V
Li-Ion

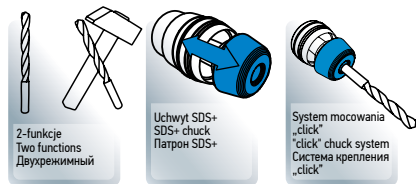

WYDAJNOŚĆ / EFFICIENCY / ПРОИЗВОДИТЕЛЬНОСТЬ

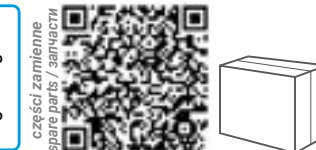
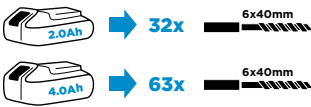

Dane techniczne	Specifications	Технические условия
napięcie akumulatora	battery voltage	напряжение на аккумуляторе
prędkość obrotowa	rotational speed	частота вращения
częstotliwość udera	impact rate	частота удара
energia udera	impact energy	энергия удара
uchwyt narzędziowy	tool chuck	патрон
klasa ochronności	protection class	класс защиты
waga	weight	вес
EAN	EAN	EAN

Ref. 58G027

18V
Li-Ion

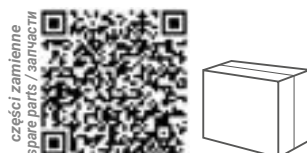

Dane techniczne	Specifications	Технические условия
napięcie akumulatora	battery voltage	напряжение на аккумуляторе
prędkość obrotowa	rotational speed	частота вращения
częstotliwość udera	impact rate	частота удара
energia udera	impact energy	энергия удара
uchwyt narzędziowy	tool chuck	патрон
maksymalna średnica wiercenia: drewno/stal/beton	maximum drilling diameter: wood/steel/concrete	максимальный диаметр сверления: древесина/сталь/бетон
klasa ochronności	protection class	класс защиты
waga	weight	вес
EAN	EAN	EAN

Szlifierka kątowa akumulatorowa ENERGY+

Cordless angle grinder / Winkelschleifer / Аккумуляторная угловая шлифовальная машина / Шліфмашина кутова (болгарка) / Akkus sarokcsiszoló / Masina de slefuit unghiulara / Uhlová bruska / Uhlová brúška / Kotni brusilnik / Kampinis šlijuoklis / Leŋka slīpmašīna / Nurklhviya / Ёлошлайф / Kutna brusilica / Ugaona brusilica / Γωνιακό τρίβειο / Amoladora angular / Smerigliatrice angolare / Disco de limar p. cantos / Meuleuse d'angle / Versteckschuurmachine

Ref. 58G003

18V
Li-Ion



Wąska obudowa
Narrow body
Узкий корпус



Dwustronny montaż uchwytu
Two-position handle
Двухпозиционная фиксация рукоятки

WYDAJNOŚĆ / EFFICIENCY / ПРОИЗВОДИТЕЛЬНОСТЬ

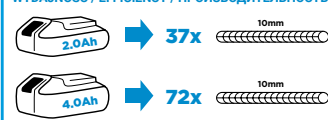

części zamienne
spare parts / запчасты

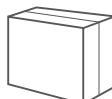

Dane techniczne	Specifications	Технические условия	
napięcie akumulatora	battery voltage	напряжение на аккумуляторе	18V DC
prędkość obrotowa	rotational speed	частота вращения	10000 min ⁻¹
max. średnica tarczy	maximum wheel diameter	макс. диаметр круга	115 mm
wewnętrzna średnica tarczy	inner wheel diameter	диаметр посадочного отверстия круга	22.2 mm
gwint wrzeciona	spindle thread	резьба шпинделя	M14
waga	weight	вес	1.5 kg
EAN	EAN	EAN	5902062035318

Urządzenie wielofunkcyjne akumulatorowe ENERGY+

Multi-function tool / Mehrfunktionsgerät / Многофункциональный инструмент / Багатофункційний пристрій / Többfunkciós berendezés / Dispozitiv multifuncțional / Multifunkční zařízení / Multifunkčné zariadenie / Večfunkcijska naprava / Daugiafunkcinis įrankis / Daudzfunkcionāla iekārta / Multifunktsionaalne seade / Мультифункционально устройство / Višenamjenski uređaj / Višefunkcionalni uređaj / Εργαλείο πολλαπλών χρήσεων / Dispositivo multifunción / Dispositivo multifunzione / Dipositivo multifuncional / Appareil multifonction / Multifunctioneel toestel

Ref. 58G013

18V
Li-Ion



Aluminiowy korpus
Aluminum body
Алюминиевый корпус

WYDAJNOŚĆ / EFFICIENCY / ПРОИЗВОДИТЕЛЬНОСТЬ

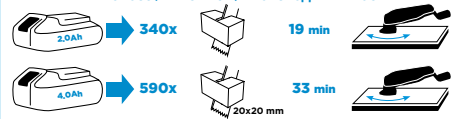

części zamienne
spare parts / запчасты

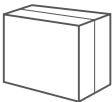

Dane techniczne	Specifications	Технические условия	
napięcie akumulatora	battery voltage	напряжение на аккумуляторе	18V DC
liczba oscylacji	idle oscillation speed	число колебаний	5000-20000 min ⁻¹
kąt oscylacji	Oscillation angle	Угол колебаний	3°
waga	weight	вес	1.8 kg
EAN	EAN	EAN	5902062035417

Ref. 58G026

18V
Li-Ion



Silnik bezszczotkowy
Brushless motor
Вентильный электродвигатель



Wąska obudowa
Narrow body
Узкий корпус

części zamienne
spare parts / запчасты

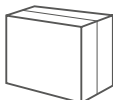

Dane techniczne	Specifications	Технические условия	
napięcie akumulatora	battery voltage	напряжение на аккумуляторе	18V DC
prędkość obrotowa	rotational speed	частота вращения	10000 min ⁻¹
max. średnica tarczy	maximum wheel diameter	макс. диаметр круга	125 mm
wewnętrzna średnica tarczy	inner wheel diameter	диаметр посадочного отверстия круга	22.2 mm
gwint wrzeciona	spindle thread	резьба шпинделя	M14
klasa ochronności	protection class	класс защиты	III
waga	weight	вес	1.7 kg
EAN	EAN	EAN	5902062059772

Szlifierka mimośrodowa akumulatorowa ENERGY+

Cordless orbital sander / Excenterschleifmaschine / Аккумуляторная эксцентриковая шлифовальная машина / Шліфмашина ексцентрикова / Akkus excentercsiszoló / Masina de slefuit excentrica / Excentrická bruska / Excentrická brúška / Ekscentrični brusilnik / Ekscentrinis šlijuoklis / Ekscentra slīpmašīna / Eksstentrikhviya / Шлайфмашина ексцентрична / Vibracijska bušilica / Ekscentrična brusilica / Экцентро τρίβειο / Lijadora excentrica / Levigatrice orbitale / Disco de limar / Meuleuse excentrique / Excenter schuurmachine

Ref. 58G014

18V
Li-Ion



Montaż papieru na rzep
Hook-and-loop fastening system
Крепление на липучке



System odprowadzania pyłu
Dust extraction system
Система пылеудаления

WYDAJNOŚĆ / EFFICIENCY / ПРОИЗВОДИТЕЛЬНОСТЬ

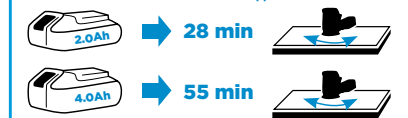

części zamienne
spare parts / запчасты

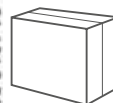

Dane techniczne	Specifications	Технические условия	
napięcie akumulatora	battery voltage	напряжение на аккумуляторе	18V DC
zakres prędkości obrotowej na biegu jałowym	range of idle rotational speed	диапазон частоты вращения на холостом ходу	5000/7000/9000 min ⁻¹
zakres oscylacji na biegu jałowym	range of idle oscillation speed	частота колебаний на холостом ходу	10000/14000/18000 min ⁻¹
amplituda oscylacji	oscillation amplitude	амплитуда колебаний	2.7 mm
wymiar stopy / papieru ściernego	size of sanding paper	размер шлифовальной бумаги	125 mm
waga	weight	вес	1.1 kg
EAN	EAN	EAN	5902062035424

10*
YEARS
SPARE PARTS
AVAILABILITY

* Części zamienne dostępne na: gtxservice.pl

* Spare parts available on: gtxservice.pl

* Запасные части на: gtxservice.pl

@GRAPHITE

GRAPHITEmov

graphite.pl

Wyrzynarka akumulatorowa ENERGY+

Cordless blade sawing machine / Schweifsäge / Аккумуляторная ножовочная пила / Лобзик / Akkus dekopirfűrés / Masina de decupat / Kmitaci pila / Priatočiara pila / Vhodna žaga / Sjaaragjūklis / Figūrzāģis / Tikksaag / Ажурна дървообработваща машина / Ubodna pila / (Ručna) testera / Σεγα / Sierra de calar / Seghetto alternativo / Máquina de entalhar / Scie sauteuse / Decoupeerzaag

Ref. 58G011

18V

Li-Ion



Aluminiowa baza
Aluminium base
Алюминиевое основание



Funkcja podrzynania
Pendulum function
Функция подрезки



Oświetlenie
Lighting
Освещение



Brzeszczyt typ T
T shank blades
T-образное полотно



WYDAJNOŚĆ / EFFICIENCY / ПРОИЗВОДИТЕЛЬНОСТЬ



10 m



20 m



części zamienne
spare parts / запчасти

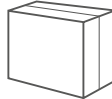

Dane techniczne	Specifications	Технические условия	
napięcie akumulatora	battery voltage	напряжение на аккумуляторе	18V DC
ilość cykli brzeszczotu (bez obciążenia)	blade stroke cycles (without load)	кол-во циклов полотна (без нагрузки)	0-2400 min ⁻¹
skok brzeszczotu	blade stroke length	шаг пильного полотна	25 mm
waga	weight	вес	1.7 kg
EAN	EAN	EAN	5902062035394



Pilarka szablowa akumulatorowa ENERGY+

Sabre saw / Motorstichsäge / Сабельная пила / Пилка шабельна / Szablyafűrés / Ferästräu sabie / Šavlová pila / Chvostová pila / Sabljasta žaga / Tiesinis pjūklas / Zobenzāģis / Saabelsaag / Саблен трион / Sabljasta pila / Sabljasta testera / Σταβόερα / Sierra de vaivén / Sega universale / Serra de sabre / Scie à sabre / Sabelzaag

Ref. 58G017

18V

Li-Ion

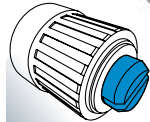

Beznarzędziowa
wymiana brzeszczotu
Toolless blade
replacement
Замена полотна без
инструментов



WYDAJNOŚĆ / EFFICIENCY / ПРОИЗВОДИТЕЛЬНОСТЬ



164x



313x



części zamienne
spare parts / запчасти

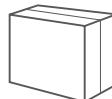

Dane techniczne	Specifications	Технические условия	
napięcie akumulatora	battery voltage	напряжение на аккумуляторе	18V DC
ilość obrotów	rpm	частота оборотов	0-3000 min ⁻¹
skok brzeszczotu	stroke length	ход полотна	22 mm
maksymalna grubość ciętego materiału:	max. thickness of workpiece:	макс. толщина обрабатываемого материала:	
drewna	wood	древесины	60 mm
metalu	steel	стали	6 mm
waga	weight	вес	1.8 kg
EAN	EAN	EAN	5902062035928

Ref. 58G096

18V

Li-Ion



Silnik bezszczotkowy
Brushless motor
Вентильный
электродвигатель



Funkcja podrzynania
Pendulum function
Функция подрезки

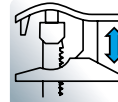

Regulacja wysunięcia stopy
Base position adjustment
Регулирование положения подошвы

części zamienne
spare parts / запчасти

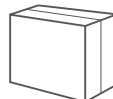

Dane techniczne	Specifications	Технические условия	
napięcie akumulatora	battery voltage	напряжение на аккумуляторе	18V DC
ilość obrotów	rpm	частота оборотов	0-3100 min ⁻¹
skok brzeszczotu	stroke length	ход полотна	28 mm
maksymalna grubość ciętego materiału:	max. thickness of workpiece:	макс. толщина обрабатываемого материала:	
drewna	wood	древесины	120 mm
metalu	steel	стали	10 mm
waga	weight	вес	3.4 kg
EAN	EAN	EAN	5902062065421

GRAPHITE
ENERGY+
system

3
YEARS
WARRANTY

3 lata gwarancji na WSZYSTKIE elektronarzędzia, urządzenia, akumulatory i ładowarki marki GRAPHITE. Regulamin dostępny na graphite.pl
3-year warranty on all power tools, devices, batteries and chargers. Terms and conditions are available on en.graphite.pl
Гарантия распространяется на весь электроинструмент GRAPHITE, включая батареи. Подробная информация доступна на сайте ru.graphite.pl

Pilarka tarczowa akumulatorowa ENERGY+

Cordless circular saw / Kreissäge / Аккумуляторная дисковая пила / Пилка дискова / Akkus körfűrés / Circular / Kotoučová pila / Okružná pila / Krožna žaga / Diskinis pjūklas / Ripzāģis / Ketasaag / Циркуляр дисков / Kružna pila / Kružna testera / Διακοπιοβο / Sierra circular / Sega circolare / Plainade disco / Scie circulaire / Schijfzaag

Ref. 58G008

18V
Li-Ion



Wskaznik laserowy
Laser indicator
Лазерный указатель



WYDAJNOŚĆ / EFFICIENCY / ПРОИЗВОДИТЕЛЬНОСТЬ

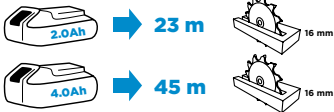

części zamienne
spare parts / запчасты

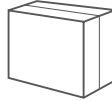

Dane techniczne	Specifications	Технические условия	
napięcie akumulatora	battery voltage	напряжение на аккумуляторе	18V DC
prędkość obrotowa	rotational speed	частота вращения	4200 min ⁻¹
zakres cięcia ukośnego	bevel cutting range	диапазон наклонного распила	0° ÷ 45°
max. średnica tarczy	maximum wheel diameter	макс. диаметр диска	150 mm
wewnętrzna średnica tarczy	inner wheel diameter	диаметр отверстия диска	10 mm
max. głębokość cięcia pod kątem 90°	max. cutting depth at 90° angle	макс. глубина распила под углом 90°	48 mm
max. głębokość cięcia pod kątem 45°	max. cutting depth at 45° angle	макс. глубина распила под углом 45°	36 mm
waga	weight	вес	2.5 kg
EAN	EAN	EAN	5902062035363

Opalarka akumulatorowa ENERGY+

Cordless Heat Gun / Schnurlose Heißluftpistole / Аккумуляторная тепловая пушка / Аккумуляторна теплова гармата / Akkus hőlégfúvó / Arma de căldură fără fir / Akumulátorová tepelná pistole / Brezžični toplotni pištol / Akumulatorinis šilumos pistoletas / Bezvoda karstuma pistole / Juhtmeta soojuspüstol / Безжичен топлинен пушотел / Bežični toplinski pištolj / Бежични топлотни пушотел / Πιστόλι θερμότητας χωρίς καλώδιο / Pistola de calor sin cuerda / Pistola termica a batteria / Pistola de calor sem fio / Pistolet à chaleur sans fil

Ref. 58G082

18V
Li-Ion

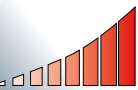

Szybki start
Quick start
Быстрый старт



Oświetlenie
Lighting
Освещение



Dane techniczne	Specifications	Технические условия	
napięcie akumulatora	battery voltage	напряжение батареи	18V DC
moc	power	сила	270 W
przepływ powietrza	air flow	воздушный поток	200 l/min
temperatura	temperature	температура	550°C
waga	weight	вес	0.6 kg
EAN	EAN	EAN	5902062503497

Ref. 58G023

18V
Li-Ion



Silnik bezszczotkowy
Brushless motor
Вентильный электродвигатель



części zamienne
spare parts / запчасты

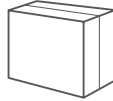

Dane techniczne	Specifications	Технические условия	
napięcie akumulatora	battery voltage	напряжение на аккумуляторе	18V DC
prędkość obrotowa	rotational speed	частота вращения	4200 min ⁻¹
zakres cięcia ukośnego	bevel cutting range	диапазон наклонного распила	0° ÷ 45°
max. średnica tarczy	maximum wheel diameter	макс. диаметр диска	165 mm
wewnętrzna średnica tarczy	inner wheel diameter	диаметр отверстия диска	20 mm
max. głębokość cięcia pod kątem 90°	max. cutting depth at 90° angle	макс. глубина распила под углом 90°	52 mm
max. głębokość cięcia pod kątem 45°	max. cutting depth at 45° angle	макс. глубина распила под углом 45°	35 mm
waga	weight	вес	2.95 kg
EAN	EAN	EAN	5907558480061

Szyna prowadząca

Guide rail / Führungsschiene / Ведущий рельс / Шина напрямна / Vezetősín / Sină de ghidaj / Vodící lišta / Vodiaca koľajnička / Vodilna praga / Kreipimo bėgelis / Vadsliede / Juhtsijn / Водещя шина / Traka vodilica / Vodeći žljeb / Pálya-öbnyós / Guia / Binario di guida / Barra guidora / Rail de guidage / Geleiderail

Ref. 58G023-732



for 58G008, 58G023

Dane techniczne	Specifications	Технические условия	
długość	length	длина	2x 700 mm
EAN	EAN	EAN	5902062065322



10*
YEARS
SPARE PARTS
AVAILABILITY

* Części zamienne dostępne na: gtxservice.pl

* Spare parts available on: gtxservice.pl

* Запасные части на: gtxservice.pl

@GRAPHITE

GRAPHITEmov

graphite.pl

Pistolet klejowy ENERGY+

Glue gun / Leimpistole / Пистолет клеевой / Пистолет клеювий / Ragasztópisztoly / Pistol de lipit / Lepici pistole / Pištol lepiaca / Lepilna pištola / Klijy pistoletas / Limes pistole / Liimpistol / Пистолет за силикон / Pištoli za plastiku / Pistoli za plastiku / Πιστόλι θερμοκόλλησης / Pistola surtidora de pegamento / Pistola incollante / Pistola p. cola / Pistolet à colle / Lijmpistol

Ref. 58G040

18V
Li-Ion

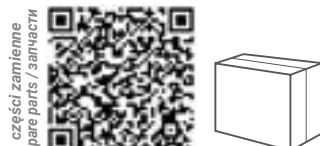
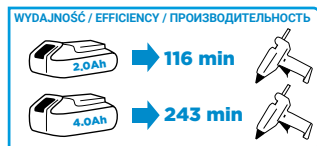
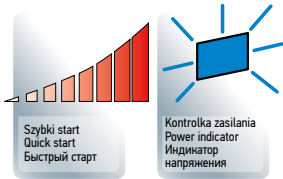

Dane techniczne	Specifications	Технические условия	
napięcie akumulatora	battery voltage	напряжение на аккумуляторе	18V DC
średnica wkładu klejowego	diameter of the glue insert	диаметр клеевого вкладыша	11 mm
temperatura elementu grzejnego	heating element temperature	температура нагревательного элемента	160°C±210°C
czas rozgrzewania	warming up time	время разогрева	3 min
wydajność	capacity	производительность	8 g/min
waga	weight	вес	0.4 kg
EAN	EAN	EAN	5907558480078

Pompka akumulatorowa ENERGY+

Cordless inflator / Schnurloser Inflator / Аккумуляторный насос / Аккумуляторний надувач / Akkumulátoros feltöltő / Inflator färrä fir / Akumulátorový nafukovač / Akumulátorový nafukovač / Napajalnik brez akumulatorja / Akumulátorinis pripūtiklis / Bezvada piepūle / Juhtmeta täitur / Аккумуляторен надувател / Akumulatorski naduvanač / Аккумуляторски надувач / Ασύρματη φουσκωτή / Inflador inalámbrico / Gonfiatore a batteria / Inflator sem fio / Gonfleur sans fil

58G089

18V
Li-Ion

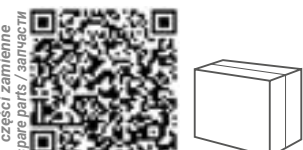

Dane techniczne	Specifications	Технические условия	
napięcie akumulatora	battery voltage	напряжение на аккумуляторе	18V DC
maksymalny przepływ powietrza	maximal air flow	максимальный воздушный поток	57 m³/h
waga	weight	вес	0.45 kg
EAN	EAN	EAN	5902062506832

Kompresor akumulatorowy z osprzętem ENERGY+

Inflator with accessories / Akku-Kompressor mit Zubehör / Компрессор аккумуляторный с оснасткой / Компрессор аккумуляторный с принадлежностями / Légkömlesztő tartozékokkal / Compresor de cumulator cu accesorii / Akumulátorový kompresor s príslušenstvom / Akumulátorový kompresor s príslušenstvom / Akumulátorový kompresor su iranga / Akumulatora kompresors ar piederumiem / Akukompressor koos tarvikutega / Аккумуляторен компресор с оборудване / Akumulatorski kompresor s opremom / Bateriaji akumulator s priborom / Συμπιεστής ελασφοριζόμενος με βοηθητικά εξαρτήματα / Compresor a bateria con accesorios / Compresore a batteria con accessori / Compresor de ar para bateria com acessórios / Compresseur à batterie avec accessoires / Batterijcompressor met accessoires

Ref. 58G041

18V
Li-Ion

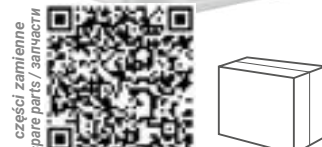
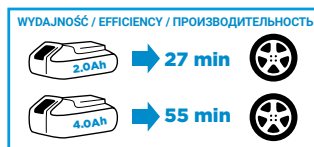

Dane techniczne	Specifications	Технические условия	
napięcie akumulatora	battery voltage	напряжение на аккумуляторе	18V DC
prędkość obrotowa	rotational speed	частота вращения	21000 min ⁻¹
max ciśnienie	max. pressure	макс. давление	100 psi (7 bar)
waga	weight	вес	0.8 kg
EAN	EAN	EAN	5907558480085

Zszywacz akumulatorowy 2w1 ENERGY+

Cordless nailer and staple gun / 2-in-1-Batteriehefter / Аккумуляторный степлер 2в1 / Аккумуляторний степлер 2в1 / Akkuszűzőgép 2 az 1-ben / Capsator de baterie 2in1 / Sešivačka baterii 2v1 / Žošivačka batérii 2v1 / Spenjač z baterijo 2v1 / Dviejų viename akumuliatorių segiklis / 2-in-1 akumulatoria skavotājs / 2-űhész aku klammerdaja / 2в1 мелкод за батарея / 2-в-1 батеријски спенјач / Специјални акумулатор 2у1 / Συρραπτικό μπαταρίας 2 σε 1 / Grapadora de batería 2en1 / Pinzatrice per batteria 2in1 / Grampeador de bateria 2em1 / Agrafeuse à batterie 2en1

Ref. 58G081

18V
Li-Ion

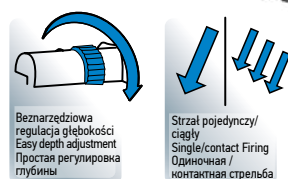

Dane techniczne	Specifications	Технические условия	
napięcie akumulatora	battery voltage	напряжение на аккумуляторе	18V DC
Maksymalna ilość operacji na minutę	Maximum number of operations per minute	Максимальное число операций в минуту	100
Średnia ilość operacji na minutę	Average number of operations per minute	Среднее количество операций в минуту	60
Maksymalna długość zszywki	Maximum nail length	Максимальная длина гвоздя	50 mm
Maksymalna szerokość zszywki	Maximum staple length	Максимальная длина скобы	40 mm
Maksymalna pojemność magazynka (zszywki/gwoździe)	Maximum magazine capacity (staples / nails)	Максимальная емкость магазина (скобы/гвозди)	100
waga	weight	вес	2.7 kg
EAN	EAN	EAN	5902062503480

Zszywki

Staples / Klammern / Скобы / Скобу / Tűzőkapocs / Capsator / Sešivací spony / Sponky / Sponke / Kabes / Skavas / Klambrid / Телчета / Municija za klamericu / Heftalica / Συρραπίδες / Grapas / Puntti metallici / Pontas / Agrafes / Hechters

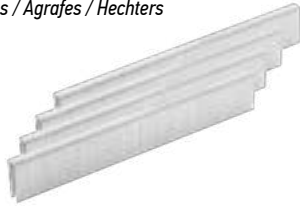
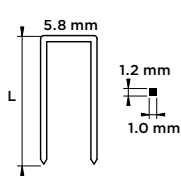

GA18 TYPE 90

for 58G081

Ref.	L [mm]			EAN
56H750	19	400	0/100	5902062506849
56H751	22	400	0/100	5902062506856
56H752	25	400	0/100	5902062506863
56H753	28	400	0/50	5902062506870
56H754	32	400	0/50	5902062506887
56H755	38	400	0/50	5902062506894
56H756	40	400	0/50	5902062506900

Gwoździe

Nails / Nägel / Гвозди / Цяґли / Tűzőszeg / Cuie / Hřebíky / Klinec / Žebjji / Viny / Naglas / Naelad / Пирони за тачер / Čavlići za pneumatsku klamericu / Municija za heftalica / Καρφιά / Clavos / Chiodi E / Pontas / Agrafes / Spijkers

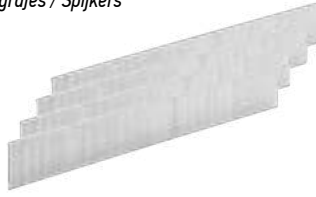
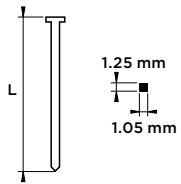

GA18 TYPE 90

for 58G081

Ref.	L [mm]			EAN
56H760	20	400	0/100	5902062506917
56H761	25	400	0/100	5902062506924
56H762	30	400	0/100	5902062506931
56H763	32	400	0/100	5902062506948
56H764	38	400	0/100	5902062506955
56H765	40	400	0/100	5902062506962
56H766	45	400	0/100	5902062506979
56H767	50	400	0/100	5902062506986

Odkurzacz akumulatorowy ENERGY+

Cordless vacuum cleaner / Akku-Staubsauger / Пылесос аккумуляторный / Пилосос аккумуляторный / Akkumulátoros porszívó / Aspirator de praful acumulator / Akumulátorový vysavač / Vysavač akumulátorový / Akumulatorski sesalnik / Akumulatorinis siurblys / Akumulatora putekšūcējs / Juhtmeta tolmuimeja / Аккумуляторна Прахосмукачка / Akumulatorski usisavač / Bežični usisivač / Ασύρματη Ηλεκτρική Ακούνα / Aspiradora a batería / Aspirapolvere a batteria / Aspirador sem fio / Aspirateur à batterie / Draadloze stofzuiger

Ref. 58G097

18V
Li-Ion



Filter pyłowy hepa
Hera dust filter
Пылевой фильтр hepa



Dane techniczne	Specifications	Технические условия	
napięcie akumulatora	battery voltage	напряжение на аккумуляторе	18V DC
objętość pojemnika na kurz	dust container	контейнер для пыли	0.5l
waga	weight	вес	0.9
EAN	EAN	EAN	5902062065391

Wentylator akumulatorowo-sieciowy ENERGY+

Battery and mains powered fan / Batterie- und netzbetriebener Ventilator / Вентилятор с питанием от аккумулятора и от сети / Вентилятор від аккумулятора та живлення від мережі / Akkumulátoros és hálózati ventilátor / Ventilator cu baterie și rețea / Batterie a síťový ventilátor / Ventilátor napájaný z batérie a zo siete / Ventilator z baterijo in napajanjem iz omrežja / Baterija ir maitinimo šaltinis / Ventilators ar akumulatoru un elektrotīklu / Aku ja voolutoitega ventilator / Вентилатор за батерию и храненияца устройства / Ventilator na bateriju i parajanje / Вентилатор са батеријом и напајањем / Ανεμιστήρας με μπαταρία και ρεύμα / Baterija y ventilador de red / Ventilatore a batteria e alimentato da rete / Bateria e ventilador alimentado pela rede / Ventilateur alimenté par batterie et secteur

Ref. 58G080

18V
Li-Ion

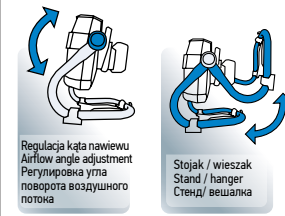

Regulacja kąta nawiewu
Airflow angle adjustment
Регулировка угла
поверота воздушного
потока

Stojak / wieszak
Stand / hanger
Стенд / вешалка

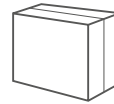
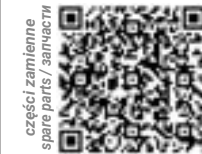

Dane techniczne	Specifications	Технические условия	
napięcie akumulatora	battery voltage	напряжение на аккумуляторе	18V DC
maksymalne natężenie przepływu wentylatora	maximum fan flow rate	максимальный вентилятор потока скорость	25,88 m³/min
maksymalna prędkość powietrza	maximum air speed	максимальная скорость воздуха	2,53 m/s
maksymalna prędkość obrotowa- bieg 1/bieg 2	maximum speed - gear 1/gear 2	максимальная скорость - передача 1 / передача 2	1700/2600 min ⁻¹
moc wentylatora	fan power	мощность вентилятора	14,7 W
waga	weight	вес	2,3
EAN	EAN	EAN	5902062503749

Adapter USB - latarka LED ENERGY+

USB adapter - LED flashlight / USB-adapter - LED-taschenlampe / Переходник USB - фонарик LED / Adapter USB - lixmap LED / USB adapter - LED lámpa / Adaptor USB - lanternă LED / USB adaptér - LED svítidla / USB adaptér - LED baterka / Adapter USB - svetilka LED / Jungtis USB - žibintuvėlis LED / USB adapters - LED lukuris / USB-adapter - LED-taskulap / USB adapter - LED фенер / Adapter USB - LED svjetiljka / USB adapter - LED lampa / Φορτιστ φωνιστρη με USB και φακο LED / Adaptador USB - linterna LED / Adattatore USB - torcia elettrica LED / Adaptateur USB - torche LED / USB adapter - LED zaklamp

Ref. 58G025

18V
Li-Ion



USB
POWER BANK



WYDAJNOŚĆ / EFFICIENCY / ПРОИЗВОДИТЕЛЬНОСТЬ	
2.0Ah	7200 mAh 25 h
4.0Ah	14400 mAh 50 h



Dane techniczne	Specifications	Технические условия	
napięcie akumulatora	battery voltage	напряжение на аккумуляторе	18V DC
moc	power	мощность	1 W
ilość diod	number of diodes	количество светодиодов	1
wyjścia zewnętrzne USB	external USB	внешние выходы USB	5V DC 1.5A
waga	weight	вес	0.11 kg
EAN	EAN	EAN	5907558480092

10*
YEARS
SPARE PARTS
AVAILABILITY

* Części zamienne dostępne na: gtxservice.pl

* Spare parts available on: gtxservice.pl

* Запасные части на: gtxservice.pl

@GRAPHITE

GRAPHITEmov

graphite.pl

Latarka akumulatorowa ENERGY+

Cordless flashlight / Taschenlampe / Аккумуляторный фонарь / Лихтарик / Akkus lámpa / Lanterna / Bateria / Lampa / Svetilka / Žibintuvēlis / Lukturis / Pōleti / Фенерче / Bateriajska lampa / Lampa / Φακός / Linterna de mano / Torcia / Lanterna / Torche / Zaklamp

Ref. 58G007

18V
Li-Ion

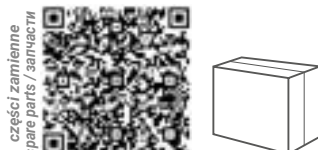
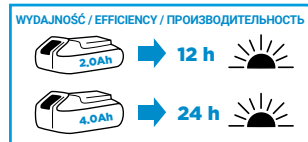

Dane techniczne	Specifications	Технические условия	
napięcie akumulatora	battery voltage	напряжение на аккумуляторе	18V DC
moc	power	мощность	3 W
ilość diod	number of diodes	количество светодиодов	3
strumień świetlny	luminous flux	световой поток	260 lm
temperatura barwowa	colour temperature	цветовая температура	7000 K
kąt świecenia	light angle	угол свечения	120°
waga	weight	вес	0.3 kg
EAN	EAN	EAN	5902062035356



Nagrzewnica gazowa ENERGY+

Gas heater / Gas-Lufterhitzer / Газовая тепловая пушка / Термогармата газова / Gázos hőlégfúvó / Aparat de incalzire gazos / Plynové topidlo / Plynový ohrievač / Plinski grelec / Dujinis šildytuvas / Gāzes šildītājs / Gaasisoojendi / Газов отоплительный уред / Plinski grijač zraka / Gasni grejač / Αερόθερμο αρειού / Calefactor a gas / Generatore di aria calda a gas / Aquecedor de gás / Générateur d'air chaud à gaz / Gasverwarmer

Ref. 58GE100

18V
Li-Ion

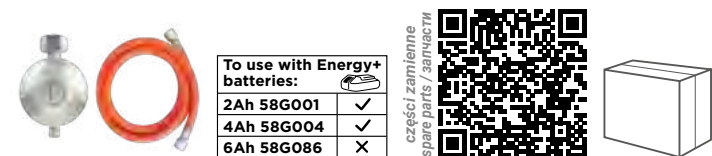

Dane techniczne	Specifications	Технические условия	
napięcie akumulatora	battery voltage	напряжение на аккумуляторе	18V DC
moc	power	мощность	15 kW
ciśnienie	pressure	давление	0.7 bar
zużycie paliwa	fuel consumption	потребление топлива	1.09 kg/h
przepływ powietrza	air flow	воздушный поток	320 m³/h
waga	weight	вес	3.5 kg
EAN	EAN	EAN	5902062069740

Ref. 58GE101

18V
Li-Ion

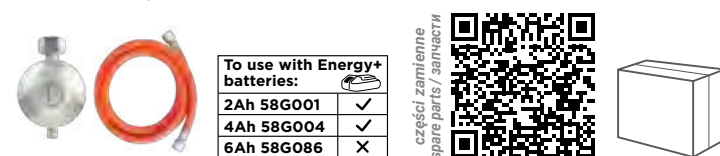

Dane techniczne	Specifications	Технические условия	
napięcie akumulatora	battery voltage	напряжение на аккумуляторе	18V DC
moc	power	мощность	30 kW
ciśnienie	pressure	давление	0.7 bar
zużycie paliwa	fuel consumption	потребление топлива	2.18 kg/h
przepływ powietrza	air flow	воздушный поток	500 m³/h
waga	weight	вес	4.8 kg
EAN	EAN	EAN	5902062069757

Podkaszarka akumulatorowa ENERGY+

Cordless grass trimmer / Akku-rasentrimmer / Аккумуляторный триммер / Триммер аккумуляторный / Akumulátoros szegélynyíró / Cositoare cu acumulator / Akumulátorový vyžinač / Akumulátoros kosilnica / Akumulátoros žaliapjöv / Akumulátoros trimmeris / Akutoitel trimmer / Аккумуляторен тример / Akumulatorski trimer za travu / Akumulatorska kosilnica / Επαφωρτιζόμενα χορτοκοπτικό / Desbrozadora a bateria / Tosaerba a filo a batteria / Accu heggenchaar

Ref. 58G030

18V
Li-Ion



Dodatkowa rękojeść 3D
Additional 3D handle
Дополнительная рукоятка 3D



Regulowana głowica
Adjustable head
Регулируемая головка



WYDAJNOŚĆ / EFFICIENCY / ПРОИЗВОДИТЕЛЬНОСТЬ



→ 32 min



→ 60 min



części zamienne
spare parts / запчасти

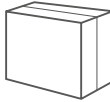

Dane techniczne	Specifications	Технические условия	
napięcie akumulatora	battery voltage	напряжение на аккумуляторе	18V DC
prędkość obrotowa	rotational speed	частота вращения	9000 min ⁻¹
szerokość koszenia	cutting width	ширина скашивания	254 mm
regulacja dł. rękojeści	handle length adjustment	регулировка глубины рукоятки	1.1-1.4 m
noże polimerowe	polymer blades	полимерные ножи	88.5 mm
waga	weight	вес	1.8 kg
EAN	EAN	EAN	5902062057655

Noże do podkaszarki ENERGY+

Blades for grass cutter / Klängen für Grasschneider / Ножи для траворезки / Леза для різання трави / Kések fűkaszához / / Nože pro sekačku na trávu / Nože pre kosačku na trávu / Rezila za kosilnica za travu / Žalés pšovimo peiljai / Žalés plávėja asmenį / Rohulõikuri terad / Ножове за косачка за трева / Oštrice za sječač trave / Seciwa za sekač trave / Λεπίδες για κόφτη χορτού / Cuchillas para cortadora de césped / Lame per tagliaerba / Láminas para cortador de relva / Lames pour tondeuse à gazon / Bladen voor grasmaaier

Ref. K/58G030-30



Dane techniczne	Specifications	Технические условия	
ilość	quantity	количество	20
EAN	EAN	EAN	5902062810090



Kosa akumulatorowa ENERGY+

Cordless Grass Cutter / Schnurloser Grasschneider / Аккумуляторный триммер для травы / Аккумуляторна коса / Akkus fűnyíró / Tăietor de iarbă fără fir / Akumulátorová sekačka na trávu / Akumulátorová kosačka na trávu / Akumulatorski rezalnik trave / Bevielis žalés pšoviklis / Bezvada žalés plávējs / Juhtmeta murulõikur / Аккумуляторен резач за трева / Bežični rezač trave / Akumulatorski rezač trave / Κόφτης χωρίς χορτό / Cortador de césped inalámbrico / Tagliaerba a batteria / Cortador de grama sem fio / Coupe-herbe sans fil

Ref. 58G035

36V
Li-Ion

18V 18V
ENERGY+
36V SYSTEM



Silnik bezszczotkowy
Brushless motor
Вентиляторный электродвигатель



2w1 (żyłka / nóż)
2 in 1 (line / knife)
2 в 1 (леска / нож)

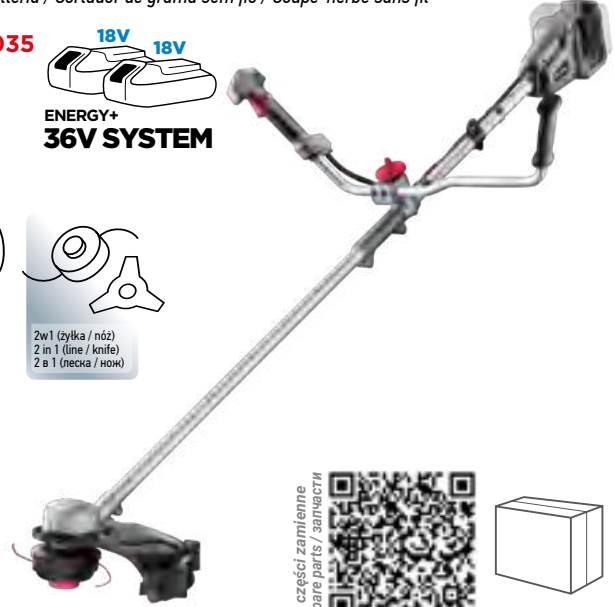

części zamienne
spare parts / запчасти

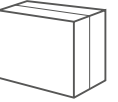

Dane techniczne	Specifications	Технические условия	
napięcie akumulatora	battery voltage	напряжение на аккумуляторе	36V DC
prędkość znamionowa bez obciążenia	rated speed without load	номинальная скорость без нагрузки	7000 min ⁻¹
średnica żyłki tnącej	cutting line diameter	диаметр линии резки	2 mm
pojemność szpuli	spool capacity	емкость катушки	6 m
szerokość cięcia żytką	circular cutting width	круговая ширина реза	350 mm
szerokość cięcia nożem	knife cutting width	ширина реза ножа	250 mm
waga	weight	вес	4.2 kg
EAN	EAN	EAN	5902062510051

Kosiarka akumulatorowa ENERGY+

Cordless mower / Batteriemäher / Аккумуляторная косилка / Аккумуляторна косарка / Akkulátor fűnyíró / Cositoare de baterii / Akumulátorová sekačka / Akumulátorová kosačka / Baterijska kosilnica / Akumulatorinis vejapjöv / Akumulatoru plaujmašina / Aku niiduk / Батерия косачка / Akumulatorski kosilnica / Akumulatorska kosačka / Ασύρματο χλοοκοπτικό / Cortadora de batería / Rasaerba batteria / Cortador de batería / Tondeuse à batterie / Accu maaiër

Ref. 58G033

36V
Li-Ion

18V 18V
ENERGY+
36V SYSTEM

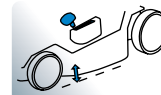

6 poziomów koszenia
6 cutting height steps
6 ступеней высоты стрижки



Łatwe składanie
Easy folding
Легкое складывание



części zamienne
spare parts / запчасти

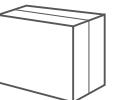

Dane techniczne	Specifications	Технические условия	
napięcie akumulatora	battery voltage	напряжение на аккумуляторе	36V DC
prędkość obrotowa wrzeczona bez obciążenia	spindle speed without load	скорость шпинделя без нагрузки	2800 min ⁻¹
stopień ochrony	level of security	уровень безопасности	IPX4
szerokość koszenia	cutting width	ширина реза	400 mm
ilość regulacji wysokości koszenia	number of mowing height adjustments	количество регулировок высоты кошения	6
zakres wysokości koszenia	cutting height range	диапазон высоты стрижки	25-75 mm
pojemność kosza na trawę	grass catcher capacity	емкость травосборника	40 l
waga	weight	вес	16.5 kg
EAN	EAN	EAN	5902062500076

10*
YEARS
SPARE PARTS
AVAILABILITY

* Części zamienne dostępne na: gtxservice.pl

* Spare parts available on: gtxservice.pl

* Запасные части на: gtxservice.pl

@GRAPHITE

GRAPHITEmov

graphite.pl

Sektor akumulatorowy ENERGY+

Cordless pruning scissors / Gartenschere Akku / Секатор аккумуляторный / Секатор аккумуляторный / Akkumulátoros metszőolló / Faarfce de gradina cu acumulator / Akumulátorové zahradnické nůžky / Záhradné nožnice akumulátorové / Akumulatorski sekalnik / Akumulatorinis sekatorius / Akumulatora dārza grieznes / Akutoitel lõikur / Градински ножици акумулаторни / Akumulatorske škare / Akumulatorske makaze / Ψαλίδι κλαδέματος επαναφορτιζόμενο / Podador a batería / Cesioje elettriche / Corta-sebes de batería / Sécateur à batterie / Takkenschaar

Ref. 58G029

18V
Li-Ion



Silnik bezszczotkowy
Brushless motor
Вентильный
электродвигатель



Przycisk bezpieczeństwa
Safety switch
Защитный
выключатель

części zamienne
spare parts / запчасты

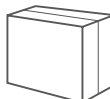

Dane techniczne	Specifications	Технические условия	
napięcie akumulatora	battery voltage	напряжение на аккумуляторе	18V DC
maksymalna średnica cięcia	max cutting diameter	максимальный диаметр резки	30 mm
waga	weight	вес	1.0 kg
EAN	EAN	EAN	5902062510013

Urządzenie ogrodowe na wysięgniku 2w1 ENERGY+

Garden device with extension arm / Gartengerät mit Auslegerarm / Садовое устройство с удлинителем / Kerti eszköz hosszabbító karral / Dispozitiv de gradina cu brat de extensie / Zahradni zarizeni s prodluzovacim ramenem / Záhradné zariadenie s predlžovacím ramenom / Vrtna naprava s podaljškom / Sodo irenginy su prailgintuvu / Dārza ierīce ar pagarinātāju / Pikendusarrega aia seade / Градинско устройство с удължаващо рамо / Vrtni uređaj s produžnim krakom / Baštenski uređaj sa produžnom rukom / Συσκευή κήπου με βραχίονα προέκτασης / Dispositivo de jardín con brazo extensible / Dispositivo da giardino com braccio di estensione / Dispositivo de jardinagem com braço de extensão / Dispositif de jardinage avec bras d'extension / Tuinapparaat met verlengarm

Ref. 58G098

18V
Li-Ion



Silnik bezszczotkowy
Brushless motor
Вентильный
электродвигатель

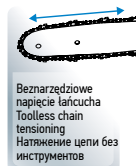

Bezprzędzowe napięcie łańcucha
Toolless chain tensioning
Натяжение цепи без инструментов

części zamienne
spare parts / запчасты

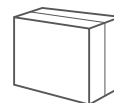

Dane techniczne	Specifications	Технические условия	
napięcie akumulatora	battery voltage	напряжение на аккумуляторе	18V DC
dlugość	length	длина	1.14 / 1.87 m
		pilarka/chainsaw/бензопила	
predkość liniowa łańcucha (bez obciążenia)	chain linear speed (no load)	линейная скорость цепи (без нагрузки)	8 m/s
przewodnica	type of guide	тип руководства	8" (200 mm)
podziałka łańcucha	chain pitch	шаг цепи	3/8" (9,53 mm)
grubość łańcucha	chain thickness	толщина цепи	0,05" (1,27 mm)
pojemność zbiornika oleju łańcuchowego	chain oil tank capacity	ёмкость масляного бака цепи	0.1 l
		nożyce/hedge trimmer/ножницы для живой изгороди	
obroty na biegu jałowym	no load blade speed	скорость ножа без нагрузки	1300 min ⁻¹
szerokość cięcia	cutting width	ширина резки	430 mm
maksymalna grubość ciętej tędzy	max. cutting thickness	максимальная толщина резки	15 mm
waga	weight	вес	8.4 kg
EAN	EAN	EAN	5902062065407

Nożyce do żywopłotu akumulatorowe ENERGY+

Cordless hedge trimmer / Akku-heckenschere / Ножницы для живой изгороди аккумуляторные / Кущоріз аккумуляторний / Akkumulátoros sövényvágó / Faarfce de tuns gardul viu cu acumulator / Akumulátorové nůžky na živý plot / Akumulátorové nožnice na živý plot / Baterijske škarje za živo mejo / Akumulatorinis gyvatvorių žirklys / Akumulatora dzīvzoga šķēres / Akutoitel hekilõikur / Аккумуляторни ножици за жив плев / Akumulatorske škare za živicu / Akumulatorske makaze za živicu / Ψαλίδι μπορντούρα επαναφορτιζόμενο / Cortasetos a batería / Tagliasiepi a batteria / Accu kettingzaag

Ref. 58G032

18V
Li-Ion



części zamienne
spare parts / запчасты

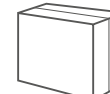

Dane techniczne	Specifications	Технические условия	
napięcie akumulatora	battery voltage	напряжение на аккумуляторе	18V DC
predkość ostrza bez obciążenia	no load blade speed	скорость ножа без нагрузки	1300 min ⁻¹
szerokość cięcia	cutting width	ширина резки	510 mm
dt. listwy tnącej	blade bar length	длина режущей части	570 mm
max. grubość cięcia	max. cutting thickness	макс. толщина срезаемых веток	15 mm
waga	weight	вес	2.2 kg
EAN	EAN	EAN	5902062057662

Ref. 58G042

36V
Li-Ion

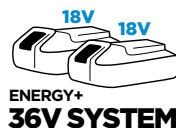

ENERGY+
36V SYSTEM



Obrotowa rekojeść
Rotating handle
Поворотная
рукоятка



WYDAJNOŚĆ / EFFICIENCY / ПРОИЗВОДИТЕЛЬНОСТЬ	
2x 2.0Ah	28 min
2x 4.0Ah	60 min

części zamienne
spare parts / запчасты

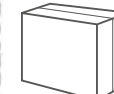

Dane techniczne	Specifications	Технические условия	
napięcie akumulatora	battery voltage	напряжение на аккумуляторе	36V DC
predkość ostrza bez obciążenia	no load blade speed	скорость ножа без нагрузки	2800 min ⁻¹
szerokość cięcia	cutting width	ширина резки	520 mm
dt. listwy tnącej	blade bar length	длина режущей части	595 mm
max. grubość cięcia	max. cutting thickness	макс. толщина срезаемых веток	20 mm
waga	weight	вес	3.0 kg
EAN	EAN	EAN	5902062501165

Pilarka łańcuchowa akumulatorowa ENERGY+

Cordless chain saw / Akku-kettensäge / Цепная аккумуляторная пила / Пилка ланцюгова акумуляторна / Akkumulátoros láncfűrész / Drujbã cu acumulator / Akumulátorová řetězová píla / Akumulátorová řetězová píla / Akumulatorska verižna žaga / Akumulatorinis grandininis pjūklas / Kēdes akumulatora motorzāģis / Akutoitel kettsaag / Верижен акумулаторен трион / Akumulatorska lančana pila / Akumulatorska motorna testera / Επαναφορτιζόμενο αλυσοπριονο / Sierra de cadena a batería / Motosega a batteria / Slanghaspel gemonteerd

Ref. 58G034

18V
Li-Ion



części zamienne
spare parts / запчастей

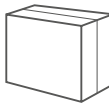

Dane techniczne	Specifications	Технические условия
napięcie akumulatora	battery voltage	напряжение на аккумуляторе
predkość bez obciążenia	no load speed	скорость без нагрузки
predkość liniowa łańcucha bez obciążenia	linear speed of the chain no load	линейная скорость цепи без нагрузки
pojemność zbiornika oleju	oil tank capacity	емкость масляного бака
system podawania oleju łańcuchowego	chain oil supply system	цепная система подачи масла
kółko łańcuchowe (zęby x podziałka)	chain wheel (teeth x pitch)	цепное колесо (зубья x шаг)
przewodnica	guide bar	направляющая планка
długość robocza przewodnicy podziałka łańcucha	working length of the guide chain pitch	рабочая длина направляющей шаг цепи
grubość łańcucha	chain thickness	толщина цепи
waga	weight	вес
EAN	EAN	EAN

Pilarka łańcuchowa akumulatorowa ENERGY+

Cordless chain saw / Akku-kettensäge / Цепная аккумуляторная пила / Пилка ланцюгова акумуляторна / Akkumulátoros láncfűrész / Drujbã cu acumulator / Akumulátorová řetězová píla / Akumulátorová řetězová píla / Akumulatorska verižna žaga / Akumulatorinis grandininis pjūklas / Kēdes akumulatora motorzāģis / Akutoitel kettsaag / Верижен акумулаторен трион / Akumulatorska lančana pila / Akumulatorska motorna testera / Επαναφορτιζόμενο αλυσοπριονο / Sierra de cadena a batería / Motosega a batteria / Slanghaspel gemonteerd

Ref. 58G043

36V
Li-Ion

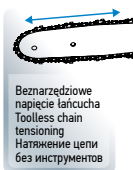
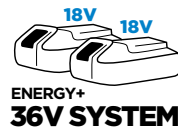

części zamienne
spare parts / запчастей

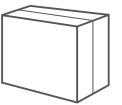

Dane techniczne	Specifications	Технические условия
napięcie akumulatora	battery voltage	напряжение на аккумуляторе
predkość bez obciążenia	no load speed	скорость без нагрузки
predkość liniowa łańcucha bez obciążenia	linear speed of the chain no load	линейная скорость цепи без нагрузки
pojemność zbiornika oleju	oil tank capacity	емкость масляного бака
system podawania oleju łańcuchowego	chain oil supply system	цепная система подачи масла
kółko łańcuchowe (zęby x podziałka)	chain wheel (teeth x pitch)	колесо цепи (зубья x шаг)
przewodnica	guide bar	направляющая планка
podziałka łańcucha	chain pitch	шаг цепи
grubość łańcucha	chain thickness	толщина цепи
waga	weight	вес
EAN	EAN	EAN

Prowadnica do pilarki łańcuchowej

Chain saw bar / Kettensägeführung / Направляющий стержень для цепной пилы / Стержень направляющий до пилки ланцюгової / Lánvezető láncfűrészhez / Ghidaj p/ț ferăstrău cu lanț / Vodici lišta řetězové píly / Vodiaca lišta řetazovej píly / Vodič verige za verižno žago / Kreipiančioji grandininiam pjūklui / Vadikla kēdes zāģim / Kettsae saetera / Шина за верижен трион / Vodičica za lančanu pilu / Vodičica za lančanu testeru / Καθοδηγητικό για αλυσοπριονο / Bomba de sumersión para agua sucia / Guida per catena / Guías de motosegura

Ref. K114807

Ref. K111769



Ref.	Info	Box	EAN
K114807	no.14,15,16	0/1	5902062068590
K111769	14" (350mm) No 40	0/1	5902062505415

Łańcuch do pilarki łańcuchowej

Chain for chain saw / Kettensägekette / Цепь для цепной пилы / Ланцюг до пилки ланцюгової / Fűrészlánc / Lanț p/ț ferăstrău cu lanț / Řetěz řetězové píly / Řetaz do řetazovej píly / Veriga za verižno žago / Grandinė grandininiam pjūklui / Kēde ķēžu zāģim / Kettsae kett / Верижа за верижен трион / Lanac za lančanu pilu / Lanac za lančanu testeru / Αλυσίδα για αλυσοπριονο / Cadena para sierra de cadena / Catena per sega a catena / Corrente para serra de motor / Chaîne pour scie à chaîne / Ketting voor kettingzaag

Ref. K114805

Ref. K111767



Ref.	Info	Box	EAN
K114805	no.2	0/1	5902062068576
K111767	No 38	0/1	5902062505392

10*
YEARS
SPARE PARTS
AVAILABILITY

* Części zamienne dostępne na: gtxservice.pl
* Spare parts available on: gtxservice.pl
* Запасные части на: gtxservice.pl

@GRAPHITE

GRAPHITEmov

graphite.pl

Dmuchała akumulatorowa ENERGY+

Cordless blower / Akku-gebläse / Аккумуляторная воздуходувка / Повітродувка акумуляторна (пилосос садовий) / Akkumulátoros lombfúvó / Sufiante/aspiratorului cu acumulator / Akumulátorový fukar / Akumulátorové dýchadlo / Baterijski pihalnik / Akumulátorinis lapų pūstuvas / Akumulatora lapu pūtejs / Akutoitel lehepuhur / Аккумуляторная духалка / Akumulatorski puhač lišča / Za upotrebu bežičnog ventilatora / Εναρφορτιζόμενος φουσητήρας / Soplador a batería / Soffiatore a batteria / Soprador de Folhas à Bateria / Souffleur à batterie / Accu grastrimmer

Ref. 58G031

18V
Li-Ion



Ergonomiczna rekojęć
Ergonomic handle
Эргономичная рукоятка

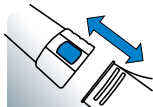

Łatwy transport
Easy transportation
Удобная транспортировка

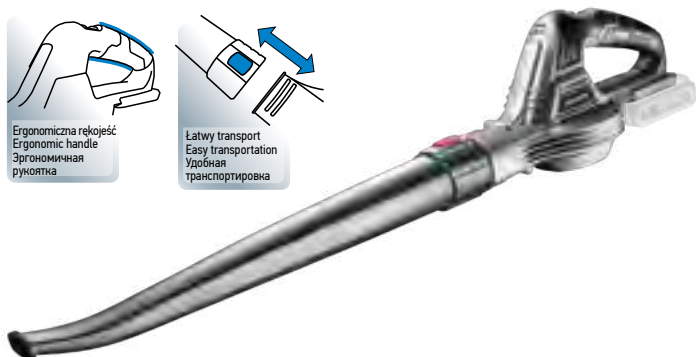

WYDAJNOŚĆ / EFFICIENCY / ПРОИЗВОДИТЕЛЬНОСТЬ



części zamienne
spare parts / запчасті

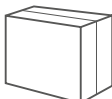

Dane techniczne	Specifications	Технические условия
napięcie akumulatora	battery voltage	напряжение на аккумуляторе
obroty	speed	частота вращения
prędkość przepływu powietrza	air flow speed	скорость воздушного потока
waga	weight	вес
EAN	EAN	EAN

Odkurzacz ogrodowy ENERGY+

Garden vacuum cleaner / Gartenstaubsauger / Пылесос садовый / Пилосос садівничий / Lombszívó / Aspirator de gradina / Zahradní vysavač / Záhradný vysávač / Sesalnik za vrt / Lapų siurblys / Dārza puteklšūcējs / Leheimur / Градинска прахосмукачка / Vrtni usisavač / Vrtlarski usisivač / Ηλεκτρικός αναρροφητήρας / Aspiratore da giardino / Aspirador de jardim / Aspirateur de jardin / Tuinstofzuiger

Ref. 58G036

36V
Li-Ion

ENERGY+
36V SYSTEM

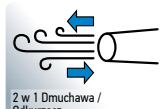

2 w 1 Dmuchała /
Odkurzacz
2in1 Blower / Vacuum
2 в 1 воздуходувка
/ вакуум



Rozdrabnianie: 9:1
Crushing rate: 9:1
Степень измельчения: 9:1



części zamienne
spare parts / запчасті

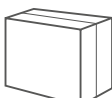

Dane techniczne	Specifications	Технические условия
napięcie akumulatora	battery voltage	напряжение на аккумуляторе
wydatek powietrza	air flow	поток воздуха
prędkość maksymalna powietrza	maximum air speed	максимальная скорость воздуха
stopień rozdrabniania	degree of grinding	степень помола
pojemność worka	bag capacity	емкость мешка
ilość prędkości	the amount of speed	количество скорости
waga	weight	вес
EAN	EAN	EAN

Ref. 58G044

36V
Li-Ion

ENERGY+
36V SYSTEM



Ergonomiczna rekojęć
Ergonomic handle
Эргономичная рукоятка



Łatwy transport
Easy transportation
Удобная транспортировка



części zamienne
spare parts / запчасті

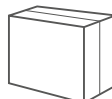

Dane techniczne	Specifications	Технические условия
napięcie akumulatora	battery voltage	напряжение на аккумуляторе
obroty	speed	частота вращения
prędkość przepływu powietrza	air flow speed	скорость воздушного потока
waga	weight	вес
EAN	EAN	EAN

Myjka akumulatorowa ENERGY+

Cordless cleaner / Schnurloser Reiniger / Аккумуляторный очиститель / Аккумуляторный очищающий / Vezeték nélküli tisztítószert / Detergent fűrés / Akumulátorový čistič / Akumulátorový čistič / Brezžični čistilec / Belaidis valiklis / Bezvada tīrītājs / Juhtmeta puhastusvahend / Безжичен почистващ препарат / Bežično čiščenje / Akumulatorski čistač / Ασύρματο καθαριστικό / Limpador inalámbrico / Detergente senza fili / Limpador sem fio / Nettoyeur sans fil / Draadloze reiniger

Ref. 58G083

18V
Li-Ion

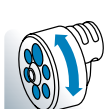

Dysza wielofunkcyjna
Multi-function Nozzle
Многофункциональная насадка

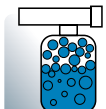

Pianownica
Foaming bottle
Пенная бутылка



części zamienne
spare parts / запчасті

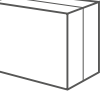

Dane techniczne	Specifications	Технические условия
napięcie akumulatora	battery voltage	напряжение на аккумуляторе
ciśnienie i bieg	pressure i gear	давление i передача
ciśnienie ii bieg	pressure ii gear	передача давления ii
maksymalny przepływ wody i bieg	maximum water flow i gear	максимальный расход воды i передача
maksymalny przepływ wody ii bieg	maximum water flow, 2nd gear	максимальный расход воды, 2-я передача
wysokość podnoszenia wody	water lifting height	высота подъема воды
waga	weight	вес
EAN	EAN	EAN

GRAPHITE
ENERGY+
system

3
YEARS
WARRANTY

3 lata gwarancji na WSZYSTKIE elektronarzędzia, urządzenia, akumulatory i ładowarki marki GRAPHITE. Regulamin dostępny na graphite.pl
3-year warranty on all power tools, devices, batteries and chargers. Terms and conditions are available on en.graphite.pl

Гарантия распространяется на весь электроинструмент GRAPHITE, включая батареи. Подробная информация доступна на сайте ru.graphite.pl

Akumulator systemu ENERGY+

Battery / Akkumulator / Аккумуляторная батарея / Акумулятор / Akkumulátor / Acumulator / Akumulátor / Akumulátor / Akumulátor / Akumulátorius / Akumulators / Aku / Акумулятор / Akumulator / Akumulator / Ηλεκτρικός συσσωρευτής / Bateria / Batterie / Batterie / Batterie / Accu

18V
Li-Ion









Ref.	[Ah]		EAN
58G001	2.0	0/10	5902062035295
58G004	4.0	0/10	5902062035325
58G086	6.0	0/20	5902062501158

Ładowarka do akumulatorów ENERGY+







GRAPHITE ENERGY+ battery charger / Akku-Ladegerät / Зарядное устройство системы GRAPHITE ENERGY+ / Зарядний пристрій для акумуляторів / Töltő / Incarator pentru acumulatori / Nabíječka baterií / Nabíjačka akumulátora / Polnilnik za akumulatorje / Akumulatorių įkroviklis / Akumulatoru lādētājs / Akulaadija / Зарядно устройство за акумулаторуме / Punjač za akumulatore / Punjač za akumulator / Φορτιστής / Cargadora para baterías / Carica batterie / Carregador de baterias / Chargeur à batteries / Accuoplader

2.3A

	→	60 min	
	→	120 min	
	→	180 min	



x2 3A

	→	45 min	
	→	90 min	
	→	135 min	



Ref.	[A]		EAN
58G002	2.3	0/8	5902062035301
58G085	2x 3	0/10	5902062501141



10*
YEARS
SPARE PARTS
AVAILABILITY

* Części zamienne dostępne na: gtxservice.pl
* Spare parts available on: gtxservice.pl
* Запасные части на: gtxservice.pl

 @GRAPHITE

 GRAPHITEmov

graphite.pl

Wiertarko-wkrętarka akumulatorowa Energy+, akumulator 2Ah, ładowarka

Power tool set / Elektogeräteset / Набор электроинструментов / Набір електроінструменту / Akkus gépkészlet / Set de scule electrice / Sada elektrického nářadí / Súprava elektrického nářadia / Komplet električnih orodij / Elektrinių įrankių komplektas / Elektroinstrumentu komplekts / Elektritööriistade komplekt / Комплект электроинструменту / Set električnih uređaja / Komplet elektrouredaja / Σετ ηλεκτρικών εργαλείων / Juego de herramientas eléctricas / Trapano avvitatore a batteria / Kit de eletroferamentas / Jeu d'outils électriques / Set van elektrogereedschap

Ref. 58G000-SET1

18V
Li-Ion

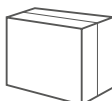

Ref.	Info		EAN
58G000-SET1	18V DC, 0.8-10 mm, 0-350 min ⁻¹ , 0-1250 min ⁻¹	0/5	5902062503633

Wiertarko-wkrętarka akumulatorowa Energy+, 2 akumulatory 2Ah, ładowarka, walizka

Power tool set / Elektogeräteset / Набор электроинструментов / Набір електроінструменту / Akkus gépkészlet / Set de scule electrice / Sada elektrického nářadí / Súprava elektrického nářadia / Komplet električnih orodij / Elektrinių įrankių komplektas / Elektroinstrumentu komplekts / Elektritööriistade komplekt / Комплект электроинструменту / Set električnih uređaja / Komplet elektrouredaja / Σετ ηλεκτρικών εργαλείων / Juego de herramientas eléctricas / Trapano avvitatore a batteria / Kit de eletroferamentas / Jeu d'outils électriques / Set van elektrogereedschap

Ref. 58G006-SET2

18V
Li-Ion



Ref.	Info		EAN
58G006-SET2	18V DC, 2-13 mm, 0-350 min ⁻¹ , 0-1250 min ⁻¹	0/4	5902062503640

Wiertarko-wkrętarka akumulatorowa Energy+, 2 akumulatory 2Ah, ładowarka, walizka

Power tool set / Elektogeräteset / Набор электроинструментов / Набір електроінструменту / Akkus gépkészlet / Set de scule electrice / Sada elektrického nářadí / Súprava elektrického nářadia / Komplet električnih orodij / Elektrinių įrankių komplektas / Elektroinstrumentu komplekts / Elektritööriistade komplekt / Комплект электроинструменту / Set električnih uređaja / Komplet elektrouredaja / Σετ ηλεκτρικών εργαλείων / Juego de herramientas eléctricas / Trapano avvitatore a batteria / Kit de eletroferamentas / Jeu d'outils électriques / Set van elektrogereedschap

Ref. 58G022-SET2

18V
Li-Ion

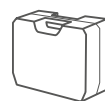

Ref.	Info		EAN
58G022-SET2	18V DC, 0.8-10 mm, 0-350 min ⁻¹ , 0-1250 min ⁻¹	0/4	5902062503718

Wiertarko-wkrętarka akumulatorowa bezszczotkowa Energy+, akumulator 2Ah, ładowarka, walizka

Power tool set / Elektogeräteset / Набор электроинструментов / Набір електроінструменту / Akkus gépkészlet / Set de scule electrice / Sada elektrického nářadí / Súprava elektrického nářadia / Komplet električnih orodij / Elektrinių įrankių komplektas / Elektroinstrumentu komplekts / Elektritööriistade komplekt / Комплект электроинструменту / Set električnih uređaja / Komplet elektrouredaja / Σετ ηλεκτρικών εργαλείων / Juego de herramientas eléctricas / Trapano avvitatore a batteria / Kit de eletroferamentas / Jeu d'outils électriques / Set van elektrogereedschap

Ref. 58G019-SET1

18V
Li-Ion



Ref.	Info		EAN
58G019-SET1	18V DC, 2-13 mm, 0-500 min ⁻¹ , 0-1700 min ⁻¹	0/4	5902062503664

Wiertarko-wkrętarka aku bezszczotkowa z udarem Energy+, 2 akumulatory 2Ah, ładowarka, walizka

Power tool set / Elektogeräteset / Набор электроинструментов / Набір електроінструменту / Akkus gépkészlet / Set de scule electrice / Sada elektrického nářadí / Súprava elektrického nářadia / Komplet električnih orodij / Elektrinių įrankių komplektas / Elektroinstrumentu komplekts / Elektritööriistade komplekt / Комплект электроинструменту / Set električnih uređaja / Komplet elektrouređaja / Σει ηλεκτρικών εργαλείων / Juego de herramientas eléctricas / Trapano avvitatore a batteria / Kit de eletroferamentas / Jeu d'outils électriques / Set van elektrogereedschap

Ref. 558G020-SET2

18V
Li-Ion



Ref.	Info		EAN
58G020-SET2	18V DC, 2-13 mm, 0-500 min ⁻¹ , 0-1700 min ⁻¹ , 1 - 16 + drilling + impact drilling	0/4	5902062503688

Wiertarko-wkrętarka akumulatorowa Energy+, 2 akumulatory 2Ah, ładowarka, walizka aluminiowa, akcesoria

Power tool set / Elektogeräteset / Набор электроинструментов / Набір електроінструменту / Akkus gépkészlet / Set de scule electrice / Sada elektrického nářadí / Súprava elektrického nářadia / Komplet električnih orodij / Elektrinių įrankių komplektas / Elektroinstrumentu komplekts / Elektritööriistade komplekt / Комплект электроинструменту / Set električnih uređaja / Komplet elektrouređaja / Σει ηλεκτρικών εργαλείων / Juego de herramientas eléctricas / Trapano avvitatore a batteria / Kit de eletroferamentas / Jeu d'outils électriques / Set van elektrogereedschap

Ref. 58G022-PS15

18V
Li-Ion



Ref.	Info		EAN
58G22-PS15	18V DC, 0.8-10 mm, 0-350 min ⁻¹ , 0-1250 min ⁻¹	0/2	5902062058515

Wiertarko-wkrętarka akumulatorowa Energy+, latarka, torba, akumulator 2Ah

Power tool set / Elektogeräteset / Набор электроинструментов / Набір електроінструменту / Akkus gépkészlet / Set de scule electrice / Sada elektrického nářadí / Súprava elektrického nářadia / Komplet električnih orodij / Elektrinių įrankių komplektas / Elektroinstrumentu komplekts / Elektritööriistade komplekt / Комплект электроинструменту / Set električnih uređaja / Komplet elektrouređaja / Σει ηλεκτρικών εργαλείων / Juego de herramientas eléctricas / Trapano avvitatore a batteria / Kit de eletroferamentas / Jeu d'outils électriques / Set van elektrogereedschap

Ref. 58G016

18V
Li-Ion



Ref.	Info		EAN
58G016	18V DC, 0.8-10 mm, 0-350 min ⁻¹ , 0-1250 min ⁻¹	0/2	5902062038357

Torba na elektronarzędzia ENERGY+

Power tool bag / Werkzeugtasche / Сумка для электроинструмента / Торба інструментальна / Géptartó táská / Geanta scule / Brašna na nářadí / Taška na montérska / Torba za orodje / Krepšys įrankiams / Instrumentu soma / Tööriistakott / Чанта за инструменти / Torba za alat / Torba za alat / Σάκος για εργαλεία / Bolsa para herramientas / Borsa in tela / Saco p. ferramentas / Sac à outils / Gereedschapstas

Ref. 58G015

12L
Poliester



Ref. 58G021

24L
Poliester



Ref.	Info		EAN
58G015	12 l, 0.7 kg, 25x25x25 cm	0/12	5902062035431
58G021	24 l, 1.5 kg, 50x25x25 cm	0/6	5902062045966

10*
YEARS
SPARE PARTS
AVAILABILITY

* Części zamienne dostępne na: gtxservice.pl
* Spare parts available on: gtxservice.pl
* Запасные части на: gtxservice.pl

 @GRAPHITE

 GRAPHITEmov

graphite.pl

Walizka materiałowa na elektronarzędzia ENERGY+

Fabric tool case / Werkzeugkoffer aus Stoff / Ящик для инструментов из ткани / Тканина футляр для инструментів / Szövet szerszámok / Cutie pentru scule din țesătură / Látkovő pouzdro na náradí / Látkové puzdro na náradie / Ohišje orodja iz blaga / Audinio įrankių dėklas / Auduma instrumentu korpuss / Riidest tööriistakott / Кальф за инструменти от плат / Torba za alat od tkanine / Torba za alat od tkanine / Υφασμάτινη θήκη εργαλείου / Caja de herramientas de tela / Valigetta portautensili in tessuto / Maleta de tecido / Mallette à outils en tissu / Stoffen / Gereedschapskoffer

Ref. 58G094



25L
Poliester



Ref.	Info	📦 [kg]	📦	EAN
58G094	25 l, 46x36x15,5 cm	1,4	0/4	5902062510174

Skrzynia na elektronarzędzia ENERGY+

Tool box / Werkzeugkasten / Ящик для инструмента / Скриня інструментальна / Szerszámoszláda / Cutie scule / Nářadová skříňka / Basa na náradie / Škatla za orodje / Įrankių dėžė / Instrumentu koferis / Tööriistakast / Куфар за инструменти / Kutija za alat / Kutija za alat / Εργαλειοθήκη / Caja de herramientas / Casseta portautensili / Caixa p. ferramentas / Caisse à outils / Gereedschapskist

Ref. 58GE102

11L



Wkład piankowy dla ochrony elektronarzędzi
Foam insert for power tools protection
Вставка из пеноматериала для защиты электроинструмента
Skrzynie kompatybilne z systemem modułowym NEO 1
Chests compatible with the NEO 1 modular system
Комоды, совместимые с модульной системой NEO 1

Ref.	L-W-H [mm]	📦 [kg]	📦	EAN
58GE102	448 x 322 x 126 mm, 11 l	1,4	0/1	5902062071385

Walizka dla wiertarko-wkrętarek ENERGY+

Case for cordless drills E+ / Koffer für Akku-Bohrer E+ / Чехол для аккумуляторных дрелей E+ / Корпус для бездротових свердел E+ / Tok vezeték nélküli fűrókhoz E+ / Carcasă pentru burghie fără fir E+ / Pouzdro pro akumulátorové vrtačky E+ / Púzdro na akumulátorové vŕtačky E+ / Ohišje za brezžične vrtalnike E+ / Belaidžių grąžtų dėklas E+ / Korpuss bezvada urbijem E+ / Juhtmeta puuride korpus E+ / Кальф за акумулаторни тренировки E+ / Futrola za bežične bušilice E+ / Футрола за бежичне бушлице E+ / Θήκη για ασύρματα τρυπάνια E+ / Estuche para taladros inalámbricos E+ / Custodia per trapani a batteria E+ / Estujo para brocas sem fio E+ / Étui pour perceuses sans fil E+

Ref. 58G087



Ref.	Info	📦 [kg]	📦	EAN
58G087	for 58G000, 58G006, 58G010, 58G022	2,0	0/5	5902062503725

Torba na elektronarzędzia ENERGY+

Power tool bag / Werkzeugtasche / Сумка для электроинструмента / Торба інструментальна / Géptartó táska / Geanta scule / Brašna na náradí / Taška na montérsku / Torba za orodje / Krepšys įrankiams / Instrumentu soma / Tööriistakott / Чанма за инструменти / Torba za alat / Torba za alat / Σάκος για εργαλεία / Bolsa para herramientas / Borsla in tela / Sacco p. ferramentas / Sac à outils / Gereedschapstas

Ref. 58G092

18,5L
Poliester



Ref.	Info	📦 [kg]	📦	EAN
58G092	18.5 l, 46x24x45 cm	1,7	0/4	5902062506801

GRAPHITE
ENERGY+
system

3
YEARS
WARRANTY

3 lata gwarancji na WSZYSTKIE elektronarzędzia, urządzenia, akumulatory i ładowarki marki GRAPHITE. Regulamin dostępny na graphite.pl
3-year warranty on all power tools, devices, batteries and chargers. Terms and conditions are available on en.graphite.pl
Гарантия распространяется на весь электроинструмент GRAPHITE, включая батареи. Подробная информация доступна на сайте ru.graphite.pl

Torba na elektronarzędzia ENERGY+

Power tool bag / Werkzeugtasche / Сумка для электроинструмента / Торба інструментальна / Géptartó táská / Geanta scule / Brašna na nářadí / Taška na montérska / Torba za orodje / Krepšys įrankiams / Instrumentu soma / Tööriistakott / Чанта за инструменти / Torba za alat / Torba za alat / Σάκος για εργαλεία / Bolsa para herramientas / Borsa in tela / Saco p. ferramentas / Sac à outils / Gereedschapstas

Ref. 58G093

42L
Poliester



DURABLE MATERIAL

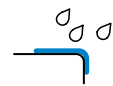

WATER PROOF



Ref.	Info	☐ [kg]	☐	EAN
58G093	42 L, 41x21x24 cm	5.0	0/2	5902062506818

Zestaw toreb ENERGY+

Set of bags E+ / Satz Taschen E+ / Набор сумок E+ / Набор сумок E+ / Táská halmaza E+ / Set de saci E+ / Sada tašek E+ / Sada tašek E+ / Set torbi E+ / Maišelių rinkinys E+ / Somu komplekts E+ / Kottide komplekt E+ / Комплект чанму E+ / Set torbi E+ / Cem торбу E+ / Σετ αποσκευών E+ / Conjunto de bolsas E+ / Set di borse E+ / Conjunto de malas E+ / Ensemble de sacs E+

Ref. 58G088

42L +18.5L
Poliester



DURABLE MATERIAL



WATER PROOF



Ref.	Info	☐ [kg]	☐	EAN
58G088	42 l	6.5	0/1	5902062503732



10*
YEARS
SPARE PARTS
AVAILABILITY

* Części zamienne dostępne na: gtxservice.pl
* Spare parts available on: gtxservice.pl
* Запасные части на: gtxservice.pl

@GRAPHITE

GRAPHITEmov

graphite.pl

Wkrętak akumulatorowy

Cordless screwdriver / Akkuschauber / Аккумуляторная отвертка / Шрубоверт аккумуляторный / Akkus csavarozó / Surubelnita cu acumulator / Akumulátorový šroubovák / Akumulátorový skrutkovač / Akumulatorski vijacnik / Akumulatorinis sukutvas / Akumulatora skrūvgriežis / Akukurivikeeraja / Акумуляторна отвертка / Akumulatorski izvijač / Akumulatorski odvijač / Εναρτηροζήμενο βραπανο-καταβίβο / Destornillador a batería / Avvitatore a batteria / Aparafusadora sem fio / Tournevis à batterie / Accu schroevendraaier

7.2V

Ref. 58G150



- 7.2V 230V-50Hz
60 min
- 230 min⁻¹
- 1.5Ah
Li-Ion
- 20+1 positions
- OŚWIETLENIE
LIGHTING
- left-right



Ref.	L-W-H [mm]	⊞ [kg]	📦	EAN
58G150	350-50-300	1.8	0/5	5902062581501

3.6V

Ref. 58G151



- Li-Ion
- 3.6V 230V-50Hz
3-5 h
- Индикатор
уровня заряда
аккумулятора
- 200 min⁻¹
- 1.3Ah
Li-Ion
- SCHOWEK
NA AKCESORIA
STORAGE BAY
FOR ACCESSORIES
- left-right
- BAZA
ŁADUJĄCA
CHARGING
STATION

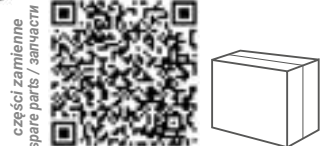

Ref.	L-W-H [mm]	⊞ [kg]	📦	EAN
58G151	345-70-245	1.0	0/10	5902062024237

Wiertarko-wkrętarka sieciowa

Electric screwdriver / Netzschrauber / Дрель-шуруповерт электрическая / Шрубоверт сетевой / Elektromos csavarhúzó / Surubelnita electrica / Elektrická vrtačka / Elektrický skrutkovač / Električni vijacnik / Elektrinis sukutvas / Tikla skrūvgriežis / Elektriline krivikeeraja / Мрежова бормашина / Električna bušilica / Električna bušilica / Ηλεκτρικό βραпано-καταβίβο / Atornillador eléctrico / Avvitatore elettrico / Máquina de pôr parafusos / Visseuse réseau / Elektrische boormachine

520W

Ref. 58G791



- WYPROFILOWANY
WŁACZNIK
ERGONOMIC
SWITCH
- ZACZEP
NA PAS
BELT
HANGER
- PASEK
NA DŁON
WRIST
STRAP
- 0-4500 min⁻¹
- 1/4" 6.35mm
- ERGONOMICZNY
UCHWYT
ERGONOMIC
HANDLE
- left-right



Ref.	L-W-H [mm]	⊞ [kg]	📦	EAN
58G791	370-100-300	2.9	0/5	5902062587916

250W

Ref. 58G792



- DWA BIEGI
MECHANICZNE
TWO MECHANICAL
GEARS
- I: 0-400 min⁻¹
II: 0-1450 min⁻¹
- 0.8 - 10 mm
- 23+1 positions
- left-right
- MAŁA
MASA
LIGHT
- 6 m



Ref.	L-W-H [mm]	⊞ [kg]	📦	EAN
58G792	375-90-290	2.9	0/5	5902062587923

GRAPHITE
POWER IN YOUR HANDS

3
YEARS
WARRANTY

3 lata gwarancji na WSZYSTKIE elektronarzędzia, urządzenia, akumulatory i ładowarki marki GRAPHITE. Regulamin dostępny na graphite.pl
3-year warranty on all power tools, devices, batteries and chargers. Terms and conditions are available on en.graphite.pl
Гарантия распространяется на весь электроинструмент GRAPHITE, включая батареи. Подробная информация доступна на сайте ru.graphite.pl

Wiertarka udarowa

Impact drill / Bohrerhammer / Дрель ударная / Дрель ударный / Útvefúró / Perforator de lovit / Příklepová vrtačka / Prikleповá vrtačka / Udarni vrtalnik / Gręztuvas su kalimu / Sitiena urbijašaina / Löökdrell / Бормашина ударна / Udarna bušilica / Udarna busilica / Κρουστικό δράπανο / Taladro de impacto / Trapano a percussione / Berbequim de impacto / Perceuse à choc / Slagboormachine

550W

Ref. 58G725



PLYNNA REGULACJA
OBROTÓW
VARIABLE
SPEED



0-3000 min⁻¹



OGRANICZNIK
GŁĘBOKOŚCI
WIERCENIA



0-48000 min⁻¹



BŁOKADA
WŁĄCZNIKA
SWITCH
LOCK



1.5 - 13 mm



max 13 mm



max 10 mm



max 25 mm

części zamienne
spare parts / запчасті



Ref.	L-W-H [mm]	☐ [kg]	☑	EAN
58G725	370-130-325	3.8	0/5	5902062024268

650W

Ref. 58G726



PLYNNA REGULACJA
OBROTÓW
VARIABLE
SPEED



0-3000 min⁻¹



OGRANICZNIK
GŁĘBOKOŚCI
WIERCENIA



0-48000 min⁻¹



BŁOKADA
WŁĄCZNIKA
SWITCH
LOCK



1.5 - 13 mm



max 13 mm



max 10 mm



max 28 mm

części zamienne
spare parts / запчасті



Ref.	L-W-H [mm]	☐ [kg]	☑	EAN
58G726	370-130-325	3.9	0/5	5902062024275

550W

Ref. 58G735



PLYNNA REGULACJA
OBROTÓW
VARIABLE
SPEED



0-3000 min⁻¹



OGRANICZNIK
GŁĘBOKOŚCI
WIERCENIA



0-48000 min⁻¹



BŁOKADA
WŁĄCZNIKA
SWITCH
LOCK



2 - 13 mm



max 13 mm



max 10 mm



max 25 mm

części zamienne
spare parts / запчасті

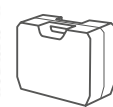

Ref.	L-W-H [mm]	☐ [kg]	☑	EAN
58G735	370-130-325	3.9	0/5	5902062024305

650W

Ref. 58G736



PLYNNA REGULACJA
OBROTÓW
VARIABLE
SPEED



0-3000 min⁻¹



OGRANICZNIK
GŁĘBOKOŚCI
WIERCENIA



0-48000 min⁻¹



BŁOKADA
WŁĄCZNIKA
SWITCH
LOCK



2 - 13 mm



max 13 mm



max 10 mm



max 28 mm

części zamienne
spare parts / запчасті

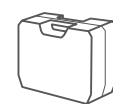

Ref.	L-W-H [mm]	☐ [kg]	☑	EAN
58G736	370-130-325	4.0	0/5	5902062024312

10*
YEARS
SPARE PARTS
AVAILABILITY

* Części zamienne dostępne na: gtxservice.pl
* Spare parts available on: gtxservice.pl
* Запасные части на: gtxservice.pl

@GRAPHITE

GRAPHITEmov

graphite.pl

Wiertarka udarowa

Impact drill / Bohrerhammer / Дрель ударная / Дрель ударный / Útvefúró / Perforator de lovit / Příklepová vrtačka / Prikleповá vrtačka / Udarni vrtnalnik / Gręztuvas su kalimu / Sitiena urbijašaina / Löökdrill / Бормашина ударна / Udarna bušilica / Udarna busilica / Кρούшкó брáново / Taladro de impacto / Trapano a percussione / Berbequim de impacto / Perceuse à choc / Slagboormachine

720W

Ref. 58G727



 PLYNNA REGULACJA OBROTÓW
VARIABLE SPEED

 OGRANICZNIK GŁĘBOKOŚCI WIERCENIA
0-3000 min⁻¹

 BLOKADA WŁĄCZNIKA SWITCH LOCK
0-48000 min⁻¹

 ALUMINIOWY KORPUS ALUMINUM BODY
1.5 - 13 mm

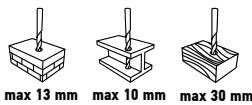
 max 13 mm max 10 mm max 30 mm

części zamienne
spare parts / запчасті



Ref.	L-W-H [mm]	kg	Box	EAN
58G727	425-130-335	4.5	0/4	5902062024282

850W

Ref. 58G728



 PLYNNA REGULACJA OBROTÓW
VARIABLE SPEED

 OGRANICZNIK GŁĘBOKOŚCI WIERCENIA
0-3000 min⁻¹

 BLOKADA WŁĄCZNIKA SWITCH LOCK
0-48000 min⁻¹

 max 13 mm max 13 mm max 32 mm

części zamienne
spare parts / запчасті

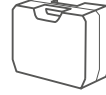

Ref.	L-W-H [mm]	kg	Box	EAN
58G728	425-130-335	4.7	0/5	5902062024299

850W

Ref. 58G738



 PLYNNA REGULACJA OBROTÓW
VARIABLE SPEED

 OGRANICZNIK GŁĘBOKOŚCI WIERCENIA
0-3000 min⁻¹

 BLOKADA WŁĄCZNIKA SWITCH LOCK
0-48000 min⁻¹

 ALUMINIOWY KORPUS ALUMINUM BODY
1.5 - 13 mm

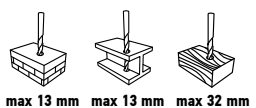
 max 13 mm max 13 mm max 32 mm

części zamienne
spare parts / запчасті



Ref.	L-W-H [mm]	kg	Box	EAN
58G738	430-130-335	4.9	0/4	5902062024329

1050W

Ref. 58G722



 DWA BIEGI MECHANICZNE
TWO MECHANICAL GEARS

 PLYNNA REGULACJA OBROTÓW
VARIABLE SPEED
I: 0-1100 min⁻¹
II: 0-3000 min⁻¹

 BLOKADA WŁĄCZNIKA SWITCH LOCK
I: 0-17600 min⁻¹
II: 0-48000 min⁻¹

 ALUMINIOWY KORPUS ALUMINUM BODY
1.5 - 13 mm

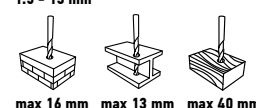
 max 16 mm max 13 mm max 40 mm

części zamienne
spare parts / запчасті

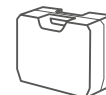

Ref.	L-W-H [mm]	kg	Box	EAN
58G722	430-130-335	5.4	0/4	5902062024251

GRAPHITE
POWER IN YOUR HANDS

3
YEARS
WARRANTY

3 lata gwarancji na WSZYSTKIE elektronarzędzia, urządzenia, akumulatory i ładowarki marki GRAPHITE. Regulamin dostępny na graphite.pl
3-year warranty on all power tools, devices, batteries and chargers. Terms and conditions are available on en.graphite.pl
Гарантия распространяется на весь электроинструмент GRAPHITE, включая батареи. Подробная информация доступна на сайте ru.graphite.pl

Wiertarka udarowa

Impact drill / Bohrerhammer / Дрель ударная / Дриль ударний / Útvefúró / Perforator de lovít / Priklepová vrtačka / Priklepová vrtačka / Udarni vrtalnik / Grežtuvas su kalimu / Sitiena urbjmašina / Löökdrell / Бормашина ударна / Udarna bušilica / Udarna busilica / Κρουστικό δράπανο / Taladro de impacto / Trapano a percussione / Berbequim de impacto / Perceuse à choc / Slagboormachine

1050W

Ref. 58G712

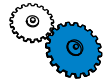

DWA BIEGI MECHANICZNE
TWO MECHANICAL GEARS



WYSOKI MOMENT OBROTOWY
HIGH TORQUE



ALUMINIOWY KORPUS
ALUMINUM BODY



ERGONOMICZNY KSZTAŁT
ERGONOMIC SHAPE



I: 0-900 min⁻¹
II: 0-2500 min⁻¹

I: 0-14000 min⁻¹
II: 0-40000 min⁻¹



3 - 16 mm



max 20 mm



max 16 mm



max 40 mm

części zamienne
spare parts / запчасті

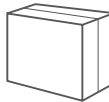

Ref.	L-W-H [mm]	☐ [kg]	☑	EAN
58G712	425-105-125	4.4	0/5	5902062000446

Młotowiertarka

Rotary hammer drill / Hammerbohrmaschine / Перфоратор / Перфоратор / Útvefúró / Bormasina percutanta / Vrtací kladivo / Vrtacie kladivo / Vrtalno kladivo / Perforatorius / Perforators / Lööktrell / Бормашина ударна / Čekić-bušilica / Bušilica sa čekićem / Σφύρα / Martillo-taladro / Martello perforatore / Martelo-Berbequim / Perceuse-marteau / Harmerboor

400W

Ref. 58G505

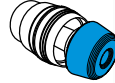

SDS-plus



PLYNNÁ REGULÁCIA OBROTŮV
VARIABLE SPEED

0-1500 min⁻¹



2 FUNKCJE
2 FUNCTIONS

0-6600 min⁻¹



1.5 J



MAŁA MASA
LIGHT

max 12 mm

max 10 mm

max 20 mm

części zamienne
spare parts / запчасті



Ref.	L-W-H [mm]	☐ [kg]	☑	EAN
58G505	330-90-240	2.8	0/5	5902062585059

Młotowiertarka

Rotary hammer drill / Hammerbohrmaschine / Перфоратор / Перфоратор / Útvefúró / Bormasina percutanta / Vrtací kladivo / Vrtacie kladivo / Vrtalno kladivo / Perforatorius / Perforators / Lööktrell / Бормашина ударна / Čekić-bušilica / Bušilica sa čekićem / Σφύρα / Martillo-taladro / Martello perforatore / Martelo-Berbequim / Perceuse-marteau / Harmerboor

720W

Ref. 58G527



0-1250 min⁻¹

0-5550 min⁻¹

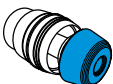

SDS-plus

2.8 J



4 FUNKCJE
4 FUNCTIONS

max 26 mm

max 13 mm

max 30 mm

części zamienne
spare parts / запчасті

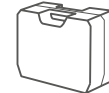

Ref.	L-W-H [mm]	☐ [kg]	☑	EAN
58G527	440-120-335	6.1	0/4	5902062022097

800W

Ref. 58G529



0-1200 min⁻¹

0-5300 min⁻¹



SDS-plus

3.2 J



4 FUNKCJE
4 FUNCTIONS

max 28 mm

max 13 mm

max 30 mm

części zamienne
spare parts / запчасті



Ref.	L-W-H [mm]	☐ [kg]	☑	EAN
58G529	440-116-335	6.2	0/4	5902062024244

10*
YEARS
SPARE PARTS
AVAILABILITY

* Części zamienne dostępne na: gtxservice.pl
* Spare parts available on: gtxservice.pl
* Запасные части на: gtxservice.pl

@GRAPHITE

GRAPHITEmov

graphite.pl

Młotowiertarka

Rotary hammer drill / Hammerbohrmaschine / Перфоратор / Перфоратор / Ütvefűró / Bormasina percutanta / Vrtací kladivo / Vrtacie kladivo / Vrtalno kladivo / Perforatorius / Perforators / Лёкөтрелл / Бормашина ударна / Чекић-буšилац / Буšилац са чекићем / Σφύρα / Martillo-taladro / Martello perforatore / Martelo-Berbequim / Perceuse-marteau / Harmerboor

900W

Ref. 58G528



Ref.	L-W-H [mm]	Ⓛ [kg]	🔋	EAN
58G528	440-120-335	5.7	0/4	5902062011077

Młot udarowy

Hammer drill / Schlaghammer / Перфоратор / Перфоратор / Fúrókalapács / Pickamer / Bourací kladivo / Prikleповé kladivo / Udarno kladivo / Atskelimo plaktukas / Trieciņveseris / Puurvasar / Кърмач / Ударни чекић / Ударни чекић / Σφύρα / Martillo de percusión / Demolitore / Martelo de impacto / Marteau à chocs / Slaghamer

900W

Ref. 58G858



Ref.	L-W-H [mm]	Ⓛ [kg]	🔋	EAN
58G858	460-180-290	9.2	0/2	5902062588586

Młot udarowy

Hammer drill / Schlaghammer / Перфоратор / Перфоратор / Fúrókalapács / Pickamer / Bourací kladivo / Prikleповé kladivo / Udarno kladivo / Atskelimo plaktukas / Trieciņveseris / Puurvasar / Кърмач / Ударни чекић / Ударни чекић / Σφύρα / Martillo de percusión / Demolitore / Martelo de impacto / Marteau à chocs / Slaghamer

1500W

Ref. 58G862

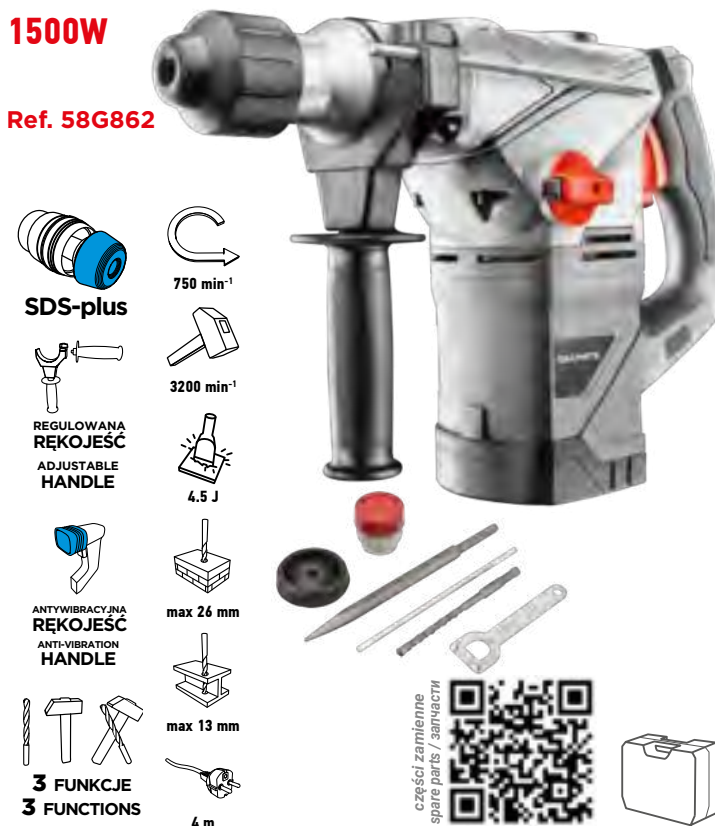

Ref.	L-W-H [mm]	Ⓛ [kg]	🔋	EAN
58G862	425-145-340	9.4	0/2	5902062588623

1250W

Ref. 58G874



Ref.	L-W-H [mm]	Ⓛ [kg]	🔋	EAN
58G874	510-140-360	12.5	0/2	5902062588746

GRAPHITE
POWER IN YOUR HANDS

3
YEARS
WARRANTY

3 lata gwarancji na WSZYSTKIE elektronarzędzia, urządzenia, akumulatory i ładowarki marki GRAPHITE. Regulamin dostępny na graphite.pl
 3-year warranty on all power tools, devices, batteries and chargers. Terms and conditions are available on en.graphite.pl
 Гарантия распространяется на весь электроинструмент GRAPHITE, включая батареи. Подробная информация доступна на сайте ru.graphite.pl

Młot wyburzeniowy

Demolition hammer / Abbruchhammer / Бетонолом / Молоток відбійний / Βontókalapács / Ciocan demolator / Bouraci kladivo / Búracie kladivo / Rušilno kladivo / Atskélimo plaktukas / Betona lauznis / Pliikvasar / Кърпач / Čekič za lomljenje / Čekič za rušenje / Σφύρα / Martillo picador / Martello demolitore / Martelo de demolição / Marteau de démolition / Slagmoer /

1050W

Ref. 58G875



Ref.	L-W-H [mm]	☐ [kg]	☑	EAN
58G875	483-365-145	10.0	0/2	5902062503572

1200W

Ref. 58G876



Ref.	L-W-H [mm]	☐ [kg]	☑	EAN
58G876	530-160-400	11.4	1/2	5902062588760

1700W

Ref. 58G878



Ref.	L-W-H [mm]	☐ [kg]	☑	EAN
58G878	790-180-385	17.4	0/1	5902062588784

1700W

Ref. 58G867



Ref.	L-W-H [mm]	☐ [kg]	☑	EAN
58G867	760-270-158	21	0/1	5902062588678

10*
YEARS
SPARE PARTS
AVAILABILITY

* Części zamienne dostępne na: gtxservice.pl
* Spare parts available on: gtxservice.pl
* Запасные части на: gtxservice.pl

@GRAPHITE

GRAPHITEmov

graphite.pl

Wiertarko-mieszarka

Drill mixer / Bohr-Mischer / Дрель-миксер / Дрель низкооборотной / Fűrő keverőgép / Perforator mic / Vrtačka-miřačka / Mieřač farby / Vrtalnik/meřalnik / Gręztuvas - maiřyklę / Urbjmařina mikseris / Drell (madala kiirusega) / Бормашина / Mikser u koferu / Busilca / Δράπανο χαμηλής ταχύτητας / Taladradora mezcladora / Trapano miscelatore / Berbequim-misturador / Perceuse-mélangeur / Boor-mixer

850W

Ref. 58G605



Ref.	L-W-H [mm]	☐ [kg]	📦	EAN
58G605	310-210-300	5.7	0/4	5902062586056

Mieszarka

Mixer / Rührmaschine / Миксер / Змішувач / Keverőgép / Mixer / Miřačka / Mieřačka / Meřalnik / Maisytuvus / Mikseris / Segumikser / Миксер / Električna mjeřalica / Mikser / Αναδευτήρας / Mezclador eléctrico / Miscelatore / Misturador eléctrica / Mélangeur électrique / Elektrische mixer

1250W

Ref. 58G783

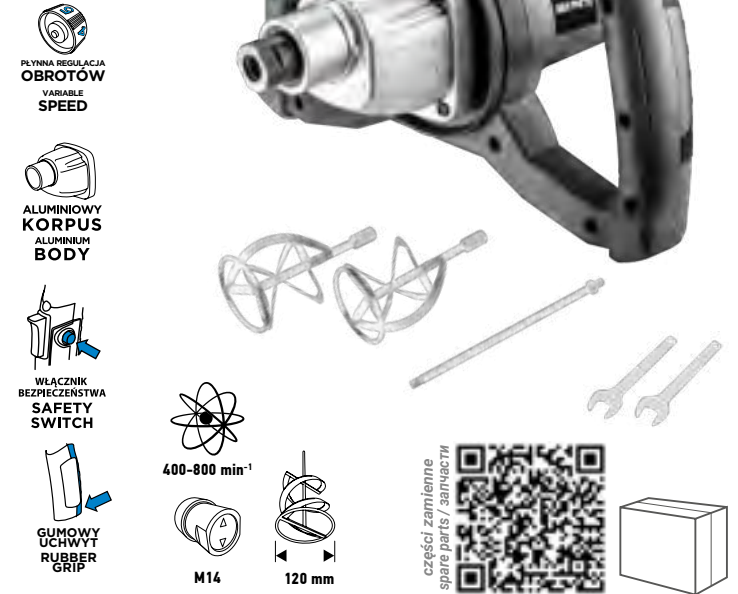

Ref.	L-W-H [mm]	☐ [kg]	📦	EAN
58G783	420-295-205	6.6	0/2	5902062058102

Mieszarka

Mixer / Rührmaschine / Миксер / Змішувач / Keverőgép / Mixer / Miřačka / Mieřačka / Meřalnik / Maisytuvus / Mikseris / Segumikser / Миксер / Električna mjeřalica / Mikser / Αναδευτήρας / Mezclador eléctrico / Miscelatore / Misturador eléctrica / Mélangeur électrique / Elektrische mixer

1400W

Ref. 58G785



Ref.	L-W-H [mm]	☐ [kg]	📦	EAN
58G785	420-295-210	7.5	0/2	5902062058119

1600W

Ref. 58G787



Ref.	L-W-H [mm]	☐ [kg]	📦	EAN
58G787	410-290-205	5.9	1/2	5902062058126

GRAPHITE
POWER IN YOUR HANDS

3
YEARS
WARRANTY

3 lata gwarancji na WSZYSTKIE elektronarzędzia, urządzenia, akumulatory i ładowarki marki GRAPHITE. Regulamin dostępny na graphite.pl
3-year warranty on all power tools, devices, batteries and chargers. Terms and conditions are available on en.graphite.pl
Гарантия распространяется на весь электроинструмент GRAPHITE, включая батареи. Подробная информация доступна на сайте ru.graphite.pl

Mieszarka dwuwrzecionowa

Double spindle mixer / Zweispindelmischer / Двошпиндельный смеситель / Міксер двошпиндельний / Duplaorsó-keverő / Amestecedor dublu ax / Dvojvřetenové míchadlo / Dvojvřetenová miešacka / Dvovřetení mešalnik / Dviejų sraigtų maišytuvai / Divvārpstu maišītājs / Kahe spindliga segisti / Двойна бъркалка / Міксер с два вретена / Dvorična mešalica / Αναδευτήρας υλικών οικοδομών / με δύο ατράκτους / Mezclador de dos husillos / Miscelatore doppio / Misturador de dois fusos / Mélangeur à double broche / Mixer met dubbele spindel

1800W

Ref. 58G789



Ref.	L-W-H [mm]	☐ [kg]	📦	EAN
58G789	528-340-235	8.3	1/2	5902062503565

Zestaw mieszadeł

Mixing paddles / Rührer / Мешалки / Насадки до змішування / Tartozék keverőgéphez / Agitatore / Míchadla / Miešadlá / Mešala / Maišyklės / Maisītāji / Visplid / Бъркачки / Мješalice / Mešalo / Αναδευτήρες / Varilla para mezclador / Set di pale per miscelatore / Misturadores / Agitateurs / Set van mixers

Ref. 58G788-96

Ref. 58G788-97



Ref.	Info	☐ [kg]	📦	EAN
58G788-96	do lekkich mas i farb, 590 x 120 mm	1.1	0/6	5902062469328
58G788-97	do zapraw, klejów i ciężkich mas, 590 x 120 mm	1.0	0/1	5902062469335

Mieszadło do zapraw

Mortar mixer / Mörtelrührer / Мешалка для растворов / Мшалка до чамуру будівельного / Festékkeverőszár / Mixer ciment / Míchačka malty / Miešač na maltu / Mešalnik za barvo / Maišykle skiediniui / Mikseris massām / Mórdisegisti / Бъркалка / Міксер за бою / Міксер за бою / Αναδευτήρας κονιάματος / Varilla para mezclador de mortero / Frusta per miscelatore / Misturador p. Argamassa / Agitateur à mortier / Mortelmixer

Ref. 58G784-96



Ref.	L-W-H [mm]	☐ [kg]	📦	EAN
58G784-96	590x120 mm, for 58G784, M14	1.2	0/10	5902062469304

Mieszadło

Mixer / Rührer / Мешалка / Міксер / Festékkeverőszár / Mixer / Míchačka / Mešalnik / Maišykle / Mikseris / Segisti / Mikser / Μίκτης / Cesta agitadora / Frusta per miscelatore / Misturador / Agitateur / Verfmixer

Ref. 58G784-97

Ref. 58G782-96



Ref.	L-W-H [mm]	☐ [kg]	📦	EAN
58G784-97	610 x 160 mm, M14	1.7	0/8	5902062469311
58G782-96	590 x 120 mm, M14	1.3	0/10	5902062469113

Ref. 56H710

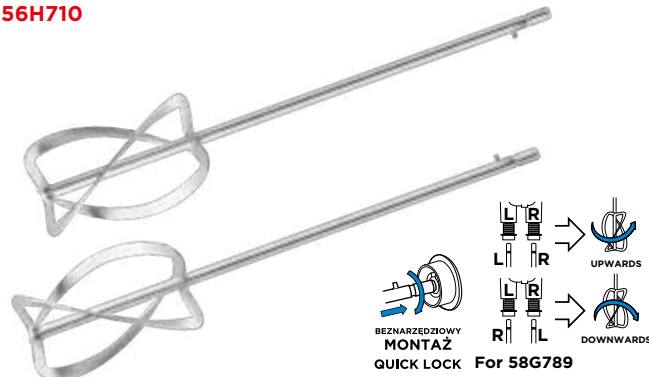

Ref.	L-W-H [mm]	☐ [kg]	📦	EAN
56H710	580 x 120 mm, for 58G789, samozaciskowe, 2 pcs.		0/10	5902062503756

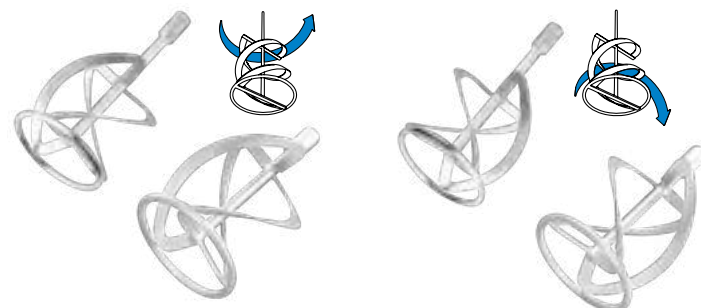

56H701

56H703

56H702

56H704

Ref.	Info	☐ [kg]	📦	EAN
56H701	120 mm, podciągające	0.7	0/40	5902062058133
56H702	120 mm, wtlaczające	0.7	0/40	5902062058140
56H703	140 mm, podciągające	0.8	0/30	5902062058157
56H704	140 mm, wtlaczające	0.8	0/30	5902062058164

Trzpień mieszadła

Shank / Stift / Штырь / Хвостовик / Csap / Dorn / Trn / Hrot / Gred / Ašis / Tapa / Varras / Шуфп / Klin / Vretno, stožer / Πείρος / Vástago / Codolo / Fuso / Mandrin / Schenkel

Ref. 56H700

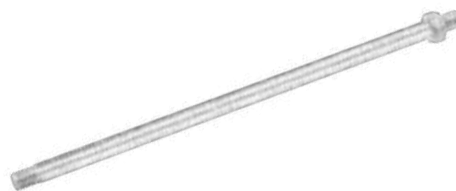

Ref.	Info	☐ [kg]	📦	EAN
56H700	M14, 380 mm, for 56H701, 56H702, 56H703, 56H704	0.5	0/50	5902062058171

10*
YEARS
SPARE PARTS
AVAILABILITY

* Części zamienne dostępne na: gtxservice.pl
* Spare parts available on: gtxservice.pl
* Запасные части на: gtxservice.pl

@GRAPHITE

GRAPHITEmov

graphite.pl

Szlifierka kąтова

Angle grinder / Winkelschleifer / Шлифмашина угловая / Шлифмашина наріжна / Sarokcsizoló / Maşină unghiulară de şlefuit / Bruska úhlová / Brúška uhlová / Kotni brusilnik / Kampinis šlifjuoklis / Leŋka slipmašina / Nurklivija / Ёглошайф / Brusilica kutna / Brusilica ugaona / Γωνιακός τροχός / Amoladora angular / Smerigliatrice angolare / Disco de limar p. cantos / Meuleuse d'angle / Versteckschuurmachine

750W

Ref. 59G063

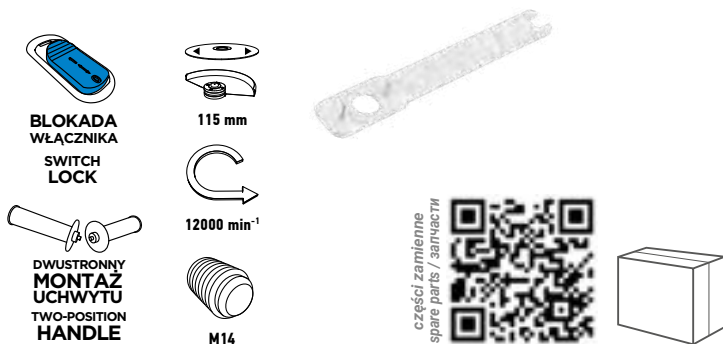

Ref.	L-W-H (mm)	Ⓛ [kg]	📦	EAN
59G063	320-100-120	2.5	0/6	5902062024336

900W

Ref. 59G087

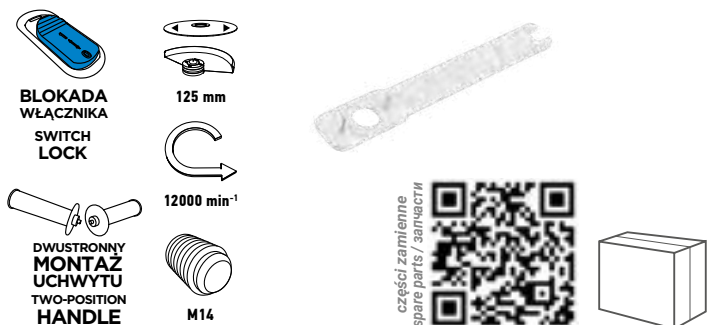

Ref.	L-W-H (mm)	Ⓛ [kg]	📦	EAN
59G087	330-130-120	2.5	0/6	5902062024343

720W

Ref. 59G072



Ref.	L-W-H (mm)	Ⓛ [kg]	📦	EAN
59G072	340-140-125	2.5	0/8	5902062000286

900W

Ref. 59G187



Ref.	L-W-H (mm)	Ⓛ [kg]	📦	EAN
59G187	325-125-110	2.7	0/6	5902062034649

GRAPHITE
POWER IN YOUR HANDS

3
YEARS
WARRANTY

3 lata gwarancji na WSZYSTKIE elektronarzędzia, urządzenia, akumulatory i ładowarki marki GRAPHITE. Regulamin dostępny na graphite.pl
3-year warranty on all power tools, devices, batteries and chargers. Terms and conditions are available on en.graphite.pl

Гарантія розповсюджується на весь електронструмент GRAPHITE, включаючи батареї. Подрібна інформація доступна на сайті ru.graphite.pl

Szlifierka kątowa

Angle grinder / Winkelschleifer / Шлифмашина угловая / Шлифмашинака наріжна / Sarokcsiszoló / Maşină unghiulară de şlefuit / Bruska úhlová / Brúška uhlová / Kotni brusilnik / Kampinis šliuoklis / Leŋka slipmašina / Nurklivija / Ёглошайф / Brusilica kutna / Brusilica ugaona / Γωνιακός τροχός / Amoladora angular / Smerigliatrice angolare / Disco de limar p. cantos / Meuleuse d'angle / Verstekschuurmachine

1100W

Ref. 59G110

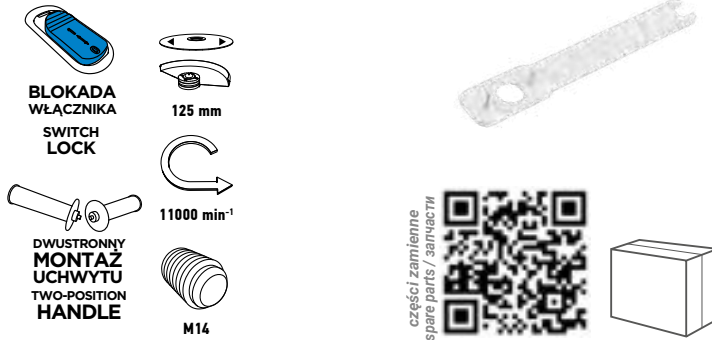

Ref.	L-W-H [mm]	Ⓢ [kg]	📦	EAN
59G110	325-125-110	2.9	0/6	5902062022356

1600W

Ref. 59G088

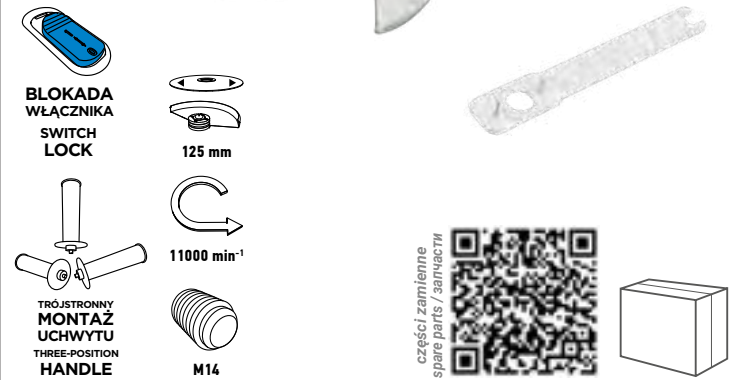

Ref.	L-W-H [mm]	Ⓢ [kg]	📦	EAN
59G088	360-145-130	3.2	0/6	5902062063878

1600W

Ref. 59G188

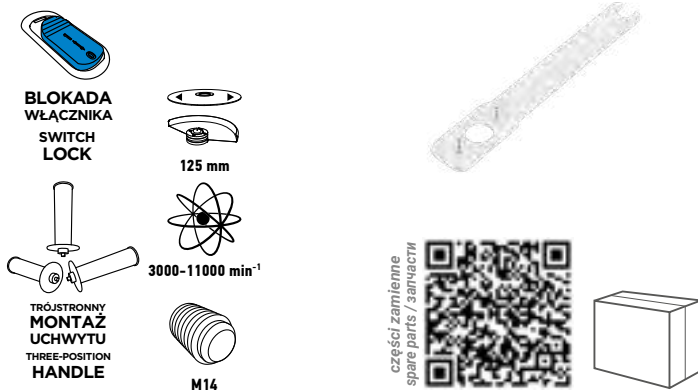

Ref.	L-W-H [mm]	Ⓢ [kg]	📦	EAN
59G188	360-145-135	3.2	0/6	5902062063885

1200W

Ref. 59G120

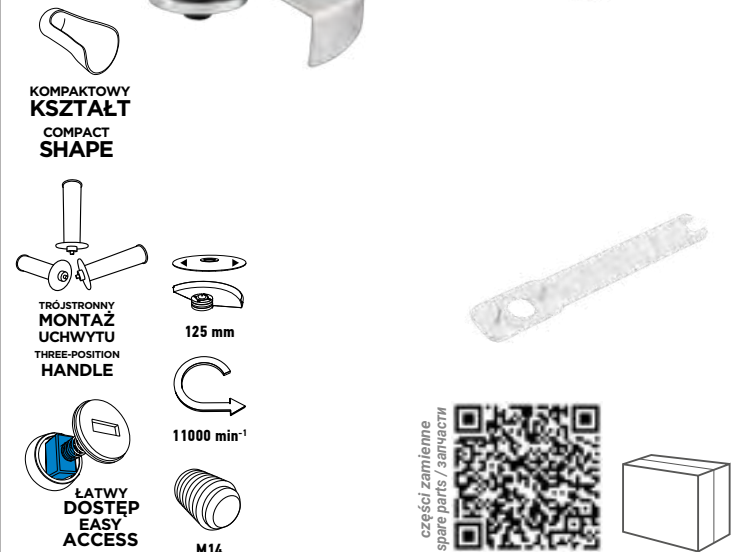

Ref.	L-W-H [mm]	Ⓢ [kg]	📦	EAN
59G120	450-130-100	3.8	0/4	5902062034632

10*
YEARS
SPARE PARTS
AVAILABILITY

* Części zamienne dostępne na: gtxservice.pl
* Spare parts available on: gtxservice.pl
* Запасные части на: gtxservice.pl

@GRAPHITE

GRAPHITEmov

graphite.pl

Szlifierka kątowa

Angle grinder / Winkelschleifer / Шлифмашина угловая / Шлифмашинака наріжна / Sarokcsiszoló / Maşină unghiulară de șlefuit / Bruska úhlová / Brúška uhlová / Kotni brusilnik / Kampinis šlifjuoklis / Leŋka slipmašina / Nurklivija / Ёглошайф / Brusilica kutna / Brusilica ugaona / Γωνιακός τροχός / Amoladora angular / Smerigliatrice angolare / Disco de limar p. cantos / Meuleuse d'angle / Verstekschuurmachine

1200W

Ref. 59G220



KOMPAKTOWY
KSZTAŁT
COMPACT
SHAPE

TRÓJSTRONNY
MONTAŻ
UCHWYTU
THREE-POSITION
HANDLE

ŁATWY
DOSTĘP
EASY
ACCESS

125 mm

3000-11000 min⁻¹

M14

części zamienne
spare parts / запчасті

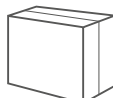

Ref.	L-W-H [mm]	Ⓢ [kg]	📦	EAN
59G220	450-130-100	3.8	0/4	5902062034670

2350W

Ref. 59G207



ŁAGODNY
ROZRUCH
SOFT
START

REGULOWANA
RĘKOJĘŚĆ
ADJUSTABLE
HANDLE

ŁATWY
DOSTĘP
EASY
ACCESS

230 mm

6500 min⁻¹

M14

części zamienne
spare parts / запчасті

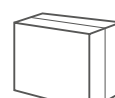

Ref.	L-W-H [mm]	Ⓢ [kg]	📦	EAN
59G207	525-175-125	6.0	0/2	5902062034656

2600W

Ref. 59G208



ŁAGODNY
ROZRUCH
SOFT
START

REGULOWANA
RĘKOJĘŚĆ
ADJUSTABLE
HANDLE

ŁATWY
DOSTĘP
EASY
ACCESS

230 mm

6500 min⁻¹

M14

części zamienne
spare parts / запчасті

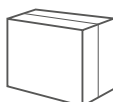

Ref.	L-W-H [mm]	Ⓢ [kg]	📦	EAN
59G208	575-175-125	6.9	0/2	5902062034663

2900W

Ref. 59G209



ŁAGODNY
ROZRUCH
SOFT
START

OGUMOWANE
UCHWYTY
SOFT GRIP
HANDLES

230 mm

6500 min⁻¹

M14

części zamienne
spare parts / запчасті

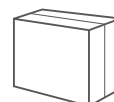

Ref.	L-W-H [mm]	Ⓢ [kg]	📦	EAN
59G209	550-180-150	5.9	0/2	5907558480733

GRAPHITE
POWER IN YOUR HANDS

3
YEARS
WARRANTY

3 lata gwarancji na WSZYSTKIE elektronarzędzia, urządzenia, akumulatory i ładowarki marki GRAPHITE. Regulamin dostępny na graphite.pl

3-year warranty on all power tools, devices, batteries and chargers. Terms and conditions are available on en.graphite.pl

Гарантія розповсюджується на весь електронструмент GRAPHITE, включаючи батареї. Подробна інформація доступна на сайті ru.graphite.pl

Polerka

Polisher / Poliermaschine / Полировальная машина / Машинка полирувальна / Polírozógér / Masina de lustruit / Leštička / Leštička / Polirka / Poliravimo staklės / Pūlēšanas mašīna / Poleerija / Машина за полиране / Aparat za poliranje / Polir mašina / Μηχανή σπλινδωμάτος / Pulidora / Lucidatore / Aparelho polidor / Polisseuse / Polijstmachine

1100W

Ref. 59G244



Ref.	L-W-H [mm]	Ⓛ [kg]	📦	EAN
59G244	445-180-136	3.6	0/4	5902062503589

1300W

Ref. 59G243



Ref.	L-W-H [mm]	Ⓛ [kg]	📦	EAN
59G243	480-170-120	3.9	1/4	5902062994967

Szlifierka prosta

Straight grinder / Schleifer gerade / Машина шлифовальная прямая / Машинка шлифовальная прямая / Egyenes csiszoló / Polizor simplu / Přímá bruska / Priama brúska / Premi brusilnik / Tiesinis šlifuoškis / Taisna stipmašina / Lihtlihvija / Шлайфмашина простая / Ravna brusilica / Obična brusilica / Τριβείο απλό / Lijadora recta / Smergliatrice dritta / Lixadeira reta / Meule droite / Rechte slijper

710W

Ref. 59G071



Ref.	L-W-H [mm]	Ⓛ [kg]	📦	EAN
59G071	405-135-100	2.5	0/6	5902062004642



10*
YEARS
SPARE PARTS
AVAILABILITY

* Części zamienne dostępne na: gtxservice.pl
* Spare parts available on: gtxservice.pl
* Запасные части на: gtxservice.pl

@GRAPHITE

GRAPHITEmov

graphite.pl

Bruzdownica

Wall Chaser / Nutfräse / Штроборез / Штроборіз / Falhoronymaró gép / Mašina de tăiat caneluri / Drážkovací frézka / Drážkovacia fréza / Zidni rezalnik / Műro freza / Rievgrieznis / Soonelõikur / Фреза за канали в бетон / Pila za precizno rezanje / Mašina za pravljenej brazda / Φρέζα αυλακώσεων / Rozadora / Intagliatore da muro / Máquina de raiar canos / Rainureuse / Muurfrees

1320W

Ref. 59G370

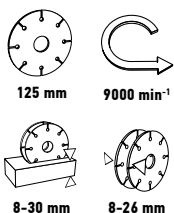

części zamienne
spare parts / запчасті



Ref.	L-W-H [mm]	Ⓢ [kg]	📦	EAN
59G370	400-270-230	6.5	0/3	5902062593702

Tarcze do bruzdownicy

Discs for wall chaser / Scheiben für Furchenmaschine / Диски для обработки борозд / Диски до штроборіза / Falhoronymaró tárcsák / Discuri pentru maşină de tăiat canale / Kotouče pro drážkovací frézku / Kotúče drážkovacej brúsky / Plošče za zidne utorne rezalnike / Diskai siūlių pjovimui / Rievu apršādes diski / Lihvmasina kettad / Дискове за браздачка / Ploče za gladalico / Ploče za brazdanje / Δίσκοι για επεξεργασία αυλακώσεων / Discos para rozadora / Dischi per fresatrice per muratura / Discos para máquina de raiar canos / Disques à rainureuse / Schijven voor muurfrees

Ref. K/59G370-T

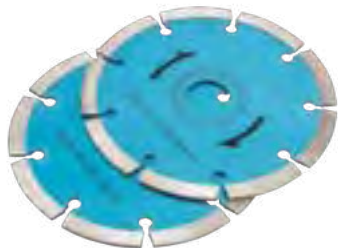

Ref.	Info	Ⓢ [kg]	📦	EAN
K/59G370-T	x2	0.26	0/1	5902062065902

Tarcza zespolona

Diamond compound blade / Verbund-Diamantscheibe / Алмазный диск / Диск діамантовий подвійний / Integrált gyémánt vágótárcsa / Disc diamantat sinterizat / Diamantový kombinovaný kotouč / Spojený diamantový kotúč / Kompozitna diamantna rezalna plošča / Universalusdeimantinis diskas / Kombinētais dimanta disks / Komplektnie teemantketas / Приєднаний діамантний диск / Dijamantna rezna ploča / Dijamantska ploča složena / Διαμαντόδισκος / Hoja de diamante unida / Multidisco diamatato / Disco de diamante integrado / Disque diamanté incorporé / Gesegmenteerde diamantschijf

Ref. K111786



Ref.	L-W-H [mm]	Ⓢ [kg]	📦	EAN
K111786	155-155-35	1.0		5902062505590

2400W

Ref. 59G371

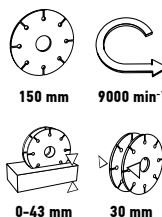

części zamienne
spare parts / запчасті



Ref.	L-W-H [mm]	Ⓢ [kg]	📦	EAN
59G371	550-200-340	11.0	0/2	5902062503596



GRAPHITE
POWER IN YOUR HANDS

3
YEARS
WARRANTY

3 lata gwarancji na WSZYSTKIE elektronarzędzia, urządzenia, akumulatory i ładowarki marki GRAPHITE. Regulamin dostępny na graphite.pl
3-year warranty on all power tools, devices, batteries and chargers. Terms and conditions are available on en.graphite.pl
Гарантия распространяется на весь электроинструмент GRAPHITE, включая батареи. Подробная информация доступна на сайте ru.graphite.pl

Nożyce do blachy

Sheet metal nibbler / Blechscherer / Ножницы по металлу / Ножици вирубни / Lemezvágógép / Foarfeca pentru tablă / Nůžky na plech / Nožnice na plech / Škarje za pločevino / Skardos žirkklės / Šķēres skārdam / Ножици за ламарина / Glodalica za lim / Makaze za lim / Ψαλίδι μετάλλου / Cortador para chapa / Cesoia / Tesoura para chapas / Cisaille coupe-tôle / Schaar voor blikplaat

500W

Ref. 59G401



ALUMINIOWY KORPUS
ALUMINUM BODY

LATWY DOSTĘP
EASY ACCESS

STEEL /AL
max 1.6/2.5 mm

2000 min⁻¹

UNIVERSALNY SYSTEM CIĘCIA
UNIVERSAL CUTTING SYSTEM

5 m



części zamienne
spare parts / запчасті



Ref.	L-W-H [mm]	☐ [kg]	📦	EAN
59G401	390-265-105	3.5	0/5	5902062594013

Komplet: stempel i matryca

Kit: punch and die / Im Satz enthalten: Stempel und Matrize / Набор: пуансон и матрица / Комплект: пуансон і матриця / Lemezvágó készlet / Set: poanson și matrița / Sada: razník a matrice / Súprava: razník a matrice / Komplet: pestič in matrica / Rinkiny: štampos ir matrica / Komplekts: puansons un matrica / Templi ja matriitsi komplekt / Комплект: щемпел и матрица / Set: rezivo i matrica / Komplet: žig i matrica / Σετ: ζουμπάς και μήτρα / Juego: perforador y troquel / Punzone e matrice / Jogo: cunha e matriz / Jeu : poinçon et matrice / Set: stempel en matrijs

Ref. 59G401-30



Ref.	Info	☐ [kg]	📦	EAN
59G401-30	for 59G401	0.03	0/1	5902062594310

Komplet noży do blachy

Set of shear blades / Messersatz für Blechscherer / Комплект сменных ножей к электроножицам / Комплект ножица до вирубних ножици / Lemezvágó készlet / Set de cuțite pentru tablă / Sada nožů na plech / Súprava čepeľí na plech / Komplet rezil za škarje za pločevino / Komplektas ašmenų / skardos kirpimui / Metāla lokšņu nažu komplekts / Plekiliōketerade komplekti / Комплект сменяемі ножові за ножици ламарина / Set noževa za lim / Komplet sečiva za lim / Σετ μαχαηριών για λαμαρινοψαλίδο / Juego de cuchillas para cortadores de chapa / Set lame per lamiera / Jogo de lâminas para cortar chapas / Jeu de couteaux pour tôle / Set van messen voor blikplaat

Ref. 59G402-30



Ref.	Info	☐ [kg]	📦	EAN
59G402-30	for 59G402	0.03	0/1	5902062594327

500W

Ref. 59G402



UNIVERSALNY SYSTEM CIĘCIA
UNIVERSAL CUTTING SYSTEM

STEEL /AL
max 2.5/3 mm

1800 min⁻¹

ALUMINIOWY KORPUS
ALUMINUM BODY

5 m



części zamienne
spare parts / запчасті

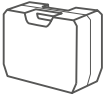

Ref.	L-W-H [mm]	☐ [kg]	📦	EAN
59G402	380-105-300	4.0	0/5	5902062594020

Szlifierka stołowa

Bench grinder / Tischschleifmaschine / Машина шлифовальная настольная / Шліфмашина верстатна / Kőszörögép / Masina de slefuit de banc / Stolní bruska / Stoolová brúška / Namizni brusilnik / Stacionarus galastuvus / Galda slipmašina / Lauakäi / Настилен абрухт / Stolna brusilica / Stona brusilica / Επιτραπέζιο τρίβείο / Amoladora de banco / Smerigliatrice da banco / Disco de limar de mesa / Meuleuse d'établi / Tafelschuurmachine

370W

Ref. 59G383



PRZYRZĄD DO RÓWNIANIA TARCZY
WHEEL DRESSER

OŚWIETLENIE
LIGHTING

12,7/150 mm

WŁĄCZNIK ELEKTROMAGNETYCZNY
ELECTROMAGNETIC SWITCH

2980 min⁻¹



części zamienne
spare parts / запчасті

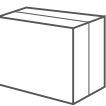

Ref.	L-W-H [mm]	☐ [kg]	📦	EAN
59G383	430-250-270	11.1	0/1	5902062593832

10* YEARS
SPARE PARTS
AVAILABILITY

* Części zamienne dostępne na: gtxservice.pl
* Spare parts available on: gtxservice.pl
* Запасные части на: gtxservice.pl

@GRAPHITE

GRAPHITEmov

graphite.pl

Pilarka szablowa

Sabre saw / Motorstichsäge / Сабельная пила / Пилка шабельна / Mini szúrófűrész / Ferästräu sabie / Šavlová pila / Chvostová pila / Sabljasta žaga / Tiesinis pjūklas / Zobenzägis / Saabelsaag / Саблен трион / Sabljasta pila / Sabljasta testera / Σαβόσαγα / Sierra de vaivén / Mini sega a gattuccio / Serra de sabre / Scie à sabre / Sjabelzaag

350W

Ref. 58G960



PLYNNA REGULACJA
OBROTÓW
VARIABLE
SPEED

BLOKADA
WŁĄCZNIKA
SWITCH
LOCK

BEZNRZEDZIOWA
WYMIANA
BRZESZCZOTU
TOOLLESS BLADE
REPLACEMENT

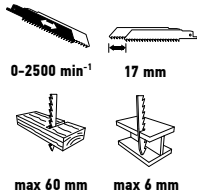

części zamienne
spare parts / запчасті



Ref.	L-W-H [mm]	Ⓢ [kg]	📦	EAN
58G960	365-95-230	2.9	0/6	5902062589606

900W

Ref. 58G971



BEZNRZEDZIOWA
WYMIANA
BRZESZCZOTU
TOOLLESS BLADE
REPLACEMENT

PLYNNA REGULACJA
OBROTÓW
VARIABLE
SPEED

OBROTOWA
REKOJEŚĆ
ROTATING
HANDLE

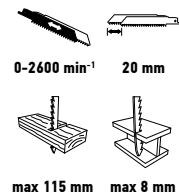

części zamienne
spare parts / запчасті

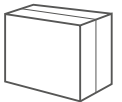

Ref.	L-W-H [mm]	Ⓢ [kg]	📦	EAN
58G971	470-90-220	3.1	0/6	5902062015716

Wyrzynarka

Jigsaw / Schweifsäge / Лобзик / Електролобзик / Dekorírfűrész / Masina de decupat / Kmitací pila / Priamočiara pila / Vbodna žaga / Siaurapijūklis / Figūržāģis / Tikksaag / Ажурна дървообработваща машина / Ubodna pila / Testera / Σέα / Sierra de calar / Seghetto alternativo / Máquina de entalhar / Scie sauteuse / Decoupeerzaag

450W

Ref. 58G047



PLYNNA REGULACJA
OBROTÓW
VARIABLE
SPEED

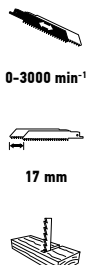

KONTROLKA
ZASILANIA
POWER
INDICATOR

OŚWIETLENIE
LIGHTING

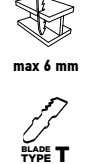

części zamienne
spare parts / запчасті

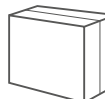

Ref.	L-W-H [mm]	Ⓢ [kg]	📦	EAN
58G047	223-212-78	1.8	0/10	5902062058546

650W

Ref. 58G067



PLYNNA REGULACJA
OBROTÓW
VARIABLE
SPEED

FUNKCJA
PODRZYNANIA
PENDULUM
FUNCTION

SYSTEM
WYDMUCHU PYŁU
ON/OFF
DUST BLOWER

OŚWIETLENIE
LIGHTING

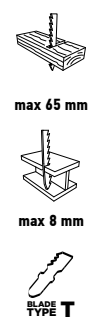
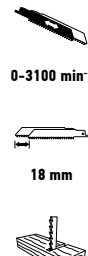

części zamienne
spare parts / запчасті

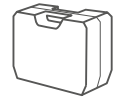

Ref.	L-W-H [mm]	Ⓢ [kg]	📦	EAN
58G067	350-293-115	3.4	0/4	5902062057723

GRAPHITE
POWER IN YOUR HANDS

3
YEARS
WARRANTY

3 lata gwarancji na WSZYSTKIE elektronarzędzia, urządzenia, akumulatory i ładowarki marki GRAPHITE. Regulamin dostępny na graphite.pl
3-year warranty on all power tools, devices, batteries and chargers. Terms and conditions are available on en.graphite.pl
Гарантія розповсюджується на весь електронструмент GRAPHITE, включаючи батареї. Подробна інформація доступна на сайті ru.graphite.pl

Wyrzynarka

Jigsaw / Schweifsäge / Лобзик / Електролобзик / Dekorírfűrés / Masina de decupat / Kmitací pila / Ριαιτοσίαγα πiλα / Vbođna žaga / Σταυροπύκλις / Figürzägis / Tikksaag / Ажурна дървообработваща машина / Ubođna pila / Testera / Σέγα / Sierra de calar / Seghetto alternativo / Máquina de entalhar / Scie sauteuse / Decuopeerzaag

800W

Ref. 58G077



Ref.	L-W-H [mm]	kg	Box	EAN
58G077	350-293-115	3.6	0/4	5902062057730

Pilarka tarczowa

Circular saw / Kreissäge / Дисковая пила / Пилна дискова / Körfűrés / Circular / Kotoučová pila / Okružná pila / Krožna žaga / Diskinis pjūklas / Ripzägis / Ketassaag / Циркуляр дисков / Kružna pila / Kružna testera / Διακοπiόvo / Sierra circular / Sega circolare / Plainade disco / Scie circulaire / Schijfzaag

1200W

Ref. 58G486



Ref.	L-W-H [mm]	kg	Box	EAN
58G486	340-255-250	4.4	0/5	5902062584861

Pilarka tarczowa

Circular saw / Kreissäge / Дисковая пила / Пилна дискова / Körfűrés / Circular / Kotoučová pila / Okružná pila / Krožna žaga / Diskinis pjūklas / Ripzägis / Ketassaag / Циркуляр дисков / Kružna pila / Kružna testera / Διακοπiόvo / Sierra circular / Sega circolare / Plainade disco / Scie circulaire / Schijfzaag

1200W

Ref. 58G488



Ref.	L-W-H [mm]	kg	Box	EAN
58G488	380-190-320	6.6	0/5	5902062584885

1200W

Ref. 58G491



Ref.	L-W-H [mm]	kg	Box	EAN
58G491	360-235-240	4.6	0/4	5902062037510

10*
YEARS
SPARE PARTS
AVAILABILITY

* Części zamienne dostępne na: gtxservice.pl
 * Spare parts available on: gtxservice.pl
 * Запасные части на: gtxservice.pl

@GRAPHITE

GRAPHITEmov

graphite.pl

Pilarka tarczowa

Circular saw / Kreissäge / Дисковая пила / Пилка дискова / Körfűrész / Circular / Kotoučová pila / Okružná pila / Krožna žaga / Diskinis pjūklas / Ripzāģis / Ketassaag / Циркуляр дисков / Kružna pila / Kružna testera / Διακοπρίο / Sierra circular / Sega circolare / Plainade disco / Scie circulaire / Schijzaag

1500W

Ref. 58G492



REGULOWANA GŁĘBOKOŚĆ CIĘCIA
ADJUSTABLE CUTTING DEPTH



Ø 185/20 mm



5800 min⁻¹

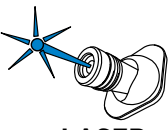

LASER

max 65 mm



części zamienne
spare parts / запчасті

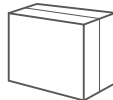

Ref.	L-W-H [mm]	☒ [kg]	☒	EAN
58G492	362-245-265	5.7	0/4	5902062037527

1800W

Ref. 58G493



REGULOWANA GŁĘBOKOŚĆ CIĘCIA
ADJUSTABLE CUTTING DEPTH



Ø 210/30 mm



5000 min⁻¹



LASER

max 73 mm



części zamienne
spare parts / запчасті

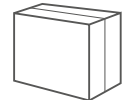

Ref.	L-W-H [mm]	☒ [kg]	☒	EAN
58G493	400-280-275	6.9	0/4	5902062037534

Pilarko-zagłębiarka

Plunge cut track saw / Tauch-/kreissäge / Погружная пила / Пилка заглибна / Merülő körfűrész / Ferästräu – circular multi - cutter / Роторна пилка / Роторна пилка / Роторна кроžна žaga / Iğilimino pjūklas / Iegremdējamais ripzāģis / Потанящ се циркуляр / Pila za uranjanje / Potopna krožna žaga / Βυθίζομενο διακοπρίο / Sierra circular de inmersión / Sega circolare ad immersione / Slagsleutel

1200W

Ref. 58G495



45° REGULOWANY KĄT CIĘCIA
ADJUSTABLE CUTTING ANGLE



REGULOWANA GŁĘBOKOŚĆ CIĘCIA
ADJUSTABLE CUTTING DEPTH



Ø 165/20 mm



2200-5200 min⁻¹ max 57 mm



części zamienne
spare parts / запчасті

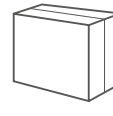

Ref.	L-W-H [mm]	☒ [kg]	☒	EAN
58G495	370-255-260	5.4	1/2	5902062044112

Szyna prowadząca do zagłębiarki

Guide for sink saw / Führungsschiene für Vertieffräse / Шина направляющая для погружной пилы / Шина напрямна до заглибної пилки / Vezetősín merülőkörfűrészhez / Sina ghidaj / Vodící lišta pro rоторnou pilu / Vodiaca koľajnička do rоторnej pily / Vodilna praga za potopno žago / Kreipiančioji liniuotė iğilimino pjūklui / Disku žaģa vadotne / Soonesae juhtsiin / Vodeща шина за дрaга / Sina vodilica za / Vodeći žleb uranjajuće testere / Λάμα προιονού ακριβείας / Guia para sierra de incisión / Binario di guida per sega ad affondamento / Barra guiadora / Rail de guidage pour scie plongeante / Geleiderail voor cirkelzaag

Ref. 58G495-732



Ref.	Info	☒ [kg]	☒	EAN
58G495-732	2 x 700 mm	2.73	1/3	5902062044143

Ref. 58G495-731



Ref.	Info	☒ [kg]	☒	EAN
58G495-731	1400 mm	2.64	1/5	5902062044136

GRAPHITE
POWER IN YOUR HANDS

3
YEARS
WARRANTY

3 lata gwarancji na WSZYSTKIE elektronarzędzia, urządzenia, akumulatory i ładowarki marki GRAPHITE. Regulamin dostępny na graphite.pl
3-year warranty on all power tools, devices, batteries and chargers. Terms and conditions are available on en.graphite.pl
Гарантия распространяется на весь электроинструмент GRAPHITE, включая батареи. Подробная информация доступна на сайте ru.graphite.pl

Łącznik do szyn prowadzących

Guide rails connector / Verbindungsstück für Führungsschienen / Соединитель для ведущих рельсов / З'єднувальна ланка для напрямних шин / Összekötőelem vezetősinékhez / Conector de şine de ghidare / Spojovací tyč pro vodičí lišty / Spoj pre vodiace kolajničky / Spoj za vodilne proge / Kreipiančiųjų bėgelių jungtis / Vadsliežu savienotājs / Juhtsiinide ühendus / Съединител за направляващи шини / Spona za vodilice / Spojnica za šine / Συνδεσμος για ράγες-οδηγούς / Conexión para guías / Giunto per binari di guida / União de barras guidoras / Raccord pour rails de guidage / Connector van geleiderrails

Ref. 58G495-733



Ref.	Info	📦 [kg]	📦	EAN
58G495-733	for 58G495-731, 58G495-732, 58G023-732			5902062065384

Zaciski

Clips / Klemmen / Зажимы / Затиски / Szorítók / Cleme / Svorky / Kliešte / Sponke / Spaustai, ilgi / Satvērēji / Klambri / Клеми за пръстени / Stezaljke / Stezači, stezaljke / Σφιγκτήρες / Abrazaderas / Morsetti / Abraçadeira / Bornes / Lange klemmen

Ref. 58G495-144



Ref.	Info	📦 [kg]	📦	EAN
58G495-144	x2	0.3	2/50	5902062044129

Urządzenie wielofunkcyjne

Wall Chaser / Nutfräse / Штроборез / Штроборіз / Multifunkciós gép / Maşină de tăiat caneluri / Drážkovací frézka / Drážkovacia fréza / Zidni rezakník / Műro freza / Rievgrieznis / Sooneleikur / Фреза за канали в бетон / Pila za precizno rezanje / Mašina za pravljenej brazda / Φρέζα αυλακώσεων / Rozadora / Utensile multifunzione / Máquina de raiar canos / Rainureuse / Muurfrees

180W

Ref. 59G022



CIĘCIE I SZLIFOWANIE
CUTTING AND GRINDING

SYSTEM ODPROWADZANIA WIORÓW
DUST AWAY

KOMPAKTOWY KSZTAŁT
COMPACT SHAPE

20000 min⁻¹

2,8°

części zamienne
spare parts / запчасті

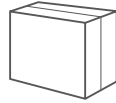

Ref.	L-W-H [mm]	📦 [kg]	📦	EAN
59G022	340-105-105	1.8	0/10	5902062008923

Urządzenie wielofunkcyjne

Wall Chaser / Nutfräse / Штроборез / Штроборіз / Multifunkciós gép / Maşină de tăiat caneluri / Drážkovací frézka / Drážkovacia fréza / Zidni rezakník / Műro freza / Rievgrieznis / Sooneleikur / Фреза за канали в бетон / Pila za precizno rezanje / Mašina za pravljenej brazda / Φρέζα αυλακώσεων / Rozadora / Utensile multifunzione / Máquina de raiar canos / Rainureuse / Muurfrees

180W

Ref. 59G020



CIĘCIE I SZLIFOWANIE
CUTTING AND GRINDING

SYSTEM ODPROWADZANIA WIORÓW
DUST AWAY

KOMPAKTOWY KSZTAŁT
COMPACT SHAPE

20000 min⁻¹

2,8°

części zamienne
spare parts / запчасті



Ref.	L-W-H [mm]	📦 [kg]	📦	EAN
59G020	350-80-280	2.8	0/5	5902062590206

300W

Ref. 59G021



SZYBKE MOCOWANIE
QUICK CHANGE

SYSTEM ODPROWADZANIA WIORÓW
DUST AWAY

KOMPAKTOWY KSZTAŁT
COMPACT SHAPE

15000-21000 min⁻¹

2,8°

części zamienne
spare parts / запчасті



Ref.	L-W-H [mm]	📦 [kg]	📦	EAN
59G021	350-90-290	3.3	0/4	5902062005113

10* YEARS
SPARE PARTS
AVAILABILITY

* Części zamienne dostępne na: gtxservice.pl
* Spare parts available on: gtxservice.pl
* Запасные части на: gtxservice.pl

📌 @GRAPHITE

📺 GRAPHITEmov

graphite.pl

Szlifierka mimośrodowa

Orbital sander / Excenterschleifmaschine / Эксцентриковая шлифовальная машина / Шліфмашинка ексцентрикова / Excentercsiszoló / Masina de slefuit excentrica / Excentrická bruska / Excentrická brúška / Ekscentrični brusilnik / Ekscentrinis šlifuoškis / Ekscentra slīpmašīna / Eksstentriklihvija / Шлайфмашина ексцентрична / Vibracijska bušilica / Ekscentrična brusilica / Εκκεντρο τριβείο / Lijadora excéntrica / Levigatrice roto-orbitale / Disco de limar / Meuleuse excentrique / Excenter schuurmachine

240W

Ref. 59G343



MOCOWANIE NA RZEP
HOOK-AND-LOOP SYSTEM

SYSTEM ODYSANIA PYŁU
DUST AWAY

KOMPAKTOWY KSZTAŁT
COMPACT SHAPE

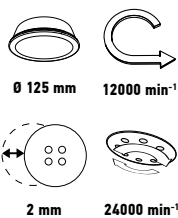

części zamienne
spare parts / запчасті

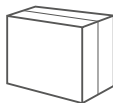

Ref.	L-W-H [mm]	kg	Box	EAN
59G343	220-130-160	1.8	0/4	5902062000347

430W

Ref. 59G347



MOCOWANIE NA RZEP
HOOK-AND-LOOP SYSTEM

SYSTEM ODYSANIA PYŁU
DUST AWAY

PLYNNA REGULACJA OBROTÓW
VARIABLE SPEED

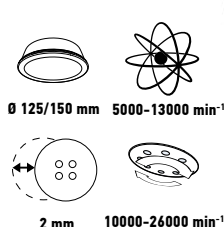

części zamienne
spare parts / запчасті



Ref.	L-W-H [mm]	kg	Box	EAN
59G347	385-150-290	2.3	0/4	5902062000330

Szlifierka taśmowa

Belt sander / Bandschleifmaschine / Ленточная шлифовальная машина / Шліфмашинка стрічкова / Szalagcsiszoló / Masina de slefuit cu banda / Pásová bruska / Pásová brúška / Tračni brusilnik / Juostinis šlifuoškis / Lentas slīpmašīna / Lintlihvija / Шлайфмашина ексцентрична / Tračna brusilica / Tračasta brusilica / Ταινιοτριβείο / Lijadora de banda / Levigatrice a nastro / Disco de limar de fita / Meuleuse à bande / Bandschuurmachine

800W

Ref. 59G392



REGULOWANA RĘKOJEŚĆ
ADJUSTABLE HANDLE

BLOKADA WŁACZNIKA
SWITCH LOCK

ODCHYLANA OSŁONA PASA ŚCIERNEGO
SANDING BELT COVER OPENING

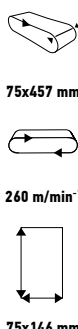

części zamienne
spare parts / запчасті

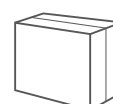

Ref.	L-W-H [mm]	kg	Box	EAN
59G392	350-160-160	3.5	0/6	5902062593924

800W

Ref. 59G394



PLYNNA REGULACJA OBROTÓW
VARIABLE SPEED

REGULOWANA RĘKOJEŚĆ
ADJUSTABLE HANDLE

BLOKADA WŁACZNIKA
SWITCH LOCK

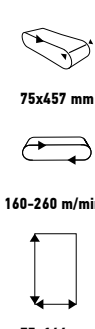

części zamienne
spare parts / запчасті



Ref.	L-W-H [mm]	kg	Box	EAN
59G394	420-185-275	4.9	0/4	5902062593948

10*
YEARS
SPARE PARTS
AVAILABILITY

* Części zamienne dostępne na: gtxservice.pl
* Spare parts available on: gtxservice.pl
* Запасные части на: gtxservice.pl

@GRAPHITE

GRAPHITEmov

graphite.pl

Szlifierka taśmowa

Belt sander / Bandschleifmaschine / Ленточная шлифовальная машина / Шліфмашина стрічкова / Szalagcsiszoló / Masina de slefuit cu banda / Pásová bruska / Pásová brúska / Tračni brusilnik / Juostinis šlifuoškis / Lentas slirpašina / Lintihvijja / Шліфмашина ексцентрична / Tračna brusilica / Trakasta brusilica / Ταινιοτριβείο / Lijadora de banda / Levigatrice a nastro / Disco de limar de fita / Meuleuse à bande / Bandschuurmachine

900W

Ref. 59G395

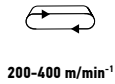

Ref.	L-W-H [mm]	Ⓛ [kg]	📦	EAN
59G395	475-165-160	4.6	0/4	5902062049483

Strug

Planer / Hobel / Рубанок / Гембель / Gyalu / Hoblovka / Hoblík / Oblič / Oblius / Èvele / Höövel / Ренде / Blanjalica / Rende / Blanja / Πλάνη / Cepillo / Pialletto / Garlopa / Rabot / Schaafmachine

1300W

Ref. 59G680

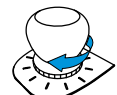

Ref.	L-W-H [mm]	Ⓛ [kg]	📦	EAN
59G680	390-200-220	6.1	0/2	5902062596802

Strug

Planer / Hobel / Рубанок / Гембель / Gyalu / Hoblovka / Hoblík / Oblič / Oblius / Èvele / Höövel / Ренде / Blanjalica / Rende / Blanja / Πλάνη / Cepillo / Pialletto / Garlopa / Rabot / Schaafmachine

850W

Ref. 59G678



Ref.	L-W-H [mm]	Ⓛ [kg]	📦	EAN
59G678	330-180-200	3.6	0/6	5902062596789

Noże do struga

Planer blades / Hobelmesser / Ножи для электрорубанка / Ножи до гембля / Gyalukések / Cuițe pentru rândea / Nože do hoblíku / Hobľovacie nože / Rezila za skobeljnik / Peiliiai obliui / Èvelnaži / Saeterad / Ножове на ренде / Noževi za blanjalicu / Makaze za rende / Λεπίδες ηλεκτρικής πλάνης / Cuchillas para cepillo eléctrico / Lame per pialletto / Facas p. Garlopa / Couteaux à rabot / Bladen voor schaafmachine

Ref. 59G678-30

Ref. 59G679-30

HSS



Ref.	L [mm]	Ⓛ [kg]	📦	EAN
59G678-30	82	0.03	0/1	5902062596734
59G679-30	82	0.03	0/1000	5902062221353

Ref. 59G680-30

HSS

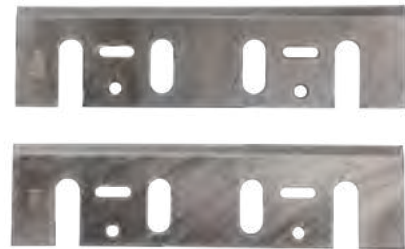

Ref.	L [mm]	Ⓛ [kg]	📦	EAN
59G680-30	110	0.06	0/500	5902062478429

GRAPHITE
POWER IN YOUR HANDS

3
YEARS
WARRANTY

3 lata gwarancji na WSZYSTKIE elektronarzędzia, urządzenia, akumulatory i ładowarki marki GRAPHITE. Regulamin dostępny na graphite.pl
3-year warranty on all power tools, devices, batteries and chargers. Terms and conditions are available on en.graphite.pl
Гарантия распространяется на весь электроинструмент GRAPHITE, включая батареи. Подробная информация доступна на сайте ru.graphite.pl

Miniszlifierka

Minigrinder / Minischleifer / Мини-шлифовальная машина / Шліфмашина міні / Multifunkcyjna csiszáló / Minipolizor / Minibruska / Mini brusilica / Mini brusilica / Mini brusilnik / Mini šljufoklis / Mini-slipmašina / Otslihviya / Мини шлайфмашина / Mini brusilica / Mini brusilica / Микро τρίβείο / Mini amoladora recta / Mini smerigliatrice / Esmerilhadora mini / Mini-ponceuse / Minischuurmachine

170W

Ref. 59G019



ELEKTRONICZNIE REGULOWANE OBROTY
DIGITAL SPEED ADJUSTMENT



DODATKOWA REKOCJEŚĆ
ADDITIONAL HANDLE



GIĘTKI WAŁEK
FLEXIBLE SHAFT



8000-35000 min⁻¹



Ø max 35 mm 1,4; 2,4; 3,2 mm



części zamienne
spare parts / запчастки

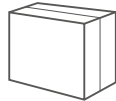

Ref.	L-W-H [mm]	Ⓜ [kg]	📦	EAN
59G019	355-140-175	2.5	0/4	5902062005106

Frezarka górnwrzescionowa

Router / Oberfräse / Станок фрезерный / Верстат фрезувальний / Felsőmaró / Trasator / Frézka horná / Fréza horná / Rezkalnik / Freza / Freze / Profílfreespínk / Фреза / Glodalica / Φρέζα κοπής / Fresadora de superficie / Fresatrice verticale / Fresa de fuso superior / Fraiseuse à broche supérieure

1300W

Ref. 59G717



PLYNNA REGULACJA OBROTÓW
VARIABLE SPEED

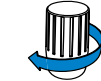

REGULACJA GŁĘBOKOŚCI
DEPTH CONTROL

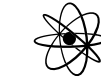

11000-28000 min⁻¹

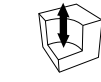

max 55 mm



6, 8, 12 mm



części zamienne
spare parts / запчастки

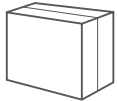

Ref.	L-W-H [mm]	Ⓜ [kg]	📦	EAN
59G717	280-160-365	5.0	0/4	5902062037541

Opalarka

Hot air gun / Sengmaschine / Термофен / Фен / Hőlégfúvó / Masina de parlit / Opalovací pistole / Opalovacia pištoľ / Fen / Techninis fenas / Celtniecības fēns / Kuuma puhur / Пусмонем за горещ въздух / Puhala vrućeg zraka / Fen / Πιστόλι θερμού αέρα / Decapador por aire caliente / Pistola ad aria calda / Soprador de ar quente / Décapeur thermique / Verfstripper

2000W

Ref. 59G522



REGULACJA ZAKRESU TEMPERATURY
TEMPERATURE ADJUSTMENT

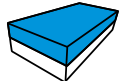

ZABEZPIECZENIE BIMETALOWE
BIMETALLIC PROTECTION



I: 300 U/min
II: 150 U/min
III: 500 U/min



I: 25°C
II: 350°C
III: 550°C



części zamienne
spare parts / запчастки



Ref.	L-W-H [mm]	Ⓜ [kg]	📦	EAN
59G522	310-100-290	1.9	0/5	5902062595225

2000W

Ref. 59G524



REGULACJA ZAKRESU TEMPERATURY
AIR TEMPERATURE ADJUSTMENT

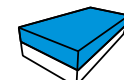

ZABEZPIECZENIE BIMETALOWE
BIMETALLIC PROTECTION



I: 350 U/min
II: 350 U/min
III: 550 U/min

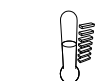

I: 25°C
II: 80-600°C
III: 80-600°C



części zamienne
spare parts / запчастки



Ref.	L-W-H [mm]	Ⓜ [kg]	📦	EAN
59G524	320-95-300	1.9	0/5	5902062595249

10*
YEARS
SPARE PARTS
AVAILABILITY

* Części zamienne dostępne na: gtxservice.pl
* Spare parts available on: gtxservice.pl
* Запасные части на: gtxservice.pl

@GRAPHITE

GRAPHITEmov

graphite.pl

Pilarka ukosowa

Mitre saw / Schrägsäge / Торцово-усовочная пила / Пилка-стусло / Gérvágógép / Frastrau oblig p/t lemn / Pokosová pila / Pokosová pila / Zajeralna žaga / Skersavimo pjūklas / Leņķa zāģis / Nurgasaag / Циркуляр скосявац / Nagibna pila / Testera za zasecanje / Φαλτοσπίριο / Ingletadora / Troncatrice / Plaina inclinada / Scie à chanfreiner / Verstekzaag

1400W

Ref. 59G800

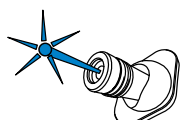

LASER

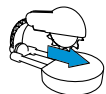

FUNKCJA POSUWU
RAMIENIA PILARKI
SLIDE MOVE



ALUMINIOWA
BAZA
ALUMINIUM
BASE



Ø 185/16 mm



max 50x210 mm



5000 min⁻¹



0-45°

części zamienne
spare parts / запчасти

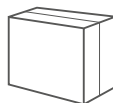

Ref.	L-W-H [mm]	Ⓜ [kg]	📦	EAN
59G800	640-370-405	12.0	0/1	5902062024367

1800W

Ref. 59G812

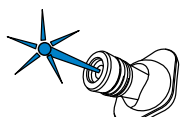

LASER

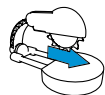

FUNKCJA POSUWU
RAMIENIA PILARKI
SLIDE MOVE



ALUMINIOWA
BAZA
ALUMINIUM
BASE



Ø 254/30 mm



max 90x280 mm



4800 min⁻¹



0-45°

części zamienne
spare parts / запчасти

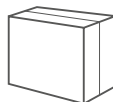

Ref.	L-W-H [mm]	Ⓜ [kg]	📦	EAN
59G812	820-460-420	19.0	0/1	5902062004673

1800W

Ref. 59G806

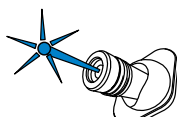

LASER

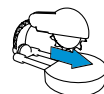

FUNKCJA POSUWU
RAMIENIA PILARKI
SLIDE MOVE



ALUMINIOWA
BAZA
ALUMINIUM
BASE



Ø 210/30 mm



max 65x260 mm



4800 min⁻¹



0-45°

części zamienne
spare parts / запчасти

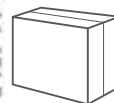

Ref.	L-W-H [mm]	Ⓜ [kg]	📦	EAN
59G806	745-435-425	16.0	0/1	5902062004666

Pilarka uniwersalna

Combination saw / Universalsägemaschine / Пила универсальная / Пилка циркулярна универсальна / Univerzálnis gérvágó / Ferástráu universal / Univerzálni pila / Univerzálna pila / Univerzalna mizna žaga / Universalus pjūklas / Univeršālais zāģis / Universaalsaag / Универсален трион / Univerzalna pila / Univerzalna testera / Διακοπτήριο γενικής χρήσης / Sierra universal / Troncatrice combinata / Plainauniversal / Scie universelle / Universele zaag

1600W

Ref. 59G801



2 FUNKCJE
2 FUNCTIONS



ALUMINIOWA
BAZA
ALUMINIUM
BASE



Ø 254/30 mm



max 70x150 mm



4800 min⁻¹



0-45°

części zamienne
spare parts / запчасти

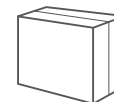

Ref.	L-W-H [mm]	Ⓜ [kg]	📦	EAN
59G801	585-400-530	17.0	0/1	5902062037503

GRAPHITE
POWER IN YOUR HANDS

3
YEARS
WARRANTY

3 lata gwarancji na WSZYSTKIE elektronarzędzia, urządzenia, akumulatory i ładowarki marki GRAPHITE. Regulamin dostępny na graphite.pl
3-year warranty on all power tools, devices, batteries and chargers. Terms and conditions are available on en.graphite.pl

Гарантия распространяется на весь электроинструмент GRAPHITE, включая батареи. Подробная информация доступна на сайте ru.graphite.pl

Przecinarka do glazury

Tile cutter / Fliesensäge / Плиткорез электрический / Плиткоріз електричний / Csepevágógép / Tájietor placă / Pila na glazuru / Rezačka dlažby stolová / Žaga za ploščice / Plytelij pjaustyklė / Flізгрієзєjs / Plaaidiõkur / Циркуляр / Pila za ploščice / Stona testera / Κόφτης πλακιδίων / Cortador eléctrica de azulejos / Tagliapiastrelle elettrico / Serra para ladrilho / Scie à carrelage

1200W

Ref. 59G887

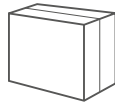
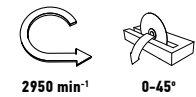
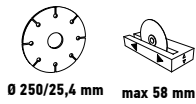
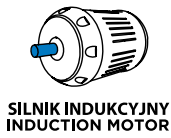

Ref.	L-W-H [mm]	Ⓢ [kg]	📦	EAN
59G887	1670-600-620	59.6	0/1	5902062888921

2600W

Ref. 59G873

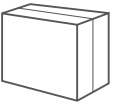
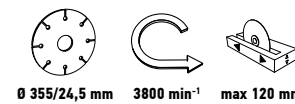

Ref.	L-W-H [mm]	Ⓢ [kg]	📦	EAN
59G873	355-565-435	19.0	0/1	5902062504890

Szlifierka do gipsu

Drywall sander / Gipsschleifer / Машина шлифовальная для стен и потолков / Шліфмашинка по гіпсу / Falcsiszoló / Polizor pentru pereti ghips-carton / Bruska na sádrú / Brúska na sadru / Bruslinik za gips / Slifuoaktis gipsui / Slifmašina sienų griestu slifėšanai / Kipslihvija / Шлауфмашинка за гюпс / Brusilica za gips / Brusilica za gips / Λειαντήρας για τοίχους και ταβάνια / Amoladora para yeso / Levigatrice da muro / Disco de limar p. Gesso / Meuleuse à plâtre / Gipslijpmachine

600W

Ref. 59G261

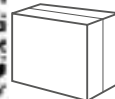
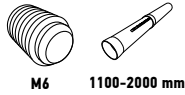
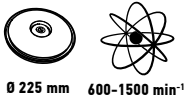

Ref.	L-W-H [mm]	Ⓢ [kg]	📦	EAN
59G261	1140-260-250	7.6	0/2	5902062592613

1050W

Ref. 59G262

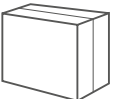
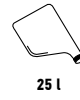

Ref.	L-W-H [mm]	Ⓢ [kg]	📦	EAN
59G262	660-270-160	5.8	0/2	5902062592620

10*
YEARS
SPARE PARTS
AVAILABILITY

* Części zamienne dostępne na: gtxservice.pl
* Spare parts available on: gtxservice.pl
* Запасные части на: gtxservice.pl

@GRAPHITE

GRAPHITEmov

graphite.pl

Odkurzacz warsztatowy

Workshop vacuum cleaner / Werkstattstaubsauger / Пылесос промышленный / Пилосос професійний / Porszívó / Aspirator atelier cu sistem vacuum / Dílenský vysávač / Dielenský vysávač / Industrijski sesalnik / Pramoninis siurblys / Rūpniecības putekļsūcējs / Tööstuslik tolmimeja / Промышленна прахосмукачка / Radionički usisavač / Industrijski usisivač / Ηλεκτρική σκούπα επαγγελματική / Aspirador / Aspiratore umido/secco / Aspirador de oficina / Aspireteur d'atelier / Werkplaatsstofzuiger

1500W

Ref. 59G607



DO PRACY Z PYŁEM
GIPSOWYM
GYPSUM
DUST SAFE



18 kPa



30 l



DO PRACY
NA SUCHO
I MOKRO
FOR DRY
AND WET
OPERATION



max 2000 W



4 m

GNIAZDO
PRZYŁĄCZENIOWE
ELECTRICAL
SOCKET



części zamienne
spare parts / запчасті



Ref.	L-W-H [mm]	⊘ [kg]	📦	EAN
59G607	355-355-610	10.0	0/1	5902062596079

Wąż przyłączeniowy

Connection hose / Anschluss Schlauch / Соединительный шланг / Шланг приєднвальний / Gégecső falcsiszolóhoz / Tub de racordare / Přípojná hadice / Přípojná hadica / Priključna cev / Prijungimo žarna / Savienotājšūtene / Ühendusoolik / Свързващ шланг / Priključna cijev / Priključno crevo / Συνδετικός εύκαμπος σωλήνας / Manguera de conexión / Tubo di aspirazione / Mangueira de ligação

Ref. 59G261-147
Ref. 59G606-147
Ref. 59G607-147
Ref. 59G607-147A



Ref.	📦	L [m]	📦	EAN
59G261-147	59G261	4	0/1	5902062478351
59G606-147	59G606	4	0/1	5902062221476
59G607-147	59G607, 59G608	2.1	0/1	5902062478382
59G607-147A	59G607, 59G608	4	0/1	5902062810151

Rura teleskopowa

Telescopic pipe / Teleskoprohr / Телескопическая трубка / Трубка телескопична / Tartozék porszívóhoz / Teavná telescopică / Teleskopická trubka / Teleskopická trubica / Teleskopska cev / Teleskopinis vamzdis / Teleskopiskā caurule / Teleskoortoru / Teleskopichna trǎba / Teleskopska cijev / Teleskopska cev / Τηλεσκοπικός σωλήνας / Tubo telescópico / Tubo telescópico / Tubo telescópico / Tube télescopique / Telescopische buis

Ref. 59G607-148



Ref.	📦	EAN
59G607-148	59G607, 59G608	0/50 5902062478399

1500W

Ref. 59G608



DO PRACY Z PYŁEM
GIPSOWYM
GYPSUM
DUST SAFE



18 kPa



40 l



DO PRACY
NA SUCHO
I MOKRO
FOR DRY
AND WET
OPERATION

max 2000 W



4 m

GNIAZDO
PRZYŁĄCZENIOWE
ELECTRICAL
SOCKET



części zamienne
spare parts / запчасті



Ref.	L-W-H [mm]	⊘ [kg]	📦	EAN
59G608	370-360-810	12.3	0/1	5902062024350

Końcówki robocze

Vacuum attachments / Saugdüsen / Рабочие насадки / Наконечники робочі / Munkavégző hegyek / Capete de lucru / Pracovní koncovky / Pracovné nástavce / Delovni nastavki / Darbinis antgalis / Darba uzgali / Tööotsakud / Работни накрайници / Radni nastavci / Radni nastavci / Μύτες εργασίας / Útiles / Terminali di lavoro / Acessórios / Embouts de travail / Eindstukken

Ref. 59G607-149
Ref. 59G607-149A
Ref. 59G607-149B
Ref. 59G607-149C



Ref.	📦	EAN
59G607-149	59G607, 59G608	0/25 5902062478405
59G607-149A	59G607, 59G608	5902062810120
59G607-149B	59G607, 59G608	5902062810137
59G607-149C	59G607, 59G608	5902062810144

Końcówki robocze

Vacuum attachments / Saugdüsen / Рабочие насадки / Наконечники робочі / Munkavégző hegyek / Capete de lucru / Pracovní koncovky / Pracovné nástavce / Delovni nastavki / Darbinis antgalis / Darba uzgali / Tööotsakud / Работни накрайници / Radni nastavci / Radni nastavci / Μύτες εργασίας / Útiles / Terminali di lavoro / Acessórios / Embouts de travail / Eindstukken

Ref. 59G607-150



Ref.	📦	EAN
59G607-150	59G607, 59G608	0/100 5902062478412

GRAPHITE
POWER IN YOUR HANDS

3
YEARS
WARRANTY

3 lata gwarancji na WSZYSTKIE elektronarzędzia, urządzenia, akumulatory i ładowarki marki GRAPHITE. Regulamin dostępny na graphite.pl
3-year warranty on all power tools, devices, batteries and chargers. Terms and conditions are available on en.graphite.pl
Гарантия распространяется на весь электроинструмент GRAPHITE, включая батареи. Подробная информация доступна на site.ru.graphite.pl

Worki do odkurzacza

Vacuum cleaner bags / Staubsaugerbeutel / Мешки-пылесборники / Мішки до пылесоса / Porszívósák / Saci pentru aspiratori de praf / Sáčky do vysávača / Vrečka do vysávača / Vreče za sesalniki / Maišeliai dulkių siurbliui / Putekšūcēja maisiņi / Tolmuimejakotid / Торби за прахосмукачки / Vrećice za usisavač / Vakuüm kese / Σάκοι συλλογής σκόνης / Bolsas para aspirador / Sacchetti per aspiratore / Sacos de aspirador / Sacs aspirateur

Ref. 59G606-145
Ref. 59G607-145
Ref. 59G608-145



Ref.				EAN
59G606-145	59G606	5	0/10	5902062221452
59G607-145	59G607	5	0/10	5902062478368
59G608-145	59G608	5	1/8	5902062025937

Filtr harmonijkowy

Pleated filter / Faltenfilter / Фильтр гофрированный / Фільтр кишеньковий / Szűrő porszívóhoz / Filtru în formă de armonică / Skládany filtr / Harmonikový filter / Filter harmonika / Gofruotas filtras / Vilņots filtrs / Lõõtsfilter / Нагънат филтър / Preklopní filter / Harmonika filter / Φίλτρο πλισέ / Filtro plegable / Filtro per gesso / Filtro / Filtre accordéon / Harmonica filter

Ref. 59G606-146
Ref. 59G607-146



Ref.			EAN
59G606-146	59G606	0/16	5902062468208
59G607-146	59G607, 59G608	0/16	5902062478375

Pilarka łańcuchowa spaliniowa

Gasoline chain saw / Kettensäge m. Verbrennungsmotor / Пила ценная бензиновая / Пилка ланцюгова бензинова / Lánzfűrész benzinmotoros / Ferestrău cu lanț cu motor / Motorová řetězová pila benzínová / Benzínová reťazová pila / Bencinska verižna žaga / Grandininis benzininis pjūklas / Benzina ķēžu zāģis / Kettsaag (bensiiniga) / Верижен трион бензинов / Lančana benzinska pila / Benzinska lančana testera / Βενζινοκίνητη αλυσοπίλοιο / Motosierra / Moto sega / Electro-serra / Scie à bois à essence / Benzine kettingzaag

0.9kW (1.22KM)

Ref. 58G950

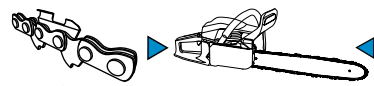

ŁAŃCUCH OREGON OREGON CHAIN

KOMPAKTOWY KSZTAŁT COMPACT SHAPE

ERGONOMICZNA RĘKOJEŚĆ ERGONOMIC HANDLE



0.9kW/1.22HP
25.4 cm³
12"/30.5 cm
3000-10500 min⁻¹
230 ml
0.325"

części zamienne spare parts / запчасти

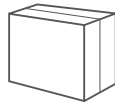

Ref.	L-W-H [mm]			EAN
58G950	300-255-250	5.0	0/2	5902062026071

1.8kW/2.45HP

Ref. 58G943

GAŹNIK WALBRO WALBRO CARBURETOR



PROWADNICA OREGON OREGON BAR
1.8kW/2.45HP
18"/45.8 cm
45 cm³
580 ml
2800-10000 min⁻¹
0.325"

części zamienne spare parts / запчасти

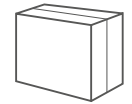

Ref.	L-W-H [mm]			EAN
58G943	460-275-305	7.3	0/2	5902062003157

10* YEARS SPARE PARTS AVAILABILITY

* Części zamienne dostępne na: gtxservice.pl
* Spare parts available on: gtxservice.pl
* Запасные части на: gtxservice.pl

@GRAPHITE

GRAPHITEmov

graphite.pl

Pilarka łańcuchowa spalinowa

Gasoline chain saw / Kettensäge m. Verbrennungsmotor / Пила цепная бензиновая / Пилка ланцюгова бензинова / Lánzfűrész benzinmotoros / Ferestrău cu lanț cu motor / Motorová řetězová pila benzinová / Benzinová reťazová píla / Bencinska verižna žaga / Grandininis benziniinis pjūklas / Benzina kēžu zāģis / Kettsaag (bensiniiga) / Верижен трион бензинов / Lančana benzinska pila / Benzinska lančana testera / Βενζινοκίνητο αλυσοπρίοιο / Motosierra / Moto sega / Electro-serra / Scie à bois à essence / Benzine kettingzaag

2kW (2.7KM)

Ref. 58G952

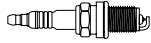

CDI IGNITION



ŁAŃCUCH OREGON
OREGON CHAIN

ERGONOMICZNA
REKOJEŚĆ
ERGONOMIC
HANDLE

2.0kW/2.7HP
52 cm³
3000-10500 min⁻¹

18"/45.8 cm
550 ml
0.325"

części zamienne
spare parts / запчасті

Ref.	L-W-H [mm]	kg	Box	EAN
58G952	455-265-280	7.2	0/2	5902062026088

Łańcuch do pilarki spalinowej

Chain for chain saw / Kettensägekette / Цепь для цепной пилы / Ланцюг до пилки ланцюгової / Lánzfűrészhez / Lanț p/u ferestrău cu lanț / Retěz řetězové pily / Reťaz do reťazovej pily / Veriga za verižno žago / Grandinė grandininiam pjūklui / Kēde kēžu zāģim / Kettsae kett / Kettsae kett / Верижен трион / Lanac za lančanu pilu / Lanac za elektricnu testera / Αλυσίδα / Cadena para sierra de cadena / Catena per motosega / Corrente para serra de motor / Chaîne pour scie à chaîne / Ketting voor kettingzaag

Ref. 58G950-71
Ref. 58G952-71
Ref. 58G941-71
Ref. 58G943-71
Ref. 89G940-71
Ref. 58G947-71



Ref	Image	Box	EAN
58G950-71	58G950	0/50	5902062032300
58G952-71	58G952	0/50	5902062032393
58G941-71	58G941	0/1	5902062469076
58G943-71	58G943	0/50	5902062003362
89G940-71	89G940	0/100	5902062032416
58G947-71	58G947	0/0	5902062222220

Prowadnica do pilarki spalinowej

Chain saw bar / Kettensägeführung / Направляющий стержень для цепной пилы / Стрижень направляющий до пилки ланцюгової / Lánfvezető / Ghidaj p/t ferestrău cu lanț / Vodicí lišta řetězové pily / Vodiaca lišta reťazovej pily / Vodilo verige za verižno žago / Kreipiančioji grandininiam pjūklui / Vadikla kēdes zāģim / Kettsae saetera / Шуна за верижен трион / Vodičica za lančanu pilu / Vodiča za lančanu testeru / Καθοδηγητικό για αλυσοπρίοιο / Bomba de sumersión para agua sucia / Barra di guida / Guías de motosega / Guidage pour scie à chaîne / Geleider voor benzine schuurmachine

Ref. 58G950-73
Ref. 58G952-73
Ref. 58G941-73
Ref. 58G943-73
Ref. 89G940-73



Ref	Image	L ["]	Box	EAN
58G950-73	58G950	12	0/20	5902062032317
89G940-73	58G952	16	0/20	5902062032423
58G952-73	58G941	18	0/20	5902062032409
58G941-73	58G943	12	0/1	5902062469083
58G943-73	89G940	18	0/30	5902062003379

Pompa zanurzeniowa do wody brudnej

Dirty water submersible pump / Wassertauchpumpe für Schmutzwasser / Насос погружной для грязной воды / Насос водний заглибний до стічних вод / Szivattyú szennyvízhez / Pompa de sufundat in apa murdara / Vodní ponorné čerpadlo na špinavou vodu / Ponorné čerpadlo na znečistenú vodu / Potorna vodna črpalka za umazano vodo / Panardinata vandens pompa užterštam vandeniu / Iegremdējamašis ūdenssūkņis netīrām ūdeņim / Sukelpump mudasele veele / Подводна помпа за мръсна вода / Срка за vodu - uranjajuća - za prljavu vodu / Pompa za vodu potopljena u prljavu vodu / Καταβύθιμη αντλία ακάθαρτων υδάτων / Pompa a immersione per acque sporche / Bomba de água de imersão / Pompe à eau immergée / Dompelaar pomp voor vuil water

650W

Ref. 59G446

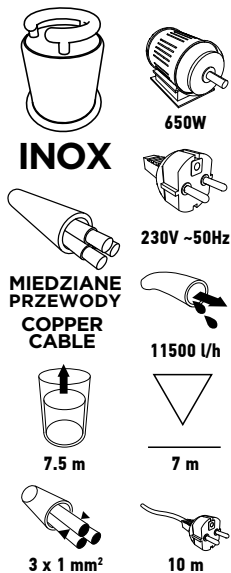

INOX
230V ~50Hz
MIEDZIANE PRZEWODY
COPPER
CABLE
11500 l/h
7.5 m
7 m
3 x 1 mm²
10 m



części zamienne
spare parts / запчасті

Ref.	L-W-H [mm]	kg	Box	EAN
59G446	225-225-370	5.7	0/4	5902062594464

900W

Ref. 59G449

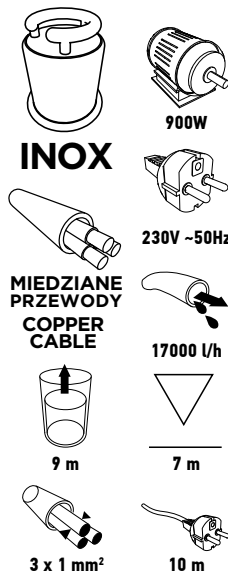

INOX
230V ~50Hz
MIEDZIANE PRZEWODY
COPPER
CABLE
17000 l/h
9 m
7 m
3 x 1 mm²
10 m



części zamienne
spare parts / запчасті

Ref.	L-W-H [mm]	kg	Box	EAN
59G449	230-230-390	7.0	0/2	5902062594495

GRAPHITE
POWER IN YOUR HANDS

3
YEARS
WARRANTY

3 lata gwarancji na WSZYSTKIE elektronarzędzia, urządzenia, akumulatory i ładowarki marki GRAPHITE. Regulamin dostępny na graphite.pl
3-year warranty on all power tools, devices, batteries and chargers. Terms and conditions are available on en.graphite.pl
Гарантия распространяется на весь электроинструмент GRAPHITE, включая батареи. Подробная информация доступна на сайте ru.graphite.pl

Kosiarka spalinowa

Gasoline lawn mower / Benzin Rasenmäher / Газонокосилка бензиновая / Benziňova gazonokosarka / Benzines fűnyíró / Mašina de tuns iarba pe benzină / Benziňová sekačka na trávu / Benziňová kosačka na trávu / Bensinska kosilnica / Benziňine vejarjove / Benzina zales plávejs / Bensiniņa turuņiņuk / Бензинова косачка за трева / Benziňska kosilica / Benziňska kosilica / Θεριστής βενζίνης / Cortacésped de gasolina / Rasaerba a benzina / Cortador de grama a gasolina / Tondeuse à gazon à essence / Benzine grasmaaier

1.3kW (1.8KM)

Ref. 52G670

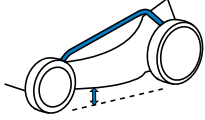

REGULOWANA
WYSOKOŚĆ
ADJUSTABLE
HEIGHT



KOSZ
BASKET

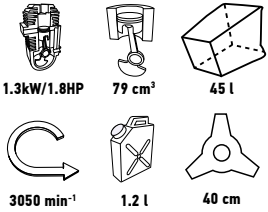

1.3kW/1.8HP
79 cm²
45 l
3050 min⁻¹
1.2 l
40 cm



części zamienne
spare parts / запчасті

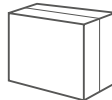

Ref.	L-W-H [mm]	Ⓢ [kg]	📦	EAN
52G670	725-505-440	19.5	0/1	5902062057389

3kW (4KM)

Ref. 52G672

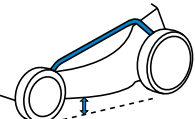

REGULOWANA
WYSOKOŚĆ
ADJUSTABLE
HEIGHT



NAPĘD
DRIVE



MULCZOWANIE
MULCHING

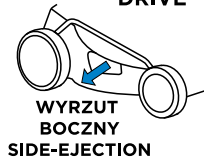

WYRZUT
BOCZNY
SIDE-EJECTION

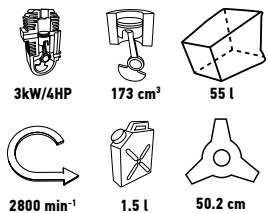

3kW/4HP
173 cm²
55 l
2800 min⁻¹
1.5 l
50.2 cm



części zamienne
spare parts / запчасті

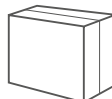

Ref.	L-W-H [mm]	Ⓢ [kg]	📦	EAN
52G672	820-570-500	36.0	0/1	5902062057402

2.2kW (3KM)

Ref. 52G671

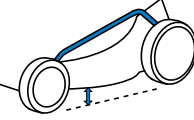

REGULOWANA
WYSOKOŚĆ
ADJUSTABLE
HEIGHT



NAPĘD
DRIVE



MULCZOWANIE
MULCHING

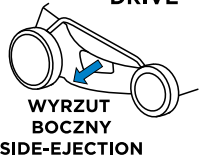

WYRZUT
BOCZNY
SIDE-EJECTION

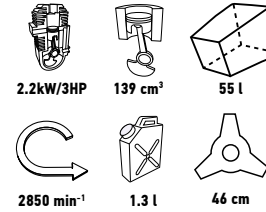

2.2kW/3HP
139 cm²
55 l
2850 min⁻¹
1.3 l
46 cm



części zamienne
spare parts / запчасті

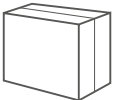

Ref.	L-W-H [mm]	Ⓢ [kg]	📦	EAN
52G671	570-785-475	31.0	0/1	5902062057396

3.2kW (4.35KM)

Ref. 52G673

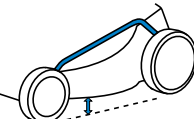

REGULOWANA
WYSOKOŚĆ
ADJUSTABLE
HEIGHT



NAPĘD
DRIVE



MULCZOWANIE
MULCHING



WYRZUT
BOCZNY
SIDE-EJECTION

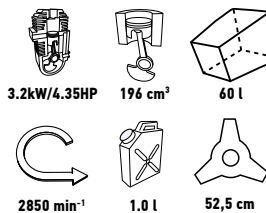

3.2kW/4.35HP
196 cm²
60 l
2850 min⁻¹
1.0 l
52,5 cm



części zamienne
spare parts / запчасті

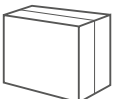

Ref.	L-W-H [mm]	Ⓢ [kg]	📦	EAN
52G673	570-920-500	36.5	0/1	5902062509444

10*
YEARS
SPARE PARTS
AVAILABILITY

* Części zamienne dostępne na: gtxservice.pl
* Spare parts available on: gtxservice.pl
* Запасные части на: gtxservice.pl

@GRAPHITE

GRAPHITEmov

graphite.pl

Nóż do kosiarki

Blade for lawn mower / Messer für Rasenmäher / Нож для газонокосилки / Ніж до газонокосарки / Penge fűnyíróhoz / Cuțit pentru cositoare / Nůž do sekačky / Nůž do kosačky / Rezilo za kosilnico / Peilis žoliapjovei / Plāvēja nazis / Trimmeri tera / Нож за косачка / Nož za kosilicu / Sečivo za kosilicu / Μαχαίρι για κλοοκοπική μηχανή / Cuchilla para cortacésped / Lama per tosaerba / Lámina para cortador de relva / Couteau pour tondeuse / Mesblad voor grasmaaiër

Ref. K113962
Ref. K114501
Ref. K114587
Ref. K114677



Ref			EAN
K113962	526670		5902062066251
K114501	526671		5902062067036
K114587	526672		5902062067555
K114677	526673		5902062068101

Głośnik Bluetooth z funkcją radia

Multimedia speaker / Multimedia-Lautsprecher / Мультимедийная колонка / Мультимедійний динамік / Multimedia hangszóró / Difuzor multimedia / Multimediální reproduktor / Multimediálny reproduktor / Multimedijski zvočnik / Multimedijos garsiakalbis / Multimediju skaļrunis / Multimedijumkõlar / Мультимедийен високоговорител / Multimediální zvučnik / Multimedijski zvočnik / Hχείο πολυμέσων / Altavoz multimedia / Altoparlante multimediale / Altifalante multimédia / Haut-parleur multimédia

2x 5W

Ref. 57G100



4500 mAh



BT
FM
SD
AUX
USB
MP3
IP65

Ref.	L-W-H [mm]	[kg]		EAN
57G100	180-56-90	0.6	0/20	5902062045911

Termos

Vacuum flask / Isolierflasche / Термос / Термос / Termosz / Termos / Termoska / Termoska / Termovka / Termosas / Termoss / Termos / Термос / Termos boca / Termos / Θερμός / Termo / Borraccia termica / Garrafa térmica / Thermos / Thermosflæs

500 ml

Ref. GD05

STAINLESS
STEEL



Ref.	L-W-H [mm]	[kg]		EAN
GD05	70-240-70	0.3	0/50	5902062025029

800 ml

Ref. GD04

STAINLESS
STEEL



Ref.	L-W-H [mm]	[kg]		EAN
GD04	95-325-95	0.5	0/30	5902062025012



GRAPHITE
POWER IN YOUR HANDS

3
YEARS
WARRANTY

3 lata gwarancji na WSZYSTKIE elektronarzędzia, urządzenia, akumulatory i ładowarki marki GRAPHITE. Regulamin dostępny na graphite.pl
3-year warranty on all power tools, devices, batteries and chargers. Terms and conditions are available on en.graphite.pl
Гарантия распространяется на весь инструмент GRAPHITE, включая батареи. Подробная информация доступна на сайте ru.graphite.pl

Spawarka inwertorowa IGBT

Inverter / Inverter-Schweißgerät / Инвертированный сварочный аппарат / Інвертор зварювальний / Hegesztő inverter / Mašina de sudat invertică / Invertorová svářečka / Zvárací inverter / Inverterski varilnik / Invertinis suvirinimo aparatas / Invertētais metināšanas aparāts / Inverter-keevitusaparaat / Инвертерен заварьчен автоматом / Invertni aparat za zavarivanje / Invertni zavarivač / Μηχάνημα συγκόλλησης με εναλλασσόμενο ρεύμα / Soldadora inverter / Saldatrice a inverter / Máquina de soldagem de inversão / Poste de soudure inverter / Inverter lasapparaat

120A

Ref. 56H811

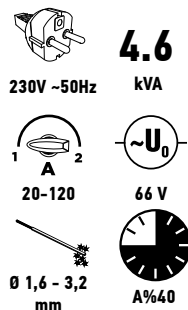

IP21S

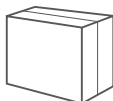

Ref.	L-W-H [mm]	⊞ [kg]	⊞	EAN
56H811	310-216-182	3.0	0/0	5902062046208

160A

Ref. 56H812

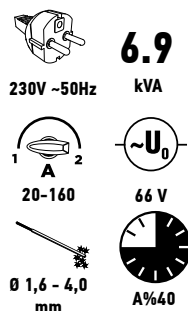

IP21S

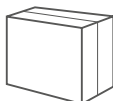

Ref.	L-W-H [mm]	⊞ [kg]	⊞	EAN
56H812	310-216-182	3.2	0/0	5902062046215

200A

Ref. 56H813

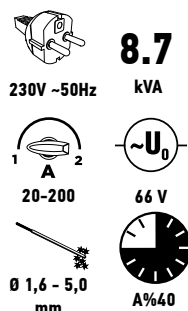

IP21S

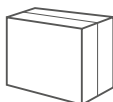

Ref.	L-W-H [mm]	⊞ [kg]	⊞	EAN
56H813	310-216-182	3.2	0/0	5902062046222

Przyłbica spawalnicza

Welder's helmet / Schweißerschutzhelm / Шлем сварочный / Каска зварювальника / Hegesztősisak automatikus / Cască de sudor / Svářečská maska / Zváracská helma / Čelada za varilca / Suvirintojo šalmas / Metinātāja maska / Keevituskiiver / Maska za elektrokožen / Maska za varioce / Maska za varioce / Κράνιο οξυγονοκολλητή / Máscara de soldadura con visera / Visiera per saldatura / Capacete de soldador / Casque de soudeur / Lashelm

Ref. 56H820



**DIN11
MMA
MIG
MAG/CO²
TIG
PLASMA
EN379**

Ref.	L-W-H [mm]	⊞ [kg]	⊞	EAN
56H820	330-230-235	0.8	0/1	5902062006974

Ref. 56H822



**DIN9-13
MMA
MIG
MAG/CO²
TIG
PLASMA
EN379**

Ref.	L-W-H [mm]	⊞ [kg]	⊞	EAN
56H822	330-230-235	0.8	0/1	5902062006981

Ostona przeciwoodpryskowa

Protection shield / Splitterschutz / Щиток противосколочный / Щиток протиосколочний / Arcvedó / Ecran protecție / Clona proti odpryskům / Ochranný štít / Ščitnik za obraz / Apsauginis skydelis veidui / Pretlauskų aizsargmaska / Kaitsevisiir / Предназначен щитум / Štitnik za lice / Štitnik za lice / Μάσκα κεφαλής προστασίας από θραύσματα / Mascara protectora facial / Schermo di sostituzione per casco autoscurante / Protecáo / Protecteur anti-eclats / Bescherming tegen slingerende deeltjes

Ref. 56H824

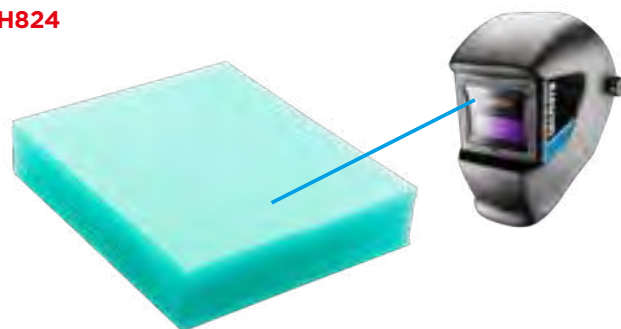

x20

Ref.	L-W-H [mm]	⊞ [kg]	⊞	EAN
56H824	108 x 90 x 1 x 20	0.026	20/280	5902062022325

10*
YEARS
SPARE PARTS
AVAILABILITY

* Części zamienne dostępne na: gtxservice.pl
* Spare parts available on: gtxservice.pl
* Запасные части на: gtxservice.pl

@GRAPHITE

GRAPHITEmov

graphite.pl

Elektrody rutyłowe

Rutile electrodes / Rutil-Elektroden / Рутыловые электроды / Електроди рутылови / Elektroda / Electrozi de rutil / Rutilové elektrody / Rutilové elektródy / Rutiline elektrode / Elektrodi su rutilo glaistu / Rutila elektrod / Rutilelektrodid / Рутылову електроду / Elektrode za zavarivanje / Rutil elektrode / Ηλεκτρόδια ρουτίλιου / Electrodo de rutilo / Elettrodi rutilici / Eléktrodos especiais / Baguettes rutilés / Rutiel elektroden



Ref.	Ø [mm]	L [mm]	m [kg]		EAN
56H825	2.5	350	5	0/1	5902062007049
56H827	3.25	350	5	0/1	5902062007056
56H829	4.0	400	5	0/1	5902062007063
56H833	1.8	350	1	0/1	5902062050373
56H839	2.0	350	1	0/1	5902062007001
56H830	2.5	350	1	0/1	5902062007018
56H835	3.25	350	1	0/1	5902062007025
56H840	4.0	400	1	0/1	5902062007032

Uchwyt spawalniczy

Electrode holder / Schweißklemme / Электрододержатель / Затискач электросвариваемый / Elektroda fogó / Dispozitiv fixare electrod / Držák svářečských elektrod / Držiak elektródy / Držalo za elektrodo / Rankena elektrodams / Elektrodu turētājs / Elektroodihoidik / Ръкохватка за електрожен / Držač elektrode / Dryac elektrode / Λαβή οξυγονοκόλλησης / Portaelectrodo para soldadura / Pinza per elettrodo / Suporte p. soldagem / Manche de soudure / Lashouder



Ref.	Ø [mm ²]	A	Ø [mm]	m [kg]		EAN
56H870	25 - 35	160 @ (P60%)	1.6 - 4	0.3	0/20	5902062007148
56H871	35 - 50	200 @ (P60%)	2 - 5	0.3	0/20	5902062007155
56H872	50 - 70	315 @ (P60%)	2.5 - 6.3	0.4	0/20	5902062007162

Regulowany wspornik magnetyczny

Magnetic welding angle / Magnetwinkel für Schweißarbeiten / Магнитный уголок для сварочных работ / Косионец для зварювальних робіт магнітний / Hegesztőmágnes állítható / Cornier magnetic p/t sudori / Magnetický úhelník pro svařování / Magnetický zvaráci uholník / Magnetni kotnik za varjenje / Magnetinis suvirinimo kampas / Magnētiskais metināšanas stūrenis / Magnetnurkraud keevitustöödeks / Бѐлов профил магнитен заваряващ / Magnetski kutnik za zavarivanje / Magnetni uglomer za varenje / Μαγνητική γωνία συγκόλλησης / Escuadra magnética para soldadura / Squadra magnetica per saldatura / Cantoneira magnética para soldar / Equerre magnétique de soudeur / Magnetisch laswinkelhaak



Ref.	udźwig / capacity / мощность [kg]		EAN
56H900	22.7	1.6	0/1 5902062007261

Drut spawalniczy

Welding wire / Schweißdraht / Проволока сварочная / Дрпм зварювальний / Hegesztő huzal / Sárná de sudat / Drát pro svařování / Sprájkovací drôt / Varilla žica / Litavimo viela / Metināšanas stieple / Keevitustraat / Тел за зваряване / Žica za zavarivanje / Žice za zavarivanje / Σύρμα συγκόλλησης / Varilla de soldar / Filo per saldare / Arame de solda / Fil de soudure / Lasdraad



Ref.	Ø [mm]	m [kg]		EAN
56H847	0.8 mm	5	0/1	5902062007087
56H849	1.0 mm	5	0/1	5902062007094

Zacisk biegunowy, kleszczowy

Earth clamp - pincers / Polzangenklemme / Клемма заземления „крокодил” / Затискач полюсний клемний / Test csipesz / Clemă de legare la pământ - clește / Svorka pólová klešťová / Svorka zvaračská / Sponka / Žnyplés - spaustuvas / Klemme / Maaklemm - năpitsad / Щипка за маса / Kliješta za masu-pinceta / Spona / Σφιγκτήρας γείωσης - πένσες / Pinzas de apriete / Morsetto polare a pinza / Abraçadeira polar / Borne polaire - à mors / Poolklemmen



Ref.	Ø [mm ²]	A	m [kg]		EAN
56H880	35	160 @ (P60%)	0.2	0/50	5902062007193
56H881	70	315 @ (P60%)	0.25	0/50	5902062007209
56H882	90	520 @ (P60%)	0.3	0/50	5902062007216

Spawalniczy kątownik magnetyczny

Magnetic welding angle / Magnetwinkel für Schweißarbeiten / Магнитный уголок для сварочных работ / Косионец для зварювальних робіт магнітний / Hegesztőmágnes / Cornier magnetic p/t sudori / Magnetický úhelník pro svařování / Magnetický zvaráci uholník / Magnetni kotnik za varjenje / Magnetinis suvirinimo kampas / Magnētiskais metināšanas stūrenis / Magnetnurkraud keevitustöödeks / Бѐлов профил магнитен заваряващ / Magnetski kutnik za zavarivanje / Magnetni uglomer za varenje / Μαγνητική γωνία συγκόλλησης / Escuadra magnética para soldadura / Squadra magnetica per saldatura / Cantoneira magnética para soldar / Equerre magnétique de soudeur / Magnetisch laswinkelhaak



Ref.	kąty / angles / углы	udźwig / capacity / мощность [kg]	L x H x W [mm]		EAN
56H901	45° / 90°	11.4	180 x 112 x 15	0/1	5902062007278
56H902	45° / 90°	22.7	230 x 145 x 20	0/1	5902062007285
56H903	45° / 90°	34.0	237 x 169 x 30	0/1	5902062007292
56H904	45° / 60° / 75° / 90° / 135°	11.4	175 x 110 x 16	0/1	5902062007308
56H905	45° / 60° / 75° / 90° / 135°	34.0	240 x 170 x 28	0/1	5902062007315

Wiertła do metalu

HSS drills / Metallbohrer / Сверла по металлу / Сверла по металлу / Csígfúró / Burghie pentru metale / Vrtáky do kovu / Vrtáky do k Wiertła diamentowe oву / Svedri za kovino / Grążtאי metalui / Urbis metālam / Metallpuur / Сврла за метал / Svrđla za metal / Burgija za metal / Τρυπάνια μετάλλου / Brocas para metal / Punta per metallo / Brocas p. metal / Forêts à métal / Boren voor metaal

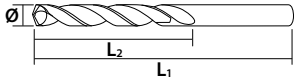

HSS Co5%

DIN338



Ref.	ø [mm]	L1 [mm]	L2 [mm]	📦	📦	EAN	Ref.	ø [mm]	L1 [mm]	L2 [mm]	📦	📦	EAN	Ref.	ø [mm]	L1 [mm]	L2 [mm]	📦	📦	EAN
57H010	1.0	34	12	5	20/200	5902062570109	57H042	7.0	109	69	1	20/200	5902062570420	57H024-10	4.0	75	43	10	20/200	5902062221995
57H012	1.5	40	18	5	20/200	5902062570123	57H044	7.5	109	69	1	20/200	5902062570444	57H026-10	4.2	75	43	10	20/200	5902062222008
57H014	2.0	49	24	5	20/200	5902062570147	57H046	8.0	117	75	1	20/200	5902062570468	57H028-10	4.5	80	47	10	20/200	5902062222015
57H015	2.2	53	27	3	20/200	5902062570154	57H048	8.5	117	75	1	20/200	5902062570482	57H030-10	4.8	86	52	10	10/100	5902062222022
57H016	2.4	57	30	3	20/200	5902062570161	57H050	9.0	125	81	1	20/200	5902062570505	57H032-10	5.0	86	52	10	10/100	5902062222039
57H018	2.5	57	30	3	20/200	5902062570185	57H052	9.5	125	81	1	20/200	5902062570529	57H034-10	5.2	86	52	10	10/100	5902062222046
57H020	3.0	61	33	1	20/200	5902062570208	57H054	10.0	133	87	1	20/200	5902062570543	57H036-10	5.5	93	57	10	10/100	5902062222053
57H022	3.2	65	36	1	20/200	5902062570222	57H055	10.2	133	87	1	20/200	5902062570550	57H038-10	6.0	93	57	10	10/100	5902062222060
57H023	3.5	70	39	1	20/200	5902062570239	57H056	10.5	133	87	1	20/200	5902062570567	57H040-10	6.5	101	63	10	5/50	5902062222077
57H024	4.0	75	43	1	20/200	5902062570246	57H058	11.0	142	94	1	20/200	5902062570581	57H042-10	7.0	109	69	10	5/50	5902062222084
57H026	4.2	75	43	1	20/200	5902062570260	57H062	12.0	151	101	1	20/200	5902062570628	57H046-5	8.0	117	75	5	10/60	5902062222107
57H028	4.5	80	47	1	20/200	5902062570284	57H064	12.5	151	101	1	20/120	5902062570642	57H048-5	8.5	117	75	5	10/60	5902062222114
57H030	4.8	86	52	1	20/200	5902062570307	57H066	13.0	151	101	1	20/120	5902062570666	57H050-5	9.0	125	81	5	10/60	5902062222121
57H032	5.0	86	52	1	20/200	5902062570321	57H014-10	2.0	49	24	10	20/600	5902062221933	57H054-5	10.0	133	87	5	10/60	5902062222145
57H034	5.2	86	52	1	20/200	5902062570345	57H018-10	2.5	57	30	10	20/400	5902062221957	57H056-5	10.5	133	87	5	10/60	5902062222152
57H036	5.5	93	57	1	20/200	5902062570369	57H020-10	3.0	61	33	10	20/400	5902062221964	57H058-5	11.0	142	94	5	10/40	5902062222169
57H038	6.0	93	57	1	20/200	5902062570383	57H022-10	3.2	65	36	10	20/200	5902062221971	57H062-5	12.0	151	101	5	10/40	5902062222183
57H040	6.5	101	63	1	20/200	5902062570406	57H023-10	3.5	70	39	10	20/200	5902062221988	57H066-5	13.0	151	101	5	10/40	5902062222206

Tabela prędkości wiercenia

ø [mm]	STAL/STAL [min ⁻¹]	INOX [min ⁻¹]
1.0-2.0	4770	1000
2.1-2.5	3800-4500	800-1000
2.6-3.0	3200-3650	600-800
3.1-3.5	2700-3100	600-800
3.6-4.0	2400-2650	500-600
4.1-4.5	2000-2200	400-500
4.6-5.0	1800-1950	300-400
5.1-6.0	1600-1750	300-400
6.1-8.0	1100-1450	250-300
8.1-10.0	1000-1100	200-300
10.1-12.0	750-900	150-200
12.1-14.0	650-750	120-150



DIN338

HSS Co5%

DIN338

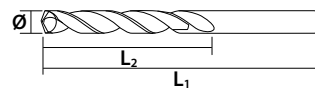

HSS TiN



Ref.	ø [mm]	L1 [mm]	L2 [mm]	📦	📦	EAN
57H110	1.0	34	12	5	20/200	5902062571106
57H112	1.5	40	18	5	20/200	5902062571120
57H114	2.0	49	24	5	20/200	5902062571144
57H116	2.4	57	30	3	20/200	5902062571168
57H118	2.5	57	30	3	20/200	5902062571182
57H120	3.0	61	33	1	20/200	5902062571205
57H122	3.2	65	36	1	20/200	5902062571229
57H123	3.5	70	39	1	20/200	5902062571236
57H124	4.0	75	43	1	20/200	5902062571243
57H126	4.2	75	43	1	20/200	5902062571267
57H128	4.5	80	47	1	20/200	5902062571281
57H130	4.8	86	52	1	20/200	5902062571304
57H132	5.0	86	52	1	20/200	5902062571328
57H134	5.2	86	52	1	20/200	5902062571342
57H136	5.5	93	57	1	20/200	5902062571366
57H138	6.0	93	57	1	20/200	5902062571380
57H140	6.5	101	63	1	20/200	5902062571403
57H142	7.0	109	69	1	20/200	5902062571427
57H144	7.5	109	69	1	20/200	5902062571441
57H146	8.0	117	75	1	20/200	5902062571465
57H148	8.5	117	75	1	20/200	5902062571489
57H150	9.0	125	81	1	20/200	5902062571502
57H152	9.5	125	81	1	20/200	5902062571526
57H154	10.0	133	87	1	20/200	5902062571540
57H156	10.5	133	87	1	20/200	5902062571564
57H158	11.0	142	94	1	20/200	5902062571588
57H162	12.0	151	101	1	20/200	5902062571625
57H164	12.5	151	101	1	20/120	5902062571649
57H166	13.0	151	101	1	20/120	5902062571663

Ref.	ø [mm]	📦	📦	EAN
57H086	4, 5, 6, 8, 10	5	25/100	5902062025364
57H088	1.5, 2, 2.5, 3, 3.2, 3.5, 4, 4.2, 4.8, 5, 5.5, 6, 6.5	13	50/100	5902062570888
57H089	1, 1.5, 2, 2.5, 3, 3.5, 4, 4.5, 5, 5.5, 6, 6.5, 7, 7.5, 8, 8.5, 9, 9.5, 10	19	10/40	5902062570895
57H090	1, 1.5, 2, 2.5, 3, 3.5, 4, 4.5, 5, 5.5, 6, 6.5, 7, 7.5, 8, 8.5, 9, 9.5, 10, 10.5, 11, 11.5, 12, 12.5, 13	25	0/10	5902062570901

POWER IN YOUR HANDS

Wiertła do metalu

HSS drills / Metallbohrer / Сверла по металлу / Сверла по металу / Csigafúró / Burghie pentru metale / Vrtáky do kovu / Vrtáky do kovu / Svedri za kovino / Grąztai metalui / Urbis metālam / Metallijuur / Сврла за метал / Svrdla za metal / Burgija za metal / Τρυπάνια μετάλλου / Brocas para metal / Punta per metallo / Brocas p. metal / Forêts à métal / Boren voor metaal

DIN338

HSS



METAL

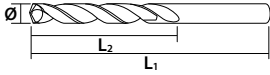

Ref.	Ø [mm]	L1 [mm]	L2 [mm]		EAN
55H010	2.0	46	24	125/500	5902062997074
55H013	2.5	57	30	125/500	5902062997104
55H014	3.0	61	33	125/500	5902062997111
55H015	3.2	65	36	125/500	5902062997128
55H016	3.5	70	39	125/500	5902062997135
55H017	3.8	75	43	125/500	5902062997142
55H018	4.0	75	43	125/500	5902062997159
55H019	4.2	75	43	120/480	5902062997166
55H020	4.5	80	47	120/480	5902062997173
55H021	4.8	86	52	120/480	5902062997180
55H022	5.0	86	52	120/480	5902062997197
55H024	5.5	93	57	120/480	5902062997210
55H025	6.0	93	57	120/480	5902062997227
55H026	6.5	101	63	120/480	5902062997234
55H027	7.0	101	63	75/300	5902062997241
55H029	8.0	117	75	75/300	5902062997265
55H030	8.5	117	75	75/300	5902062997272
55H031	9.0	125	81	75/300	5902062997289
55H033	10.0	133	87	50/200	5902062997302
55H034	10.2	133	87	50/200	5902062997319
55H035	10.5	133	87	50/200	5902062997326
55H036	11.0	142	94	50/200	5902062997333
55H038	12.0	151	101	50/200	5902062997357
55H039	12.5	151	101	45/180	5902062997364
55H040	13.0	151	10	45/180	5902062997371



HSS



METAL

DIN338



Ref.	Ø [mm]			EAN
55H086	4, 5, 6, 8, 10	5	25/100	5902062025388
55H088	1, 5, 2, 2.5, 3, 3.2, 3.5, 4, 4.2, 4.8, 5, 5.5, 6, 6.5	13	25/100	5902062025395
55H089	1, 1.5, 2, 2.5, 3, 3.5, 4, 4.5, 5, 5.5, 6, 6.5, 7, 7.5, 8, 8.5, 9, 9.5, 10	19	10/40	5902062025401
55H090	1, 1.5, 2, 2.5, 3, 3.5, 4, 4.5, 5, 5.5, 6, 6.5, 7, 7.5, 8, 8.5, 9, 9.5, 10, 10.5, 11, 11.5, 12, 12.5, 13	25	5/20	5902062025418



SZLIFOWANA SPIRALA
GRINDED FLUTE



135°



METAL

DIN338

HSS
TiN



Ref.	Ø [mm]			EAN
57H196	4, 5, 6, 8, 10	5	25/100	5902062025371
57H198	1, 5, 2, 2.5, 3, 3.2, 3.5, 4, 4.2, 4.8, 5, 5.5, 6, 6.5	13	50/100	5902062571984
57H199	1, 1.5, 2, 2.5, 3, 3.5, 4, 4.5, 5, 5.5, 6, 6.5, 7, 7.5, 8, 8.5, 9, 9.5, 10	19	10/40	5902062571991
57H200	1, 1.5, 2, 2.5, 3, 3.5, 4, 4.5, 5, 5.5, 6, 6.5, 7, 7.5, 8, 8.5, 9, 9.5, 10, 10.5, 11, 11.5, 12, 12.5, 13	25	0/10	5902062572004

GRAPHITE

Wiertło bezstopniowe

Stepless Conical Bit / Stufenloser Bohrer / Сверло коническое / Свердло коничне / Fokozatmentes fűró / Burghiu nelărgitor / Kuželový vrták / Kuželový vrták / Stožčasti sveder / Konusinis grąžtas / Koniskais urbis / Koonuspuur / Конично сярэдня / Konusno svrdlo / Glatka burgija / Τρυπάνι με κωνικό στέλεχος / Broca sin grados / Punta conica / Broca sem graus / Foret non étagé / Traploze boor



Ref.	ø [mm]		EAN
57H741	4-32	10/50	5902062577412

Wiertło stopniowe

Stepped Conical Bit / Stufenbohrer / Сверло ступенчатое / Свердло ступенчeve / Lépcsős fűrószár / Burghiu lărgitor conic / Stupňovitý vrták / Stupňovitý vrták / Stopenjski sveder / Pakopinis grąžtas / Pakārpņveida urbis / Astmeline puur / Многостъпнално сярэдня / Stepenasta svrdlo / Konusna - stepenasta burgija / Τρυπάνι διάνοιξης οπών με διαβάθμιση / Broca con grados / Punta conica / Broca de graus / Foret étagé / Trapboor



Ref.	ø [mm]		EAN
57H739	4-22	50/100	5902062577399
57H740	4-32	10/50	5902062577405

Wiertła do betonu

Concrete drills / Betonbohrer / Сверла по бетону / Свердла по бетону / Betonfűró / Burghie pentru beton / Vrtáky do betonu / Vrtáky do betónu / Svedri za beton / Grąžtai betonui / Betona urbji / Betonpuur / Сярэдня за бетон / Svrdlo za beton / Burgije za beton / Τρυπάνια μπετού / Brocas para hormigón / Punta da muro / Brocas p. Betão / Forêts pour béton / Boren voor beton

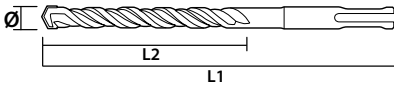

Ref.	ø [mm]	L1 [mm]	L2 [mm]		EAN	Ref.	ø [mm]	L1 [mm]	L2 [mm]		EAN	Ref.	ø [mm]	L1 [mm]	L2 [mm]		EAN
57H400	4	110	50	50/300	5902062574008	57H430	10	350	290	25/150	5902062574305	57H464	14	450	390	15/60	5902062574640
57H404	5	160	100	50/200	5902062574046	57H432	10	400	340	25/100	5902062574329	57H466	14	600	540	0/60	5902062574664
57H406	6	110	50	50/300	5902062574060	57H434	10	600	540	0/100	5902062574343	57H470	16	210	150	25/100	5902062574701
57H408	6	160	100	50/200	5902062574084	57H438	12	160	100	50/200	5902062574381	57H472	16	260	200	25/100	5902062574725
57H410	6	210	150	50/200	5902062574107	57H440	12	210	150	50/200	5902062574404	57H474	16	310	250	20/80	5902062574749
57H412	6	260	200	50/200	5902062574121	57H442	12	260	200	40/160	5902062574428	57H476	16	400	340	15/60	5902062574763
57H414	7	260	200	50/200	5902062996879	57H444	12	310	250	25/150	5902062574442	57H478	16	600	540	0/45	5902062574787
57H416	8	110	50	10/200	5902062574145	57H446	12	400	340	25/100	5902062574466	57H480	18	260	200	1/80	5902062574800
57H418	8	160	100	50/200	5902062574169	57H448	12	450	390	25/100	5902062574480	57H482	18	310	250	0/50	5902062574824
57H420	8	210	150	50/200	5902062574183	57H450	12	600	540	0/60	5902062574503	57H484	18	400	340	15/60	5902062574848
57H422	9	260	200	50/200	5902062996886	57H454	14	210	150	25/150	5902062574541	57H486	18	600	540	0/40	5902062574862
57H424	8	260	200	50/200	5902062574206	57H456	14	260	200	25/100	5902062574565	57H488	20	600	540	0/25	5902062574886
57H426	10	160	100	50/100	5902062574244	57H458	14	310	250	1/100	5902062574589	57H490	20	800	740	0/20	5902062574909
57H428	10	210	150	0/200	5902062574268	57H460	14	350	290	25/100	5902062574602	57H492	24	600	540	0/20	5902062574923
57H428	10	260	200	50/200	5902062574282	57H462	14	400	340	20/80	5902062574626	57H494	24	800	740	0/12	5902062574947

Ref.	Ø [mm]	L1 [mm]	L2 [mm]		EAN	
57H576	6	110	50	10	20/40	5902062027467
57H577	6	160	100	10	20/40	5902062027474
57H578	8	160	100	10	20/20	5902062027481

Ref.	Ø [mm]	L1 [mm]	L2 [mm]		EAN
57H312	4	75	40	125/500	5902062573124
57H313	5	80	50	50/500	5902062573131
57H314	6	100	60	50/400	5902062573148
57H316	8	120	80	50/500	5902062573162
57H318	10	120	80	50/500	5902062573186
57H320	12	150	85	50/200	5902062573209
57H322	14	150	85	40/200	5902062573223
57H328	20	160	100	20/80	5902062573285
57H330	6	150	135	50/300	5902062573308
57H332	8	250	135	25/150	5902062573322
57H334	10	250	135	25/150	5902062573346
57H336	12	250	135	30/150	5902062573360
57H338	14	250	135	25/100	5902062573384
57H342	10	400	230	25/50	5902062573421
57H344	10	600	400	0/60	5902062573445
57H346	12	600	400	0/60	5902062573469

POWER IN YOUR HANDS

Wiertła do betonu

Concrete drills / Betonbohrer / Свёрла по бетону / Свёрла по бетону / Betonfúró / Burghie pentru beton / Vrtáky do betonu / Vrtáky do betónu / Svedri za beton / Gržtai betonui / Betona urbji / Betoonipuur / Свёрла за бетон / Svrdlo za beton / Burgije za beton / Τρυπάνια µπετού / Brocas para hormigón / Punta da muro / Brocas p. Betão / Forêts pour béton / Boren voor beton

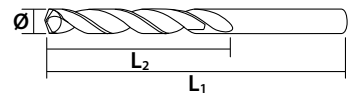

x5



Ref.	Ø [mm]	L1 [mm]	L2 [mm]			EAN
57H350	4	75	40	5	25/100	5902062573506
	5	100	50			
	6	100	60			
	8	120	80			
	10	120	80			

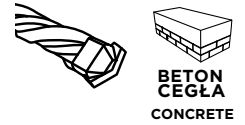
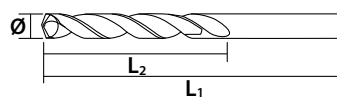

x4



Ref.	Ø [mm]	L1 [mm]	L2 [mm]			EAN
57H746	4	75	40	4	30/120	5902062577467
	6	100	50			
	8	120	60			
	10	120	80			



Ref.	Ø [mm]		EAN
57H351	4, 5, 5, 6, 6, 7, 8, 10	25/100	5902062027436



for SDS^{plus}



Ref.	Ø [mm]		EAN
57H572	5, 6, 8, 10, 12	25/50	5902062027450

for SDS^{MAX}

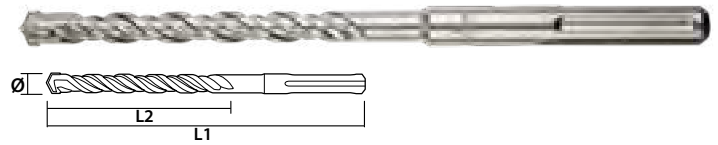

Ref.	Ø [mm]	L1 [mm]	L2 [mm]		EAN
57H506	16	310	170	0/60	5902062575067
57H508	16	400	260	0/37	5902062575081
57H510	16	600	460	0/30	5902062575104
57H514	18	310	170	0/50	5902062575142
57H516	18	400	260	0/60	5902062575166
57H518	18	600	460	0/30	5902062575180
57H520	20	600	460	5/20	5902062575203
57H524	24	600	460	0/20	5902062575241
57H526	24	800	660	0/12	5902062575265
57H528	24	1000	860	0/10	5902062575289
57H530	24	1200	1060	0/7	5902062575302
57H532	28	600	460	0/12	5902062575326
57H534	28	800	660	0/10	5902062575340
57H540	32	600	460	0/10	5902062575401
57H542	32	800	660	0/10	5902062575425
57H544	32	1000	860	0/6	5902062575449
57H546	32	1200	1060	0/6	5902062575463

for SDS^{plus}



Ref.	Ø [mm]	L [mm]		EAN
57H570	6, 8, 10	110	50/100	5902062027443

Wiertła diamentowe

Diamond drill / Diamantbohrer / Сверло алмазное / Сверло диамантове / Gyémántfűrő / Burghiu diamantat / Diamantový vrták / Diamantový vrták / Diamantno steklo / Deimantinis grąžtas / Dimanta urbis / Teemantpuur / Диамантено сѣредло / Dijamantno svrdlo / Dijamntska burgija / Διαμαντορύπανο / Broca de diamante / Sega a tazza diamentata / Broca de diamante / Foret diamanté / Diamantboor

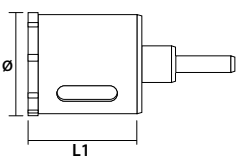

Ref.	Ø [mm]	L [mm]		EAN
57H278	6	30	36/360	5902062572783
57H279	8	30	36/360	5902062572790
57H280	10	30	36/360	5902062572806
57H284	12	30	36/360	5902062572844
57H285	18	30	20/240	5902062572851
57H286	22	30	24/240	5902062572868
57H287	25	30	12/120	5902062572875
57H288	32	30	8/80	5902062572882
57H289	35	30	8/80	5902062572899
57H290	38	30	8/80	5902062572905
57H291	40	30	10/80	5902062572912
57H292	44	30	10/50	5902062572929
57H293	50	30	4/40	5902062572936
57H294	53	30	10/40	5902062572943
57H295	60	30	4/40	5902062572950
57H296	65	30	4/40	5902062572967
57H297	67	30	4/40	5902062572974
57H298	73	30	4/40	5902062572981
57H299	83	30	6/24	5902062572998
57H300	100	30	8/40	5902062573001



Otwornica diamentowa

Diamond hole cutter / Diamantbohrkrone / Алмазная коронка / Алмазная коронка / Gyémánt lyukvágó / Coroana diamantata / Diamantová korunka / Diamantová korunka / Diamantna krona / Deimantinis grąžtas / Dimanta krūpurbis / Teemantaugusaag / Диамантена корона / Kruna za rupe dijamantska / Бушилица од камена / Κόφτης διαμαντιών / Diamante agujero cortadore / Fresa diamentata / Cortador de buraco de diamante / Fraise diamentée / Diamant Gatenfrees

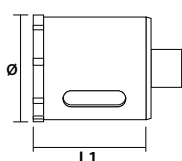
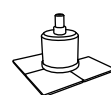

Ref.	Ø [mm]	L [mm]		EAN
55H300	6	40	10/100	5902062509222
55H301	8	40	10/100	5902062509239
55H302	10	40	10/100	5902062509246
55H303	12	40	10/100	5902062509253
55H304	16	40	10/100	5902062509260
55H305	20	40	10/100	5902062509277
55H306	22	40	10/100	5902062509284
55H307	25	40	10/100	5902062509291
55H308	28	40	10/100	5902062509307
55H309	32	40	5/100	5902062509314
55H310	35	40	5/100	5902062509321
55H311	40	40	5/100	5902062509338
55H312	45	40	5/50	5902062509352
55H313	55	40	5/50	5902062509376
55H314	65	40	5/50	5902062509390
55H315	68	40	5/50	5902062509406
55H316	72	40	5/40	5902062509413
55H317	83	40	5/20	5902062509420

Wycinarka otworów w glazurze

Adjustable hole cutter / Fliesenstichsäge / Сверло для плитки / Викружальник регульованій / Csempékörkivágó állítható / Mecanism de reglare perforare găuri / Fréza na díry v glazuře / Vykružováč na obkladačky / Urezovalec lukenj v ploščice / Prietaisais ertmiu pjoivimui plytelése / Саурумзājis / Tellitan augulōikur / Бургия за фаянс / Pedešavajući sječač / Sekač za rupe / Ρυθμιζόμενη πέννα πλακά / Sacabocado para azulejos / Sega a tazza regolabile / Serra de contorno para azulejos / Découpeuse d'ouvertures dans le carrelage / Gatenknipper voor glazuur

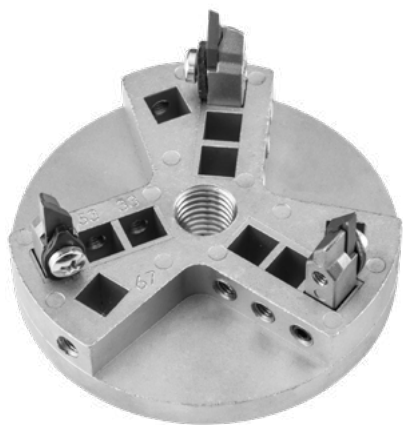
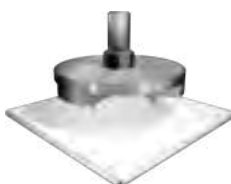

Ref.	Ø [mm]		EAN
55H540	33, 53, 67, 73	0/10	5902062685407

Adapter

Adapter / Adapter / Адаптер / Перехідник / Közdarab, adapter / Adaptor / Adaptér / Adaptér / Adapter / Jungtis / Adapteris / Adapter / Адаптер / Adapter / Adapter / Αντάπτορας / Adattatore / Adaptador / Adaptateur / Adapter

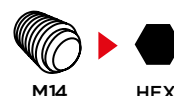

Ref.		EAN
55H320	10/100	5902062509437

Wiertła do szkła

Glass drill / Glasbohrer / Сверло по стеклу / Сверло по склу / Üvegfűrő / Burghiu pentru sticlă / Vrták do skla / Vrták do skla / Sveder za steklo / Grąžtai stikliui / Urbis stiklam / Klasijpuur / Сѣредло за стъкло / Svrdlo za staklo / Burgija za staklo / Τρυπάνια γυαλιού / Broca para vidrio / Punta per vetro / Broca p. Vidro / Foret à verre / Boor voor glas

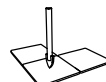
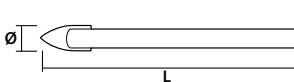

Ref.	Ø [mm]	L [mm]		EAN
57H260	5	70	10/50	5902062572608
57H261	6	75	10/50	5902062572615
57H262	8	80	10/50	5902062572622
57H263	10	85	10/50	5902062572639

Szpicak

Point chisel / Spitzeisen / Долово-нука / Пробивач / Hegyveséső / Daltă / Špičák / Sekáč špicatý / Koničasti sekač / Pincetas / Kalts spicais / Terava otsaga peitel / Шуно / Špica / Spic / Σμίλη αιχμηρού άκρου / Cincel / Scalpello a punta / Cinzel / Poinçon / Puntbeitel

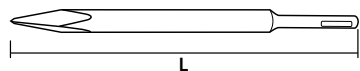

Ref.	ø [mm]	L [mm]	Type		EAN
57H556	14	250	SDS-plus	15/60	5902062575562
57H561	18	400	SDS-max	13/26	5902062575616

Dłuto

Chisel / Beitel / Долово / Зубуно / Laposvéső / Daltă / Dláto / Sekáč plochý / Sekač / Kaltas / Kalts / Peitel / Сєкач / Sjeкаč / Sekac / Σμίλη / Formón / Scalpello / Raspador / Ciseau / Beitel

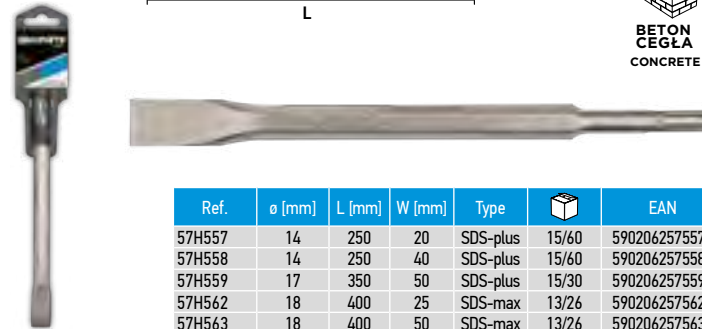
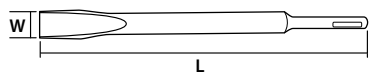

Ref.	ø [mm]	L [mm]	W [mm]	Type		EAN
57H557	14	250	20	SDS-plus	15/60	5902062575579
57H558	14	250	40	SDS-plus	15/60	5902062575586
57H559	17	350	50	SDS-plus	15/30	5902062575593
57H562	18	400	25	SDS-max	13/26	5902062575623
57H563	18	400	50	SDS-max	13/26	5902062575630

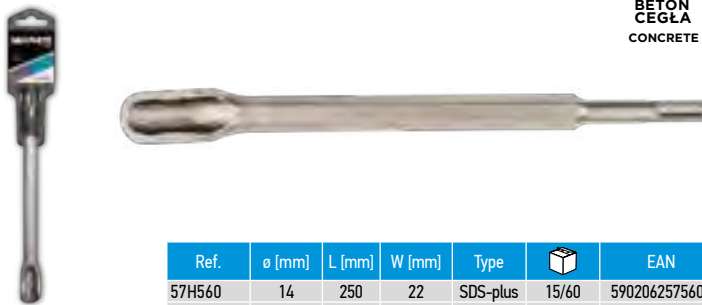

Ref.	ø [mm]	L [mm]	W [mm]	Type		EAN
57H560	14	250	22	SDS-plus	15/60	5902062575609
57H564	18	350	25	SDS-max	13/26	5902062575647

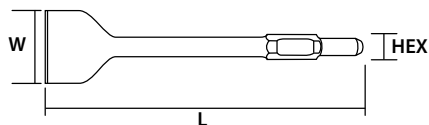

Ref.	HEX [mm]	L [mm]	W [mm]	m [kg]		EAN
57H566	30	400	35	1,5	0/15	5902062575661
57H567	30	400	75	2,4	0/10	5902062575678
57H565	30	400	-	1,5	0/15	5902062575654

Frez z węgla spiekane

Carbide rotary burr / Hartmetall-Drehgrat / Твердосплавная фреза / Твердосплавная фреза / Keresztfogazás / Freza din carbura de tungsten / Tvrdokovová rotační fréza / Fréza z tvrdokovu / Rezalnik iz volframovega karbida / Volframo karbido freza / Volframa karbida fréze / Frees / Фреза / Frezer / Glodalo / Фрѐза / Broca fresadora / Fresa / Fresa / Fraise / Frees



DOUBLE CUT TOOTH **type A** (cylindrical)

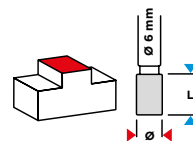

Ref.	ø [mm]	L [mm]		EAN
55H350	6	16	10/100	5902062508942
55H351	8	20	10/100	5902062508959
55H352	10	25	10/100	5902062508966
55H353	12	25	10/100	5902062508973
55H354	14	25	10/100	5902062508980
55H355	16	25	10/100	5902062508997



DOUBLE CUT TOOTH **type B** (cylindrical with blades on top)

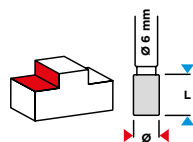

Ref.	ø [mm]	L [mm]		EAN
55H356	8	20	10/100	5902062509000
55H357	10	25	10/100	5902062509017
55H358	12	25	10/100	5902062509024
55H359	16	25	10/100	5902062509031



DOUBLE CUT TOOTH **type C** (cylindrical rounded)

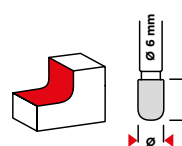

Ref.	ø [mm]	L [mm]		EAN
55H360	10	20	10/100	5902062509048
55H361	12	25	10/100	5902062509055



DOUBLE CUT TOOTH **type D** (spherical)

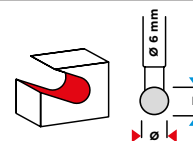

Ref.	ø [mm]	L [mm]		EAN
55H362	10	12	10/100	5902062509062

Frez z węgla spiekane

Carbide rotary burr / Hartmetall-Drehgrat / Твердосплавная фреза / Твердосплавная фреза / Keresztfogazás / Freza din carbura de tungsten / Tvrdokovová rotační fréza / Fréza z tvrdokovu / Rezalnik iz volframovega karbida / Wolframo karbido freza / Wolframa karbida fréze / Frees / Фреза / Frezer / Glodalo / Фрѐза / Broca fresadora / Fresa / Fresa / Fraise / Frees



DOUBLE CUT TOOTH

type E
(oval)

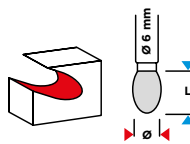

Ref.	ø [mm]	L [mm]		EAN
55H363	6	10	10/100	5902062509079
55H364	8	13	10/100	5902062509086
55H365	10	16	10/100	5902062509093
55H366	12	20	10/100	5902062509109
55H367	14	22	10/100	5902062509116
55H368	16	25	10/100	5902062509123



DOUBLE CUT TOOTH

type G
(tree shape point)

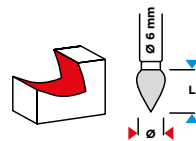

Ref.	ø [mm]	L [mm]		EAN
55H375	12	25	10/100	5902062509192



DOUBLE CUT TOOTH

type H
(flame)

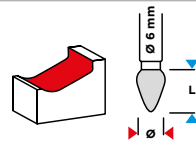

Ref.	ø [mm]	L [mm]		EAN
55H376	12	32	10/100	5902062509208



DOUBLE CUT TOOTH

type L
(conical)

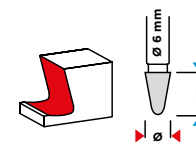

Ref.	ø [mm]	L [mm]		EAN
55H377	12	30	10/100	5902062509215



DOUBLE CUT TOOTH

type F
(tree shape ball nose)

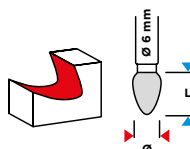

Ref.	ø [mm]	L [mm]		EAN
55H369	6	18	10/100	5902062509130
55H370	8	18	10/100	5902062509147
55H371	10	20	10/100	5902062509154
55H372	12	25	10/100	5902062509161
55H373	14	25	10/100	5902062509178
55H374	16	25	10/100	5902062509185



Frezy

Milling cutters / Fräser / Фрезы / Фрезу / Fenékfúró készlet / Freze / Frézy / Frézy / Rezkala / Frezos / Frézes / Freesid / Фрезу / Frezeri / Glodalice frezeri / Фрѐзес / Brocas fresadoras / Frese / Fresas / Fraises / Frezen

TCT

DREWNO
WOOD

SKLEJKA
CHIPBOARDS

PLASTIC



x12

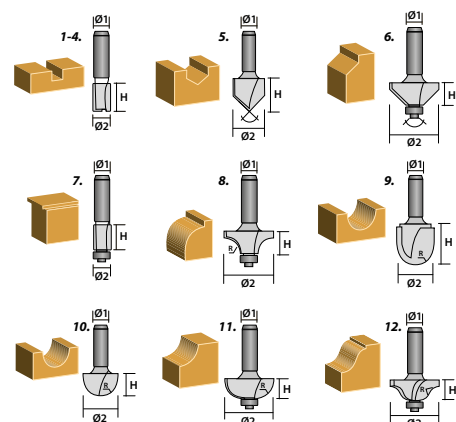

Ref.	NR	ø1 [mm]	ø2 [mm]	α	R [mm]	H [mm]			EAN
57H210	1	8	6			20	12	5/20	5902062572103
		8	12			20			
		8	16			20			
		8	12.7			12			
	5	8	12.7	90		9			
	6	8	32	45		12			
	7	8	12.7			12			
	8	8	22.2		6	12			
	9	8	28.6		9.5	15			
	10	8	12.7		6.35	9			
	11	8	22.2		6	12			
	12	8	25.4		4	15			

POWER IN YOUR HANDS

Frezy

Milling cutters / Fräser / Фрезы / Фрезу / Fenékfúró készlet / Freze / Frézy / Frézy / Rezkala / Frezos / Frēzes / Freesid / Фрезу / Frezeri / Glodalice frezeri / Φρέζες / Brocas fresadoras / Frese / Fresas / Fraises / Frezen

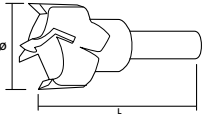

TCT



Ref.	ø [mm]	L [mm]	EAN	Box
57H266	25	60	5902062572660	10/100
57H268	35	60	5902062572684	0/40



GRINDING

x2

HSS



METAL

PLASTIC



DREWNO WOOD

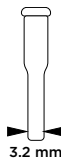

Ref.	ø [mm]	Box	EAN
55H060	7,8	25/100	5902062507174
55H061	6	25/100	5902062507181
55H062	3,2	25/100	5902062507198
55H063	3,14	25/100	5902062507204
55H064	2,95	25/100	5902062507211
55H065	1,4	25/100	5902062507228

Kamienie szlifierskie

Grindstones / Schleifsteine / Камни шлифовальные / Бруски шлифовальні / Csapos köszörűkő készlet / Set piase minipolizor / Brusné kameny / Súprava brúsnych teliesok / Brusilno kamenje / Šlifavimo akmenys / Шліфакмену комплекts / Kšiakivide komplekt / Монтирана точка / Montirana točka / Set kamenja / Λειαντικά πετρώματα / Puntas de amolar / Pietre per rettificatrice / Pedras esmerilhadoras / Meules de rectification / Slijpstenen

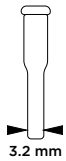

3.2 mm



POLISHING



METAL

x3

DREWNO WOOD



PLASTIC

Ref.	ø [mm]	Box	EAN
55H050	4	25/100	5902062507075
55H051	5	25/100	5902062507082
55H052	10	25/100	5902062507099
55H054	5	25/100	5902062507112
55H055	8	25/100	5902062507129
55H056	6	25/100	5902062507136
55H057	10	25/100	5902062507143
55H058	6	25/100	5902062507150
55H059	10	25/100	5902062507167

Szczotki druciane

Wire brushes / Drahtbürsten / Щетки проволочные / Щітки дротяні / Drátkefék / Perie de sârmă / Drátěné kartáče / Drótené kefy / Žične ščetke / Vieliniai šepėčiai / Stieplu sukas / Terasharjad / Телени четки / Žičane četke / Žičane četke / Βούρτσες αμμήτινες / Cepillos de alambre / Spazzole in fili d'acciaio / Escovas de arame / Broses métalliques / Draadborstels

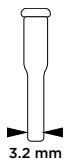

3.2 mm



POLISHING

x3

METAL

DREWNO WOOD

PLASTIC

Ref.	ø [mm]	info	Box	EAN
55H066	5, 15, 20	steel	25/100	5902062507235
55H067	5, 15, 20	brass	25/100	5902062507242
55H068	5, 15, 20	nylon	25/100	5902062507259

Taśma szlifierska

Sanding band / Schleifband / Пескоструйная лента / Шліфувальна стрічка / Csizsoló szalag / Benzi abrazive / Brusný pás / Brúsný pás / Brusilni trak / Šlifavimo juosta / Šlipėšanas josla / Lihvimisriba / Шлифовъчна лента / Traka za brušenje / Traka za брушење / Μπάντα λείανσης / Banda de lijado / Banda abrasiva / Banda de lixa / Bande de ponçage / Schuurband



GRINDING

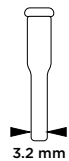

3.2 mm



METAL



DREWNO
WOOD

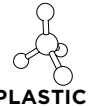

PLASTIC

Ref.	ø [mm]	info		EAN
55H069	6,3	K60 - x5, K120 - x5	25/100	5902062507266
55H070	12,7	K60 - x5, K120 - x5	25/100	5902062507273
55H076	6,3	K60, K80, K120, K240 - x100	25/50	5902062507334
55H077	12,7	K60, K80, K120, K240 - x100	25/50	5902062507341

Tarcza szlifierska

Grinding disc / Schleifscheibe / Круг шлифовальный / Диск шлифовальный / Köszörűkorong / Inel de șlefuire / Leštící kotouč / Kotúč na stolovú brúsku / Brusilna plošča / Šlifavimo diskas / Šlipdiskas / Lihvimisketas / Диск за шмурзел / Brusna ploča / Brusna ploca / Δίσκος λείανσης / Disco para amoladora de banco / Disco per rettificatrice da banco / Disco p. esmerilhar metal / Meule abrasive / Slijpschijf



x10

GRINDING



METAL



DREWNO
WOOD

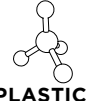

PLASTIC

Ref.	ø [mm]	info		EAN
55H071	20	K150 - x10	25/100	5902062507280

Tarcza tnąca

Cutting disc / Schneidescheibe / Диск отрезной / Диск ризальний / Vágótárcsa / Disc tăietor / Pílový kotouč / Pílový kotúč / Rezilna plošča / Pjovimo diskas / Žąga disks / Låikeketas / Режущий диск / Rezna ploča / Ploče za sečenje / Δίσκος κοπής / Disco de corte / Mola da taglio / Disco cortante / Disque de coupage / Snijschijf

CUTTING



METAL



DREWNO
WOOD



PLASTIC

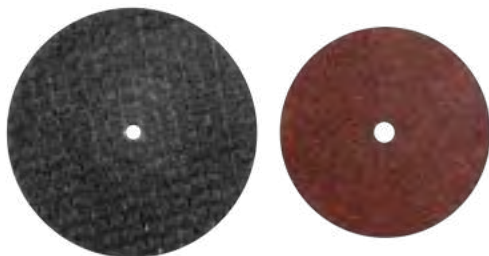

Ref.	ø [mm]	info		EAN
55H072	32	x10	25/100	5902062507297
55H073	24	x30	25/100	5902062507303

Trzpień

Shank / Stift / Штырь / Хвостовик / Csap / Dorn / Kolík / Hrot / Gred / Ašis / Tapa / Varras / Шифт / Klin / Vreteno, stožer / Πείρος / Vástago / Codolo / Fuso / Mandrin / Schenkel

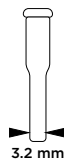

3.2 mm



x2

Ref.	ø [mm]	info		EAN
55H074	3,2	x2	25/100	5902062507310

Wiertła

Drills / Bohrer / Сверла / Сверла / Fúrósáarak / Burghii / Vrtáky / Vrtáky / Svedri / Gražtai / Urbji / Puurid / Сврелна / Svrdla / Burgije / Трпунávia / Brocas / Punte da trapano / Brocas / Forêts / Boren /

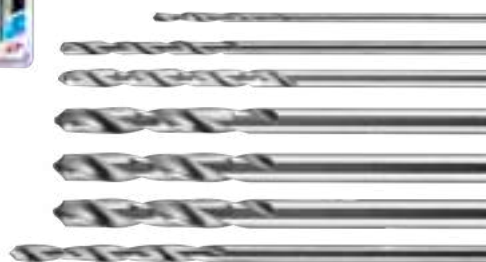

x7



METAL



PLASTIC



DREWNO
WOOD

Ref.	ø [mm]			EAN
55H075	0.8, 1.2, 1.6, 2.0, 2.4, 3.2x2		25/100	5902062507327

Akcesoria do miniwiertarki

Minidrill accessories / Zubehör für Minibohrmaschine / Аксессуары для мини-дрели / Принадлежности до мини-дрели / Tartozékok minifúrógéphez / Accesorii mini masina de gaurit / Příslušenství pro minivrtáčku / Příslušenstvo k minivrtáčke / Pribor za minivrtalnik / Mini suktuvo priedai / Miniurbjmašinas piederumi / Minikruvikeeraja tarvikud / Аксесоари за минипробивна машина / Pribor za minibušilicu / Pribor za mini bušilicu / Αξεσουάρ για μικροδράπανο / Accesorios para mini taladro / Accessori per minitrapano / Acessórios para mini berbequim / Accessoires pour mini perceuse / Accessoires voor miniboormachine



POLISHING

x15



METAL



DREWNO
WOOD



PLASTIC

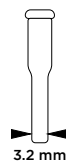

3.2 mm



Ref.	ø [mm]			EAN
55H078	5, 15, 22, 25		25/50	5902062507358

POWER IN YOUR HANDS

Akcesoria do miniwiertarki

Minidrill accessories / Zubehör für Minibohrmaschine / Аксессуары для мини-дрели / Принадлежности до мінідріля / Tartozékok minifúrógéphez / Accessorii mini masina de gaurit / Příslušenství pro minivrtáčku / Příslušenstvo k minivrtáčke / Pribor za minivrtalnik / Mini suktuvo priedai / Miniurbjmašinas piederumi / Minikruvikeeraja tarvikud / Аксесоари за минипробивна машина / Pribor za minibušilicu / Pribor za mini bušilicu / Αξεσουάρ για μικροβόρπανο / Accesorios para mini taladro / Accessori per minitrapano / Acessórios para mini berbequim / Accessoires pour mini perceuse / Accessoires voor miniboormachine

GRINDING

x11



Ref.	Box	EAN
55H079	25/50	5902062507365

POLISHING

x12

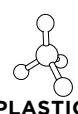
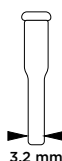

Ref.	Ø [mm]	Box	EAN
55H080	25	25/50	5902062507372

GRINDING

x24

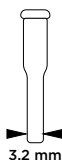
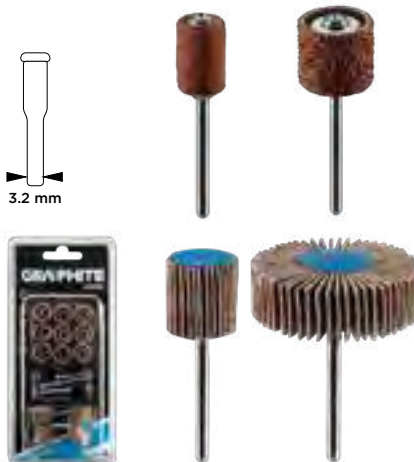

Ref.	Box	EAN
55H081	25/50	5902062507389

GRINDING

x52

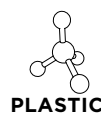
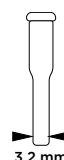

Ref.	Box	EAN
55H082	25/50	5902062507396

POLISHING

GRINDING

x99

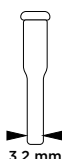

Ref.	Box	EAN
55H084	10/20	5902062507402

POLISHING

GRINDING

x286

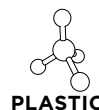
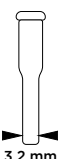

Ref.	Box	EAN
55H085	5/10	5902062507419

Wiertła do drewna

Wood drills / Holzbohrer / Сверла по дереву / Сверла по дереву / Fafúró / Burghie pentru lemn / Vrtáky do dřeva / Vrtáky do dreva / Svedra za les / Gražtai medžiui / Urbji koksnei / Puidupuuriid / Сврелна за дрвресина / Svrdlo za drvo / Brgije za drvo / Τρυπάνια ξύλου / Brocas para madeira / Punta per legno / Brocas p. madeira / Forêts de bois / Boren voor hout

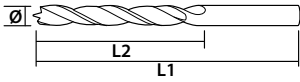

Ref.	ø [mm]	L1 [mm]	L2 [mm]		EAN
57H270	3	60	30	50/400	5902062572707
57H271	4	70	40	50/400	5902062572714
57H272	5	85	45	50/400	5902062572721
57H273	6	90	50	50/400	5902062572738
57H274	7	105	60	50/400	5902062572745
57H275	8	110	65	50/400	5902062572752
57H276	10	120	75	50/200	5902062572769

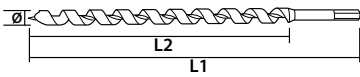

Ref.	ø [mm]	L1 [mm]	L2 [mm]		EAN
57H352	6	250	150	25/200	5902062573520
57H354	8	250	150	25/200	5902062573544
57H356	10	250	150	25/200	5902062573568
57H358	12	250	150	25/150	5902062573582
57H360	14	250	150	25/100	5902062573605
57H362	16	250	150	25/100	5902062573629
57H364	18	250	150	15/60	5902062573643
57H366	20	250	150	15/60	5902062573667
57H368	22	250	150	15/60	5902062573681
57H370	24	250	150	15/60	5902062573704
57H372	25	250	150	15/60	5902062573728
57H252	8	400	300	25/50	5902062572523
57H253	10	400	300	25/50	5902062572530
57H254	12	400	300	25/50	5902062572547
57H255	14	400	300	25/50	5902062572554
57H256	16	400	300	25/50	5902062572561
57H257	18	400	300	25/50	5902062572578
57H258	20	400	300	25/50	5902062572585
57H259	25	460	360	15/30	5902062014894
57H251	30	460	360	10/20	5902062014887



Ref.	ø [mm]			EAN
57H269	4, 5, 6, 8, 10	5	25/100	5902062025425

Wiertła do drewna łopatkowe

Wood flat drill bit / Holzbohrer / Сверло перьевое по дереву / Сверло по дереву перове / Lapos marófúró / Burghiu lat pentru lemn / Vrták lopatkový na dřevo / Vrták do dreva plochý / Sveder za les / Plokščias gražtas medžiui / Spalvu urbis kokam / Lame puidudrelli otsik / Burgija za beton / Τρυπάνια φτερού για διάτρηση ξύλου / Broca de pala para madeira / Punta per legno piatta / Broca de pá p. madeira / Foret à bois plat / Vlakboor voor hout

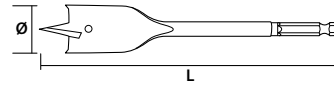

Ref.	ø [mm]	L [mm]		EAN
57H212	6	152	40/240	5902062572127
57H214	8	152	40/240	5902062572141
57H216	10	152	40/240	5902062572165
57H218	12	152	40/240	5902062572189
57H220	14	152	40/240	5902062572202
57H222	16	152	40/240	5902062572226
57H224	18	152	40/240	5902062572240
57H226	20	152	40/240	5902062572264
57H228	22	152	40/240	5902062572288
57H230	24	152	40/240	5902062572301
57H232	26	152	40/240	5902062572325
57H234	28	152	40/240	5902062572349
57H236	30	152	40/240	5902062572363
57H238	32	152	40/240	5902062572387
57H240	34	152	40/240	5902062572400
57H242	38	152	40/240	5902062572424
57H244	40	152	40/240	5902062572448



Ref.	ø [mm]			EAN
57H211	10, 12, 16, 18, 20, 25	6	10/40	5902062025432

Przedłużka do wiertel

Extension / Verlängerung / Удлинитель / Подовжувач / Toldósár laposmarófúróhoz / Prelungitor / Prodlužovák / Predženie / Podaljšek / Ilgiklis / Pagarinātājs / Pikendus / Удължител / Produženi poluga / Produžena poluga / Προέκταση / Alargadera / Prolunga per punte piatte per legno / Extensão / Prolongation / Verlengstuk

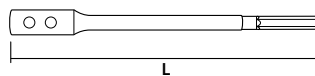

Ref.	L [mm]		EAN
57H245	150	25/100	5902062572455

POWER IN YOUR HANDS

Wiertła-pily

Saw drills / Bohrer - Säge / Сверла-пилы / Свердла-фрезы / Marófúró készlet / Burghie - ferästräu / Vrtáky / Pily / Frézovací vrták / Svedri-žage / Gražtai - pjūklai / Urbji-zāģi / Puurid-saed / Средла-триони / Svrdla pile / Burgije-testere / Πρωτόι τρυπάνια / Brocas sierras / Set punta seghettata / Forêts-scies / Boorzagen

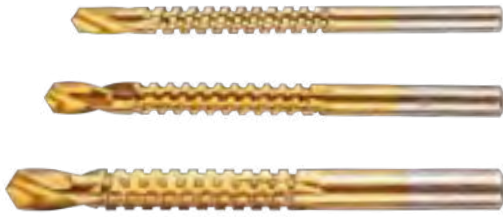

Ref.	ø [mm]		EAN
57H250	5, 6, 8	12/60	5902062572509

Otwornica

Compass saw / Lochsäge / Ножовка / Фреза / Körkivágó készlet / Ferästräu pentru găuri / Děrovka / Dierovacía píla / Luknjarica / Vienarankis pjūklas / Rokzāģis / Augusaag / Тесен трион / Nareznica / Ručna testera za pravljenje otvora / Πριόνι / Sierra de corona / Set sega a tazza / Serra para recorte / Scie à guichet / Gatknipper

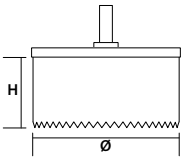

Ref.	ø [mm]	H [mm]		EAN	
57H957	28, 35, 50, 68, 75	30	5	6/36	5902062579577

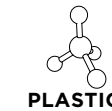
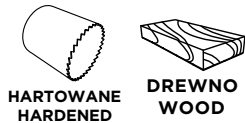

Smar

Grease / Schmierstoff / Смазочное масло / Масло / Zsír fűrókapácsolhoz / Unsoare consistentă / Mazivo / Mazivo / Mazivo / Terpalas / Smēreļļa / Määre / Смазка / Nazivo / Mazivo / Γράσο / Engrase /Grasso per mandrini / Lubrificante / Graisse / Smeer

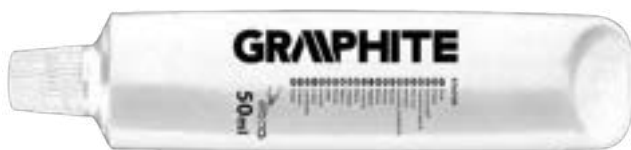

Ref.			EAN
57H745	50ml	0/50	5902062577450

Tarcze diamentowe

Diamond discs / Diamantschleifscheibe / Алмазные круги / Диск диамантовый / Gyémánt vágókorong / Discuri diamentate / Diamantové kotouče / Diamantové kotúče / Diamantne plošče / Deimantiniai diskai / Dimantu diskai / Teemantkettad / Διαμαντηνου δισκουε / Dijamantne ploče / Ploče za dijamante / Διαμαντοροχοές / Disco de diamante / Disco diamantato da taglio / Discos de diamante / Disques diamantés / Diamantschijven

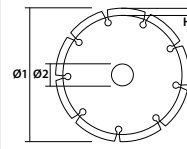

Ref.	ø1 [mm]	ø2 [mm]	H [mm]	W [mm]		EAN
57H606	125	22.2	8.0	2.2	50/100	5902062576064
57H610	230	22.2	8.0	2.5	0/25	5902062576101

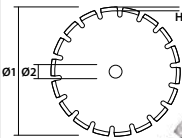
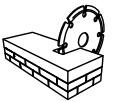

Ref.	ø1 [mm]	ø2 [mm]	H [mm]	W [mm]		EAN
57H614	350	25.4	10.0	3.2	0/10	5902062576149

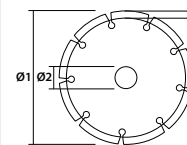

Ref.	ø1 [mm]	ø2 [mm]	H [mm]	W [mm]		EAN
57H616	115	22.2	8.0	2.1	50/100	5902062576163
57H617	125	22.2	8.0	2.2	50/100	5902062576170
57H618	180	22.2	8.0	2.5	10/50	5902062576187
57H870	200	25.4	8.0	2.5	0/50	5902062578709
57H619	230	22.2	8.0	2.7	0/25	5902062576194



Tarcze diamentowe

Diamond discs / Diamantschleifscheibe / Алмазные круги / Диск диамантовий / Gyémánt vágókorong / Discuri diamantate / Diamantové kotouče / Diamantové kotúče / Diamantne plošče / Deimantiniai diskai / Dimantu diskai / Teemantkettad / Диамантени дискове / Dijamantne ploče / Ploče za dijamante / Διαμαντοτορρός / Disco de diamante / Disco diamantato da taglio / Discos de diamante / Disques diamantés / Diamantschijven

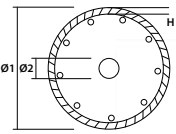

MPA
ENT3256

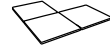
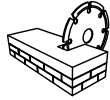

CERAMIKA
CERAMIC



SUPER
CIENKA
SUPER
THIN



DIAMENTOWE
OSTRZE
DIAMOND
BLADE



Ref.	ø1 [mm]	ø2 [mm]	H [mm]	W [mm]		EAN
57H620	115	22.2	6.0	1.3	50/100	5902062576200
57H621	125	22.2	6.0	1.4	50/100	5902062576217
57H872	200	25.4	6.0	1.6	0/50	5902062578723
57H623	230	22.2	6.0	1.8	0/25	5902062576231

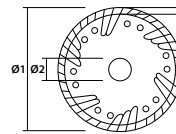

MPA
ENT3256

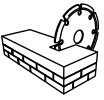

DIAMENTOWE
OSTRZE
DIAMOND
BLADE



Ref.	ø1 [mm]	ø2 [mm]	H [mm]	W [mm]		EAN
57H625	115	22.2	6.0	2.4	50/100	5902062576255
57H626	125	22.2	6.0	2.6	50/100	5902062576262
57H628	180	22.2	6.0	2.8	10/50	5902062576286
57H871	200	25.4	6.0	2.8	0/50	5902062578716
57H630	230	22.2	6.0	3.1	0/25	5902062576309

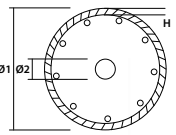

MPA
ENT3256



DIAMENTOWE
OSTRZE
DIAMOND
BLADE



Ref.	ø1 [mm]	ø2 [mm]	H [mm]	W [mm]		EAN
57H632	115	22.2	6.0	2.4	50/100	5902062576323
57H634	125	22.2	6.0	2.6	50/100	5902062576347
57H636	180	22.2	6.0	2.8	10/50	5902062576361
57H638	230	22.2	6.0	3.1	0/25	5902062576385

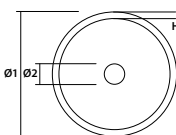

MPA
ENT3256



DIAMENTOWE
OSTRZE
DIAMOND
BLADE

CIĘCIE
NA MOKRO
WET CUT



Ref.	ø1 [mm]	ø2 [mm]	H [mm]	W [mm]		EAN
57H640	115	22.2	6.0	2.1	50/100	5902062576408
57H642	125	22.2	6.0	2.2	50/100	5902062576422
57H644	180	22.2	6.0	2.5	10/50	5902062576446
57H874	200	25.4	6.0	2.5	0/50	5902062578747
57H646	230	22.2	6.0	2.7	0/25	5902062576460
57H645	250	25.4	6.0	2.7	0/25	5902062507556

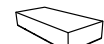
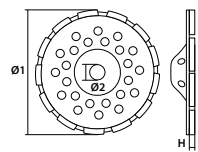

BETON
CONCRETE



DIAMENTOWE
OSTRZE
DIAMOND
BLADE



Ref.	ø1 [mm]	ø2 [mm]	H [mm]		EAN
57H884	125	22.2	5.0	10/20	5902062578846

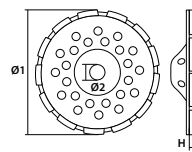

BETON
CONCRETE



DIAMENTOWE
OSTRZE
DIAMOND
BLADE



Ref.	ø1 [mm]	ø2 [mm]	H [mm]		EAN
57H886	115	22.2	5.0	10/20	5902062578860
57H887	125	22.2	5.0	10/20	5902062578877
57H888	180	22.2	5.0	5/10	5902062578884

POWER IN YOUR HANDS

Tarcze diamentowe

Diamond discs / Diamantschleifscheibe / Алмазные круги / Диск диамантовый / Gyémánt vágókorong / Discursi diamentate / Diamantové kotouče / Diamantové kotúče / Diamantne plošče / Deimantiniai diskai / Dimantu diski / Teemantkettad / Диамантени дискове / Dijamantne ploče / Ploče za dijamante / Διαμαντοπόχος / Disco de diamante / Disco diamantato da taglio / Discos de diamante / Disques diamantés / Diamantschijven

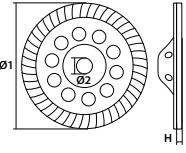

**BETON
CONCRETE**



**DIAMANTOWE
OSTRZE
DIAMOND
BLADE**



Ref.	ø1 [mm]	ø2 [mm]	H [mm]		EAN
57H889	115	22.2	5.0	10/20	5902062578891
57H890	125	22.2	5.0	10/20	5902062578907

Otwornica

Compass saw / Lochsäge / Ножовка / Фреза / Lyukfúró / Ferästräu pentru găuri / Děrovka / Dierovacía pila / Luknjariča / Vienarankis pjūklas / Rokzāģis / Augusaag / Тесен трион / Nareznica / Ručna testera za pravljenje otvora / Πριόνι / Sierra de corona / Segá a tazza diamentata / Serra para recorte / Scie à guichet / Gatenknipper

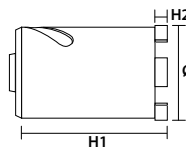

**BETON
CONCRETE**



**DIAMANTOWE
OSTRZE
DIAMOND
BLADE**



Ref.	ø1 [mm]	H1 [mm]	H2 [mm]		EAN
57H875	62	75	8	5/10	5902062578754
57H876	68	75	8	5/10	5902062578761
57H877	72	75	8	5/10	5902062578778
57H878	82	75	8	5/10	5902062578785

Akcesoria do otwornic

Accessories for hole cutters / Zubehör für Lochsägen / Принадлежности для корончатых сверл / Приналежности до фрез / Körkivágó tartozékok / Accesorii de ferăstrău pentru orificii / Příslušenství pro děrovky / Prislushestvo k dierovacím pilám / Pribor za luknjariče / Priedai vienarankiam pjūklui / Liela diametra urbju aksesuāri / Kroonpuuride tarvikud / Аксесоари за тесни триони / Pribor za bušaće rupa / Pribor za testeru za pravljenje otvora / Εξαρτήματα για ποτρωτήρινα / Accesorios para sierras de corona / Accessoires voor gatenknipper

57H879



57H880



57H881



Ref.	Info		EAN
57H879	SDS-plus	10/50	5902062578792
57H880	HEX	10/50	5902062578808
57H881	6.5 x 10 mm	10/50	5902062578815

Tarcze do pilarki

Circular saw blade / Sägeblatt / Диск пильный / Диск пильный до пилки циркулярной / Körfürészlap keményfém / Lamā circularā p/u ferāstrāu / Pilový kotouč / Pilový kotúč / List za krožno žago / Pjovimo diskas pjūklui / Zāga rīpa / Kreissaecketas / Диск за циркуляр / Kružna pila / List kruzne testere / Δίσκος κοπής διακοπρίωνου / Disco de corte para sierra circular / Lama per sega circolare / Disco p. disco de limar / Disque à scie rotative / Schijf voor slijpmachine

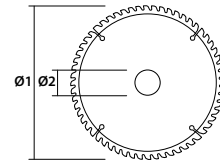

TCT

**DREWNO
WOOD**

**SKLEJKA
CHIPBOARDS**

Ref.	ø1 [mm]	ø2 [mm]		W1 [mm]	W2 [mm]			EAN
57H654	165	30	30	2.0	2.8	30x20 ; 30x25.4 ; 30x16	35/70	5902062576545
57H656	160	30	18	2.0	2.8	30x20 ; 30x25.4 ; 30x16	0/70	5902062576569
57H658	160	30	24	2.0	2.8	30x20 ; 30x25.4 ; 30x16	35/70	5902062576583
57H660	160	30	30	2.0	2.8	30x20 ; 30x25.4 ; 30x16	35/70	5902062576606
55H603	160	30	48	2.0	2.8	30x20 ; 30x25.4 ; 30x16	50/100	5902062997500
57H650	165	30	24	2.0	2.8	30x20 ; 30x25.4 ; 30x16	50/100	5902062576507
57H652	165	30	30	2.0	2.8	30x20 ; 30x25.4 ; 30x16	0/70	5902062576521
55H604	180	30	40	2.0	2.8	30x20 ; 30x25.4 ; 30x16	25/50	5902062997517
55H605	180	30	60	2.0	2.8	30x20 ; 30x25.4 ; 30x16	25/50	5902062997524
57H662	185	30	24	2.0	2.8	30x20 ; 30x25.4 ; 30x16	25/50	5902062576620
57H664	185	30	36	2.0	2.8	30x20 ; 30x25.4 ; 30x16	25/50	5902062576644
55H600	185	30	40	2.0	2.8	30x20 ; 30x25.4 ; 30x16	25/50	5902062997470
57H666	185	30	48	2.0	2.8	30x20 ; 30x25.4 ; 30x16	50/50	5902062576668
55H601	185	30	60	2.0	2.8	30x20 ; 30x25.4 ; 30x16	25/50	5902062997487
57H668	190	30	24	2.2	3.2	30x20 ; 30x25.4 ; 30x16	25/50	5902062576682
57H670	190	30	40	2.2	3.2	30x20 ; 30x25.4 ; 30x16	25/50	5902062576705
57H672	190	30	50	2.2	3.2	30x20 ; 30x25.4 ; 30x16	25/50	5902062576729
57H674	200	30	24	2.2	3.2	30x20 ; 30x25.4 ; 30x16	20/40	5902062576743
57H676	200	30	40	2.2	3.2	30x20 ; 30x25.4 ; 30x16	20/40	5902062576767
57H678	200	30	60	2.2	3.2	30x20 ; 30x25.4 ; 30x16	20/40	5902062576781
57H682	205	30	36	2.2	3.2	30x20 ; 30x25.4 ; 30x16	25/50	5902062576828
57H679	216	30	36	2.2	3.2	30x20 ; 30x25.4 ; 30x16	0/50	5902062576798
57H680	216	30	48	2.2	3.2	30x20 ; 30x25.4 ; 30x16	0/40	5902062576804
57H681	216	30	60	2.2	3.2	30x20 ; 30x25.4 ; 30x16	0/40	5902062576811
57H684	250	30	40	2.2	3.2	30x20 ; 30x25.4 ; 30x16	0/25	5902062576842
57H686	255	30	40	2.2	3.2	30x20 ; 30x25.4 ; 30x16	0/30	5902062576866
55H606	300	30	40	2.2	3.2	30x20 ; 30x25.4 ; 30x16	20/20	5902062997531
55H607	315	30	40	2.2	3.2	30x20 ; 30x25.4 ; 30x16	20/20	5902062997548
55H608	400	30	40	2.2	3.2	30x20 ; 30x25.4 ; 30x16	20/20	5902062997555

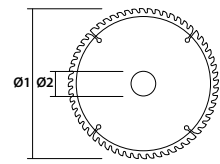

TCT

AL

Ref.	ø1 [mm]	ø2 [mm]		W1 [mm]	W2 [mm]			EAN
57H654	165	30	30	2.2	3.2	30x20 ; 30x25.4 ; 30x16	0/70	5902062576545
55H610	210	30	100	2.2	3.2	30x20 ; 30x25.4 ; 30x16	0/50	5902062997979
55H695	235	30	100	2.0	2.8	30x20 ; 30x25.4 ; 30x16	0/25	5902062500991
55H611	250	30	100	2.2	3.2	30x20 ; 30x25.4 ; 30x16	0/30	5902062997586

Tarcza tnąca

Cutting disc / Schneidescheibe / Диск пильный / Диск різальний / Vágókorong / Disc tăietor / Pilový kotouč / Pilový kotúč / Rezinna plošča / Pjovimo diskas / Ząga disks / Löikeketas / Режущий диск / Rezna ploča / Ploče za sečenje / Δίσκος κοπής / Disco de corte / Disco da taglio per metallo / Disco cortante / Disque de coupe / Snijdschijven

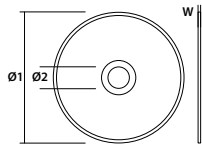

METAL

Ref.	ø1 [mm]	ø2 [mm]	W [mm]	Info		EAN
57H700	125	22	1.6	41 A60-T-BF	0/25	5902062577009
57H705	115	22	1.0	41 A60-T-BF	0/25	5902062577054
57H706	115	22	2.5	41 A30-T-BF	0/25	5902062577061
57H707	125	22	1.0	41 A60-T-BF	0/25	5902062577078
57H708	125	22	2.5	41 A30-T-BF	0/25	5902062577085
57H718	180	22	1.6	41 A46-S-BF	0/25	5902062577184
57H719	230	22	1.9	41 A46-S-BF	25/50	5902062577191
57H711	300	32	3.0	41 A24-T-BF	0/25	5902062577115
57H712	350	32	3.5	41 A24-T-BF	25/50	5902062577122
57H738	355	25.4	3.0	41 A30-T-BF	0/1	5902062577382
57H713	400	32	4.0	41 A24-T-BF	0/10	5902062577139

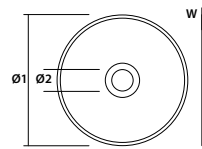

BETON
CEGLA
CONCRETE

Ref.	ø1 [mm]	ø2 [mm]	W [mm]	Info		EAN
57H720	115	22.2	1.6	41 37C30-R-BF	1/25	5902062577207
57H722	125	22.2	1.6	41 37C30-R-BF	1/10	5902062577221
57H724	180	22.2	3.2	42 37C30-R-BF	1/10	5902062577245
57H725	230	22.2	3.2	42 37C30-R-BF	1/10	5902062577252

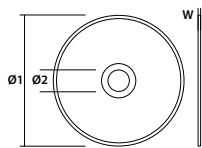

Fe+S+Cl



STAL
NIERDZEWNA
STAINLESS
STEEL



METAL

Ref.	ø1 [mm]	ø2 [mm]	W [mm]	Info	Info		EAN
57H690	125	22	0.8	57A60Z-BF07	FREE OFF Fe+S+CL	0/25	5902062576903
57H730	115	22	1.0	41 A60-T-BF	INOX (Fe+S+Cl<0.1%)	0/50	5902062577306
57H733	125	22	1.0	41 A60-T-BF	INOX (Fe+S+Cl<0.1%)	0/50	5902062577337

Tarcza szlifierska

Grinding disc / Schleifscheibe / Крута шлифовальный / Диск шлифовальный / Tisztítókorong / Inel de șlefuire / Leštící kotouč / Kotúč na stolovú brúsku / Brusilna plošča / Šlifavimo diskas / Slipdisk / Lihvimisketas / Диск за шмурзел / Brusna ploča / Brusna ploca / Δίσκος λείανσης / Disco para amoladora de banco / Disco per rettificare per metallo / Disco p. esmerilhar metal / Meule abrasive / Slijpschijf

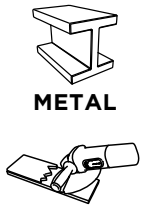
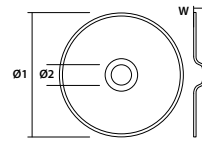

METAL

Ref.	ø1 [mm]	ø2 [mm]	W [mm]	Info		EAN
57H714	115	22	6.4	27 A30-S-BF	0/10	5902062577146
57H715	125	22	6.4	27 A30-S-BF	0/10	5902062577153
57H717	230	22	6.4	27 A24-S-BF	0/10	5902062577177

Szczotka druciana

Wire brush / Drahtbürste / Щетка проволочная / Щітка по металу / Fazékkefe sodrott / Perie metal / Drátěný kartáč / Kefa drátěná univerzálna / Žična krtača / Vielinis šepetys / Drāšu birste / Traathari / Четка мелена / Četka sa PVC drškom / Cetka / Συμπύκτη βούρτσα / Cepillo de alambre / Spazzola a tazza / Escova de arame / Brosse métallique / Draadborstel

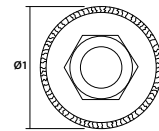

INOX
Ø0.5mm



M14



STAL
NIERDZEWNA
STAINLESS
STEEL



METAL

Ref.	Ø1 [mm]	n _p max [min ⁻¹]		EAN
57H581	65	12 500	6/60	5902062575814
57H582	80	12 500	6/60	5902062575821
57H583	100	8 500	6/30	5902062575838

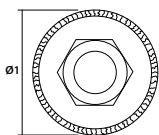

INOX
Ø0.5mm



M14



STAL
NIERDZEWNA
STAINLESS
STEEL



METAL

Ref.	Ø1 [mm]	n _p max [min ⁻¹]		EAN
57H585	65	12 500	6/60	5902062575852
57H587	100	8 500	6/18	5902062575876

Szczotka druciana

Wire brush / Drahtbürste / Щетка проволочная / Щітка по металу / Fazékkéfe sodrott / Perie metal / Drátěný kartáč / Kefa drôtená univerzálna / Žična krtača / Vielinis šepetys / Drāšu birste / Traathari / Четка телена / Četka sa PVC drškom / Četka / Συρμάτινη βούρτσα / Cepillo de alambre / Spazzola a tazza / Escova de arame / Brosse métallique / Draadborstel





Ref.	Ø1 [mm]	n _r max [min ⁻¹]	📦	EAN
57H589	100	12 500	6/60	5902062575890
57H591	115	12 500	0/60	5902062575913









Ref.	Ø1 [mm]	Ø2 [mm]	n _r max [min ⁻¹]	📦	EAN
57H599	50	6,1	4 500	12/120	5902062575999
57H600	75	6,1	4 500	12/120	5902062576002



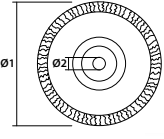

Ref.	Ø1 [mm]	n _r max [min ⁻¹]	📦	EAN
57H596	115	12 500	6/60	5902062575968
57H598	125	12 500	6/60	5902062575982

Ref.	Ø1 [mm]	Ø2 [mm]	n _r max [min ⁻¹]	📦	EAN
57H601	50	6,25	4 500	12/120	5902062576019
57H602	75	6,25	4 500	12/120	5902062576026





Ref.	Ø1 [mm]	Ø2 [mm]	n _r max [min ⁻¹]	🌀	📦	EAN
57H592	125	20	8 500	16, 12 mm	6/60	5902062575920

Brzeszczot

Bow saw blade / Sägeblatt / Полотно ножовочное / Полотно до ножічки лучкової / Fűrészlap multifunkciós géphez / Lama ferästräu cu arc / List pily / Plátok náhradný / Rezilni list / Geleżtë / Asmenis lokzägim / Vibusae leht / Лист за трион бичкыя / List Pile / List testere / Λεπίδα για τοξοπίλιο / Hoja de sierra de arco / Lama per metallo HSS / Lâmina / Lame de scie





Ref.	W [mm]	📦	EAN
56H050	34	10/100	5902062019660
56H051	20	10/100	5902062019677
56H052	10	10/100	5902062019684

Brzeszczot

Cutting disc / Schneidescheibe / Диск пильный / Диск різальний / Vágókorong / Disc tăietor / Pílový kotouč / Pílový kotúč / Rezilna plošča / Pjovimo diskas / Ząga disks / Lāikeketas / Режущий диск / Rezna ploča / Ploče za sečenje / Δίσκος κοπής / Disco de corte / Disco da taglio per metallo / Disco cortante / Disque de coupage / Snijerschijven



CERAMIKA CERAMIC

DIAMENTOWE OSTRZE DIAMOND BLADE

Ref.	W [mm]		EAN
56H053	68	10/200	5902062019691



HCS

TRÓJSTRONNIE OSTRZONE ZĘBY 3-BLADE TEETH

DREWNO WOOD

Ref.	W [mm]		EAN
56H054	34	10/100	5902062019707



HSS

METAL

Ref.	W [mm]		EAN
56H006	34	5/150	5902062690067



BI-METAL Co 8%

METAL

Ref.	W [mm]		EAN
56H055	34	10/100	5902062019714
56H056	20	10/100	5902062019721
56H057	10	10/100	5902062019738



HCS

DREWNO WOOD

Ref.	W [mm]		EAN
56H008	20	5/150	5902062690081

Tarcza półokrągła

Half-round blade / Halbrunde Schneidescheibe / Диск полукруглый / Півкруглий диск / Hss félkör vágólap / Disc semirotund / Půlkruhový kotouč / Polkruhový kotuč / Polkrožna plošča / Pusapvalis diskas / Pusaraš disks / Poolringikujuline ketas / Полукръгъл диск / Poluokrugla ploča / Polukružna ploča / Ημικυκλικός δίσκος / Disco semicircular / Lama semicircolare HSS per metallo / Disco semiredondo / Disque demirond



HSS

METAL

Ref.	W [mm]		EAN
56H061	87	10/100	5902062019776



HCS

DREWNO WOOD

Ref.	W [mm]		EAN
56H062	87	10/100	5902062019783



HCS

CERAMIKA CERAMIC

DIAMENTOWE OSTRZE DIAMOND BLADE

Ref.	Ø1 [mm]		EAN
56H063	65	10/100	5902062019790



CERAMIKA CERAMIC

Ref.	Ø1 [mm]		EAN
56H064	64	10/100	5902062019806

Tarcza półokrągła

Half-round blade / Halbrunde Schneidscheibe / Диск полукруглый / Πιστοκρηλίου δίσκος / Hss félkör vágólap / Disc semirond / Půlkruhový kotouč / Polkruhový kotuč / Polkrožna plošča / Pusarvalis diskas / Pusarajš disks / Poolringikujuline ketas / Полуокръгъл диск / Poluokrugla ploča / Polukružna ploča / Ημικυκλικός δίσκος / Disco semicircular / Lama semicircolare HSS per metallo / Disco semiredondo / Disque demirond

HCS



DREWNO
WOOD



Ref.	W [mm]	Icon	EAN
56H002	85	5/150	5902062690029

Brzeczoty

Blades / Sägeblätter / Полотна / Полотна пильні / Vágó lapok / Pânze de ferăstrău / Pilové listy / Pílové listy / Listi / Ριζκλιουκai / Asmeni / Saelehed / Листове за трион / Listovi pile / Sečiva / Приονόλαμες / Hojas / Set lame da taglio per legno / Láminas / Lames de scie / Mesbladen



DREWNO
WOOD

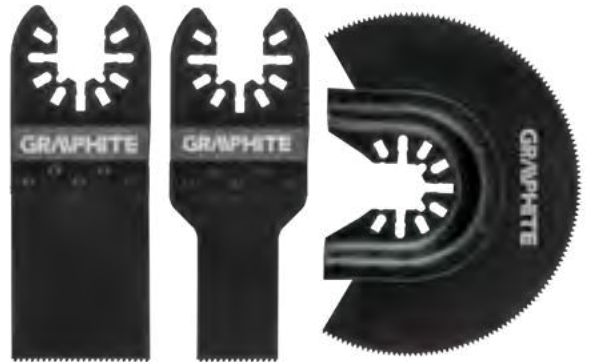

Ref.	Icon	Icon	EAN
56H070	3	10/60	5902062022127



CERAMIKA
CERAMIC



Ref.	W [mm]	Icon	EAN
56H004	85	5/100	5902062690043



METAL



Ref.	Icon	Icon	EAN
56H072	3	10/60	5902062022134

Płytkę ścierna do ceramiki

Finger shaped rasp for ceramics / Schleifplatte zur Keramikbearbeitung / Шлифовальная пластина по керамике / Плитка наждачна до керамики / Кетényfém csiszolólap / Disc șlefuire pentru ceramică / Brusná deska na keramiku / Rašpila na keramiku / Brusilna plošča za keratiko / Keratikos gandymo priedas / Slipēšanas plāksne keramikai / Keraatikalihvimisplaat / Абразивна плоча за керамика / Brusna ploča za keratiku / Plička brusiona ploča za keratiku / Πλάκα λείανσης κεραμικών / Placa de lijado para cerâmica / Lame per smerigliare al carburo di tungsteno per ceramica, HM / Grosa para cerâmica / Plaque abrasive pour céramique



CERAMIKA
CERAMIC



Ref.	W [mm]	Icon	EAN
56H065	76	10/100	5902062019813



CERAMIKA
CERAMIC

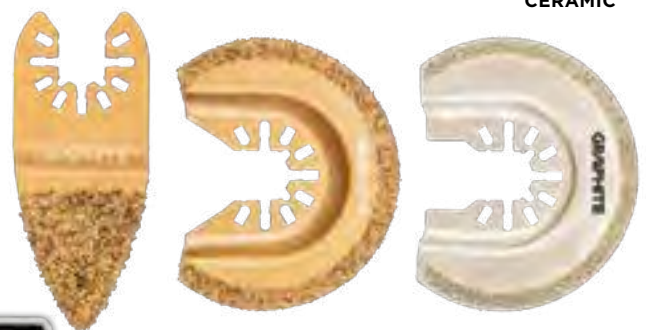

Ref.	Icon	Icon	EAN
56H074	3	10/60	5902062022141

POWER IN YOUR HANDS

Skrobak sztywny

Stiff scraper / Schaber / steif / Скребок жесткий / Скребок жорсткий / Fa kararó multigéphez / Răzuitor rigid / Tuhý škrabák / Tvrdá špachtla / Togo strgalo / Grandiklis tiesus / Stingsr kasiklis / Jäk kaabits / Төгрөд шабър / Kruta strugalica / Grubi šabler / Σκληρή ξύστρα / Rasqueta no elástica / Raschietto rigido per legno / Raspador duro / Racle rigide

HCS



Ref.	W [mm]		EAN
56H010	50	5/150	5902062690104

Papiery szlifierskie

Sanding paper / Schleifpapier / Бумага наждачная / Папір наждачний / Csiszolópapír multigéphez / Hítte şmirghe ce se încheie singură / Brusný papír / Papier brúsny-rolka / Brusni papir / Šlifavito papierius / Smilšpapīrs / Liivapaber / Шкурка руло / Brusni papir u roli / Brusni papir / Λειαντικό ύφασμα / Lija / Carta abrasiva / Folha de lixa / Papier abrasif

x5



Ref.	W [mm]	Info		EAN
56H014	83 x 83 x 83	K60 x 2; K80 x 2; K100 x 1	5/100	5902062690142

Stopa szlifierska

Sanding pad / Schleifteller / Шлифовальная подошва / Шліфувальна поверхня трикутна / Csiszolófej multigéphez / Talpă de șlefuit / Brusná deska / Pracovná päťka brúsky / Brusna plošča / Šlifavimo padas / Slīpēšanas rēda / Lihvtald / Шлифовъчен плот / Brusni tanjur / Postolja za brušenje / Πλάκα λείανσης / Placa lijadora / Piastra levigatrice / Complemento da lixa / Plateau de ponçage



Ref.	W [mm]		EAN
56H012	83 x 83 x 83	5/100	5902062690128



Ref.	W [mm]		EAN
56H013	83 x 83 x 83 mm	5/100	5902062007704

Diamantowy dysk polerski z rzepem

Diamond polishing disc with hook and loop / Diamant-Polierscheibe mit Klettverschluss / Алмазний поліровальний круг на липучке / Круг полірувальний діамантовий на «липучці» / Gyémánt polírozó korong tépőzárral / Disc de lustruit cu diamant cu Velcro / Diamantový leštiaci kotouč se suchým zipem / Diamantový leštiaci kotúč so suchým zipsom / Diamantni polirni disk z velkrom / Deimantinis poliravimo diskas, lipnus / Dimanta pulēšanas disks ar līpvirsmu / Takjakinnitusega teemant-lihvketas / Διαμαντένιος γυαλισματος με Velcro / Disco de pulido de diamante con velcro / Disco diamantato per lucidatura con velcro / Disco polidor de diamante com velcro / Disque de polissage diamanté avec velcro / Diamant polijstpad met klittenband

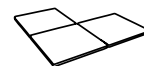
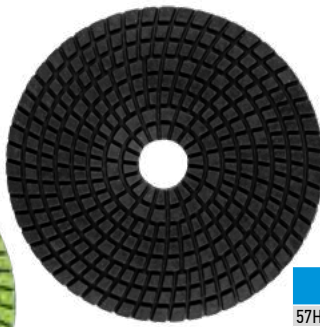
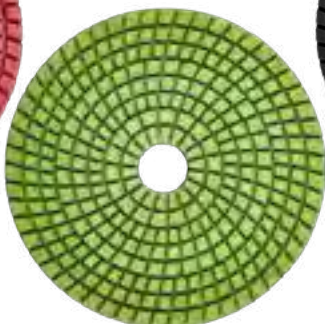
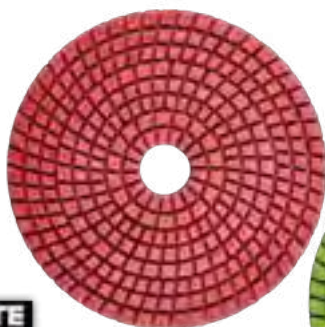

GRESS



DIAMOND



Ref.	Info	Ø [mm]		EAN
57H850	K50	125	0/100	5902062888518
57H851	K100	125	0/100	5902062888525
57H852	K200	125	0/100	5902062888532
57H853	K400	125	0/100	5902062888549
57H854	K800	125	0/100	5902062888556
57H855	K1500	125	0/100	5902062888563
57H856	K3000	125	0/100	5902062888570

GRAPHITE

Ściernica listkowa

Flap wheel / Blatt-Schleifscheibe / Листовой шлифовальный круг / Кругу шлифувальний листковий / Lamellás csiszoló / Disc de rectificat / Brusný kotouč listkový / Brusný lamelový tanier / Brus z lističi / Šlifavimo lapeliai / Lokşnu şlipēšanas riņķis / Lamell-lihvketas / Ламелен диск / Lepezasta brusna ploča / Kolut za brušenje / Τροχός λείανσης με πτερύγια / Abanico lijador / Spazzola lamellare / Disco abrasivo de folhas / Meule abrasive à lamelles / Schuurblad

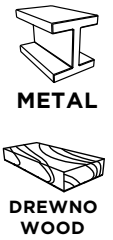

Ref.	Info	Ø [mm]	Box	EAN
57H835	K40	115 x 22.2	20/100	5902062503428
57H836	K60	115 x 22.2	20/100	5902062503435
57H837	K80	115 x 22.2	20/100	5902062503442
57H838	K100	115 x 22.2	20/100	5902062503459
57H839	K120	115 x 22.2	20/100	5902062503466
57H840	K36	125 x 22.2	20/100	5902062997012
57H841	K40	125 x 22.2	20/100	5902062997029
57H842	K60	125 x 22.2	20/100	5902062997036
57H843	K80	125 x 22.2	20/100	5902062997043
57H844	K100	125 x 22.2	0/100	5902062997050
57H845	K120	125 x 22.2	20/100	5902062997067

Ref.	Info	Ø [mm]	Box	EAN
55H980	K36	115 x 22.2	20/100	5902062503305
55H981	K40	115 x 22.2	20/100	5902062503312
55H982	K60	115 x 22.2	20/100	5902062503329
55H983	K80	115 x 22.2	20/100	5902062503336
55H984	K100	115 x 22.2	20/100	5902062503343
55H985	K120	115 x 22.2	20/100	5902062503350
55H986	K36	125 x 22.2	20/100	5902062503367
55H987	K40	125 x 22.2	20/100	5902062503374
55H988	K60	125 x 22.2	20/100	5902062503381
55H989	K80	125 x 22.2	20/100	5902062503398
55H990	K100	125 x 22.2	20/100	5902062503404
55H991	K120	125 x 22.2	20/100	5902062503411

Krażki ściernie

Abrasive discs / Schleifscheibe / Шлифовальные круги / Круги шлифувальні / Csiszolókorongok / Discuri abrazive / Brusné kroužky / Brúsné kotúče / Brusne plošče / Šlifavimo diskeliai / Slipēšanas aplī / Lihvriņģad / Абразивни дискове / Brusni kolutiči / Diskovi za brušenje / Διακοί λείανσης / Hoja de lija circular / Dischi abrasivi / Discos abrasivos / Roulette abrasive / Schuurwielen

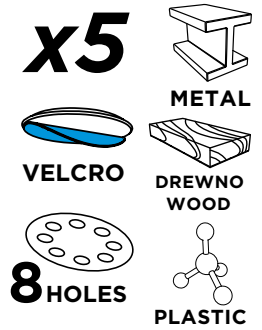
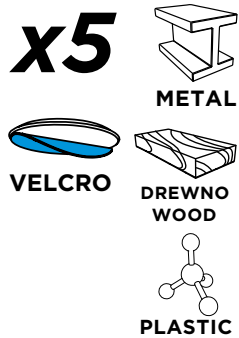

Ref.	Info	Ø [mm]	Box	EAN
55H933	K40	125	5 0/200	5902062502414
55H934	K60	125	5 0/200	5902062502421
55H935	K80	125	5 0/200	5902062502438
55H936	K100	125	5 0/200	5902062502469
55H937	K120	125	5 0/200	5902062502476
55H938	K240	125	5 0/200	5902062502483



Ref.	Info	Ø [mm]	Box	EAN
55H939	K40	125	5 0/200	5902062502490
55H940	K60	125	5 0/200	5902062502506
55H941	K80	125	5 0/200	5902062502513
55H942	K100	125	5 0/200	5902062502520
55H943	K120	125	5 0/200	5902062502537
55H944	K240	125	5 0/200	5902062502544
55H945	K40	150	5 0/100	5902062502551
55H946	K60	150	5 0/100	5902062502568
55H947	K80	150	5 0/100	5902062502575
55H948	K100	150	5 0/100	5902062502582
55H949	K120	150	5 0/100	5902062502599
55H950	K150	150	5 0/100	5902062502605

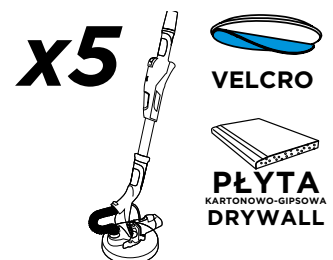
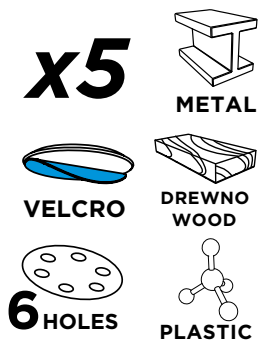



Ref.	Info	Ø [mm]	Box	EAN
55H951	K40	150	5 0/100	5902062502612
55H952	K60	150	5 0/100	5902062502629
55H953	K80	150	5 0/100	5902062502636
55H954	K100	150	5 0/100	5902062502643
55H955	K120	150	5 0/100	5902062502650
55H956	K150	150	5 0/100	5902062502667

Ref.	Info	Ø [mm]	Box	EAN
57H830	K80	225	5 0/5	5902062578303
57H832	K120	225	5 0/5	5902062578327
57H834	K180	225	5 0/5	5902062578341

POWER IN YOUR HANDS

Krażki ścierne

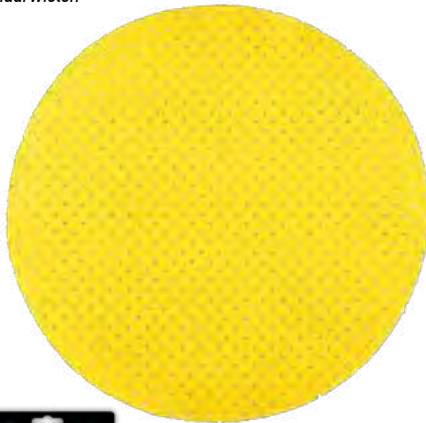
Abrasive discs / Schleifscheibe / Шлифовальные круги / Круги шлифовальни / Csiszolókorongok / Discuri abrazive / Brusné kroužky / Brúsne kotúče / Brusne plošče / Šlifavimo diskeljai / Slīpēšanas aplī / Lihvrõngad / Абразивни дискове / Brusni kolutiči / Diskovi za brušenje / Δίσκοι λείανσης / Hoja de lija circular / Dischi abrasivi / Discos abrasivos / Roulette abrasive / Schuurwielen

PLĘTA
KARTONOWO-GIPSOWA
DRYWALL

x5



VELCRO

PERFORATED

Ref.	Info	Ø [mm]			EAN
55H779	K80	225	5	0/20	5902062502674
55H780	K120	225	5	0/20	5902062502681
55H781	K180	225	5	0/20	5902062502698

Siatki ścierne

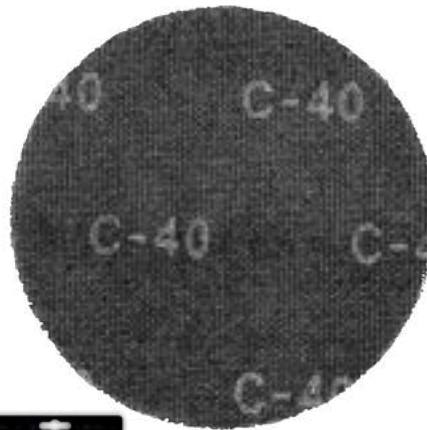
Abrasive mesh discs / Schleifgitter / Шлифовальная сетка / Сітки наждакові / Csiszolóháló / Plase abrazive / Brusné sítky / Brúsna mrežka / Brusne mreže / Šlifavimo tinkleliai / Slīpēšanas tīkli / Lihvõrk / Абразивни мрежу / Brusne mreže / Abrazivne mreže / Πλέγμα λείανσης / Mallas de lijado / Reti abrasive / Redes abrasivas / Grilles abrasives / Schuurmetten

PLĘTA
KARTONOWO-GIPSOWA
DRYWALL

x10



VELCRO

MESH

Ref.	Info	Ø [mm]			EAN
55H743	K40	225	10	0/40	5902062502704
55H744	K80	225	10	0/40	5902062502711
55H745	K120	225	10	0/40	5902062502728
55H746	K180	225	10	0/40	5902062502735

Krażki ścierne fibra

Abrasive fibre discs / Fiberschleifscheiben / Шлифовальные фибровые круги / Круги абразивни фибра / Csiszoló korongok fibra / Discuri abrazive fibre / Brusné kotoúče fibr / Vlákniťe brusne kotúče / Brusni diski fibra / Abraziviniai šlifavimo diskai / Slīpēšanas šķiedrdiski / Kiud-abrasivkettad / Абразивни фибър дискове / Fiber brusni diskovi / Brusni fiber disk / Ινώδεις δίσκοι λείανσης / Discos de fibra / Dischi abrasivi in fibra / Discos abrasivos fibra / Disques abrasifs à fibres / Schuurschijven fiber

x3

ZIRCONIUM GRIT

METAL

STAL NIERDZEWNA
STAINLESS STEEL

PLASTIC

DREWNO
WOOD

Ref.	Info	Ø [mm]			EAN
55H850	K40	125	3	0/100	5902062810755
55H851	K60	125	3	0/100	5902062810762
55H852	K80	125	3	0/100	5902062810779
55H853	K100	125	3	0/100	5902062810786
55H854	K120	125	3	0/100	5902062810793

Tarcza do fibry

Backing pad for fibre discs / Schleifteller für Fiberscheiben / Диск для фибры / Диск до фибры / Fibertárcsa / Disc pentru fibră / Kotouč na fibr / Kotúč na vlákno / Podložna plošča / Pluošto diskai / Disks fibrai / Fiibriketas / Φιβερ δισκ / Ploča za fibr / Fiber disk / Πέλα δίσκων από ινώδες υλικό / Disco para fibra / Disco di fibra / Disco para fibra / Disque fibre / Schijf voor fibra





for FIBRE DISCS

M14

Ref.	Ø [mm]		EAN
57H860	125	1/100	5902062502742

Włóknina ścierna

Abrasive cloth / Schleifstoff / Наждачное волокно / Волокно абразивне / Csiszolófilc / Tesáturá abrazivá / Brusné rouno / Brúsna vláknina / Brusno vlakno / Šlifavimo medžiaga / Slīpēšanas audekls / Lihvkiud / Абразивна тъкан / Brusna tkanina / Abrazivna tkanina / Υφασμα λείανσης / Tela de lijar / Tessuto abrasivo / Tecido abrasivo / Textile abrasif / Papieren zak

x3

METAL

DREWNO
WOOD

Ref.	Info	Ø [mm]			EAN
55H855	K40	125	3	0/100	5902062810809
55H856	K60	125	3	0/100	5902062810816
55H857	K80	125	3	0/100	5902062810823
55H858	K100	125	3	0/100	5902062810830
55H859	K120	125	3	0/100	5902062810847



METAL

Ref.	Ø [mm]		EAN
55H992	125 x 22.2	5/100	5902062503473

Tarcza szlifierska z rzepem

Rubber disc / Schleifscheibe mit Klettverschluss / Круг шлифовальный с липучкой / Круг шлифовальный на липучци / Rugalmas csiszoló tárcs / Disc de sauciu / Leštící kotouč se suchým zipem / Gumový disk stopkový pevný / Brusilna plošča z velcro papirjem / Guminis šlifavimo diskas / Gumijas pamatne slīpdiskam / Kummiketaset / Диск гугмен / Disk gumeni za bušilicu / Gumeni disk / Δίσκος λείανσης / Disco elástico con velcro / Disco di gomma / Disco p. esmerilhar / Meule abrasive à adhésif Velcro / Slijpschijf met velcroband



Ref.	Ø [mm]	📦	EAN
55H928	125	0/50	5902062502803
55H929	150	0/50	5902062502810



Ref.	Ø [mm]	📦	EAN
55H825	125	0/50	5902062502773
55H826	150	0/50	5902062502780
55H827	125	0/50	5902062502797



Ref.	Ø [mm]	📦	EAN
55H823	125	0/50	5902062502759



Ref.	Ø [mm]	📦	EAN
55H824	125	0/50	5902062502766

Gąbka ścierna

Abrasive sponge / Scheuerschwamm / Абразивная губка / Губка наждачна / Csiszolószivacs / Burete abraziv / Brusná houba / Brúsna špongja / Brusna gobica / Abrazivné kempině / Slīpēšanas sūklis / Lihvimiskāsn / Абразивна гъба / Brusna spužva / Abrazivni sunder / Λειαντικό αφουγγάρι / Esponja abrasiva / Spugna abrasiva / Esponja abrasiva / Éponge abrasive / Schurende spons /

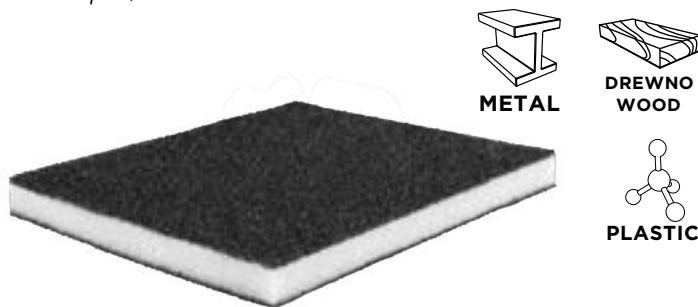

Ref.	Info	W [mm]	📦	EAN
55H912	K60	120 x 95 x 10	0/250	5902062888358
55H913	K100	120 x 95 x 10	0/250	5902062888365
55H914	K180	120 x 95 x 10	0/250	5902062888372

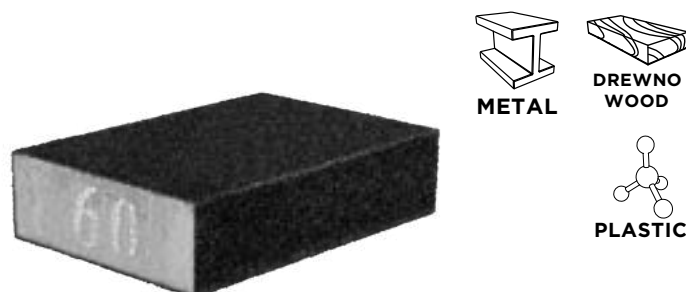

Ref.	Info	W [mm]	📦	EAN
55H915	K60	70 x 25 x 100	0/250	5902062888389
55H916	K80	70 x 25 x 100	0/250	5902062888396
55H917	K100	70 x 25 x 100	0/250	5902062888402
55H918	K120	70 x 25 x 100	0/250	5902062888419
55H919	K150	70 x 25 x 100	0/250	5902062888426
55H920	K180	70 x 25 x 100	0/250	5902062888433
55H921	K240	70 x 25 x 100	0/250	5902062888440

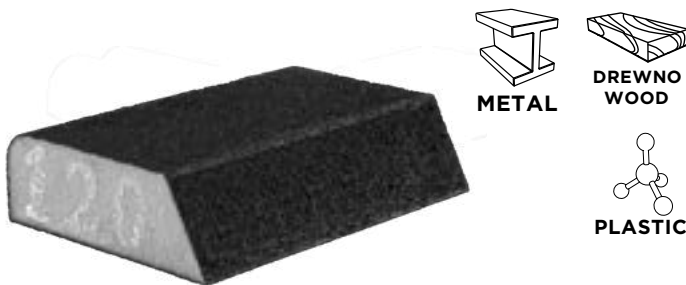

Ref.	Info	W [mm]	📦	EAN
55H925	K80	98 x 25 x 68	0/200	5902062888488
55H926	K120	98 x 25 x 68	0/200	5902062888495
55H927	K180	98 x 25 x 68	0/200	5902062888501



Ref.	Info	W [mm]	📦	EAN
55H922	K80	125 x 25 x 90	0/200	5902062888457
55H923	K120	125 x 25 x 90	0/200	5902062888464
55H924	K180	125 x 25 x 90	0/200	5902062888471

Papier ścierny

Sanding paper / Schleifpapier / Бумага наждачная / Папір наждачний / Csizolópapír / Hírtie zsmirghel ce se încheie singură / Brusný papír / Papier brúsný-rolka / Brusni papir / Šlifavimo papirius / Smilšpapīrs / Liivaraber / Шкурка руло / Brusni papir u roli / Brusni papir / Λειαντικό ύφασμα / Lija / Carta abrasiva / Folha de lixa / Papier abrasif / Schuurpapier



VELCRO

x5



x5



METAL



DREWNO
WOOD



PLASTIC

Ref.	Info	W [mm]			EAN
55H720	K40	115x230	5	0/100	5902062810472
55H721	K60	115x230	5	0/100	5902062810489
55H722	K80	115x230	5	0/100	5902062810496
55H723	K100	115x230	5	0/100	5902062810502
55H724	K120	115x230	5	0/100	5902062810519
55H725	K180	115x230	5	0/100	5902062810526
55H726	K240	115x230	5	0/100	5902062810533
55H736	K40	93x185	5	0/100	5902062810618
55H737	K60	93x185	5	0/100	5902062810625
55H738	K80	93x185	5	0/100	5902062810632
55H739	K100	93x185	5	0/100	5902062810649
55H740	K120	93x185	5	0/100	5902062810656
55H741	K180	93x185	5	0/100	5902062810663
55H742	K240	93x185	5	0/100	5902062810670



METAL



DREWNO
WOOD



PLASTIC

Ref.	Info	W [mm]			EAN
55H728	K40	115x280	5	0/100	5902062810540
55H729	K60	115x280	5	0/100	5902062810557
55H730	K80	115x280	5	0/200	5902062810564
55H731	K100	115x280	5	0/200	5902062810571
55H732	K120	115x280	5	0/200	5902062810588
55H733	K180	115x280	5	0/200	5902062810595
55H734	K240	115x280	5	0/200	5902062810601
55H747	K40	93x230	5	0/200	5902062810687
55H748	K60	93x230	5	0/200	5902062810694
55H749	K80	93x230	5	0/200	5902062810700
55H750	K100	93x230	5	0/200	5902062810717
55H751	K120	93x230	5	0/200	5902062810724
55H752	K180	93x230	5	0/200	5902062810731
55H753	K240	93x230	5	0/200	5902062810748



x5



METAL



DREWNO
WOOD



PLASTIC

Ref.	Info	W [mm]			EAN
55H957	K40	93x230	5	0/100	5902062502889
55H958	K60	93x230	5	0/100	5902062502896
55H959	K80	93x230	5	0/100	5902062502902
55H960	K100	93x230	5	0/100	5902062502919
55H961	K120	93x230	5	0/100	5902062502926
55H962	K150	93x230	5	0/100	5902062502933
55H963	K180	93x230	5	0/100	5902062502940
55H964	K220	93x230	5	0/100	5902062502957
55H965	K240	93x230	5	0/100	5902062502964



METAL



DREWNO
WOOD



PLASTIC

Ref.	Info	W [mm]		EAN
55H884	K36	280x230	0/500	5902062888082
55H885	K40	280x230	0/500	5902062888099
55H886	K60	280x230	0/500	5902062888105
55H887	K80	280x230	0/500	5902062888112
55H888	K100	280x230	0/500	5902062888129
55H889	K120	280x230	0/1000	5902062888136
55H890	K150	280x230	0/1000	5902062888143
55H891	K180	280x230	0/1000	5902062888150
55H892	K200	280x230	0/1000	5902062888167
55H893	K220	280x230	0/1000	5902062888174
55H894	K240	280x230	0/1000	5902062888181



WET
SANDING

Ref.	Info	W [mm]		EAN
55H896	K60	280x230	0/500	5902062888198
55H897	K80	280x230	0/500	5902062888204
55H898	K100	280x230	0/500	5902062888211
55H899	K120	280x230	0/500	5902062888228
55H900	K150	280x230	0/1000	5902062888235
55H901	K180	280x230	0/1000	5902062888242
55H902	K220	280x230	0/1000	5902062888259
55H903	K240	280x230	0/1000	5902062888266
55H904	K320	280x230	0/1000	5902062888273
55H905	K600	280x230	0/1000	5902062888280
55H906	K800	280x230	0/1000	5902062888297
55H907	K1000	280x230	0/1000	5902062888303
55H908	K1200	280x230	0/1000	5902062888310
55H909	K1500	280x230	0/1000	5902062888327
55H910	K2000	280x230	0/1000	5902062888334
55H911	K2500	280x230	0/1000	5902062888341

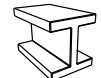
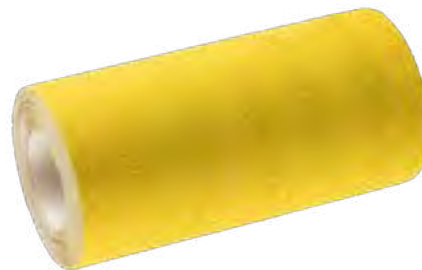

METAL



DREWNO
WOOD

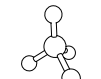

PLASTIC



PLYTA
KARTONOWO-GIPSOWA
DRYWALL

Ref.	Info	W [mm]	L [m]		EAN
55H860	K60	115	2.5	0/100	5902062810854
55H861	K80	115	2.5	0/100	5902062810861
55H862	K100	115	2.5	0/100	5902062810878
55H863	K120	115	2.5	0/100	5902062810885
55H864	K150	115	2.5	0/100	5902062810892
55H865	K180	115	2.5	0/100	5902062810908
55H866	K220	115	2.5	0/100	5902062810915

Papier ścierny

Sanding paper / Schleifpapier / Бумага наждачная / Папір наждачний / Csiszolópapír / Hirtie šmirghel ce se încheie singură / Brusný papír / Papier brúsny-rolka / Brusni papir / Šlifavimo papierius / Smilšpapīrs / Liivapaber / Шкурка руло / Brusni papir u roli / Brusni papir / Λειαντική ύφανση / Lija / Carta abrasiva / Folha de lixa / Papier abrasif / Schuurpapier

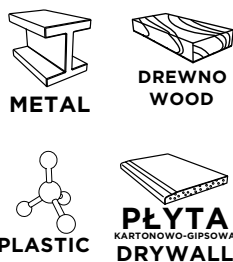

Ref.	Info	W [mm]	L [m]		EAN
55H972	K40	115	50	0/4	5902062503138
55H973	K60	115	50	0/4	5902062503145
55H974	K80	115	50	0/4	5902062503152
55H975	K100	115	50	0/4	5902062503169
55H976	K120	115	50	0/4	5902062503176
55H977	K150	115	50	0/4	5902062503183
55H978	K180	115	50	0/4	5902062503190
55H979	K220	115	50	0/4	5902062503206

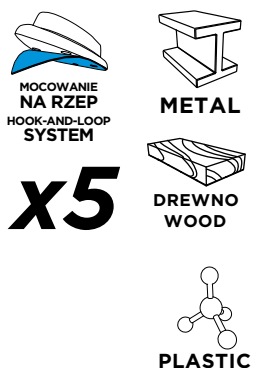

Ref.	Info	W [mm]			EAN
55H763	K40	93x93	5	0/200	5902062502827
55H764	K60	93x93	5	0/200	5902062502834
55H765	K80	93x93	5	0/200	5902062502841
55H766	K100	93x93	5	0/200	5902062502858
55H767	K120	93x93	5	0/200	5902062502865
55H768	K240	93x93	5	0/200	5902062502872

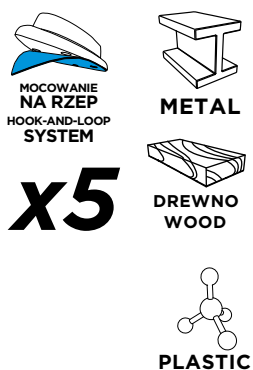
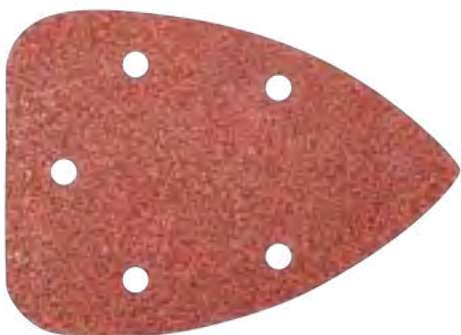

Ref.	Info	W [mm]			EAN
57H820	K40	97x140	5	0/30	5902062578204
57H822	K60	97x140	5	0/30	5902062578228
57H824	K80	97x140	5	0/30	5902062578242
57H826	K120	97x140	5	0/30	5902062578266
57H828	K150	97x140	5	0/30	5902062578280

Płótna ściernie

Abrasive cloths / Schleifleinen / Шлифовальные полотна / Платна наждакові / Csiszolóvászonok / Pánze abrazive / Brusná plátna / Brusne plátna / Brusna platna / Šlifavimo popieriai / Slīpēšanas audēkls / Lihvriie / Абразивни платна / Brusna platna / Abrazivna platna / Χαριτιά λείανσης / Lijas de tela / Tessuti abrasivi / Tecidos abrasivos / Toiles abrasives / Schuurtextielen



Ref.	Info	W [mm]		EAN
55H873	K36	280x230	0/250	5902062810984
55H874	K40	280x230	0/250	5902062810991
55H875	K60	280x230	0/250	5902062888006
55H876	K80	280x230	0/500	5902062888013
55H877	K100	280x230	0/500	5902062888020
55H878	K120	280x230	0/500	5902062888037
55H879	K150	280x230	0/500	5902062888044
55H880	K180	280x230	0/500	5902062888051
55H881	K220	280x230	0/500	5902062888068
55H882	K240	280x230	0/500	5902062888075

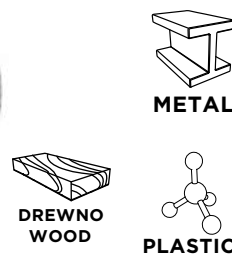

Ref.	Info	W [mm]	L [m]		EAN
55H867	K40	115	2.5	0/70	5902062810922
55H868	K60	115	2.5	0/70	5902062810939
55H869	K80	115	2.5	0/100	5902062810946
55H870	K100	115	2.5	0/100	5902062810953
55H871	K120	115	2.5	0/100	5902062810960
55H872	K150	115	2.5	0/100	5902062810977



Ref.	Info	W [mm]	L [m]		EAN
55H966	K40	150	50	0/2	5902062503077
55H967	K60	150	50	0/2	5902062503084
55H968	K80	150	50	0/2	5902062503091
55H969	K100	150	50	0/2	5902062503107
55H970	K120	150	50	0/2	5902062503114
55H971	K150	150	50	0/2	5902062503121

Pas bezkońcowy

Sanding belt / Riemen endlos / Лента абразивная бесконечная / Стричка наждачна безкінечна / Csiszolóvászón végtelenített / Bandă de șlefuit / Pískový brusný pás / Brúsný pás / Neskončni trak / Popierině šľifavito juosta / Šľifpenta / Lihvimislint / Шкурка / Brusna traka / Brusna traka / Λειαντική ταινία / Banda lijadora / Carta abrasiva / Cinto sem fim / Ceinture sans fin / Schuurbandslijper



Ref.	Info	W [mm]	L [mm]		EAN
55H787	K40	75	457	0/100	5902062502971
55H788	K60	75	457	0/100	5902062502988
55H789	K80	75	457	0/100	5902062502995
55H790	K100	75	457	0/100	5902062503008
55H791	K120	75	457	0/100	5902062503015
55H797	K40	75	533	0/100	5902062503022
55H798	K60	75	533	0/100	5902062503039
55H799	K80	75	533	0/100	5902062503046
55H800	K100	75	533	0/100	5902062503053
55H801	K120	75	533	0/100	5902062503060

Ściernica trzpieniowa, listkowa

Sanding label cylinder / Blattschleifstift / Крыг шліфовальний лепестковий / Крыг абразивний лепестковий / Csapos csiszolókorong / Cilindru de șlefuit / Brusný kotouč listkový s trnem / Brúsný kotúč listkový so stopkou / Lamelni brus / Šľifavito padas / Šľiflapu disks / Lihvsilinder / Шкурка вентрало / Lamelni brus sa osovinom / Lamelni brus sa osovinom / Λειαντικός κύλινδρος / Abanico lijador / Mola a mandrino, fogli / Roda de esmeril / Meule abrasive à tige, à lamelles / Blad zandsteen



Ref.	Info	W [mm]		EAN
55H754	K40	40x20	1/150	5902062503213
55H755	K60	40x20	1/150	5902062503220
55H756	K80	40x20	1/150	5902062503237
55H757	K40	60x30	1/100	5902062503244
55H758	K60	60x30	1/100	5902062503251
55H759	K80	60x30	1/100	5902062503268
55H760	K40	80x30	1/100	5902062503275
55H761	K60	80x30	1/60	5902062503282
55H762	K80	80x30	1/60	5902062503299

Brzeszczot do pilarki szablastej

Blade for reciprocating saw / Sägeblatt für Säbelsäge / Пильное полотно для сабельной пилы / Полотно до сабельної пилки / Orzfűrész fűrészlap / Pânză fierăstrău sabie / Pilový list pro šavlovou pilu / Čepeľ šablovej pily / List za sabljasto žago / Pjūkliukas tiesiniam pjūklui / Zobenzāga asmenis / Saabelsae tera / Ножовка за саблен трион / List za sabljastu pilu / Sečivo za kružnu testeru / Приονόλαμα για αναθόσεια / Hoja de sierra para sierra de sable / Lama per sega a gattuccio / Lâmina para serra de sabre / Lame de scie sabre / Mes voor sabelzaag

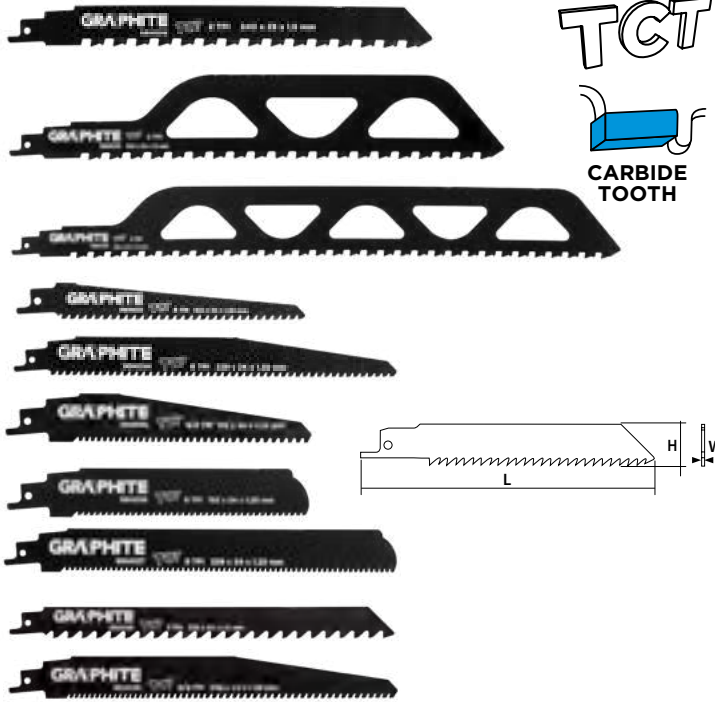

Ref.	TPI	L [mm]	H [mm]	W [mm]		EAN
56H030	2	240	23	1.5	25/100	5902062506511
56H031	2	305	50	1.5	25/100	5902062506528
56H032	2	455	50	1.5	25/100	5902062506535
56H033	6	152	19	1.25	25/100	5902062506542
56H034	6	228	24	1.25	25/100	5902062506566
56H035	8/6	152	24	1.25	25/100	5902062506573
56H036	8	152	24	1.25	25/100	5902062506580
56H037	8	228	24	1.25	25/100	5902062506597
56H038	3	228	22	1.5	25/100	5902062506603
56H039	8	228	24	1.25	25/100	5902062506610

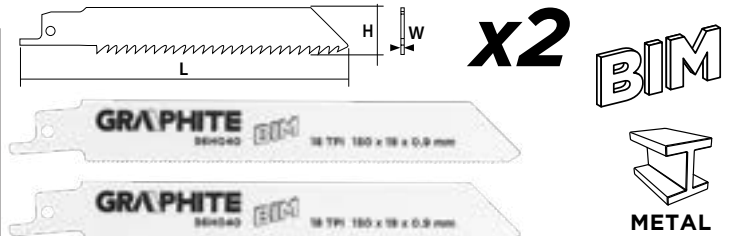

Ref.	TPI	L [mm]	H [mm]	W [mm]		EAN
56H040	18	150	19	0.8	25/100	5902062506627

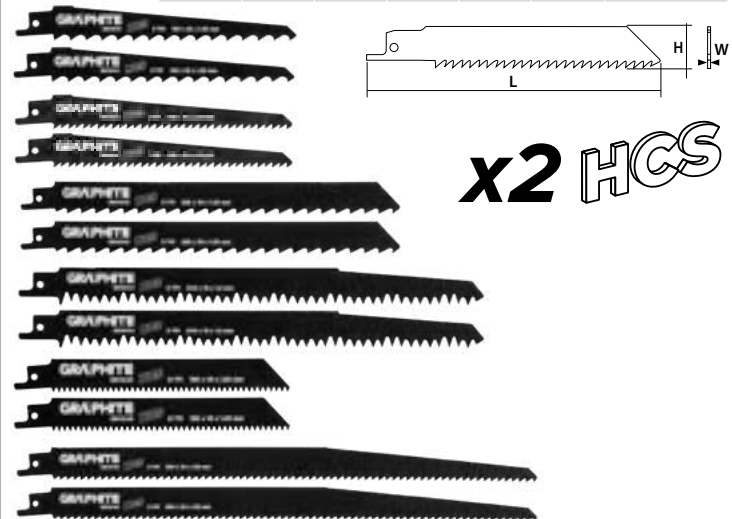

Ref.	TPI	L [mm]	H [mm]	W [mm]		EAN
56H041	3	150	19	1.25	25/100	5902062506634
56H042	6	150	19	1.25	25/100	5902062506641
56H043	3	225	19	1.25	25/100	5902062506658
56H044	5	240	19	1.5	25/100	5902062506665
56H045	6	150	19	1.25	25/100	5902062506672
56H046	6	300	19	1.25	25/100	5902062506689

Brzeczot do pilarki szablastej

Blade for reciprocating saw / Sägeblatt für Säbelsäge / Пильное полотно для сабельной пилы / Полотно до шабельной пилки / Orffűrész fűrészlap / Pánzř fiřerřtrřu sabie / Pilovř list pro řavlovou pilu / Ćepel řablovej pily / List za sabljasto řago / Pjřkliukas tiesiniat pjřkliui / Zobenzřga asmenis / Saabelsaē tera / Hořsovka za sablen trion / List za sabljastu pilu / Seĉivo za kruřnu testeru / Prionřlameřa / Hoja de sierra para sierra de sable / Lame per sega a gattuccio / Lřmina para serra de sable / Lame de scie sable / Mes voor sabelzaag

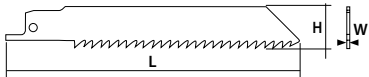

HCS

x3



Ref.	TPI	L [mm]	H [mm]	W [mm]	Icon	EAN
56H047	6/6-10/5	150/200/240	19	1.25/1.25/1.5	5/20	5902062506696

x3 BIM



METAL

Ref.	TPI	L [mm]	H [mm]	W [mm]	Icon	EAN
56H048	24/8-14/14	150/150/225	19	0.9	5/20	5902062506702

x10 BIM

HCS

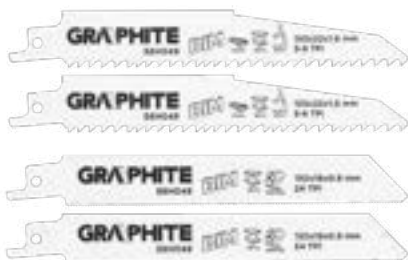

METAL

PLASTIC

DREWNO WOOD



Ref.	Icon	EAN
56H049	5/20	5902062506719

Brzeczoty bagnetowe

Sabre saw blade / Bajonett-Sģgenblatt / Полотна / Полотна пильні з точним зубом / Orffűrészlap / Panze bajoneta / Meĉovř pilovř listy / Meĉovř pilovř listy / Bajonetni řagni listi / Bimetaliniai pjřkliukai / Asmens zobenzřģim / Třřk-saelehed / Сменяеми ленти за трїон / Bajonet listovi pile / Ořtrice nořa / Prionřlameř / Hojas de sable / Lame per sega a gattuccio / Lřminas / Lames de scie řa bajonnette / Sabel mesbladen

STAL NIEROZEWNA STAINLESS STEEL

METAL

DREWNO WOOD

CU

AL

PLASTIC



x2

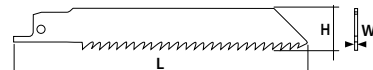

Ref.	L [mm]	H [mm]	W [mm]	TPI / mm	Icon 1	Icon 2	EAN
57H947	250	20	0.9	10 / 2.5	2	0/100	5902062579478
57H948	300	20	0.9	14 / 1.8	2	0/1	5902062579485
57H950	150	20	0.9	10-14 / 2.5-1.8	2	0/150	5902062579508
57H951	150	20	0.9	14 / 1.8	2	0/1	5902062579515
57H952	225	20	0.9	14 / 1.8	2	0/150	5902062579522
57H953	225	20	0.9	18 / 1.4	2	0/100	5902062579539
57H954	225	20	0.9	6 / 4.0	2	0/1	5902062579546

Brzeczoty do wyrzynarki

Jigsaw blades / Sģgeblatter fřr Schweifsģge / Полотна для лобзика / Полотно пильне до лобзика / Dekopřfűrřsz lap / Pģnze de ferřstrřu de decupat / Pilovř listy pro listovou pilu / Listy do priamociarej přlky / Listi za vboďno řago / Pjřkliukai siaurapjřkliui / Finierzřga asmeņi / Tikksae terad / Листове за ажурна дървообработваща машина / Listovi pile za ubodnu pilu / Seĉiva za ruĉnu testeru / Prionřlameř sģřas / Hojas para sierra de calar / Lame per seghetto alternativo / Lřminas p. Mģquina de entalhar / Lames de scie pour scie sauteuse / Mesbladen voor decoupeerzaag

x2

BLADE TYPE T

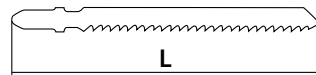

Ref.	L [mm]	TPI [mm]	Icon 1	Icon 2	Icon 3	Icon 4	Icon 5	Icon 6	EAN
57H759	100	8 / 3.0	x	x				2	HCS 0/20 5902062577597
57H760	100	10 / 2.5	x	x				2	HCS 10/400 5902062577603
57H761	100	6 / 4.0	x	x				2	HCS 10/400 5902062577610
57H762	100	6 / 4.0	x					2	HCS 10/20 5902062577627
57H763	100	6 / 4.0	x					2	HCS 10/20 5902062577634
57H764	100	8 / 3.0	x					2	HCS 10/400 5902062577641
57H765	75	12 / 2.0	x	x				2	HCS 10/400 5902062577658
57H766	75	13 / 2.0	x	x				2	HCS 10/20 5902062577665
57H767	75	21 / 1.2					x	2	HSS 10/20 5902062577672
57H768	75	21 / 1.2					x	2	BIM 10/200 5902062577689
57H769	100	10 / 2.5	x					2	HCS 10/20 5902062577696
57H770	100	12 / 2.0	x					2	HCS 20/20 5902062577702
57H771	130	10 / 14	x			x	x	2	BIM 10/20 5902062577719

Brzeczoty do wyrzynarki

Jigsaw blades / Sägeblätter für Schweißsäge / Полотна для лобзика / Полотно пильне до лобзика / Dekopírfúrész lap / Pânze de ferăstrău de decupat / Pilové listy pro listovou pilu / Listy do priamočiarej pítky / Listi za vboodno žago / Pjūkliukai siaurapjūkliui / Finierzāģa asmeņi / Tikksae terad / Листове за ажурна дървообработваща машина / Listovi pile za ubodnu pilu / Sečiva za ručnu testeru / Приνóλαμες σέγας / Hojas para sierra de calar / Lame per seghetto alternativo / Láminas p. Máquina de entalhar / Lames de scie pour scie sauteuse / Mesbladen voor decoupeerzaag



GRAPHITE HCS

BLADE TYPE T

x25

Ref.	L [mm]	TPI [mm]								EAN		
57H760-25	100	10/2.5	x	x					25	HCS	10/50	5902062253231



GRAPHITE HCS

BLADE TYPE T

x10

Ref.	L [mm]	TPI [mm]								EAN	
57H754	100	6/4.0	x	x					HCS	10/100	5902062577542
	100	6/4.0	x					HCS			
	75	12/2.0	x	x				HCS			
	75	21/1.2			x			HSS			
	100	10/2.5	x					HCS			
	75	21/1.2			x	x		BIM			



GRAPHITE HCS

BLADE TYPE T

x10

Ref.	L [mm]	TPI [mm]								EAN	
57H755	100	6/4.0	x	x					HCS	0/40	5902062577559
	100	6/4.0	x					HCS			
	75	12/2.0	x	x				HCS			
	75	21/1.2			x			HSS			
	100	8/3.0	x	x				HCS			
	100	10/2.5	x					HCS			
75	21/1.2			x	x		BIM				

Otwornica

Compass saw / Lochsäge / Ножовка / Фреза / Lyukfúrész / Ferăstrău pentru găuri / Dėrovka / Dierovacica pila / Luknjariča / Vienarankis pjūklas / Rokzāģis / Augusaag / Тесен трион / Nareznica / Ručna testera za pravljenje otvora / Приónи / Sierra de corona / Segga a tazza a doppio metallo / Serra para recorte / Scie à guichet / Gatenknipper

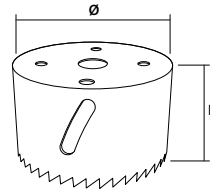

Ø
H

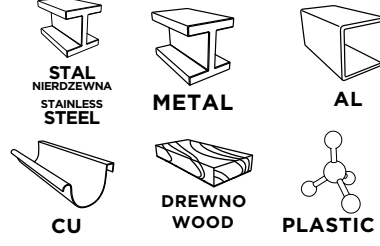

STAL NIERDZEWNA
STAINLESS
STEEL

METAL

AL

DREWNO
WOOD

PLASTIC

CU



GRAPHITE



Ref.	Ø [mm]	H [mm]	MAX. RPM		MAX. RPM		MAX. RPM		MAX. RPM		EAN
57H900	16	38	3000	2250	550	275	730	825	8/96	5902062579003	
57H902	19	38	3000	2250	460	230	600	690	8/96	5902062579027	
57H904	20	38	3000	2250	425	210	560	635	8/96	5902062579041	
57H901	21	38	3000	2250	425	210	560	635	6/72	5902062579010	
57H906	22	38	3000	2250	390	195	520	585	8/96	5902062579065	
57H908	25	38	2700	2000	350	175	470	525	6/72	5902062579089	
57H903	27	38	2700	2000	350	175	470	525	8/96	5902062579034	
57H910	29	38	2700	2000	300	150	400	450	6/72	5902062579102	
57H912	32	38	2400	1800	275	140	380	410	8/96	5902062579126	
57H914	35	38	2400	1800	250	125	330	375	6/24	5902062579140	
57H916	38	38	2400	1800	240	120	315	360	6/72	5902062579164	
57H918	40	38	2100	1500	220	110	290	330	6/24	5902062579188	
57H905	44	38	2100	1500	220	110	290	330	6/72	5902062579058	
57H920	46	38	2100	1500	195	95	260	295	6/24	5902062579201	
57H922	51	38	2000	1500	170	85	230	255	6/72	5902062579225	
57H907	54	38	2000	1500	170	85	230	255	6/24	5902062579072	
57H924	57	38	2000	1500	150	75	200	225	6/72	5902062579249	
57H909	60	38	1900	1500	150	75	200	225	6/24	5902062579096	
57H926	64	38	1800	1350	135	65	180	205	6/72	5902062579263	
57H928	67	38	1800	1350	125	60	160	185	6/24	5902062579287	
57H911	70	38	1800	1350	125	60	160	185	6/72	5902062579119	
57H930	73	38	1800	1350	120	60	160	180	6/72	5902062579300	
57H932	83	38	1500	1100	105	40	140	155	6/72	5902062579324	
57H913	86	38	1500	1100	105	40	140	155	6/24	5902062579133	
57H915	92	38	1200	1100	105	40	140	155	6/24	5902062579157	
57H934	95	38	1200	900	95	40	120	140	6/24	5902062579348	
57H936	105	38	1000	750	80	40	110	120	6/24	5902062579362	
57H917	114	38	1 000	750	80	40	110	120	6/24	5902062579171	
57H919	140	38	800	700	70	30	100	110	6/24	5902062579195	

Adapter do otwornic

Adapter for hollow annular drill heads / Adapter für Lochsäge / Переходник для коронок / Адаптер перехідний до фрез / Adapter lyukfúrészhez / Adaptor pentru sarete găurire cu coroana / Adaptér pro děrovku / Adaptér do dierovacích pil / Adapter za luknjariče / Jungtis grėžimo karūnai / Adapteris kroonurbim / Adapter kroonpuuridele / Адаптер за сараєдна / Adapter za nareznice / Adapter za ručne testere / Αντάπτορας για πομπόρριπανα / Adattatore para sierras de corona / Adattatore per segga a tazza / Adattador do Serras para recorte / Adaptateur de scie a guichet / Adapter voor gatenknippers

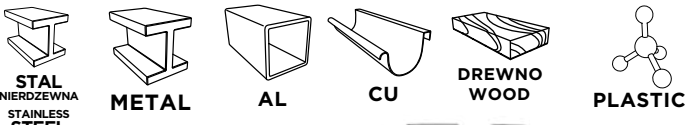

STAL NIERDZEWNA
STAINLESS
STEEL

METAL

AL

CU

DREWNO
WOOD

PLASTIC



GRAPHITE



Ref.	Ø [mm]	Info		EAN
57H938	14-30	adapter	25/50	5902062579386
57H940	>30	adapter	25/50	5902062579409
57H944	6,35	wiertło	25/50	5902062579447

Uchwyt magnetyczny

Magnetic holder / Magnetaufnahme / Держатель магнитный / Патрон магнітний / Toldószár behajt / Suport magnetic / Magnetický držák / Magnetické skľučovadlo / Magnetno vpenjalo / Magnetinis griebtuvas / Magnētiskais turētājs / Magnetpadrun / Магнітен държач / Magnetna hvataljka / Magnetna drška / Υποδοχή μαγνητική / Mandril de sujeción magnético / Porta inserti con giunto sferico / Suporte magnético / Manche magnétique / Magnetisch houder

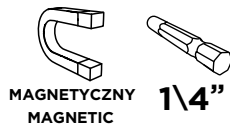
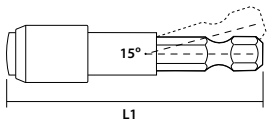

MAGNETYCZNY
MAGNETIC 1/4"



Ref.	L [mm]	Box	EAN
55H995	65	75/150	5902062689955
57H995	60	50/100	5902062579959

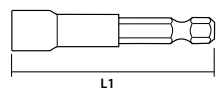

IMPACT PROOF
MAGNETYCZNY
MAGNETIC



Ref.	L [mm]	Box	EAN
56H554	60	50/100	5902062504777

Adapter

Adapter / Adapter / Адаптер / Перехідник / Kőzdarab, adapter / Adaptor / Adaptér / Adaptér / Adapter / Jungtis / Adapteris / Adapter / Адаптер / Adapter / Adapter / Αντάπτορας / Adaptador / Adattatore / Adaptador / Adaptateur / Adapter



IMPACT PROOF 1/4"



Ref.	L [mm]	Box	EAN
56H555	1/4" HEX -> 1/4" [O]	50/100	5902062504784
56H556	1/4" HEX -> 1/2" [O]	50/100	5902062504791

Nasadki magnetyczne

Magnetic sockets / Aufsätze magnetisch / Насадки магнитные / Патрони магнітні / Csavarbehajtó / Brätarå magnetica / Magnetické nástavce / Magnetické nástavce / Magnetni nasadni ključ / Magnetiniai antgaliai / Magnētiskie uzgali / Magnetotsak / Магнітні насадки / Magnetski nasadni nastavci / Magnetne kapice / Μαγνητική υποδοχή / Vaso magnético / Bussola esagonale / Bocais magnéticos / Douilles magnétiques / Magnetische doppen

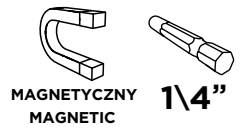
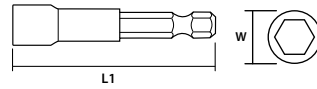

MAGNETYCZNY
MAGNETIC 1/4"



Ref.	L [mm]	W [mm]	Box	EAN
57H991	65	6	25/100	5902062579911
57H992	65	8	60/360	5902062579928
57H993	65	10	60/360	5902062579935
57H994	65	13	40/240	5902062579942

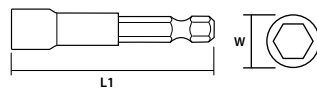

IMPACT PROOF
MAGNETYCZNY
MAGNETIC



Ref.	L [mm]	W [mm]	Box	EAN
56H550	65	6	50/100	5902062504739
56H551	65	8	50/100	5902062504746
56H552	65	10	50/100	5902062504753
56H553	65	13	50/100	5902062504760

Końcówki wkrętakowe

Driver bits / Einsätze für Schraubendreher / Насадки / Наконечники викрутки / Csavarhúzó bitek / Set biti / Šroubovákové nástavce / Skrutkovacie nástavce / Nastavci za izvijače / Atsuktuvo antgaliai / Skrvngrieža uzgali / Kruvikeeraajatsakud / Накраїнуци за отвёртка / Nastavci za odvijač / Κατασβίδομυτες / Puntas destornilladoras / Inserti per avvitare / Ponteiros Chave de fenda / Embouts de tournevis / Schroevendraaiereinstukken

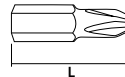

1/4"



Ref.	Info	L [mm]	Box	Box	EAN
57H960	PH1	25	2	25/250	5902062579607
57H961	PH2	25	2	60/1080	5902062579614
57H962	PH3	25	2	60/1080	5902062579621
57H963	PZ1	25	2	25/250	5902062579638
57H964	PZ2	25	2	60/1080	5902062579645
57H965	PZ3	25	2	60/1080	5902062579652
57H966	HEX 2.5	25	2	10/250	5902062579669
57H968	HEX 4	25	2	60/1080	5902062579683
57H971	TX10	25	2	25/250	5902062579713
57H972	TX15	25	2	25/250	5902062579720
57H973	TX20	25	2	60/1080	5902062579737
57H974	TX25	25	2	25/250	5902062579744
57H975	TX27	25	2	25/250	5902062579751
57H976	TX30	25	2	25/250	5902062579768
57H977	TX40	25	2	25/200	5902062579775

Końcówki wkrętakowe

Driver bits / Einsätze für Schraubendreher / Насадки / Наконечники викрутки / Csavarhúzó bitek / Set bitů / Šroubovákové nástavce / Skrutkovacie nástavce / Nastavki za izvijače / Atsuktuvo antgaliai / Skrivgrieta uzgaļi / Kruvikeeraotsakud / Накраўніцу за отвёртка / Nastavci za odvijač / Nastavci za odvijač / Καταβιδόµυτες / Puntas destornilladoras / Inserti per avvitare / Ponteiros Chave de fenda / Embouts de tournevis / Schroevendraaiereinstukken

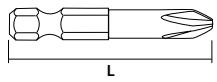

S2
TiN

1/4"



Ref.	Info	L [mm]			EAN
57H978	PH1	50	1	25/250	5902062579782
57H979	PH2	50	1	60/720	5902062579799
57H981	PZ1	50	1	25/250	5902062579812
57H982	PZ2	50	1	25/250	5902062579829
57H983	PZ3	50	1	25/250	5902062579836
57H986	TX20	50	1	10/250	5902062579867
57H987	TX25	50	1	10/250	5902062579874
57H989	TX30	50	1	25/250	5902062579898
57H990	TX40	50	1	25/250	5902062579904

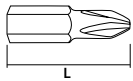

S2

1/4"



Ref.	Info	L [mm]			EAN
57H955	PH2	25	20	50/100	5902062579553
57H956	PZ2	25	20	50/100	5902062579560
57H958	PH2	50	10	50/100	5902062579584
57H959	PZ2	50	10	50/100	5902062579591

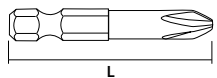

1/4"



Ref.	Info	L [mm]			EAN
55H996	PH2	150	1/12		5902062689962

Bity udarowe

Impact bits / Schlag-Bits / Ударные вставки / Бити ударни / Ütvecsavarozó bitek / Bit de impact / Úderové bity / Nárazové bity / Udarni biti / Smūginiai antgaliai / Triecienuzgaļi / Löökmeislid / Ударни бумоое / Udarni bitovi / Udarni bitovi / Κρουστικές µύτες / Bits de impacto / Inserti a percussione / Pontas de percussão / Embouts à choc / Slagbits

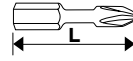

x2

S2

PH

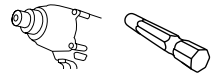

IMPACT PROOF

1/4"

Ref.	Info	L [mm]			EAN
56H500	PH1	25	2	50/100	5902062504364
56H501	PH2	25	2	50/100	5902062504371
56H502	PH3	25	2	50/100	5902062504388

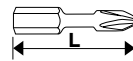

x2

S2

PZ

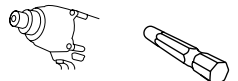

IMPACT PROOF

1/4"

Ref.	Info	L [mm]			EAN
56H503	PZ1	25	2	50/100	5902062504395
56H504	PZ2	25	2	50/100	5902062504401
56H505	PZ3	25	2	50/100	5902062504418
56H506	PZ4	25	2	50/100	5902062504425



x2

S2

HEX

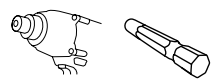

IMPACT PROOF

1/4"

Ref.	Info	L [mm]			EAN
56H507	HEX4	25	2	50/100	5902062504333
56H508	HEX5	25	2	50/100	5902062504340
56H509	HEX6	25	2	50/100	5902062504357

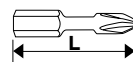

x2

S2

SL

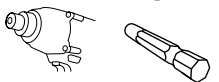

IMPACT PROOF

1/4"

Ref.	Info	L [mm]			EAN
56H510	SL5.5	25	2	50/100	5902062504432
56H511	SL6.5	25	2	50/100	5902062504449

Bity udarowe

Impact bits / Schlag-Bits / Ударные вставки / Биту ударні / Үтвєсарарозó бітєк / Bit de impact / Үдеровє біты / Nárarovє біты / Udarni biti / Smūginiai antgaliai / Triecienuzgaļi / Löökmeislid / Ударни бітовє / Udarni bitovi / Udarni bitovi / Κρουστικєς μύτєς / Bits de impacto / Inserti a percussione / Pontas de percussão / Embouts à choc / Slagbits

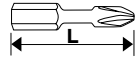

x2

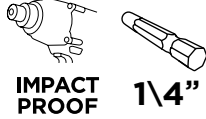

Ref.	Info	L [mm]	▢	▣	EAN
56H512	TX15	25	2	50/100	5902062504456
56H513	TX20	25	2	50/100	5902062504463
56H514	TX25	25	2	50/100	5902062504470
56H515	TX27	25	2	50/100	5902062504494
56H516	TX30	25	2	50/100	5902062504500
56H517	TX40	25	2	50/100	5902062504517



x3

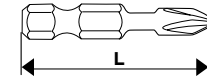
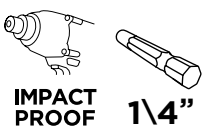

Ref.	Info	L [mm]	▢	▣	EAN
56H543	PH1/PH2/PH3	50	3	50/100	5902062504722



x2

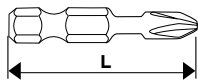

Ref.	Info	L [mm]	▢	▣	EAN
56H518	PH1	50	2	50/100	5902062504524
56H519	PH2	50	2	50/100	5902062504531
56H520	PH3	50	2	50/100	5902062504548



x3

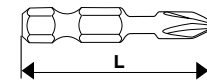
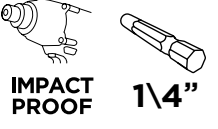

Ref.	Info	L [mm]	▢	▣	EAN
56H542	PZ1/PZ2/PZ3	50	3	50/100	5902062504715



x2

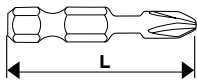
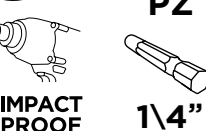

Ref.	Info	L [mm]	▢	▣	EAN
56H521	PZ1	50	2	50/100	5902062504555
56H522	PZ2	50	2	50/100	5902062504562
56H523	PZ3	50	2	50/100	5902062504579



x6 S2

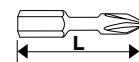
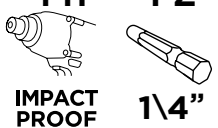

Ref.	Info	L [mm]	▢	▣	EAN
56H540	PH1/PH2/PH3, PZ1/PZ2/PZ3	25	6	50/100	5902062504692



x2

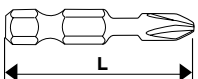
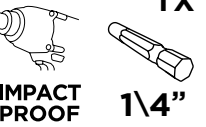

Ref.	Info	L [mm]	▢	▣	EAN
56H524	TX15	50	2	50/100	5902062504586
56H525	TX20	50	2	50/100	5902062504593
56H526	TX25	50	2	50/100	5902062504623
56H527	TX27	50	2	50/100	5902062504647
56H528	TX30	50	2	50/100	5902062504661
56H529	TX40	50	2	50/100	5902062504685



x6

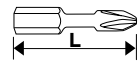
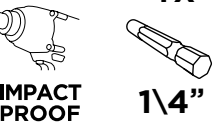
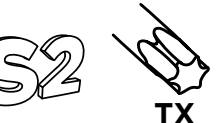

Ref.	Info	L [mm]	▢	▣	EAN
56H541	TX10/TX15/TX20, TX25/TX30/TX40	25	6	50/100	5902062504708

POWER IN YOUR HANDS

Bity udarowe

Impact bits / Schlag-Bits / Ударные вставки / Бити ударні / Ütvecsavarozó bitek / Bit de impact / Üderové bity / Nárázové bity / Udarni biti / Smūginiai antgaliai / Triecienuzgaļi / Löökmeislid / Ударни битове / Udarni bitovi / Udarni bitovi / Κρουστικές μύτες / Bits de impacto / Inserti a percussione / Pontas de percussão / Embouts à choc / Slagbits



x20

S2



PH



IMPACT PROOF



1/4"

Ref.	Info	L [mm]			EAN
56H530	PH1	25	20	10/100	5902062504821
56H531	PH2	25	20	10/100	5902062504838
56H532	PH3	25	20	10/100	5902062504845



x20

S2



PZ



IMPACT PROOF



1/4"

Ref.	Info	L [mm]			EAN
56H533	PZ1	25	20	10/100	5902062504852
56H534	PZ2	25	20	10/100	5902062504869
56H535	PZ3	25	20	10/100	5902062504876
56H536	PZ4	25	20	10/100	5902062504883

x10

S2



PH



PZ



TX



IMPACT PROOF



1/4"

Ref.	Info	L [mm]			EAN
56H562	PH1/PH2/PH3, PZ1/PZ2/PZ3, TX25/ TX27/TX30/TX40	50	10	20/80	5902062504814

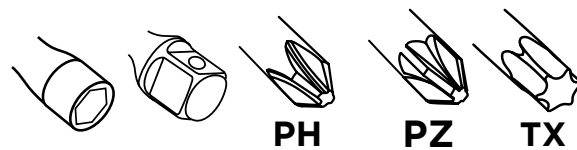

PH

PZ

TX

x36

S2



IMPACT PROOF



1/4"



Ref.	Info			EAN
56H560	16 x PH1/2/2/2/3, PZ1/2/2/3, TX10/15/20/25/27/30/40 - 25 mm, 14 x PH1/2/2/2/3, PZ1/2/2/2/3, HEX3/4/5/6 - 50 mm, 3 x 6, 8, 10 mm - 48 mm, 1 x 90 mm, 2 x adapter 1/4", 1/2" - 50 mm	36	0/10	5902062504807

Końcówki wkrętakowe

Driver bits / Einsätze für Schraubendreher / Насадки / Наконечники викрѹтмови / Csavarhúzó bit / Set biti / Šroubovákové nástavce / Skrutkovacie nástavce / Nastavki za izvijače / Atsuktuvo antgaliai / Skrūvgrieža uzgaļi / Krivķeerajaotsakud / Накрайници за отвѣртка / Nastavci za odvijač / Nastavci za odvijač / Καταβιδόμυτες / Pontas destornilladoras / Punta giravite / Ponteiros Chave de fenda / Embouts de tournevis / Schroevendraaiereindstukken

- ⊕ PH1, PH2x2, PH3
- ⊖ SL4, SL5, SL6
- ⊕ PZ1, PZ2x2, PZ3
- ⊙ HEX4, HEX5, HEX6
- ⊙ TX10, TX15, TX20, TX25, TX27, TX30, TX40

x22



1/4"



Ref.	L [mm]			EAN
57H996	25	22	0/48	5902062579966

Końcówki wkrętakowe

Driver bits / Einsätze für Schraubendreher / Наконечники викрутки / Csavarhúzó bit / Set biti / Šroubovákové nástavce / Skrutkovicie nástavce / Nastavki za izvijače / Atsuktuo antgaliai / Skřůvgrieža uzgali / Kruvikeerajaotsakud / Накрайници за отвертка / Nastavci za odvijač / Nastavci za odvijač / Καταβιδόμετες / Puntas destornilladoras / Punta giravite / Ponteiros Chave de fenda / Embouts de tournevis / Schroevendraaierendstukken

- ⊕ PH0x2; PH1x4; PH2x4; PH3x3
- ⊕ PZ0x2; PZ1x4; PZ2x4; PZ3x3
- ⊖ SL4x2; SL5x2; SL6x2
- H3; H4; H5; H6; H8
- TX10x2; TX15x2; TX20x2; TX25x2; TX27x2; TX30x2; TX40x2
- ⊙ TT10; TT15; TT20; TT25; TT27; TT30; TT40

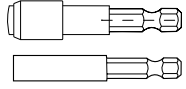

S2



x60

Ref.			EAN
56H600	60	6/24	5902062024411



1/4"

- ⊕ PH1, PH2, PH3
- ⊕ PZ1, PZ2, PZ3
- ⊖ SL3, SL4, SL5, SL6
- H3, H4, H5, H6, H8
- T10, T15, T20, T25, T27, T30, T40
- ⊙ TT10; TT15; TT20; TT25; TT27; TT30; TT40



S2



x18

Ref.			EAN
56H606	18	6/24	5902062024442

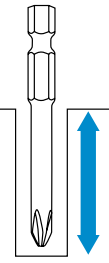

DEEP DRIVE



1/4"

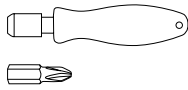

- ⊕ PH1, PH2, PH3
- 0, 1, 2
- HT 2, 2.5, 3, 4, 5
- TT5, TT6, TT7, TT8, TT9,
- TW1, TW2, TW3
- ⊕ 6, 8, 10
- ⊕ TX10, T15, T20, T25, T27, T30
- 4, 6, 8



x31

Ref.			EAN
56H602	31	6/24	5902062024428

S2



1/4"

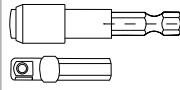

- ⊕ PH1, PH2, PH3
- ⊕ PZ1, PZ2, PZ3
- ⊖ SL3, SL4, SL5, SL6
- H3, H4, H5, H6, H8
- T10, T15, T20, T25, T27, T30, T40
- ⊙ TT10; TT15; TT20; TT25; TT27; TT30; TT40



x32

Ref.			EAN
56H608	32	12/48	5902062024459

S2



1/4"

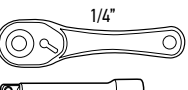

- ⊕ PH1, PH2, PH3
- ⊕ PZ1, PZ2, PZ3
- ⊖ SL4, SL5.5, SL6.5
- H3, H4, H5, H6
- T10, T15, T20, T25, T30
- 6, 7, 8, 10, 13 mm



x26

Ref.			EAN
56H604	26	6/24	5902062024435

S2



1/4"

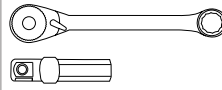

- ⊕ PH1, PH2x2
- ⊕ PZ1, PZ2x2
- H4, H5, H6
- T10, T15, T20, T25, T30, T40
- 6, 7, 8, 10, 11, 13 mm



x24

Ref.			EAN
56H610	24	12/48	5902062024466

S2



1/4"

POWER IN YOUR HANDS

Końcówki wkrętakowe

Driver bits / Einsätze für Schraubendreher / Насадки / Наконечники викрутки / Csavarhúzó bit / Set biti / Šroubovákové nástavce / Skrutkovacie nástavce / Nastavki za izvijače / Atsuktuvo antgaliai / Skrūtvgrieža uzgaļi / Krivikeerajatsakud / Накраїнуци за отвёртка / Nastavci za odvijač / Nastavci za odvijač / Κατασβιδόµυτες / Puntas destornilladoras / Punta giravite / Ponteiros Chave de fenda / Embouts de tournevis / Schroevendraaierendstukken

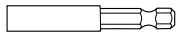

- ⊕ PH2x3, PH3
- ⊕ PZ2x3, PZ3
- ⊖ SL4, SL6
- ⊙ H4, H5, H6
- ⊙ T20x2, T25x2, T30x2, T40
- ⊙ TT10; TT15; TT20; TT25; TT27; TT30; TT40
- ⊕ PH2
- ⊕ PZ2



S2

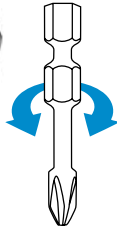

SAFETY FORCE



1/4"



x23

Ref.	Box	Box	EAN
56H612	23	12/48	5902062024473

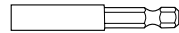

- ⊕ PH1, PH2
- ⊕ PZ1, PZ2
- ⊙ T15, T20, T25, T30



S2

1/4"



x10

Ref.	Box	Box	EAN
56H614	10	24/96	5902062024480

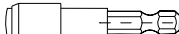

- ⊕ PH1, PH2
- ⊕ PZ1, PZ2
- ⊖ SL5, SL6
- ⊙ H3, H4, H5
- ⊙ T10, T15, T20, T25, T27, T30



S2

1/4"



x15

Ref.	Box	Box	EAN
56H616	15	12/72	5902062024497

Kątowa nasadka na bity

Angle bit driver / Bit-Winkelaufsatz / Угловой битодержатель / Насадка кртова для наконечников / Sarok adapter / Dispozitiv unghiular pentru bituri / Úhlový nástavec pro bity / uhlový nástavec na bity / kotni vijalni nastavek / Kampinis priedas suktnuvi / Lerka uzgaļu turētājs / tarvikute nurkotsak / Ёлов накраїнуци за битове / Kutni držač bitova / Ugaoni adapter za bitove / Γωνιακός προσαρµογέας για µύτες εργαλείων υψηλής ροπής / Adaptador angular para puntas / Adattore angolare / Ponteira angular para bits / Douille angulaire pour embouts



KAT 90°
90° ANGLE



max 600 min⁻¹



Ref	Ø [mm]	maks. moment obrotowy / max torque / макс. крутящий момент	Box	EAN
55H931	1/4" (6.35 mm)	8Nm	6/36	5902062689313

Kątowa nasadka wiertarska

Drill chuck / Bohrfutter / Патрон для дрели / Патрон до дрелю / Fúrótokmány / Mandrină de găurit / Sključadlo pro vrtáky / Slučadlo / Vrtalna glava / Griebtuvas grežtuvui / Urbjmašinas patrona / Drelli radrun / Патрон за бормашина / Stezna glava-borfuter / Stezna glava-borfuter / Κεντροφιλικής δράπανου / Portabrocas / Manubrio di trapano per chiave / Suporte de berbequim / Mandrin de perçage / Boorhouder



KAT 90°
90° ANGLE



max 3000 min⁻¹



Ref	Ø [mm]	Box	EAN
55H932	0.8 - 10	6/24	5902062000453

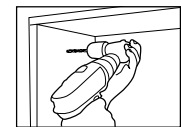
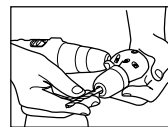
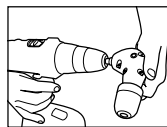

KAT 90°
90° ANGLE



max 1500 min⁻¹



Ref	Ø [mm]	Box	EAN
55H930	0.8 - 10	0/20	5902062689306

Uchwyt wiertarski

Drill chuck / Bohrfutter / Патрон для дрели / Патрон до дрилно / Fúrótokmány / Mandrină de găurit / Skličidlo pro vrtáky / Slučidlo / Vrtalna glava / Griebtuvas gręztuvui / Urbjmašinas patrona / Drelli padrun / Патрон за бормашина / Stezna glava-borfuter / Stezna glavaborfuter / Κεντροσφικτής δράπανου / Portabracas / Manubrio di trapano per chiave / Suporte de berbequim / Mandrin de percege / Boorhouder



56H620

56H622

Ref	Ø [mm]	info		EAN
56H620	1.0 - 13.0	1/2"x20	8/40	5902062045621
56H622	0.8 - 10.0	3/8"x24	10/50	5902062045706

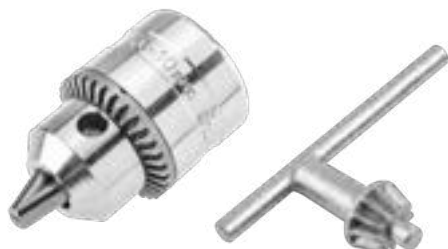

Ref	Ø [mm]	info		EAN
56H630	1.5 - 13.0	1/2"x20	10/50	5902062045645
56H631	1.5 - 10.0	3/8"x24	10/50	5902062045638

Klucz do uchwytu wiertarskiego

Drill chuck key / Bohrfutterschlüssel / Ключ для патрона к дрели / Ключ для патрону до дрелия / Tokmánykulcs / Cheie pentru mandrina / Klíč ke sklíčidlu pro vrtáky / Klíč do sklúčidla / Ključ za vrtalno glavo / Gręztuvo griebtuvo raktas / Urbjmašinas patronas atslęga / Drelli padruni vōti / Ключ за патрон / Ključ za borfuter / Kľuč za borfuter / Κλειδί για κεντροσφικτή δράπανου / Llave para mandril / Chiave per manubrio di trapano / Chave p. suporte de berbequim / Clef de mandrin de perceuse / Boorhandvatsleutel



Ref	Ø [mm]		EAN
56H632	10	0/0	5902062045683
56H633	13	0/0	5902062045690

Rękawice robocze

Working gloves / Arbeitshandschuhe / Перчатки рабочие / Рукавици робочи / Munkakesztyű / Mănuși de lucru / Pracovní rukavice / Pracovné rukavice / Delovne rokavice / Darbo pirštīnes / Darba cimdi / Töökindad / Ръкавици работни / Radne rukavice / Radne rukavice / Γάντια εργασίας / Guantes de trabajo / Luvas de trabalho / Gants de travail / Werkhandschoenen



||
kat./cat.



2 1 2 1
EN 388

Ref	["]		EAN
97G100	10	12/120	5902062092700

Statyw do szlifierek kątowych

Angle grinder support / Gestell für Winkelschleifer / Держатель для угловых шлифмашин / Штатив до шлифмашинику кутових (болгарок) / Állvány sarokcsiszolóhoz / Stativ pentru polizor unghiular / Stojan na úhlové brusky / Stojan na uhlové brusky / Stojalo za kotni brusilnik / Stovas kampiniam šlifuoekliui / Leņķa slīpmašinas statīvs / Statiiv nurklihvijale / Σταθις за ѓλωπλαϊφ / Stativ za kutne brusilice / Stativ za ugaone brusilice / Ορθοστάτης για γωνιακούς λειαντήρες / Soporte para amoladora angular / Supporto per smerigliatrice angolare / Suporte para esmerilhadora de canto / Βάτι pour meuleuses d'angle / Steun voor verstekschuurmachines

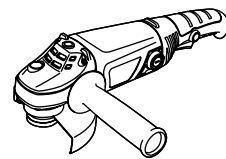

Ø 115 mm
Ø 125 mm



Ref		EAN
56H650	0/4	5902062045652

Statyw do wiertarki

Drill stand / Gestell für Bohrmaschine / Держатель для дрели / Штатив до дрилно / Fúróállvány / Stativ pentru masina de gaurit / Stojan na vrtáčku / Stojan na vřtačku / Stojalo za vrtalnik / Stovas gręztuvui / Urbjmašinas statīvs / Statiiv trellile / Σταθις за пробивна машина / Stativ za bušilicu / Stativ za bušilicu / Ορθοστάτης δρανάνου / Soporte para taladradoras / Supporto per trapano / Suporte de berbequim / Βάτι pour perceuse / Steun voor boormachine

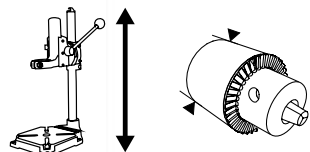

400mm Ø 43 mm

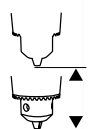

max 60 mm

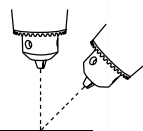

max 90°



Ref		EAN
56H655	0/6	5902062045676

POWER IN YOUR HANDS

VERTO



VERTO





**JEST TYLE DO ZROBIENIA
THERE IS SO MUCH TO DO
ТАК МНОГО НУЖНО СДЕЛАТЬ ДЕЛ**

VERTO to:

- szeroka gama elektronarzędzi i akcesoriów oraz narzędzi ogrodowych do twojego domu, warsztatu oraz ogrodu
- wszechstronne, wygodne w obsłudze rozwiązania w bardzo dobrej relacji jakości do ceny
- produkty idealnie sprawdzające się przy średnich obciążeniach

VERTO is:

- A wide range of power tools and accessories for your home, workshop and garden
- versatile, convenient solutions with very good quality to price ratio
- products perfectly fit to moderate load

VERTO – это

- широкая гамма электроинструмента, а также садового инструмента и принадлежностей для дома, мастерской и огорода
- комплексные, удобные в эксплуатации решения в хорошем соотношении цена-качество
- товары, идеально подходящие для выполнения работ средней тяжести



VERTOTOOLS



Informacje o nowościach produktowych, porady oraz VIDEO

Information on new products, advice and VIDEOS

Информация о новых продуктах, советы и ВИДЕО



VERTOTOOLS



VIDEO produktowe, porównania i testy produktów w wielu wersjach językowych

Product related VIDEOS, product comparisons and tests in multiple language versions

ВИДЕО о продуктах, сравнение и тесты продуктов в различных языковых версиях

Nasze wieloletnie doświadczenie i znajomość rynku narzędzi pomogła nam w opracowaniu rozwiązań ekspozycji produktów, które wspierają naszych partnerów handlowych w codziennym biznesie.

- **unikalność** - regały dedykowane dla marki VERTO
- **solidność** - konstrukcje wykonane z dobrej jakości materiałów
- **nowoczesność** - ciekawe rozwiązanie na komunikację o produktach, markach, akcjach promocyjnych
- **uniwersalność** – odpowiednie dopasowanie do ilości miejsca w sklepie

Many years of experience and knowledge of tool market allowed us to develop solutions for product exposition, which create a great support in everyday business for our trade partners.

- **unique features** – cabinets dedicated for VERTO brand
- **reliability** - designs include good quality materials
- **modern design** – interesting solution for communication about products, brands, promotional events
- **versatility** – matching to space available in a shop

Благодаря нашему многолетнему опыту и знанию рынка инструмента, мы разработали решения по эффективной презентации товаров, которые помогают нашим коммерческим партнерам в их повседневной работе.

- **уникальность** - стеллажи, предназначенные для бренда VERTO
- **прочность** - конструкции изготовлены из материалов хорошего качества
- **современность** - интересные решения по маркетинговой коммуникации - о товарах, брендах, промо-акциях
- **универсальность** – специальные решения с учетом площади магазина

OFERTA SZYTA NA MIARĘ TAILORED-MADE OFFER ОФЕРТА ПОД ЗАКАЗ



KOSA SPALINOWA

Petrol Grass Cutter / Motorsense / Бензотриммер / Косарка бензинова / Motoros fűkasza / Motocoasa pe benzina / Benzinová kosa / Benzinová kosa / Motorna kosa / Trimeris / Benzina trimeris / Bensiniimootoriga trimmer / Моторна коса / Benzinska kosilica / Kosa sa unutrašnjim sagorevanjem / Χλοοκοπτικό βενζινοκίνητο / Motoguadaña / Decespugliatore a scoppio / Segadeira de combustão / Faux à essence / Motorzeis

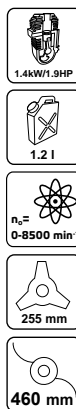

Ref.	P [kW]	☒	EAN
50G490	1.4	0/2	5902062524904



Ref.	P [kW]	☒	EAN
50G491	1.2	0/2	5902062026019

SZPULA Z ŻYŁKĄ TNACĄ

Cutting line for petrol grass cutter / Schneideseil für Motorsense / Лесна для бензонасы / Струна до моторносы / Vágószínor motoros fűkaszához / Fir tăietor pentru cositoare / Struna do benzinové kosa / Zacia struna do benzinovej kosačky / Nitka za bencinsko kosilnico / Valas pjúkluvi su vidaus degimo varikliu / Džisla iekšējēdes trimerim / Murutrimmeri jöhv / Ножа за бензинова косачна / Rezna nit za benzinsku kosilicu / Žilica za kosa sa unutrašnjim sagorevanjem / Μεταίεζα βενζινοκίνητου χλοοκοπτικού / Hilo de nilón para motoguadaña / Filo per tagliaerba / Linha para ceifadeira / Fil à coupeur d'herbes / Lijn voor motorzeis



Ref.	for	☒	EAN
50G490-134	50G490	0/1	5902062183040
K74834	50G491	0/1	5902062028884
K113791	52G550	0/1	5902062064394
K113813	52G551, 52G552	0/1	5902062064431

NÓZ DO KOSY SPALINOWEJ

Lawn mower blade / Messer für Rasenmäher / Ножи для газонокосилки / Hók do газонокосарки / Vágókés fűnyíróhoz / Cuțit de cositoare / Nůž do sekačky / Nůž do kosačky / Reziło za kosilnico / Peilis žoliapjovei / Nazis plaujmašinai / Niidukitera / Ножи за косачна / Nož za kosilicu / Nož za kosilicu / Λεπίδα χλοοκοπτικής μηχανής / Hoja para cortacésped / Mes voor motorzeis



Ref.	for	☒	EAN
50G490-30	50G490	0/50	5902062183057

PODKASZARKA DO TRAWY

Grass trimmer / Rasentrimmer / Газонокосилка / Газонокосарка / Fűszegélynyíró / Cositoare de gazon / Vyžinač trávy / Vyžinač / Reznalnik za travo / Žoliapjove - trimeris / Mauriņa trimeris / Murutrimmer / Косачка тример за трева / Trimer za travu / Kosa za travu / Χλοοκοπτική μηχανή / Podadora de bordes para césped / Tosaerba a filo / Coupeur d'herbe / Grasschar



Ref.	[W]	☒	EAN
52G550	350	0/6	5902062510181



Ref.	[W]	☒	EAN
52G551	450	0/4	5902062510198



Ref.	[W]	☒	EAN
52G552	550	0/4	5902062510204



VERTO

KOSIARKA ELEKTRYCZNA

Electric lawn mower / Elektrorasenmäher / Газонокосилка электрическая / Газонокосарка електрична / Elektromos fűnyíró / Cositoare electrica / Elektrická sekačka / Elektrická kosačka / Električna kosilnica / Elektrinė žoliapjovė / Elektriskā plaujmašīna / Elektriline muruniiduk / Электрическая косачка / Električna kosilica / Elektrická kosilka / Ηλεκτροκίνητη χλοοκοπτική μηχανή / Cortacésped eléctrico / Rasaerba elettrico / Ceifeira elétrica / Tondeuse électrique / Elektrische maaiër



Ref.	[W]	☒	EAN
52G573	1300	0/1	5902062011015



NOŹ DO KOSIARKI

Blade for electric lawn mower / Messer für Rasenmäher / Нож для газонокосилки / Нож до газонокосарки / Penge fűnyíróhoz / Cuțit pentru cositoare / Nóż do sekačky / Nóż do kosačky / Reziło za kosilnico / Peilis žoliapjovėi / Pļāvēja nazis / Trimmeri tera / Нож за косачка / Nož za kosilicu / Sečivo za kosilicu / Μαχαίρι για χλοοκοπτική μηχανή / Cuchilla para cortacésped / Lama per tosaerba / Lámina para cortador de relva / Couteau pour tondeuse / Mesblad voor grasmaaier



Ref.	for	☒	EAN
K85081	52G573	0/1	5902062054180
K84925	52G574	0/1	5902062051134
K85002	52G575	0/1	5902062053244

SEKATOR AKUMULATOROWY

Cardless pruning scissors / Gartenschere Akku / Секатор аккумуляторный / Секатор акумулаторный / Akkumulátoros metszőolló / Foarfece de gradina cu acumulator / Akumulátorové zahradnické nůžky / Záhradné nožnice akumulátorové / Akumulatorski sekalnik / Akumulatoriinis sektorius / Akumulatora dārze grieznes / Akutoitel löikur / Градински ножници акумулаторни / Akumulatorske škare / Akumulatorske makaze / Φαλίδι κλαδέματος επαναφορτιζόμενο / Podador a batería / Cesoie electrice / Corta-sebes de bateria / Sécateur à batterie / Takkenschaar



Ref.	[V]	[Ah]	☒	EAN
52G300	7,2	1,3	0/8	5902062010988



Ref.	[W]	☒	EAN
52G574	1600	0/1	5902062045102



OSTRZE

Blade / Schneide / Лезвие / Вістря / Penge / Tăiş / Ostří / Čepele / Reziło / Ašmenys / Asmeņi / Terad / Ocmpeue / Oštrica / Oštrica / Λεπίδα / Hoja / Lama / Lámina / Blad



Ref.	for	☒	EAN
K00073	52G300	0/1	5902062016249



Ref.	[W]	☒	EAN
52G575	1800	0/1	5902062045119



SEKATOR AKUMULATOROWY

Cordless pruning scissors / Gartenschere Akku / Секатор аккумуляторный / Секатор аккумуляторный / Akkumulátoros metszőolló / Foarfece de gradina cu acumulator / Akumulátorové zahradnické nůžky / Záhradné nožnice akumulátorové / Akumulatorski sekalnik / Akumulátorinis sekatorius / Akumulatōra dāra / Grieznes / Akutoitel tōkur / Граднски нoжици акумулаторни / Akumulatorske škare / Akumulatorske makaze / Ψαλίδι κλαδέματος επαναφορτιζόμενο / Podador a batería / Cesioie elettriche / Corta-sebes de batería / Sécateur à batterie / Takkenschaar



Ref.	[V]	[Ah]	☒	EAN
52G311	7,2	1,3	0/5	5902062011008

OSTRZE

Blade / Schneide / Лезвие / Вістря / Penge / Tais / Ostří / Čepele / Rezilo / Ašmenys / Asmeni / Terad / Оцмие / Oštrica / Oštrica / Лепида / Hoja / Lama / Lámina / Lame / Blad



Ref.	for	info	☒	EAN
K00103	52G311	hedge blade 120 mm	0/1	5902062016546
K00104	52G311	grass blade 80 mm	0/1	5902062016553

NOŽYCE DO ŽYVOPLOTU

Hedge trimmer / Heckenschere / Ножницы для живой изгороди / Ножици до живоплоту / Sövényvágó / foarfece p't gard viu / Nůžky na živý plot / Nožnice na živý plot / Škarje za živo mejo / Žirkles gvatvoren / Dživžoga škères / Hekipigajga / Храстореза / Škare za živicu / Makaze za živicu / Θαμνοκοπτικό μηχανήμα / Cortasetos eléctrico / Tagliasiepi elettrico / Tesoura p. Vedação / Cisaille à haie / Hekschaar

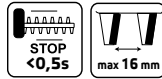
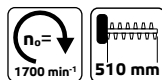

Ref.	[W]	☒	EAN
52G567	600	0/4	5902062026057

POMPA WODNA ZANURZENIOWA DO BRUDNEJ WODY

Dirty water submersible pump / Wassertauchpumpe für Schmutzwasser / Насос погружной для грязной воды / Насос водний заглибний до стічних вод / Merülő szennyvízszivattyú / Pompa de cufundat in apa murdara / Vodni pomocné čerpadlo na špinavou vodu / Pomorné čerpadlo na znečistenú vodu / Potopna vodna črpalčka za umazano vodo / Panardinama vandens pompa užierštam vandeniu / legremdejamais üdenssükis netiram üdenim / Sukelpump mudasele veele / Подводна помпа за мръсна вода / Crpka za vodu - uranjajca - za prljavu vodu / Pumpa za vodu potopljena u prljavu vodu / Καταβυόμενη αντλία ακάθαρτων υδάτων / Pompa a immersione per acque sporche / Bomba de água de imersão / Pompe à eau immergée / Dompelpomp voor vies water

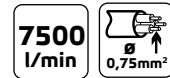
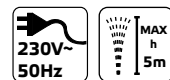
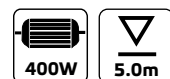

Ref.	[W]	☒	EAN
52G441	400	0/4	5902062009852

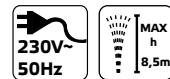
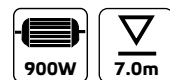

Ref.	[W]	☒	EAN
52G449	900	0/4	5902062010384



VERTO

MYJKA CIŚNIENIOWA

High pressure cleaner / Druckreiniger / Мойка высокого давления / Мийка під тиском / Magasnyomású mosó / Maşină de spălat sub presiune / Vysokotlaký čistič / Tlaková vodná čistička / Visokotlačni čistilec / Sleginis indas / Augstspiediena mazgātne / Surverpesur / Мийка под налягане / Tlačni čistič / Čistač pod tlakom / Πιεστικό / Limpiadora de presión / Adopulitrice / Aparelho de lavar de pressão / Nettoyeur à eau haute pression / Drukreiniger



- 1400W
- 230V~50Hz
- max 110 bar
- 80 bar
- 5.5 l/min

Ref.	[W]	bar		EAN
52G401	1400	80 (maks. 110)	0/1	5902062510082

ODKURZACZ OGRODOWY

Garden vacuum cleaner / Gartenstaubsauger / Пылесос садовый / Пилосос садівничий / Lombszívó / Aspirator de gradina / Zahradní vysavač / Záhradný vysávač / Sesalnik za vrt / Laru siurblys / Dārza puteklšūcējs / Leheimur / Градинска прахосмукачка / Vrtni usisavač / Vrtnarski usisivač / Ηλεκτρικός αναρροφητήρας / Aspiratore da giardino / Aspirador de jardim / Aspirateur de jardin / Tuinstofzuiger



- 2800W
- 230V~50Hz
- n=8000 14000 min⁻¹
- max 275 km/h
- 40l

Ref.	[W]		EAN
52G500	2800	0/1	5902062505002



- 1600W
- 230V~50Hz
- max 130 bar
- 90 bar
- 6 l/min

Ref.	[W]	bar		EAN
52G402	1600	90 (maks. 130)	0/1	5902062510099



- 500W
- 230V~50Hz
- 2.2 m³/min
- n=16000 min⁻¹

Ref.	[W]		EAN
52G505	500	0/8	5902062525055



- 2000W
- 230V~50Hz
- max 160 bar
- 110 bar
- 6.5 l/min

Ref.	[W]	bar		EAN
52G403	2000	110 (maks. 140)	0/1	5902062510105



PILARKA ŁAŃCUCHOWA

Chain saw / Elektrokettensäge / Пила цепная / Пилка ланцюгова / Láncfűrész / ferestrău cu lanț / Řetězová pila / Refazová pila / Verižna žaga / Grandininis, pjūklas / Kėžu žągis / Kettisaag / Вержсен тпуон / Lančana pila / Lančana testera / Ηλεκτροκίνητο αλυσόπριονο / Elettrosega a catena / Electro-serra de corrente / Scie à bois à chaîne / Kettingzaag



Ref.	[W]	☒	EAN
52G584	2000	0/2	5902062505842

ŁAŃCUCH

Chain for chainsaw / Kette für kettensäge / Цепь для цепных пил / Ланцюг до пилки ланцюгової / Fűrészlánc láncfűrészhez / Lant pentru ferastrau cu lanț / Řetěz pro řetězovou pilu / Řetěz do refazovej pily / Veriža za verižno žago / Grandinini, pjūklis / Kėdes žągis / Kettisaag / Вержсен тпуон / Lanac za lančanu pilu / Lanac za lančanu testeru / Αλυσίδα αλυσόπριονο / Cadena para sierra de cadena / Catena per sega a catena / Corrente para motoserra / Chaîne de tronçonneuse à chaîne / Ketting voor kettingzaag



Ref.	for	☒	☒	☒	EAN
52G584-71	52G584	0.375"	0.472"	0/1	5902062222244

PROWADNICA

Sword for chain saw / Kettensägeführung / Направляющая к пиле / Шина напрямна до пилки ланцюгової / Kardfűrész / Spadě ferestrău cu lanț / Vodící lišta řetězové pily / Lišta pre refazovej pily / Meč za verižno žago / Kreipiančioji grandininiam pjūklis / Sliede kėžu žągim / Kettisaag / Вержсен тпуон / Guía para sierra de cadena / Guida per la sega a catena / Guias de motoserra / Guidage pour scie à chaîne / Geleider voor kettingzaag



Ref.	for	L [mm]	☒	EAN
52G584-73	52G584	275	0/20	5902062222237

OSTRZAŁKA DO ŁAŃCUCHA

Chain sharpener / Kettenschärfergerät / Точилка для цепи бензопилы приспособления для гострильной пильных ланцюгов / Láncélező / Masina de ascuțit lanturi / Ostříčka řetězů / Bruska na řetaze / Brusilnik za veriže / Galagstuvus grandinei / Kėdes asinātājs / Ketiteritaja / Заточваща машина за верижу / Oštrač lanca / Oštrač za lanac / Ακονιστήρι αλυσίδας βενζινοκίνητου αλυσόπριονο / Aflador de cadena / Affilcatene per motosega ed elettrosega / Afador de correntes / Affôteuse de chaîne / Ketting slijptoezel



Ref.	[W]	☒	EAN
52G502	180	0/4	5902062525024

TARCA DO OSTRZAŁKI

Sharpener disc / Scheibe für Kettenschärfergerät / Диск для точильной машины / Диск шлифовальный для гострильной / Пильных ланцюгов / Kőszőrűkorong láncélezőhöz / Disc abraziv pentru masina de ascuțit lanturi / Kotouč pro ostříčku / Kotuč k ostričce / Brusna plošča za brusilnik / Asinātāja disks / Ketiteritaja ketas / Диск на заточваща машина / Disk za oštrač / Kolut za oštrenje / Τροχος για μηχανή ακονισματος / Disco para aflador / Disco para affilcatene / Disco para afiadora / Disque d'affûtage

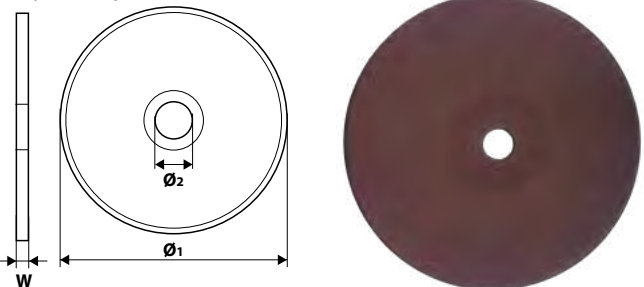

Ref.	for	Ø1/Ø2 [mm]	W [mm]	☒	EAN
52G502-17	52G502	100/10.2	3.2	0/1	5902062485243

WKRĘTAK AKUMULATOROWY

Cordless screwdriver / Akku-Schrauber / Отвертка аккумуляторная / Шрубовеерт акумулаторной / Akkus csavarbehajtó / Surubelnija fāra fir / Akumulátorový šroubovák / Skrutkovač AKU / Baterijski izvijač / Akumulatorinis suktuvas / Skūrviežis akumulatora / Akukruvikeeraja / Отвертка / Akumulatorski odvijač / Akumulatorski odvijač Επαναφορτιζόμενο κατσαβίδι / Destornillador a batería / Cacciavite senza filo / Chave de fenda de bateria / Tournevis à batteries / Accu schroevendraaier



Ref.	[V]	[Ah]	☒	EAN
50G139	3,6	1,5	0/10	5902062044792



VERTO

WIERTARKO-WKRĘTARKA AKUMULATOROWA

Cordless drill / Akkuboehrschrauber / Дрель-шуруповерт аккумуляторная / Дрель-шуруповерт аккумуляторный / Akkumulátoros fűrészsavarozó / Bormasina-surubelnita cu acumulator / Akumulátorová vrtáčka-šroubovák / Akumulátorový vrtací skrutkovač / Akumulatorski vrtalnik-vijačnik / Akumulatorinis grežtuvas - suktuvas / Akumulatora urbjmašina-skrūvgriezis / Akutrell / Аккумуляторен пробивен винтоверт / Akumulatorska bušilica - izvijač / Akumulatorska bušilica - odvijač / Επαναφορτιζόμενο βραχίονο-κατάρτιδο / Taladradora atomilladora a batería / Trapano avvitatore a batteria / Aparafuradora de batería / Perceuse-visseuse à batterie / Accu boor-draaimachine



Li-Ion

1.3Ah



Ref.	[V]	[Ah]	☒	EAN
50G273	10,8	2x 1,3	0/10	5902062057259



Li-Ion

1.5Ah



Ref.	[V]	[Ah]	☒	EAN
50G290	20	1.5	0/10	5902062508768



Li-Ion

1.5Ah



Ref.	[V]	[Ah]	☒	EAN
50G291	20	2x 1.5	0/5	5902062508775

ZESTAW WIERTARKO-WKRĘTARKA + LATARKA AKUMULATOROWA

Set of cordless drill + rechargeable torch / Set akku-boehrschrauber + akku-taschenlampe / Набор дрель-шуруповерт аккумуляторная + фонарь аккумуляторный / Набор дрель-шуруповерт аккумуляторный + ліхтар, що підзаряджається / Készlet akkus fűrészsavarozó + elemilámpa akkus-töltő / Set de burghiu fără fir + torță reîncărcabilă / Sada akumulátorová vrtáčka-šroubovák + akumulátorová baterka / Sada vrtáčka aku + lampa dobijacia / Niz baterijski izvijač/vrtalnik + baterijski svetilka / Rinkinis akumulatorinis grežtuvas - suktuvas + akumulatorinis žibintuvelis / Kopa akumulatora urbjmašina-skrūvgriezis + akumulatora lukturītis / Komplet akudrell + taastādetav pēlētī / Комплект от бормашина + акумулаторна горелка / Skup od akumulatorska bušilica + baklja koja se može puniti / Set od akumulatorska busilica + lampna na punjenje / Συνολο απο επαναφορτιζόμενο βραχίονοκατάρτιδο + επαναφορτιζόμενο φρακός / Conjunto de taladradora atomilladora a batería + linterna recargable / Set di trapano avvitavite senza filo + lampadina frontale / Conjunto de aparafuradora de batería + linterna de batería / Ensemble de perceuse-visseuse à batterie + torche à batterie / Set van accu boor-draaimachine + accu zaklamp



Li-Ion

1.5Ah



Ref.	[V]	[Ah]	☒	EAN
50G293	20	2x 1.5	0/5	5902062508799

ZAKRĘTARKA AKUMULATOROWA

Cordless driver / Akku-schraubmaschine / Гайковерт аккумуляторный / Муртоверт аккумуляторный / Akkumulátoros csavarozó / Inchizător de acumulator / Akumulátorový šroubovák / Akumulatorski vrtalnik / Akumulatorinis suktuvas / Akumulatora uzvāznis / Keerterpuur / Ударен гайковерт / Akumulatorski zavijač / Akumulatorski navojni čep / Επαναφορτιζόμενο κατάρτιδο / Dispositivo de cierre a batería / Svitabulloni a batteria / Máquina de travar com bateria / Visseuse à batterie / Accu schroefmachine



Li-Ion

1.5Ah



Ref.	[V]	[Ah]	☒	EAN
50G292	20	1.5	0/10	5902062508782

AKUMULATOR

Battery / Akkumulátor / Аккумулятор / Акумулятор / Akkumulátor / Acumulator / Akumulátor / Akumulátor / Akumulatorius / Akumulators / Aku / Акумулятор / Akumulator / Akumulator / Ηλεκτρικός συσσωρευτής / Batería / Accumulatore / Bateria / Batterie / Accu



Ref.	[V]	[Ah]	type	for	☒	EAN
K02026	10,8	1,3	Li-Ion	50G272, 50G273	0/1	5902062018816
K/50G284-12	14,4	1,3	Li-Ion	50G284, 50G285	0/1	5902062043719
K28819	14,4	1,3	Li-Ion	50G274, 50G275	0/1	5902062022974
K/50G287-12	18	1,3	Li-Ion	50G287, 50G288	0/1	5902062043726
K28823	18	1,3	Li-Ion	50G277, 50G278	0/1	5902062023018
K74845	18	1,5	Ni-Zn	50G187	0/1	5902062028945
K113881	20	1,5	Li-Ion	50G290, 50G291, 50G292, 50G293	0/1	5902062065209

ŁADOWARKA

Charger / Ladegerät / Зарядное устройство / Зарядний адаптер / Akkumulátortöltő / Incărcător / Nabijačka / Nabijačka / Polnilnik / Įkroviklis / Lādētājs / Laadija / Зарядно устрoство / Punjač / Punjač / Φορτιστής / Cargador / Caricabatterie / Carregador / Chargeur / Oplader



Ref.	for	☒	EAN
K113885	50G290, 50G291, 50G292, 50G293	0/1	5902062065230
K74846	50G187	0/1	5902062028952
K02027	50G272, 50G273	0/1	5902062018823
K78972	50G284, 50G285	0/1	5902062041821
K78975	50G287, 50G288	0/1	5902062041869
K28820	50G274, 50G275	0/1	5902062022981
K28824	50G277, 50G278	0/1	5902062023025

ZASILACZ DO AKUMULATORÓW

Battery charger / Akku-Ladegerät / Зарядное устройство / Зарядний пристрій для акумуляторів / Akkumulátortöltő / Incărcător pentru acumulatori / Nabijačka baterij / Nabijačka akumulatora / Polnilnik za akumulatorje / Akumulatorių įkroviklis / Akumulatoru lādētājs / Akulaadija / Зарядно устрoство за акумуляторите / Punjač za akumulator / Φορτιστής / Cargadora para baterías / Caricabatterie / Carregador de baterias / Chargeur à batteries / Accuoplader



Ref.	[V]	[mA]	info	☒	EAN
K90234	5	800	50G139	0/1	5902062058706
K74847	24	300	50G187	0/1	5902062028969
K/50G271-14	13,5	350	50G271, 50G272, 58G210, 50G273	0/1	5902062014443
K28838	16,8	300	50G274, 50G275	0/1	5902062023032
K/58G150-14	6	300	50G137	0/1	5902062476135

WIERTARKA UDAROWA

Impact drill / Bohrhämmer / Дрель ударная / Дрель ударной / Ütvefúró / Perforator de lovit / Priklepová vrtačka / Priklepová vrtačka / Udarni vrtalnik / Grežtuvas su kalimu / Stitena urbinašina / Löökdrill / Бормашина ударна / Udarna bušilica / Udarna busilica / Κρουστικό δράπανο / Taladro de impacto / Trapano traforatore / Berbequim de impacto / Perceuse à choc / Slagboormachine



Ref.	P [W]	☒	EAN
50G515	500	0/10	5902062033963
50G519	600	0/5	5902062033970



Ref.	P [W]	☒	EAN
50G521	1050	0/5	5902062039934



Ref.	P [W]	☒	EAN
50G519K	600	0/5	5902062503602



VERTO

WIERTARKA UDAROWA

Impact drill / Bohrerhammer / Дрель ударная / Дрель ударный / Üvefúró / Perforator de lovit / Přiklepová vrtáčka / Priklepová vrtáčka / Udarni vrtalnik / Grežtuvas su kalimu / Sitiena urbjmašina / Löökdrell / Бормашина ударна / Udarna bušilica / Udarna busilica / Κρουστικό δρέπανο / Taladro de impacto / Trapano traforatore / Berbequim de impacto / Perceuse à choc / Slagboormachine

ACCESSORIES INCLUDED
62

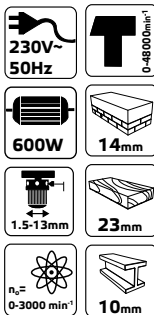

Ref.	P [W]	⊠	EAN
50G539	600	0/5	5902062044082

ΜΕΛΩΤΩΙΕΡΤΑΡΚΑ

Rotary Hammer Drill / Hammerbohrmaschine / Перфоратор / Перфоратор / Fúrókalapács / Ciocan rotopercurtor / Vrtací kladivo / Vrtacie kladivo / Vrtalno kladivo / Perforatorius / Perforators / Puurvasar / Перфоратор / Čekić-bušilica / Čekić-bušilica / Κρουστικό δρέπανο / Martillo percutor / Martello perforatore / Martelo-Berbequim / Perceuse-marteau / Harmerboor

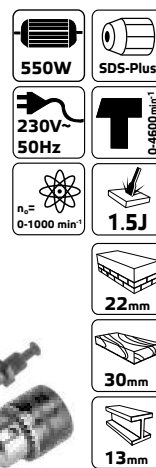

Ref.	P [W]	⊠	EAN
50G365	550	0/5	5902062503657

ACCESSORIES INCLUDED
62

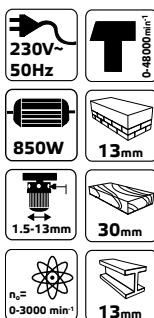

Ref.	P [W]	⊠	EAN
50G528	850	0/5	5902062039958

ΜΕΛΩΤ UDAROWY

Hammer drill / Schlaghammer / Малоток отбойный / Перфоратор / Fúrókalapács / Perforator - ciocan de lovit / Kyvadlové kladivo / Skrutkovač AKU / Udarno kladivo / Perforatorius / Sitiena urbjmašina / Vasardrell / Къртач / Čekić bušilica / Hamer busilica / Κρουστικό δρέπανι / Martillo de percusión / Martello demolitore / Martelo de impacto / Marteau à chocs / Slaghammer



ACCESSORIES INCLUDED
9



Ref.	P [W]	⊠	EAN
50G387	900	0/3	5902062503879

ZESTAW ELEKTRONARZĘDZI

Power tool set / Elektogeräteset / Набор электроинструментов / Набор электроинструменту / Elektromos szerszámkészlet / Set de scule electrice / Sada elektrického náradí / Súprava elektrického náradia / Komplet elektrinih orodij / Elektrinių įrankių komplektas / Elektroinstrumentu komplekts / Elektritööriistade komplekt / Комплект електроинструменту / Set elektrinih uredaja / Komplet elektroredaja / Σει ηλεκτρικών εργαλείων / Juego de herramientas eléctricas / Completo di elettrooutensili / Kit de eletroferamentas / Jeu d'outils électriques / Set van elektrogereedschap

ACCESSORIES INCLUDED
9

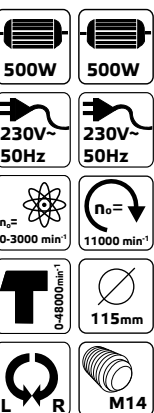

Ref.	⊠	EAN
52G106	0/4	5902062057648

ACCESSORIES INCLUDED
8



Ref.	P [W]	⊠	EAN
50G390	1500	0/2	5902062503909

SZLIFIERKA KĄTOWA

Angle grinder / Winkelschleifer / Шлифмашина угловая / Шліфмашинка нарізна / Sarokcsiszoló / Mașină unghiulară de șlefuit / Bruska úhlová / Brúska uhlová / Kotni brusilnik / Kampinis šlifjuoklis / Lenka slipmašina / Nurklihvija / бѐлошлайф / Brusilica kutna / Brusilica ugaona / Γωνιακός τροχός / Amaladora angular / Smerigliatrice angolare / Disco de limar p. cantos / Meuleuse d'angle / Verstekschuurmachine

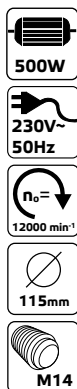

Ref.	P [W]	⊠	EAN
51G053	500	0/6	5902062013576

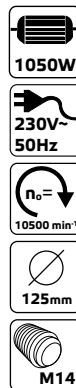

Ref.	P [W]	⊠	EAN
51G096	1050	0/6	5902062013606

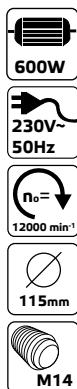

Ref.	P [W]	⊠	EAN
51G061	600	0/8	5902062013583



Ref.	P [W]	⊠	EAN
51G098	1050	0/6	5902062510983

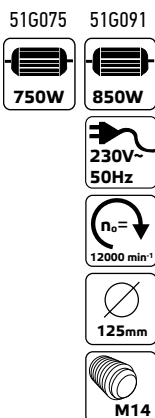

Ref.	P [W]	⊠	EAN
51G075	750	0/6	5902062013590
51G091	850	0/6	5902062510969

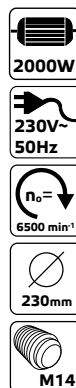

Ref.	P [W]	⊠	EAN
51G203	2000	0/2	5902062006035



VERTO

MINISZLIIFIERKA

Minigrinder / Minischleifmaschine / Минишлифмашина / Мінішлифмашина / Multifunkciós fúrógép / Minipolizor / Minibruska / Brúška mini + príslušenstvo / Mini bruslinik / Mini šljfuočlis / Šljpašina mini / Minijahvati teleskoopalus / Шлайф мну / Brusilica mini / Brusilica mini / Μινι - τροχείο / Mini amoladora recta / Minitrapano fresatore / Esmerilhadora mini / Mini-ponceuse / Mini sljpmachine

41
ACCESSORIES INCLUDED

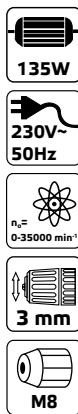

Ref.	P [W]	☒	EAN
51G014	135	0/10	5902062510143

POLERKA

Polisher / Poliermaschine / Машина полировальная / Машина полирувальна / Polirozógép / Dispozitiv šlefuire / Leštička / Brúška excentrická / Polirka / Poliruoklis / Pulētājs / Polerimisvahēnd / Машина за полиране / Polir aparat / Polir aparat / Λεαντήρας / Pulidora / Lucidatrice / Aparelho polidor / Polisseuse / Polijstmachine

8
ACCESSORIES INCLUDED



Ref.	P [W]	☒	EAN
51G726	120	0/2	5902062517265

SZLIIFIERKO-OSEŁKA STOŁOWA

Wet-dry bench grinder / Tischnschleif- und Schärfmaschine / Станок шлифовально-точильный / Станок шлифовально-точильный / Kőszűrőgép / Strung de șlefuit umed-uscat / Bruska na mokro/sucho stolni / Brúška stolová kombinovaná / Namizni bruslinik / Stacionarus šljfuočlis, sausam/šlapiam šljfavamui / Galda sljpašina / Kuiv-märg lihvimispink / Шмупзеи / Dvostrano točilo / Dvostrano točilo / Επιτραπέζιος τροχός ακονισματος / Esmeriladora de banco / Smerigliatrice da banco combinata / Disco de limar, polir de mesa / Meuleuse d'établi à aiguiser / Tafelschuur-sljpmachine

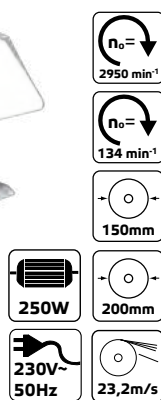

Ref.	P [W]	☒	EAN
51G452	250	0/1	5902062514523

SZLIIFIERKA STOŁOWA

Bench grinder / Tischnschleifmaschine / Машина шлифовальная настольная / Шліфмашина верстатна / Kőszűrőgép / Utillaj de șlefuit / Stolni bruska / Brúška stolová / Namizni bruslinik / Stacionarus šljfuočlis / Galda sljpašina / Lihvimispink / Шмупзеи / Dvostrano točilo / Dvostrano točilo / Τροχός επιτραπέζιος / Amoladora de banco / Smerigliatrice da banco / Disco de limar de mesa / Meuleuse d'établi / Tafelschuurmaschine



Ref.	P [W]	☒	EAN
51G425	120	0/1	5902062160034



Ref.	P [W]	☒	EAN
51G450	200	0/1	5902062160041



Ref.	P [W]	☒	EAN
51G427	350	0/1	5902062160034

PILARKA SZABLÓWA

Sabre saw / Motorstichsäge / Сабельная пила / Пила шабелна / Szablyafűrész / Ferästräu sabie / Savlová pila / Chvostová pila / Sabljasta žaga / Tiesinis pjūklas / Zobenzägis / Saabelsaag / Сабелна пила / Sabljasta pila / Sabljasta testeraσαβόσαγα / Sierra de vaivén / Sega universale / Serra de sabre / Scie à sabre / Sabelzaag



Ref.	P [W]	⊠	EAN
52G166	710	0/6	5902062015723

WYRZYNARKA

Jigsaw / Ausschneidemaschine / Лобзик электрический / Лобзик / Dekopířűrész / Ferästräu / Vyřezávací pila / Priamočiara pila / Vbodna žaga / Pjūkleis / Figürzägis / Jöhvsaaq / Трoшн зезе / Ubodna Pila / Ubodna testera / Σέγα / Sierra de calar / Seghetto alternativo / Máquina de entalhar / Scie sauteuse / Decoupeerzaag

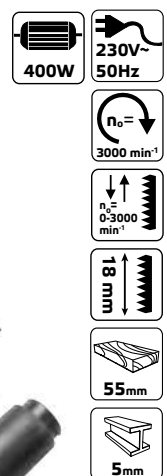

Ref.	P [W]	⊠	EAN
52G064	400	0/10	5902062015778

PILARKA TARCZOWA

Circular saw / Kreissäge / Пила дисковая / Пила циркулярна / Körfűrész / Feresträu circular / Kotoučová pila / Pila kotučová / Krožna žaga / Diskinis pjūklas / Cirkulärzägis / Kreissaag / Циркуляр / Kružna Pila / Kružna testera / Διακοπίο / Sierra circular / Sega circolare / Plainade disco / Scie circulaire / Schijfzaag



Ref.	P [W]	⊠	EAN
52G682	1200	0/4	5902062526823



Ref.	P [W]	⊠	EAN
52G056	600	0/10	5902062508812
52G058	710	0/10	5902062508829

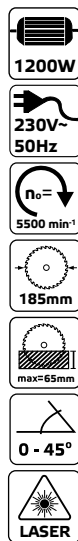

Ref.	P [W]	⊠	EAN
52G684	1200	0/4	5902062526847

URZĄDZENIE WIELOFUNKCYJNE

Multi-function tool / Mehrfunktionsgerät / Многофункциональный инструмент / Βαγοτοφυνκτιώνηη πρoσπίη / Töbpfunktiós berendezés / Dispozitiv multifuncional / Multifunkční zařízení / Multifunkčné zariadenie / Veçfunktcijska naprava / Daugifunkcinis įrankis / Daudzfunkcionālā iekārta / Multifunktsionálne seade / Μυλτιφυνκτιοναλνo υστρούςτμο / Višenamjenski uređaj / Višefunkcionalni uređaj / Εργαλείο πολλαπλών χρήσεων / Dispositivo multifunción / Dispositivo multifunzione / Dispositivo multifuncional / Appareil multifonction / Multifunctioneel toestel

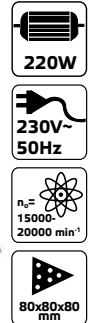

Ref.	P [W]	⊠	EAN
51G330	220	0/8	5902062994950



VERTO

SZLIFIERKA OSCYLACYJNA

Finishing sander / Vibrations Schleifmaschine / Вибрационная шлифовальная машина / Шліфмашина оциляційна / Vibrációs csiszoló / Masina de slefuit oscilatoare / Vibration bruska / Vibration bruska / Vibracijski brusilnik / Ploštuminis šliuoklis / Orbitālā slīpmašīna / Taldlihvija / Вибрационен шлайф / Vibracijska brusilica / Oscilatorna brusilica / Παλμικό τριβείο / Lijadora orbital / Levigatrice orbitale / Disco de limar oscilante / Meuleuse oscillatoire / Oscillatie schuurmachine



- 150W
- 230V~50Hz
- 12000 min⁻¹
- 187x90 mm



Ref.	P [W]	⊠	EAN
516325	150	0/10	5902062513250

STRUG

Planer / Hobel / Рубанок / Гембель / Gyalogép / Gealäu / Hoblík / Hoblík / Skobeljnik / Oblius / Èvele / Höövel / Ренде / Blanjalica / Rende / Πλάνη / Cepillo / Pialla / Garlopa / Rabot / Schaafmachine



- 710W
- 230V~50Hz
- 16000 min⁻¹
- 82mm
- 0-2mm



Ref.	P [W]	⊠	EAN
526607	710	0/6	5902062526076

SZLIFIERKA MIMOŚRODOWA

Orbital sander / Exzenterschleifmaschine / Шлифмашина эксцентриковая / Шліфмашина ексцентрична / Dekopirfűrész / Masina orbitală de șlefuit / Excentrická bruska / Generátor / Vibracijski brusilnik / Ekscentrinis šliuoklis / Slīpmašīna ekscentriskā / Lihvimismasin / Шлайф машина / Vibracion Brusilica / Vibraciona brusilica / Παλμικό τριβείο / Lijadora excéntrica / Levigatrice rotoorbitale / Disco de limar / Meuleuse excentrique / Excenter schuurmachine



- 380W
- 230V~50Hz
- 11000 min⁻¹
- 125mm



Ref.	P [W]	⊠	EAN
516750	380	0/5	5902062517500

SZLIFIERKA TAŚMOWA

Belt sander / Bandschleifmaschine / Шлифмашина ленточная / Шліфмашина стрічкова / Szalagcsiszoló / Strung de șlefuit cu bandă / Pásová bruska / Leštica + prislúsenstvo / Tračni brusilnik / Juostinis šliuoklis / Lentas slīpmašīna / Lintlihvija / Шлайф машина / Trakasta Brusilica / Trakasta brusilica / Λειαντήρας με μιάνα / Lijadora de banda / Levigatrice a nastro / Disco de limar de fita / Meuleuse à bande / Bandschuurmachine



- 730W
- 230V~50Hz
- 260m/min
- 75x457mm
- 75x130mm



Ref.	P [W]	⊠	EAN
516707	730	0/6	5902062517074

NOŽE DO STRUGA

Cutters for planer / Messer für Hobel / Ножи к рубанку / Ножи до рубанка / Gyalogéksek / Cutițe pentru rindea / Nože do hoblíku / Nože na hoblík / Režila za oblič / Peiljai obliui / Èveles naži / Höövliतरad / Nožove za rende / Noževi za blanju / Noževi struga / Λεπίδες πλάνης / Cuchillas para cepillo eléctrico / Lama per pialla / Facas p. Garlopa / Couteaux à rabot / Bladen voor schaaftmachine

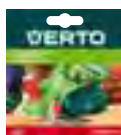

Ref.	L [mm]	for	⊠	EAN
526607-53	82	526607	0/1	5902062526021

FREZARKA

Router / Fräsmaschine / Станок фрезерный / Верстат фрезувальний / Felsőmaró / Trasator / Frézka / Fréza horná + prislúsenstvo / Rezkalnik / Freza / Fréze / Profilfreespinn / Фреза / Godalica / Frezar / Фрѐза / Fresadora / Fresatrice / Fresa / Fraiseuse / Freesmaschine



- 1200W
- 230V~50Hz
- 11500-34000 min⁻¹
- 6mm / 8mm



Ref.	P [W]	⊠	EAN
526713	1200	0/4	5902062058089



OPALARKA

Hot air gun / Sengmaschine / Термофен / Фен / Hőlégfúvó / Pistol de pulverizat aer cald / Opalovací stroj / Teplovzdušná pištol + príslušenstvo / Fen za vroči zrak / Techninis fenas / Fēns celtniecības / Куутарпур / Пистолет за горещ въздух / Fen za vroći zrak / Fen za vrelí vazduh / Πιστόλι θερμού αέρα / Decapador por aire caliente / Termosoffiatore / Soprador de ar quente / Décapeur thermique / Verfstripper



Ref.	P [W]	☒	EAN
51G515	1500	0/10	5902062515155



Ref.	P [W]	☒	EAN
51G517	2000	0/10	5902062515179

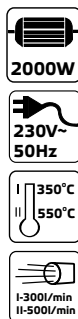

Ref.	P [W]	☒	EAN
51G519	2000	0/10	5902062515193

PILARKA UKOSOWA

Mitre saw / Schrägsäge / Πύλα торцовочная / Пύла-смысно / Gérvágógép / Ferestrău tăiere sub înghi / Pokosová píla / Píla pokosová s laserem / Krožna žaga / Stacionarus pjūklas / Lenka zāģis / Kaldsag / Циркуляр / Kružna Píla / Kruzná testera / Φαλτσοπίριο / Ingletadora / Tronçatrice radiale / Plaina inclinada / Scie à chanfreiner / Verstekzaag

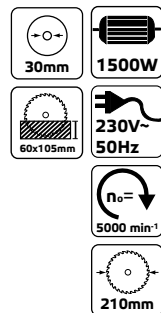

Ref.	P [W]	☒	EAN
52G206	1500	0/1	5902062522061

PILARKA STOŁOWA

Table saw / Tischsäge / Настольная пила / Пíлна верстатна / Asztali fűrés / Ferstrău de banc / Stolní píla / Stolová píla / Namizna žaga / Stacionarus diskinis pjūklas / Galda zāģis / Saepink / Циркуляр настольн / Stolna píla / Stona testera / Επιτραπέζιο πρίοι / Sierra de mesa / Sega circulară da banco / Plaina de mesa / Scie d'établi / Tafelzaag

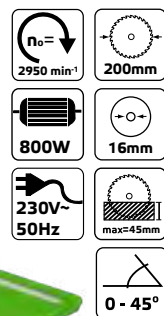

Ref.	P [W]	☒	EAN
52G219	800	0/1	5902062502193



VERTO

KOMPRESOR OLEJOWY

Compressor - lubricated / Ölkompressor / Компрессор масляный / Компрессор оліїний / Compressor / Compresor unsoare / Olejový kompresor / Kompresor / Oljni kompresor / Tepalinis kompresorius / Eļļas kompresors / Kompresor (määritud) / Компресор / Kompresor / Kompresor / Συμπιεστής γρασαρισμένος / Compresor de aceite con propulsión directa / Compresore ad olio / Compresor de óleo / Compresseur à huile / Olie compressor



Ref.	P [W]	⊠	EAN
73K002	1500	0/1	5902062730022



Ref.	L [mm]	⊠	EAN
73K004	1500	0/1	5902062730046

WIERTŁA DO METALU

HSS drills / Metallbohrer / Сверла по металлу / Свєрла по металу / Fémfűró / Burghie pentru metale / Vrtáky do kovu / Vrtáky do kovu / Svedri za kovino / Grăztați metalui / Urbis metalām / Metallpuur / Свєрла за метал / Svrdla za metal / Burģija za metal / Τρυπάνια μετάλλου / Brocas para metal / Punta per metallo / Brocas p. metal / Forêts à métal / Boren voor metaal



Ref.		Ø [mm]	L1	L2	⊠	EAN
60H070	x10	1.0	34	12	10/8000	5902062600707
60H071	x10	1.5	40	18	10/8000	5902062600714
60H072	x10	2.0	49	24	10/8000	5902062600721
60H073	x10	2.5	57	30	10/8000	5902062600738
60H074	x10	3.0	61	33	10/8000	5902062600745
60H075	x10	3.2	65	36	10/8000	5902062600752
60H076	x10	3.5	70	39	10/4000	5902062600769
60H077	x10	4.0	75	43	10/4000	5902062600776
60H078	x10	4.2	75	43	10/4000	5902062600783
60H079	x10	4.5	80	47	10/2500	5902062600790
60H080	x10	5.0	86	52	10/2500	5902062600806
60H097	x10	5.2	86	52	10/2500	5902062600974
60H081	x10	5.5	93	57	10/2500	5902062600813
60H082	x10	6.0	93	57	10/2000	5902062600820
60H083	x10	6.5	101	63	10/1200	5902062600837
60H084	x10	7.0	109	69	10/1200	5902062600844
60H085	x10	7.5	109	69	10/1000	5902062600851
60H086	x5	8.0	117	75	5/600	5902062600868
60H087	x5	8.5	117	75	5/600	5902062600875
60H088	x5	9.0	125	81	5/600	5902062600882
60H089	x5	9.5	125	81	5/600	5902062600899
60H090	x5	10.0	133	87	5/350	5902062600905
60H092	x5	11.0	142	94	5/300	5902062600929
60H094	x5	12.0	151	101	5/300	5902062600943
60H096	x5	13.0	151	101	5/300	5902062600967



Ref.	N	Ø [mm]	⊠	EAN
60H810	x13	1.5-6.5 mm	10/50	5902062025449
60H812	x19	1.0-10.0 mm	10/50	5902062025456
60H814	x25	1.0-13.0 mm	5/20	5902062025463

WIERTŁA DO METALU

HSS drills / Metallbohrer / Свёрла по металлу / Свёрла по металлу / Fémfúró / Burghie pentru metale / Vrtáky do kovu / Vrtáky do kovu / Svedri za kovino / Gražtai metalui / Urbis metālam / Metallpuur / Свёрла за метал / Svrđla za metal / Burgija za metal / Τρυπάνια μετάλλου / Brocas para metal / Punta per metallo / Brocas p. metal / Forêts à métal / Boren voor metaal



x5
HSS
135°
DIN 338

Ref.	Ø [mm]	⊠	EAN
60H000	4, 5, 6, 8, 10	0/100	5902062600004



METAL
x19
HSS
TiN
135°
DIN 338

Ref.	Ø [mm]	⊠	EAN
60H739	1,0 - 10,0	0/10	5902062060907

WIERTŁO STOPNIOWE

Stepped conical bit / Stufenbohrer / Свёрло ступенчатое / Свёрло ступенчатое / Lépcsős fúró / Burghiu lărgitor conic / Stupňovity vrták / Stupňovity vrták / Stopenjski sveder / Pakopinis gražtas / Pakāpjveida urbis / Astmeline puur / Многоствъпално сверло / Stepenasto svrdlo / Konusna - stepenasta burgija / Τρυπάνι διάνοιξης οπίων με διαβάθμιση / Broca con grados / Allargafori a gradino / Broca de graus / Foret étagé / Trapboor

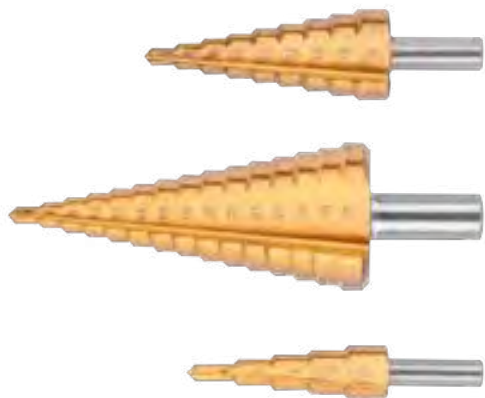

TiN
HSS
PLASTIC
METAL
x3

Ref.	Ø [mm]	⊠	EAN
60H820	4-20; 4-32; 4-12	10/50	5902062507648

WIERTŁA DO BETONU

Concrete drills / Betonbohrer / Свёрла по бетону / Свёрла по бетону / Betonfúró / Burghie pentru beton / Vrtáky do betonu / Vrtáky do betónu / Svedri za beton / Gražtai betonui / Betona urbji / Betoonpuur / Свёрла за бетон / Svrđlo za beton / Burgije za beton / Τρυπάνια µπετόυ / Brocas para hormigón / Punta per calcestruzzo / Brocas p. betão / Forêts pour béton / Boren voor beton



CONCRETE
x5

Ref.	Ø [mm]	⊠	EAN
60H300	4, 5, 6, 8, 10	25/100	5902062603005



CONCRETE
x8

Ref.	Ø [mm]	⊠	EAN
60H302	4, 5, 5, 6, 6, 7, 8, 10 mm	25/100	5902062027498

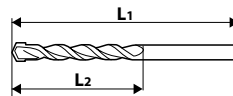

CONCRETE



Ref.	Ø [mm]	L1	L2	⊠	EAN
60H172	4	75	40	100/1500	5902062601728
60H174	6	100	60	200/1000	5902062601742
60H190	6	150	85	50/250	5902062601902
60H176	8	120	80	100/500	5902062601766
60H192	8	250	135	50/200	5902062601926
60H178	10	120	80	100/400	5902062601780
60H194	10	250	135	50/200	5902062601940
60H180	12	150	85	50/250	5902062601803
60H196	12	250	135	50/100	5902062601964

WIERTŁA DO BETONU

Concrete drills / Betonbohrer / Свёрла по бетону / Свёрла по бетону / Betonfúró / Burghie pentru beton / Vrtáky do betonu / Vrtáky do betónu / Svedri za beton / Grqžtai betonui / Betona urbji / Betooinpuur / Свёрла за бетон / Svrdlo za beton / Burgiene za beton / Trúpania metou / Brocas para hormigón / Punte per calcestruzzo / Brocas p. betão / Forêts pour béton / Boren voor beton

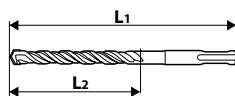
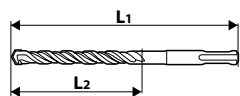

Ref.	Ø [mm]	L1	L2	☒	EAN
60H620	4	110	50	25/300	5902062606204
60H621	5	110	50	25/300	5902062606211
60H622	6	110	50	25/300	5902062606228
60H623	8	110	50	25/300	5902062606235
60H624	10	110	50	25/300	5902062606242
60H625	12	110	50	25/200	5902062606259
60H626	5	160	100	25/200	5902062606266
60H627	6	160	100	25/200	5902062606273
60H628	8	160	100	25/200	5902062606280
60H629	10	160	100	25/200	5902062606297
60H630	12	160	100	25/200	5902062606303
60H631	14	160	100	25/200	5902062606310
60H632	16	160	100	25/100	5902062606327
60H633	6	210	150	25/150	5902062606334
60H634	8	210	150	25/150	5902062606341
60H635	10	210	150	25/150	5902062606358
60H636	12	210	150	25/150	5902062606365
60H637	14	210	150	25/150	5902062606372
60H638	6	260	200	25/100	5902062606389
60H639	8	260	200	25/100	5902062606396
60H640	10	260	200	25/50	5902062606402
60H641	12	260	200	25/100	5902062606419
60H642	14	260	200	25/50	5902062606426
60H643	16	260	200	25/50	5902062606433
60H644	18	260	200	25/50	5902062606440
60H645	16	310	250	0/50	5902062606457
60H647	10	350	290	25/100	5902062606471
60H619	8	400	340	25/50	5902062014962
60H649	10	400	340	25/50	5902062606495
60H650	12	400	340	25/50	5902062606501
60H651	14	400	340	25/50	5902062606518
60H652	16	400	340	25/50	5902062606525
60H664	18	400	340	50/50	5902062014979
60H665	20	400	340	40/40	5902062014986
60H666	22	400	340	40/40	5902062014993
60H667	25	400	340	30/30	5902062015006
60H653	12	450	390	25/50	5902062606532
60H654	14	450	390	0/25	5902062606549
60H655	10	600	540	0/25	5902062606556
60H656	12	600	540	25/25	5902062606563
60H657	14	600	540	0/25	5902062606570
60H658	16	600	540	0/25	5902062606587
60H659	18	600	540	0/25	5902062606594
60H660	20	600	540	0/10	5902062606600
60H668	22	600	540	25/25	5902062015013
60H661	24	600	540	0/10	5902062606617
60H669	28	600	540	20/20	5902062015020



Ref.	Ø [mm]	L1	L2	☒	EAN
60H516	4	110	50	50/300	5902062605160
60H518	5	110	50	50/300	5902062605184
60H520	5	160	100	50/200	5902062605207
60H522	6	110	50	50/300	5902062605221
60H524	6	160	100	50/200	5902062605245
60H526	6	210	150	50/200	5902062605269
60H528	6	260	200	50/200	5902062605283
60H532	8	160	100	50/200	5902062605320
60H534	8	210	150	50/200	5902062605344
60H536	8	260	200	50/200	5902062605368
60H540	10	160	100	50/200	5902062605405
60H542	10	210	150	50/200	5902062605429
60H544	10	260	200	50/200	5902062605443
60H546	10	350	290	25/100	5902062605467
60H548	10	400	340	25/120	5902062605481
60H550	10	600	540	0/50	5902062605504
60H554	12	160	100	50/200	5902062605542
60H556	12	210	150	50/200	5902062605566
60H558	12	260	200	0/100	5902062605580
60H562	12	400	340	0/100	5902062605627
60H566	12	600	540	0/60	5902062605665
60H570	14	210	150	25/100	5902062605702
60H572	14	260	200	0/100	5902062605726
60H576	14	350	290	25/100	5902062605764
60H578	14	400	340	20/80	5902062605788
60H582	14	600	540	0/60	5902062605825
60H588	16	260	200	25/100	5902062605887
60H590	16	310	250	25/50	5902062605900
60H592	16	400	340	0/50	5902062605924
60H594	16	600	540	0/40	5902062605948
60H602	18	600	540	0/40	5902062606020
60H604	20	600	540	0/26	5902062606044
60H606	20	800	740	0/10	5902062606068
60H608	24	600	540	0/20	5902062606082
60H610	24	800	740	0/12	5902062606105

OTWORNICA

Compass saw / Lochsäge / Ножовка / Фреза / Kórkivágó / Ferásträu pentru găuri / Dierovka / Dierovacia píla / Luknjariča / Vienarankis pjūklas / Rokzāģis / Augusaag / Тесен трион / Nareznica / Ručna testera za praviljenje otvora / Πριόν / Sierra de corona / Segga a tazza / Serra para recorte / Scie à guichet / Gatenknipper

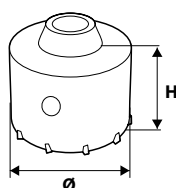

Ref.	Ø [mm]	☒	EAN
60H685	5, 6 x 110 mm + 8, 10, 12 x 160 mm	25/50	5902062027511

Ref.	Ø [mm]	H [mm]	info	☒	EAN
60H265	65	50	M22	15/30	5902062506504
60H280	80	50	M22	15/30	5902062508003

ADAPTER DO OTWORNIC DO BETONU

Hole cutter adaptor / Adapter für Betonstichsägen / Переходник для коронок по бетону / Adapter do vyciřujal'nika po betonu / Adapter fürókalapácshoz / Adaptor p/u sřredelirea sondelar / Adaptér do dřevoek na beton / Stopka SDS + vřták / Adapter SDS / Adapteris karúinai, betonui grežti / Adapters kronvrbim / Augulókúin adapter / SDS Adaptor / SDS adapter / SDS adapter / Avřtáporac ġia potpókórwana ġia mřetón / Adaptador de sierras de corona perforadoras de hormigón / Adattatore per seghe da traforo per calcestruzzo / Adaptador p. serras para recorte p. betão / Adaptateur de scie à ġichet pour béton / Adaptor voor betonknipper



Ref.	typ	info		EAN
60H210	SDS plus	M22	20/80	5902062506559
60H214	SDS Max	M22	0/30	5902062602145

DŁĘTA

Chisel / Beitel / Долово / Зубило / Laposvéső / Daltă / Dlátó / Sekáč plochý SDSplus / Sekáč / Kaltas / Kaltis / Peitel / Сечак SDS Plus 1 / Sjekáč / Sekac / Σμίλη / Formón / Scalpello / Raspador / Ciseau / Beitels

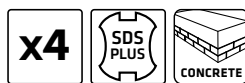
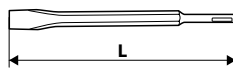

Ref.	L [mm]		EAN
60H240	250	0/20	5902062515049

SZPICAK

Point chisel / Spitzeisen / Доломо-ника / Пробивач / Hegyészéső / Daltă / Špičák / Sekáč špicatý SDSplus / Koničasti sekač / Pincetas / Kaltis spicais / Terava otsaga peitel / Шило / Spica / Spic / Σμίλη αιχμηρού άκρου / Cincel / Punteruola / Cinzel / Poinçon / Puntbeitel

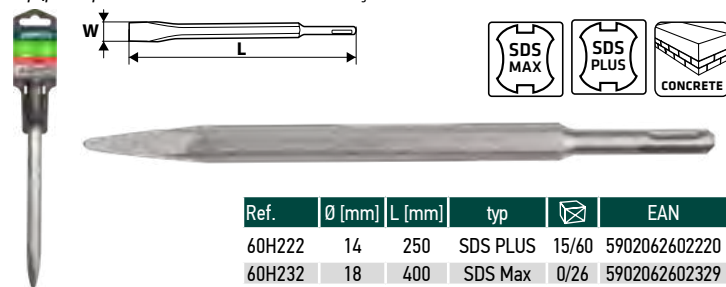

Ref.	info		EAN
60H212	M22	0/30	5902062508058



Ref.	Ø [mm]	L [mm]	typ		EAN
60H222	14	250	SDS PLUS	15/60	5902062602220
60H232	18	400	SDS Max	0/26	5902062602329

DŁĘTO

Chisel / Beitel / Долово / Зубило / Laposvéső / Daltă / Dlátó / Sekáč plochý SDSplus / Sekáč / Kaltas / Kaltis / Peitel / Сечак SDS Plus 1 / Sjekáč / Sekac / Σμίλη / Formón / Scalpello / Raspador / Ciseau / Beitels

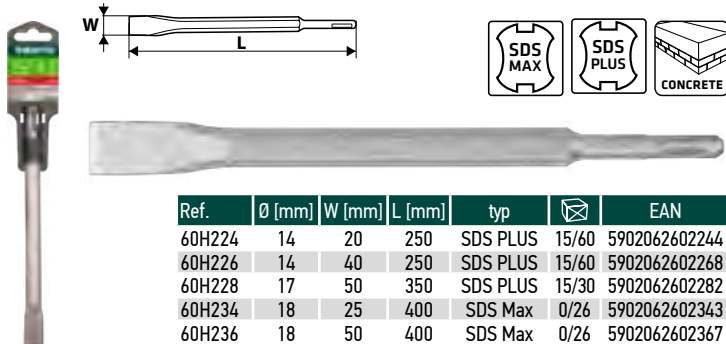

Ref.	Ø [mm]	W [mm]	L [mm]	typ		EAN
60H224	14	20	250	SDS PLUS	15/60	5902062602244
60H226	14	40	250	SDS PLUS	15/60	5902062602268
60H228	17	50	350	SDS PLUS	15/30	5902062602282
60H234	18	25	400	SDS Max	0/26	5902062602343
60H236	18	50	400	SDS Max	0/26	5902062602367

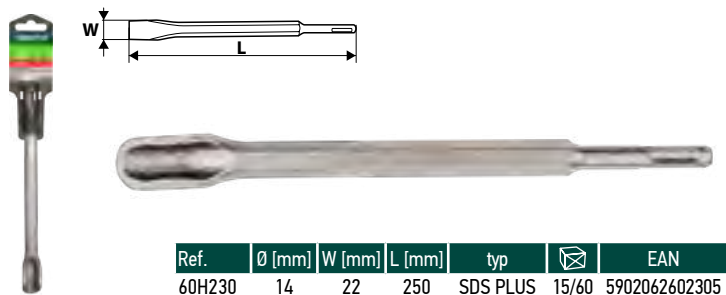

Ref.	Ø [mm]	W [mm]	L [mm]	typ		EAN
60H230	14	22	250	SDS PLUS	15/60	5902062602305

WIERTŁO ŁOPATKOWE DO DREWNA

Wood flat drill bit / Holzbohrer / Сверло перьевое по дереву / Сверло по дереву перо / Lapos fájúró / Burghiu lat pentru lemn / Vřták lopatkový na dřevo / Vřták do dřeva plochý / Sveder za les / Ploščias gražtas medžiui / Spalvu urbis kokam / Lame puidurelli otsik / Средно за дърво / Svrđlo za drvo / Burgija za beton / Τρυπάνια φτερού για διάτρηση ξύλου / Broca de pala para madera / Punta a palettea per legno / Broca de pá p. madeira / Foret à bois plat / Vlakboor voor hout



Ref.	Ø [mm]		EAN
60H804	10, 12, 16, 18, 20, 25	10/40	5902062025487

WIERTŁO DO DREWNA

Wood drill / Holzbohrer / Сверло по дереву / Сверло червячье / Gerendafúró / Burghiu pentru lemn / Vřták do dřeva / Vřták do dřeva / Sveder za les / Medžio gražtas / Urbis koksnei / Puidupuur / Средно за дърво / Svrđlo za drvo / Burgija za drvo / Σπειροειδές τρυπάνι ξύλου / Broca para madera / Punta a elica / Broca para madeira / Foret à bois / Boor voor hout

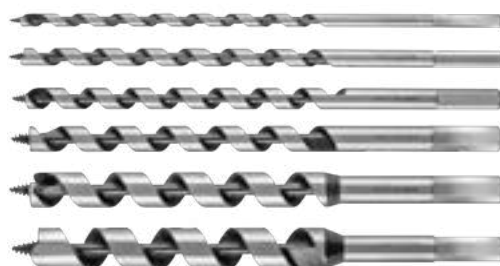

Ref.	Ø [mm]	L [mm]		EAN
60H800	6, 8, 10, 12, 16, 20	230	5/20	5902062507631



Ref.	Ø [mm]		EAN
60H802	4, 5, 6, 8, 10	25/100	5902062025470

VERTO

ZESTAW WIERTEL I BITÓW

Set of drills and bits / Bohrer-set und Bitset / Набор сверл и сменных наконечников / Набор свердел і наконечників-біт / Fúrászár és bit készlet / Set de burghie și bituri / Sada vrtáků a bitů / Súprava vrtákov a nástavcov / Komplet svedrov in bit nastavcov / Gražtų komplektas ir sukimo antgalių / Urbuju komplekts / Puuride ja kruvikeerajate komplekt / Комплект сверделу і бумовое / Set svrdla i bitovi / Komplet burgija i udarača / Σε τρυπανιών και ανταλλακτικών μυτιών / Conjunto de brocas y bits / Set di punte e inserti / Kit de brocas e pontas / Composition de forêts et d'emboûts à étoile et à six branches / Set van boren en bits

◀ 25 mm ▶
x 40

- 3, 3, 4, 4, 5, 5, 6, 6, 7, 7 mm
- PH1 x 2, PH2 x 3, PH3 x 2
- PZ1 x 2, PZ2 x 3, PZ3 x 2
- T10, T15, T20, T25, T27, T30, T40
- H2, H3, H4, H5, H6
- S1, S2 x 2, S3

x 2
16, 22mm

x 5
4, 5, 6, 8, 10 mm

x 5
2, 3, 4, 5, 6 mm

x 5
4, 5, 6, 8, 10 mm

x 1



Ref.	☒	EAN
66H646	0/10	5902062034434

x58

PLASTIC

WOOD

STEEL INOX

◀ 50 mm ▶
x 10

◀ 25 mm ▶
x 40

- 4, 5, 6, 7 mm
- PH1, PH2, PH3
- PZ1, PZ2, PZ3
- T10, T15, T20, T25, T27, T30, T40
- H2, H3, H4, H5, H6
- S1, S2 x 2, S3
- 3, 3, 4, 4, 5, 5, 6, 6, 7, 7 mm
- PH1 x 2, PH2 x 3, PH3 x 2
- PZ1 x 2, PZ2 x 3, PZ3 x 2

x 1

x 1

x 9
5, 6, 7, 8, 9, 10, 11, 12, 13 mm

x 5
4, 5, 6, 8, 10 mm

x 10
2, 2, 3, 3, 4, 4, 4, 5, 5, 5, 6mm

x 5
4, 5, 6, 8, 10 mm



Ref.	☒	EAN
66H648	0/10	5902062034441

x81

PLASTIC

WOOD

STEEL INOX

x 4
32, 38, 45, 54 mm

x 1

x 4
10, 13, 16, 19 mm

x 5
4, 5, 6, 8, 10 mm

x 9
2, 2, 3, 3, 4, 5, 6, 8, 10 mm

x 5
4, 5, 6, 8, 10 mm



◀ 25 mm ▶
x 20

3, 4, 5, 6, 7 mm

PH1, PH2, PH3

PZ1, PZ2, PZ3

T10 T15 T20 T25 T30

H3, H4, H5, H6

x 1



Ref.	☒	EAN
66H650	0/10	5902062034458

x49

PLASTIC

WOOD

STEEL INOX

KOŃCÓWKI WKREŃAKOWE

Driver bits / Einsätze für Schraubendreher / Насадки / Наконечники викруткои / Csavarhúzó betétek / Set biti / Šraubovákóvé nástavce / Skrutkovacie nástavce / Nastavki za izvijače / Atsuktuvo antgaliai / Skrūvgrieža uzgaļi / Kruvikeerajaatsakud / Накрайници за отвёртка / Nastavci za odvijač / Nastavci za odvijač / Καταβιδόμετες / Puntas destornilladoras / Inserti per avvitare / Ponteiros chave de fenda / Embouts de tournevis / Schroevendraaiereinstukken

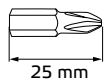

25 mm

CrV

x16



Ref.	info		EAN
66H600	3xPH; 3xPZ; 6xTX; 4xSL	30/60	5902062034335



MAGNETIC

LEFT/STOP/RIGHT

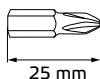

25 mm

CrV

x21

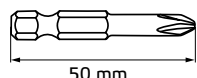

50 mm

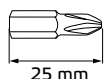

25 mm

CrV

x15



Ref.	info		EAN
66H602	6xPH; 5xPZ; 4xTX	30/60	5902062034342



MAGNETIC

LEFT/STOP/RIGHT



25 mm



30 mm



1/4"



1/4" - 4mm



5,6,7,8,9,10 mm

CrV

x30

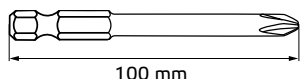

100 mm

CrV

x5



Ref.	info		EAN
66H604	1xPH; 2xPZ; 1xTX; 1xSL	30/60	5902062034359



30 mm

CrV

x31

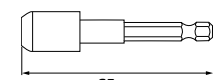

65 mm

MAGNETIC

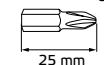

25 mm

CrV

x15



Ref.	info		EAN
66H606	3xPH; 3xPZ; 3xSL; 5xTX	0/60	5902062034366



Ref.	info		EAN
66H619	4xPH; 2xPZ; 7xSL; 9xTX; 8xHEX	50/200	5902062036513

VERTO

KOŃCÓWKI WKREŃAKOWE

Driver bits / Einsätze für Schraubendreher / Наконечники викривача / Csavarhúzó betétek / Set biti / Šroubovákové nástavce / Skrutkovacie nástavce / Nastavki za izvijače / Atsuktuvo antgaliai / Skrivgrieža uzgali / Krivikeeraajatsakud / Накрайніци за отвертка / Nastavci za odvijač / Nastavci za odvijač / Καταβιβόμενες / Puntas destornilladoras / Inserti per avvitare / Ponteiros chave de fenda / Embouts de tournevis / Schroevendraaiereindstukken

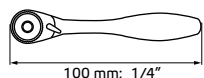

100 mm; 1/4"



25 mm

CrV

x32

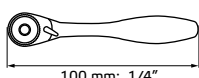

100 mm; 1/4"



25 mm

CrV

6x32



Ref.	info		EAN
66H622	4xPH; 4xPZ; 4xSL; 4xHEX; 7xTX; 7xTT	5/20	5902062034380

Ref.	info		EAN
66H622-6	4xPH; 4xPZ; 4xSL; 4xHEX; 7xTX; 7xTT	1/4	5902062034489



100 mm; 1/4"

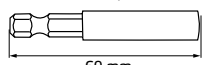

60 mm



25 mm



ADAPTOR



1/4"; HEX 6

CrV

x24

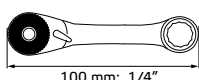

100 mm; 1/4"

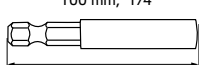

60 mm



25 mm



ADAPTOR



1/4"; HEX 6

CrV

6x24



Ref.	info		EAN
66H624	2xPH; 2xPZ; 2xSL; 4xHEX; 5xTX	5/20	5902062034397

Ref.	info		EAN
66H624-6	2xPH; 2xPZ; 2xSL; 4xHEX; 5xTX	1/4	5902062034496

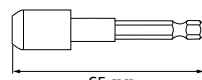

65 mm



25 mm



MAGNETIC

CrV

x32

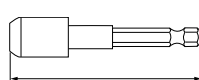

65 mm



25 mm

CrV

6x32



Ref.	info		EAN
66H620	4xPH; 4xPZ; 4xSL; 4xHEX; 7xTX; 7xTT	5/20	5902062034373

Ref.	info		EAN
66H620-6	4xPH; 4xPZ; 4xSL; 4xHEX; 7xTX; 7xTT	1/4	5902062034472

FREZY WIDIOWE

Rotary bit set / Hartmetallfräser / Фрезы профильные / Фрезы профільні, набір / Fenékfűró készlet / Set de dălți rotative / Vidiové kotouče / Súprava hmotých fréz / Gamitura rezkal / Frezos / Frézes kokam / Pöördotsikute komplekt / Фрезы за дърво / Profilni frezeri na dršci / Profilisani frezeri na drsci / Περιστροφικές φρέζες / Broca fresadora de vidia / Frese di vidia / Fresas / Fraises vidia / Roteerfrees



x12

HM



PLASTIC

Ref.	Ø [mm]	⊠	EAN
60H008	6	0/20	5902062070180
60H010	8	0/20	5902062070197

FREZ WIDIOWY

Counter-sink drill with carbid tipped blades / Widi-Fräser / Сверло-фреза / Сверло-фреза / Vidia marofej / Freza cu cap Vidia / Vidiová fréza / Vidiová fréza / Rezkalo vidia / Freza (dengta karbidu) / Fréze / Kahvelifrees / Твердосплавна фреза / Vidija frez / Frezer od vidija-metalna / Τρυπάνι ακλήρου μετάλλου / Broca fresadora de vidia / Frees met hardmetalen dop

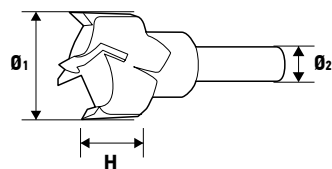

HM



PLASTIC

Ref.	Ø1 [mm]	Ø2 [mm]	H [mm]	n _r max [min ⁻¹]	⊠	EAN
60H825	25	10	13	2500	0/60	5902062526250
60H832	32	10	13	2500	0/60	5902062526328
60H835	35	10	13	2500	1/60	5902062526359

WIERTŁO DO KONFIRMATÓW

Special wood drill / Konfirmatbohrer / Сверло для конфирматов / Сверло до конфирмату / Süllyesztűfűró / Burghiu special pentru lemn / Vrták na konfirmáty / Vrták na konfirmáty / Specialni sveder za les / Specialus medžio gražtas / Koka urbis iedobēm / Spetsialne puidudrell / Бурья спецiална / Srdlo za konfirmate / Burgija za beton / Ειδικό τρυπάνι για ξύλο / Broca para tornillos conformat / Τραπανο speciale / Broca especial / Foret à vis à bois / Boor voor special hout

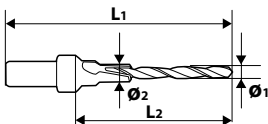

Ref.	Ø1 [mm]	Ø2 [mm]	L1 [mm]	L2 [mm]	⊠	EAN
60H896	4	6	90	60	0/25	5902062608963
60H897	5	7	90	60	0/25	5902062608970

OTWORNICA

Hole saw / Lochsäge / Ножовка / Фреза / Kőrívágó / Ferăstrău pentru găuri / Děrovka / Dierovacía pila / Luknjarnica / Vienarankis pjūklas / Rokzāģis / Augusaag / Тесен трыон / Kružna pila za rupe / Kružna testera za rupe / Πριόνι / Sierra de corona / Segá a tazza / Serra para recorte / Scie à guichet / Gatenknipper

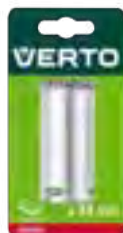
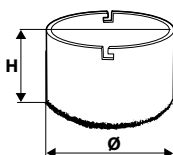

Ref.	Ø [mm]	H [mm]	⊠	EAN
60H902	33	55	10/50	5902062609021
60H904	43	55	10/50	5902062609045
60H906	53	55	10/50	5902062609069
60H908	67	55	10/50	5902062609083
60H910	73	55	10/50	5902062609106

TARCZA DO OTWORNIC

Blades for compass saw / Scheibe für Lochsägen / Диск для ножовок / Диск для фрез / Tárcsa kőrívágóhoz / Disc pentru maşini de găurit / Kotouč pro děrovky / Kotič dierovacej pily / Plošča za luknjarnico / Diskas vienarankiam pjūklui / Griežņu disks / Augusae ketas / Диск за тесни трыони / Ploča za nareznice / Ploča za otvore / Δίσκος για λίμες / Disco de corte para sierras de corona / Flangia di serraggio per seghe a tazza / Disco para Serras para recorte / Disque de scie à guichet / Schijf voor gatenknippers



Ref.	Ø [mm]	⊠	EAN
60H914	33-83	10/50	5902062609144

WIERTŁO PILOTUJĄCE

Pilot drill / Pilotbohrer / Сверло направляющее / Сверло направляющее / Kőzpontosító fűró / Burghiu pilot / Vodicí vrták / Vodiaci vrták / Pilotni sveder / Centruojantis gražtas / Urbja vadikla / Pilotpuur / Направляющее сверло / Srdla za predotvore / Pilot burgija / Τρυπάνι οδηγός / Broca centradora / Punta pilota / Broca de pilotagem / Foret de pilotage / Pilotboor



Ref.	⊠	EAN
60H916	20/100	5902062609168

VERTO

OTWORNICE

Compass saws / Lochsägen / Ножовки / Фрезы / Kőrkinvágók / Ferästraie pentru găuri / Dėrovky / Dierovacie ply / Luknjarice / Vienarankiai pjūklai / Rokzāģi / Augusaed / Τεχνι τριουνη / Nareznice / Ručne testere za pravljenje otvora / Πριόνια / Sierras de corona / Seghe a tazza / Gatenknippers

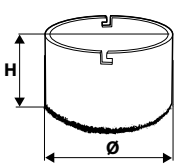

x8

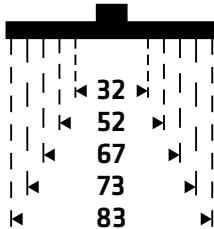

Ref.	Ø [mm]	H [mm]	☒	EAN
60H900	32, 52, 67, 73, 83	55	0/6	5902062609007

OTWORNICE

Compass saws / Lochsägen / Ножовки / Фрезы / Kőrkinvágók / Ferästraie pentru găuri / Dėrovky / Dierovacie ply / Luknjarice / Vienarankiai pjūklai / Rokzāģi / Augusaed / Τεχνι τριουνη / Nareznice / Ručne testere za pravljenje otvora / Πριόνια / Sierras de corona / Seghe a tazza / Gatenknippers

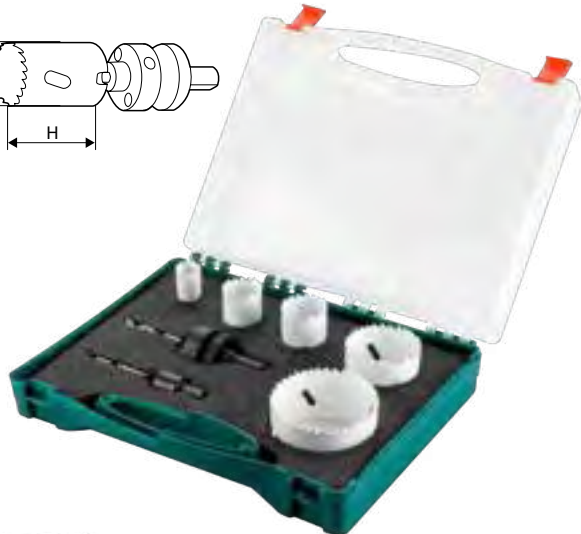
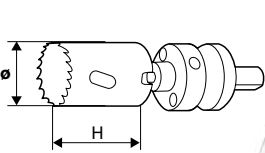

x7



Ref.	Ø [mm]	H [mm]	☒	EAN
60H968	19, 29, 33, 51, 68	38	0/10	59020625567307

OTWORNICE

Compass saws / Lochsägen / Ножовки / Фрезы / Kőrkinvágók / Ferästraie pentru găuri / Dėrovky / Dierovacie ply / Luknjarice / Vienarankiai pjūklai / Rokzāģi / Augusaed / Τεχνι τριουνη / Nareznice / Ručne testere za pravljenje otvora / Πριόνια / Sierras de corona / Seghe a tazza / Gatenknippers

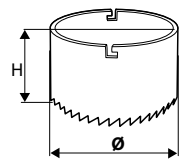

x5



Ref.	Ø [mm]	H [mm]	☒	EAN
60H959	60, 67, 74, 81, 95	30	6/36	5902062071118

OTWORNICA BI-METALOWA

Bi-metal hole saw / Bimetal-Stichsäge / Κοροννα βιμεταλλική / Вихружальник біметалічний / Bi-metal körkinvágó fűró / Ferestrău circular bimetalic / Bimetalová pila děrovka / Bimetalický vykrúžovák / Bi-metalna kronska žaga / Bimetaline karūna / Bimetalā saurumzāģis / Bimetal-augusaed / Bi-metalni sekac-testera / Διμεταλλική ποττροκόρωνα / Sierra de corona bimetalica / Segä da trafoira bi-metallo / Serra para recorte bi-metalica / Scie ä guichet bi-metallique / Bimetalen gatenknipper



6/4 TPI



Ref.	Ø [mm]	☒	EAN
60H921	19	10/180	5902062034694
60H924	22	10/200	5902062034724
60H925	25	10/180	5902062034731
60H928	32	10/100	5902062034762
60H929	35	10/100	5902062034779
60H930	38	10/100	5902062034786
60H931	40	10/100	5902062034793
60H934	51	10/100	5902062034823
60H937	60	10/50	5902062034854
60H938	64	10/50	5902062034861
60H939	67	10/50	5902062034878
60H940	70	10/40	5902062034885
60H941	73	10/40	5902062034892
60H942	83	10/40	5902062034908
60H946	105	2/20	5902062034946

WIERTŁO PILOTUJĄCE

Pilot drill / Pilotbohrer / Сверло направляющее / Свърдло направляющее / Központosító fűró / Burghiu pilot / Vádici vrták / Vodiaci vrták / Pilotni sveder / Centruojantis gražtas / Urbja vadikla / Pilotpuur / Направляющее сверло / Svrla za predovore / Pilot burgija / Τρυπάνι οδηγός / Broca centradora / Punta pilota / Broca de pilotagem / Foret de pilotage / Pilotboor



Ref.	Ø [mm]	L [mm]	☒	EAN
60H952	6,35	75	200/400	5902062034991

ADAPTER DO OTWORNIC BI-METALOWYCH

Arbor for bi-metal hole saw / Adapter für Bimetalstichsägen / Переходник для коронки биметаллической / Adapter для вихружальників біметалічних / Adapter bi-metal körkinvágó fűróhoz / Osie pentru ferestrău circular bi-metal / Adapter do bimetalových děrovok / Adapter na bimetalové vykrúžovaky / Adapter za kronsko žago / Adapteris bimetalinei karūnai / Adapters saurumzāģim / Bimetal-augusaed völl // Adapter za bi-metal testeru / Αντάπτορας για διμεταλλικά ποττροκόρωνα / Adaptador para sierras de corona bimetalicas / Adattatore per sega da trafoira bi-metallo / Adaptador p. sierras para recorte de bi-metal / Adaptateur de scie ä guichet bimetal / Adaptor voor bimetalen gatenknipper



60H950



60H951



Ref.	Ø [mm]	☒	EAN
60H950	14-30	75/150	5902062034977
60H951	> 30	50/100	5902062034984



ZESTAW OTWORNIC

Set of hole cutters / Lochsägensatz / Набор коронок / Набор фрез / Körkivágó készlet / Set carote de găuri / Sada děrovek / Súprava dierovacích pil / Komplet kronskih žag / Grežimo karūnų komplektas / Saurumzāģu komplekts / Kroonpuuride komplekt / Комплект боркорони / Set kruna / Set otvora / Σετ ποττρογύριων / Conjunto de sierras de corona / Kit di segha a tazza / Kit de serras craneanas / Jeu de scies à guichet / Set van gatenzagen



Ref.	Ø [mm]	⊠	EAN
60H953	32, 38, 51, 54	6/36	5902062035004



Ref.	Ø [mm]	⊠	EAN
60H954	19, 22, 25, 29, 32, 35, 38, 44, 51, 57, 64, 76	3/12	5902062035011

TARČA TŃAČA

Cutting disc / Schneidescheibe / Диск пильный / Диск різальний / Vágótárcsa / Disc tăietor / Pilový kotouč / Pilový kotuč / Rezilna plošča / Plovinno diskas / Žaĝa disks / Lõikeketas / Pezecz dysk / Rezna ploča / Ploče za sečenje / Δίσκος κοπή / Disco de corte / Mola da taglio / Disco cortante / Disque de coupage / Snijlschijf

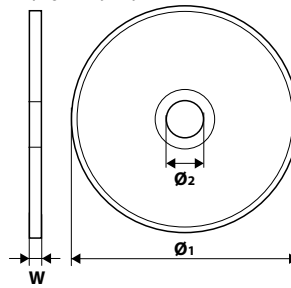

INOX EN12413



Ref.	Ø1 [mm]	Ø2 [mm]	W [mm]	TYP	⊠	EAN
61H401	115	22,2	1,5	41 A46-T-BF	100/400	5902062614018
61H402	125	22,2	1,5	41 A46-T-BF	50/400	5902062614025
61H404	115	22,2	1,0	41 A60-T-BF	100/400	5902062614049
61H405	125	22,2	1,0	41 A60-T-BF	0/400	5902062614056

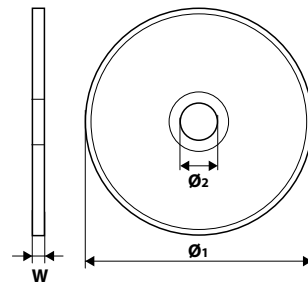

EN12413



Ref.	Ø1 [mm]	Ø2 [mm]	W [mm]	TYP	⊠	EAN
61H530	115	22,2	1,5	41 A46-T-BF	100/400	5902062615305
61H532	125	22,2	1,5	41 A46-T-BF	100/400	5902062615329
61H534	180	22,2	1,6	41 A46-T-BF	50/200	5902062615343
61H536	230	22,2	2,0	41 A46-T-BF	50/100	5902062615367

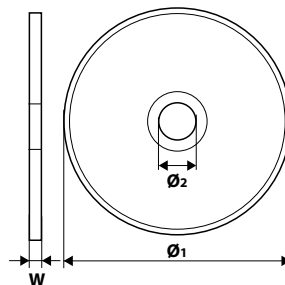

EN12413



Ref.	Ø1 [mm]	Ø2 [mm]	W [mm]	TYP	⊠	EAN
61H515	115	22,2	3,2	41 C30-R-BF	50/200	5902062651150
61H525	125	22,2	3,2	42 C30-R-BF	50/200	5902062651259
61H523	230	22,2	3,2	41 C30-R-BF	10/50	5902062652300

VERTO

TARČA SZLIFIERSKA

Grinding disc / Schleifscheibe / Диск шлифовальный / Диск шлифовальный / Köszörőkör / Inel de șlefuire / Leštící kotouč / Kotuč na stolovú brúsku / Brusilna plošča / Sljivimo diskas / Slipdisk / Lihvimisketas / Диск за шмургел / Brusna ploča / Brusna ploca / Δίσκος λείανσης / Disco para amoladora de banco / Disco per rettificatrice da banco / Disco p. esmerilhar metal / Meule abrasive / Slijpschijf

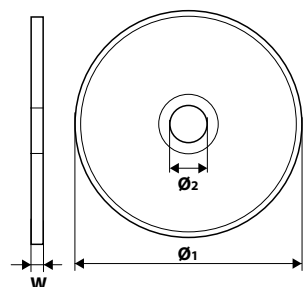

EN12413



Ref.	Ø1 [mm]	Ø2 [mm]	W [mm]	TYP	☒	EAN
61H455	115	22,2	6,0	27 A24-R-BF	30/120	5902062614551
61H465	125	22,2	6,0	27 A24-R-BF	30/120	5902062614650

TARČA DIAMENTOWA

Diamond disc / Diamantscheibe / Диск алмазный / Диск алмазный / Gyémánt-vágótárcsa / Disc de diamant / Diamantový kotouč / Diamantový kotuč / Diamantna plošča / Deimantinis diskas / Dimanta / griezējdiskis / Teemantketas / Диск диамантен / Dijamantna rezna ploča / Dijamantski disk / Διαμαντένιο δίσκοι κοπής / Disco de corte de diamante / Disco di diamante / Disco de diamante / Disque diamanté / Diamantschijf

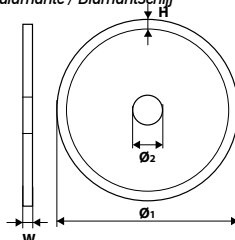

EN13236



Ref.	Ø1 [mm]	Ø2 [mm]	W [mm]	H [mm]	☒	EAN
61H2P1	115	22,2	2,0	6	10/100	5902062664150
61H2P5	125	22,2	2,0	6	10/100	5902062664259
61H2P8	180	22,2	2,0	6	10/50	5902062664181
61H2P9	230	22,2	2,0	6	0/25	5902062664235

TARČA DIAMENTOWA

Diamond disc / Diamantscheibe / Диск алмазный / Диск алмазный / Gyémánt-vágótárcsa / Disc de diamant / Diamantový kotouč / Diamantový kotuč / Diamantna plošča / Deimantinis diskas / Dimanta / griezējdiskis / Teemantketas / Диск диамантен / Dijamantna rezna ploča / Dijamantski disk / Διαμαντένιο δίσκοι κοπής / Disco de corte de diamante / Disco di diamante / Disco de diamante / Disque diamanté / Diamantschijf

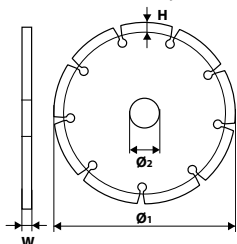

EN13236



Ref.	Ø1 [mm]	Ø2 [mm]	W [mm]	H [mm]	☒	EAN
61H2S1	115	22,2	2,0	7	10/100	5902062660152
61H2S5	125	22,2	2,0	7	10/100	5902062660251
61H2S9	230	22,2	2,0	7	0/25	5902062660237

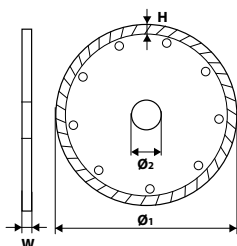

EN13236



Ref.	Ø1 [mm]	Ø2 [mm]	W [mm]	H [mm]	☒	EAN
61H2T1	115	22,2	2,0	7	10/100	5902062662156
61H2T5	125	22,2	2,0	7	10/100	5902062662255
61H2T9	230	22,2	2,0	7	0/25	5902062662231

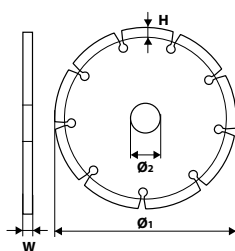

EN13236



Ref.	Ø1 [mm]	Ø2 [mm]	W [mm]	H [mm]	☒	EAN
61H3S1	115	22,2	2,0	7	10/100	5902062070692
61H3S5	125	22,2	2,0	7	10/100	5902062070708
61H3S8	180	22,2	2,0	7	10/50	5902062070715
61H3S9	230	22,2	2,0	7	0/25	5902062070722

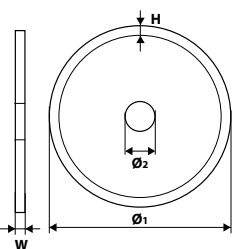

EN13236



Ref.	Ø1 [mm]	Ø2 [mm]	W [mm]	H [mm]	☒	EAN
61H3T1	115	22,2	2,0	7	10/100	5902062070814
61H3T5	125	22,2	2,0	7	10/100	5902062070821
61H3T8	180	22,2	2,0	7	10/50	5902062070838
61H3T9	230	22,2	2,0	7	0/25	5902062070845

TARČA DIAMANTOWA

Diamond disc / Diamantscheibe / Диск алмазний / Диск алмазний / Gyémánt-vágótárcsa / Disc de diamant / Diamantový kotouč / Diamantový kotouč / Diamantna plošča / Deimantinis diskas / Dimanta / griezēdiskis / Teemantketas / Диск диамантен / Dijamantra rezna ploča / Dijamantski disk / Διαμαντένιο δίσκος κοπής / Disco de corte de diamante / Disco di diamante / Disco de diamante / Disque diamanté / Diamantschijf

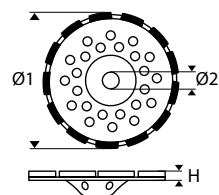

SEGMENT

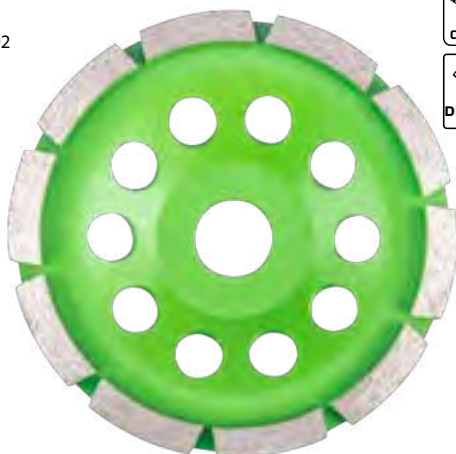

Ref.	Ø1 [mm]	Ø2 [mm]	H [mm]	⊠	EAN
61H434	125	22,2	5	10/20	5902062036520

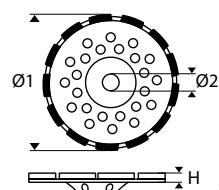

DOUBLE SEGMENT

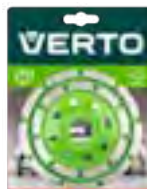
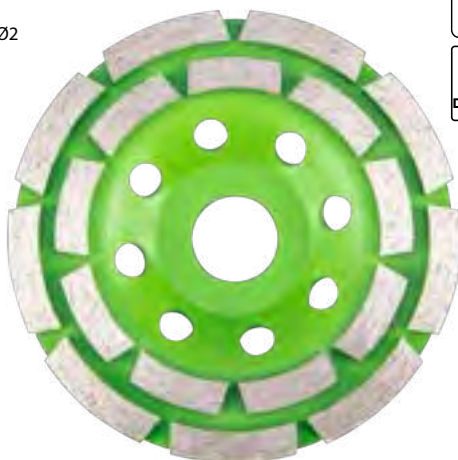

Ref.	Ø1 [mm]	Ø2 [mm]	H [mm]	⊠	EAN
61H436	115	22,2	5	10/20	5902062036537
61H437	125	22,2	5	10/20	5902062036544
61H438	180	22,2	5	5/10	5902062036551

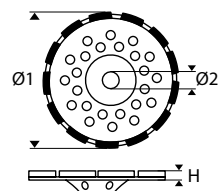

TURBO

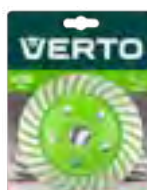
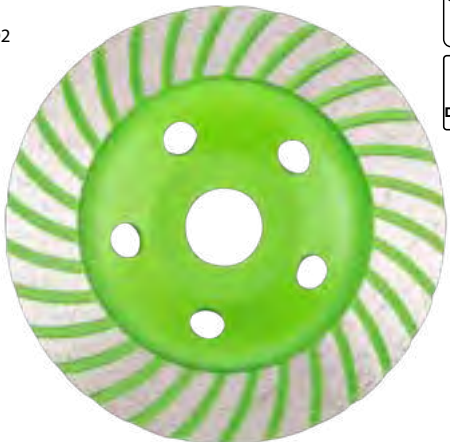

Ref.	Ø1 [mm]	Ø2 [mm]	H [mm]	⊠	EAN
61H440	125	22,2	5	10/20	5902062036568

TARČA DO PILARKI

Circular saw blade / Sägeblatt / Диск пильный / Диск пильный до пилки циркулярной / Körfürészlap / Lamä circularä p/u ferästräu / Pílový kotouč / Pílový kotouč / List za krožno žago / Plovimo diskas pjūkļui / Zāga rīpa / Kreissäeketas / Диск за циркуляр / Kružna Pila / List kruznej testere / Δίσκος κοπής διακοπείου / Disco de corte para sierra circular / Disco per segatrice / Disco p. disco de limar / Disque à scie rotative / Schijf voor slijpmachine

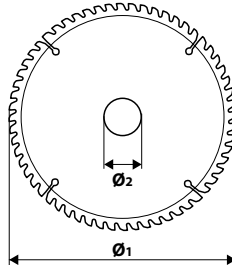

Ref.	↻ xN	Ø1 [mm]	Ø2 [mm]	⊘ [mm]	⊠	EAN
61H190	60	200		30x25,4	0/50	5902062611901
61H194	60	215	30	30x20	0/50	5902062611949
61H108	100	250		30x16	25/25	5902062997463

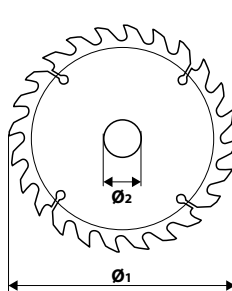

Ref.	↻ xN	Ø1 [mm]	Ø2 [mm]	⊘ [mm]	⊠	EAN
61H114	24	140			50/100	5902062631428
61H116	18	160			50/100	5902062631619
61H118	24	160			50/100	5902062631626
61H120	30	160			50/100	5902062631633
61H105	48	160			50/100	5902062997432
61H106	40	180			50/50	5902062997449
61H107	60	180			50/50	5902062997456
61H121	24	185			0/70	5902062611215
61H123	36	185			0/70	5902062611239
61H125	48	185			0/70	5902062611253
61H122	24	190			0/70	5902062631923
61H124	40	190			0/70	5902062631947
61H126	52	190			0/50	5902062631954
61H128	24	200		30x25,4	0/50	5902062632029
61H130	40	200		30x20	0/70	5902062632043
61H132	60	200		30x16	0/70	5902062632067
61H134	40	250			0/30	5902062632548
61H136	40	300			0/20	5902062633040
61H138	60	300			0/20	5902062633064
61H140	40	315			0/20	5902062633149
61H142	40	350			0/15	5902062633545
61H144	60	350			0/10	5902062633569
61H146	40	400			0/10	5902062634047
61H148	60	400			0/10	5902062634061
61H150	60	450			0/5	5902062634566

VERTO

TARČA SZLIFIERSKA

Grinding disc / Schleifscheibe / Круг шлифовальный / Диск шлифовальный / Köszörőkör / Inel de șlefuire / Lešticí kotouč / Kotúč na stolovú brúsku / Brusilna plošča / Šljifavimo diskas / Slipdisk / Lihvimisketas / Диск за шмурзел / Brusna ploča / Brusna ploča / Δίσκος λείανσης / Disco para ataladora de banco / Disco per rettificatrice da banco / Disco p. esmerilhar metal / Meule abrasive / Slijpschijf

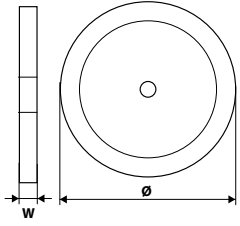

K60

x2

Ref.	Ø [mm]	W [mm]	Ø [mm]	n_0 max [min ⁻¹]	⊠	EAN
61H603	125	16	20x16, 16x12,7	5350	0/15	5902062070777
61H605	150	20	20x16, 16x12,7	4450	6/12	5902062070784
61H607	200	20	20x16, 16x12,7	3300	0/8	5902062070791

TARČA ELASTYCZNA

Elastic disc / Flexible Scheibe / Эластичный диск / Диск эластичный / Elastikus tárcsa / Disc elastic / Elastický kotouč / Elasticí kotúč / Elasticzna plošča / Elastinis diskas / Elastigais disks / Elastne kets / Эластичен диск / Elasticzna ploča / Elasticzna ploča / Ελαστικός δίσκος / Disco elástico / Disco elastico / Disco elástico / Disque flexible / Flexibele schijf

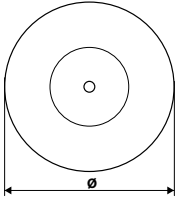

Ref.	Ø [mm]	⊠	EAN
61H730	125	0/10	5902062070876

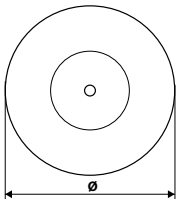

Ref.	Ø [mm]	⊠	EAN
61H740	125	0/50	5902062617408

RZEP SAMOPRZYLEPNY

Hook and loop fastener / Klettverschluss / Самоклеющаяся наклейка / Липучка / Öntapadó tépózár / Scai / Samolepící suchý zip / Suchý zips / Samolepilni velcro / Kibus šljifavimo lapas (varnaleša) / Pašlijmejoša uzlīme / Iseliimuv kinnitus / Самозалепляющ се ренеу / Samolepljivi čičak / Samolepljivi čičak / Βέλκρο / Velcro / Velcro / Elemento autocollante / Adhésif Velcro / Velcroband

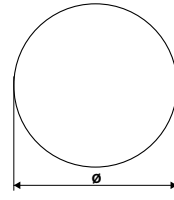

Ref.	Ø [mm]	⊠	EAN
61H702	125	0/20	5902062617026
61H704	150	0/20	5902062617040

FUTRO POLERSKIE

Polishing buff / Plierstoff / Шкурка полировочная / Хутряний полірувальний круг / Polírozó szőrtme / Blană de lustruit / Lešticí kožešina / Lešticí kotúč / Polirno krzno / Poliravimo kailis / Pulešanas audkls / Poleerimiskarusnahk / Кожа за полиране / Krzno za poliranje / Krzno za poliranje / Γούνα στίλβωσης / Caperuzas de lana de oveja / Cuffia per lucidatura / Pele para polir / Fourrure de polissage / Polijst buff

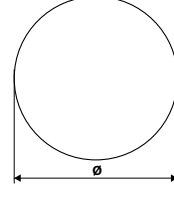

Ref.	Ø [mm]	⊠	EAN
61H706	125	0/10	5902062617064

ГУБКА ПОЛЕРСКА

Polishing sponge / Polierschwamm / Губка полировальная / Губна полирувальна / Polírozó szivacs / Burete lustruitor / Lešticí houba / Lešticí špongia / Polirna goba / Poliravimo kempinė / Pulešanas sūklis / Poleerimiskäsn / Полировочна гъба / Spuzva za poliranje / Polerski sunder / Σπόγγος στίλβωσης / Esponja de pulido / Spugna per lucidatura / Esponja para polir / Mousse de polissage / Polijstspans

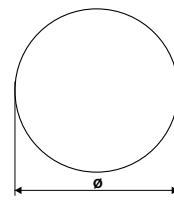

Ref.	Ø [mm]	⊠	EAN
61H709	125	0/10	5902062617095

FILC POLERSKI

Polishing felt / Polierfilz / Фетр полуровочный / Филц полирувальний / Polirkorong / Píslá sľeuvre / Lešticí plst / Filcový disk / Filc za poliranje / Veltinis poliravimui / Filcis pulēšanai / Poleerimisvilt / Диск за полуране / Filc za poliranje / Filc za poliranje / Τσόχα γυαλισματος / Filtro para pulir / Feltro per lucidatura / Filtro para poli / Feutre de polissage / Polijstvit

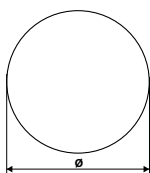

Ref.	Ø [mm]	☒	EAN
61H700	125	5/150	5902062617002

KRAŽKI ŠCIERNE

Abrasive discs / Schleifscheibe / Шлифовальные круги / Круги шлифовальні / Csiszolókorongok / Discuri abrazive / Brusné kroužky / Brúsne kotúče / Brusne plošče / Šlifavimo diskeljai / Slipšanas aplī / Lihvrõngad / Абразивни дискове / Brusni kolutiči / Diskovi za brušenje / Δίσκοι λείανσης / Hoja de lija circular / Dischi abrasivi / Discos abrasivos / Roulette abrasive / Schuurwielen

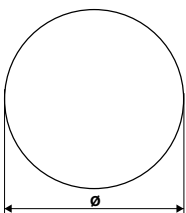

Ref.	Ø [mm]	Info	☒	EAN
63H104	125	K40	0/30	5902062202598
63H106	125	K60	0/30	5902062202604
63H108	125	K80	0/30	5902062202611
63H110	125	K100	0/30	5902062202628
63H112	125	K120	0/30	5902062202635

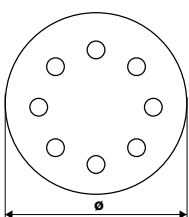

Ref.	Ø [mm]	Info	☒	EAN
63H204	125	K40	0/30	5902062202543
63H206	125	K60	0/30	5902062202550
63H208	125	K80	0/30	5902062202567
63H210	125	K100	0/30	5902062202574
63H212	125	K120	0/30	5902062202581

SZCZOTKA DRUCIANA

Wire brush / Drahtbürste / Щетка проволочная / Щітка по металу / Spidkefe / Perie metal / Drátěný kartáč / Keľa drôtená univerzálna / Žična krtača / Vielinis šepetys / Drašu birste / Traathari / Четка мелена / Četka sa PVC drškom / Četka / Συρμάτινη βούρτσα / Cepillo de alambre / Spazzola metallica / Escova de arame / Brosse métallique / Draadborstel

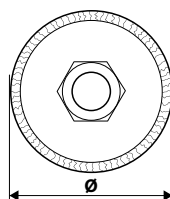

Ref.	Ø [mm]	n _{max} [min ⁻¹]	☒	EAN
62H110	75	12500	6/60	5902062070890
62H111	100	8500	6/30	5902062070906

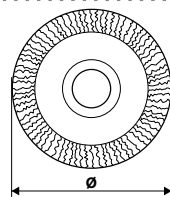

Ref.	Ø [mm]	n _{max} [min ⁻¹]	☒	EAN
62H112	100	12500	6/60	5902062070913
62H121	115	8500	6/60	5902062070920

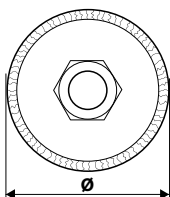

Ref.	Ø [mm]	n _{max} [min ⁻¹]	☒	EAN
62H130	65	12500	6/60	5902062070937
62H131	100	8500	6/18	5902062070944

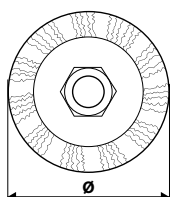

Ref.	Ø [mm]	n _{max} [min ⁻¹]	☒	EAN
62H140	115	8500	6/60	5902062070951
62H141	150	8500	6/30	5902062070968

VERTO

SZCZOTKA DRUCIANA

Wire brush / Drahtbürste / Щетка проволочная / Щітка по металу / Spidkefe / Perie metal / Drátěný kartáč / Kefa drátená univerzálna / Žična krtača / Vielinis šepetys / Drąšu birste / Traathari / Четка мелена / Četka sa PVC drškom / Četka / Συρμάτινη βούρτσα / Cepillo de alambre / Spazzola metallica / Escova de arame / Brosse métallique / Draadborstel

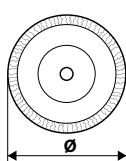
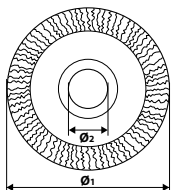

Ref.	Ø1 [mm]	Ø2 [mm]	Ø [mm]	n ₀ max [min ⁻¹]	⊠	EAN
62H210	125	20	16, 12	6500	6/60	5902062070975
62H211	150	32	25, 22, 20, 16, 12	6500	6/30	5902062070982
62H212	200	32	25, 22, 20, 16, 12	6000	6/24	5902062070999

Ref.	Ø [mm]	n ₀ max [min ⁻¹]	⊠	EAN
62H341	24	4500	20/200	5902062071101

SZCZOTKA ŚCIERNA

Abrasive brush / Schleifbürste / Шлифовальная щетка / Щітка дратяна / Drótkefe / Perie abrazivă / Brusný kartáč / Brusna kefka / Brusna ščetka / Ślifawito šepetys / Bliþšanas suka / Lihvimishari / Абразивна четка / Brusna četka / Abrazivna četka / Βούρτσα λειανής / Cepillo lijador / Spazzola abrasiva / Escova abrasiva / Brosse abrasive / Schuurborstel

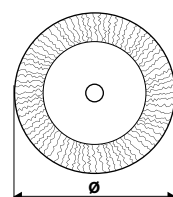
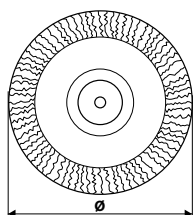

Ref.	Ø [mm]	n ₀ max [min ⁻¹]	⊠	EAN
62H320	75	4500	12/60	5902062071057
62H321	100	4500	12/120	5902062071064

Ref.	Ø [mm]	n ₀ max [min ⁻¹]	⊠	EAN
62H712	75	4500	12/120	5902062071699
62H714	100	4500	12/120	5902062071705

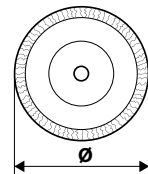
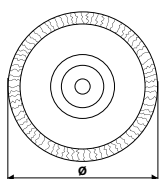

Ref.	Ø [mm]	n ₀ max [min ⁻¹]	⊠	EAN
62H330	50	4500	12/120	5902062071071
62H331	75	4500	12/120	5902062071088

Ref.	Ø [mm]	n ₀ max [min ⁻¹]	⊠	EAN
62H708	65	4500	12/120	5902062071675
62H710	75	4500	12/120	5902062071682

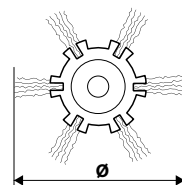

Ref.	Ø [mm]	n ₀ max [min ⁻¹]	⊠	EAN
62H613	25, 37, 50	4500	10/100	5902062070883
62H614	25, 37, 50, 62, 75	4500	10/80	5902062070067

Ref.	Ø [mm]	n ₀ max [min ⁻¹]	⊠	EAN
62H720	100	4500	12/120	5902062071736

ZESTAW SZCZOTEK CZYSZCZĄCYCH

Set of brushes / Satz von Bürsten / Набор щеток / Набор щіток / Tisztítókefe készlet / Set de perii / Sada kartáčů / Súprava kefiiek / Set ščetk / Sepečiu rinkinys / Suku komplekts / Harjade komplekt / Комплект четки / Set četkica za čišćenje / Set četki za čišćenje / Set βούρτσες καθαρισμού / Juego de cepillos de limpieza / Set di spazzole / Kit de escovas / Jeu de brosses / Set van bezems



Ref.	Ø [mm]	📦	EAN
62H700	50, 90, 100, 130	0/27	5902062503763

BRZESZCZOTY DO WYRZYNARKI

Jigsaw blades / Sägeblätter für Schweißsäge / Полотна для лобзика / Полотно пильне до лобзика / Fűrészlapok szűrőfűrészhez / Pánze de ferăstrău de decupat / Pilové listy pro listovou pilu / Listy do priamočiarej píly / Listi za vbočno žago / Pjüklükai siaurapjüklüi / Finierzága asmeni / Tikksae terad / Листове за ажурна дървообработваща машина / Listovi pile za vbočno pilu / Sečiva za ručnu testeru / Приονόλαμες σέγας / Hojas para sierra de calar / Lame per seghetta alternativo / Láminas p. Máquina de entalhar / Lames de scie pour scie sauteuse / Mesbladen voor decoupeerzaag



Ref.	TYP	📦	EAN
64H110	U	20/120	5902062635105
64H210	T	20/120	5902062636102

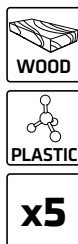

Ref.	TYP	📦	EAN
64H105	U	100/500	5902062635150
64H205	T	100/500	5902062636157

BRZESZCZOTY DO PIŁY CZOŁOWEJ

Blades for front saw / Sägeblätter für Stümsäge / Полотна для фронтальной пилы / Полотно до фронтальної пилки / Fűrészlapok kardfűrészhez / Pánze de ferăstrău frontal / Pilové listy pro čelní pilu / Listy na čelovú pilu / Listi za čelilno žago / Pjüklükai tiesiniam pjüklüi / Frontälä zäga asmeni / otsasea terad / Листове за циркуляр / Listovi pile za čeonu pilu / Sečiva za čeonu testeru / Приονόλαμες για δισκοπρίονα με εμπρόσθια κοπή / Hojas para sierra frontal / Lame per sega universale / Láminas p. serra frontal / Lames de scie pour scie frontale / Mesbladen voor hoofdzaag

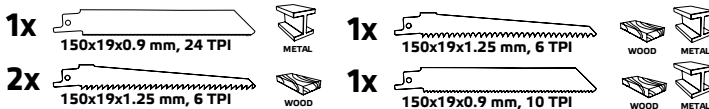

Ref.	📦	EAN
64H120	10/40	5902062506726

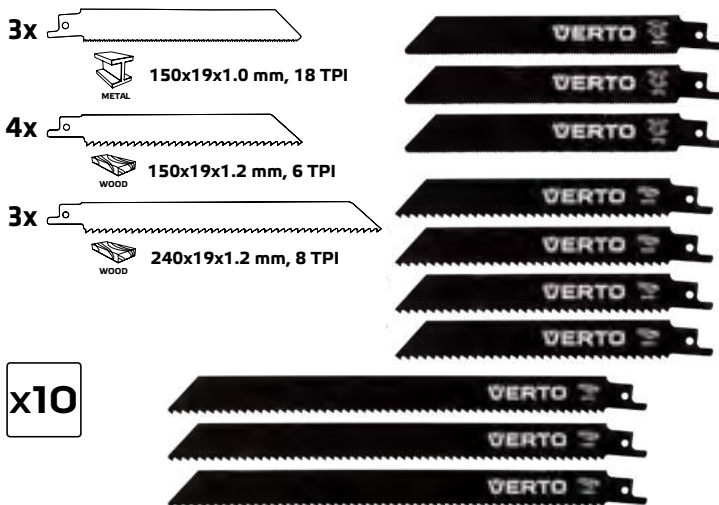

Ref.	📦	EAN
64H130	10/40	5902062506733



Ref.	📦	EAN
64H131	10/40	5902062506740



AKCESORIA DO MINIWIERTARKI

Minidrill accessories / Zubehör für Minibohrmaschine / Аксессуары для мини-дрели / Принадлежности до мини-дрели / Tartozékok minijűrágéphez / Accesorii pentru minibormășină / Príslušenství pro minivrtáčku / Príslušenstvo k minivrtáčke / Pribor za minivrtalnik / Mini suktuvo priedai / Miniurbjmašinas piederumi / Minikruvikeeraja tarvikud / Аксессуары за минипробивна машина / Pribor za minibušilicu / Pribor za mini bušilicu / Αξεσουάρ για μικροδράπανο / Accesorios para mini taladro / Accessori per minitrapano / Accessórios para mini berbequim / Accessoires pour mini perceuse / Accessoires voor boormachine



Ref.	l [mm]	☒	EAN
50G029	3.14	0/18	5902062500298

x100



UCHWYT STOŁOWY DO WIERTARKI

Drilling machine holder / Tischaufnahme für Bohrmaschine / Держатель для дрели с тисками для крепления к столу / Замък верстатниў для дрелию / Fűrógép asztali állvány / Support pentru masina de gaurit / Stolní držák pro vrtáčku / Stolové upínadlo na vrtáčku / Mizno držalo za vrtalnik / Staliniaj spaustuvi, gręztuvui / Urbjmašinas galda turētājs / Lauakinnitus trellile / Настольен держач за пробивна машина / Stolna hvataljka za bušilicu / Stolni držač za bušilicu / Ορθοστάτης δρανάου με σφυκτρία / Soporte de sujeción para taladradora / Supporto con morsetto per trapano / Supporto con morsetto per trapano / Suporte de mesa p. Berbequim / Monture d'établi pour perceuse / Tafelhouder voor boormachine

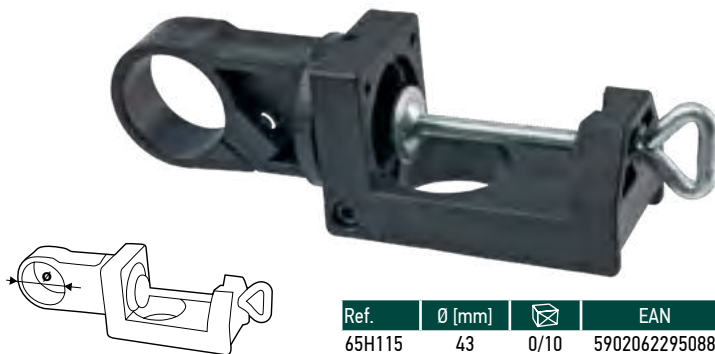

Ref.	Ø [mm]	☒	EAN
65H115	43	0/10	5902062295088

STATYW DO WIERTARKI

Drill stand / Gestell für Bohrmaschine / Держатель для дрели / Штатив до дрелию / Fűróállvány / Stativ pentru masina de gaurit / Stojan na vrtáčku / Stojan na vrtáčku / Stojalo za vrtalnik / Stovas gręztuvui / Urbjmašinas stativs / Stativ trellile / Статив за пробивна машина / Stativ za bušilicu / Σταθιστάτης δρανάου / Soporte para taladradoras / Supporto per trapano / Suporte de berbequim / Bâti pour perceuse / Steun voor boormachine



Ref.	H [mm]	Ø [mm]	Ra [mm]	☒	EAN
65H105	400	43	60	0/10	5902062160737

x71



FREZY

Milling cutters / Fräser / Фрезы / Фрезу / Marókések / Freze / Frézy / Frézy / Rezkala / Frezos / Frēzes / Fresasid / Фрезу / Frezeri / Glodalice, frezeri / Φρέζες / Brocas fresadoras / Frese / Fresas / Fraises / Frezen



x30



Ref.	☒	EAN
50G027	25/50	5902062507426



Ref.	Ø [mm]	☒	EAN
65H106	42	0/10	5902062045669

STATYW DO SZLIFIEREK KĄTOWYCH

Angle grinder support / Gestell für Winkelschleifer / Держатель для угловых шлифмашин / Штатив до шлифмашинки кутъовой (болгарки) / Állvány sarokcsiszolóhoz / Stativ pentru polizor unghiular / Stojan na uhlové brusky / Stojan na uhlovej brusky / Stojalo za kotni brusilnik / Stovas kampiniam šlijvokliui / Lenka slipmašinas stativs / Stativ für Narklihvijale / Статив за ѓлоушлиф / Stativ za kutne brusilice / Stativ za ugaone brusilice / Ορθοστάτης για γωνιακούς λειαντήρες / Suporte para amoladora angular / Supporto per smerigliatrice angolare / Suporte para esmerilhadora de canto / Bâti pour meuleuses d'angle / Steun voor verstekschuurmachines



Ref.	Ø [mm]	☒	EAN
65H110	115, 125	0/10	5902062295071

KLUCZ DO SZLIFIERKI KĄTOWEJ

Angle grinder key / Schlüssel für Winkelschleifer / Ключ для углового шлифовального станка / Ключ до шлифмашинки кутъовой (болгарки) / Kulcs sarokcsiszolóhoz / Cheie pentru polizor unghiular / Klíč pro uhlovou brusku / Klíč do uhlovej brusky / Kľuč za kotni brusilnik / Raktas kampiniam šlijvokliui / Lenka slipmašinas atslēga / Narklihvija vōti / Ключ за шлайф / Kľuč za kutnu brusilicu / Kľuč za ugaonu brusilicu / Κλειδί γωνιακού λειαντήρα / Llave para amoladora angular / Chiave universale per rettificatrice angolare / Chave universal p. disco de limar de canto / Clef universelle à meuleuse d'angle / Sleutel voor verstekschuurmachine

**MULTI
USE**



5-20mm



15-52mm



10-19mm



Ref.	Ø [mm]	☒	EAN
66H320	115-230	12/72	5902062663207

UCHWYT WIERTARSKI

Drill chuck / Bohrfutter / Патрон для дрели / Патрон до дрелю / Fúrótokmány / Mandrină de găurit / Skličidlo pro vrtáky / Slučidlo / Vrtalna glava / Griebtuvas grēžtuvui / Urbjmašinas patrona / Drelli padrun / Патрон за бормашина / Stezna glava-borfuter / Κεντροσφικτής δράπανου / Portabrocas / Manubrio di trapano per chiave / Suporte de berbequim / Mandrin de perçage / Boorhouder

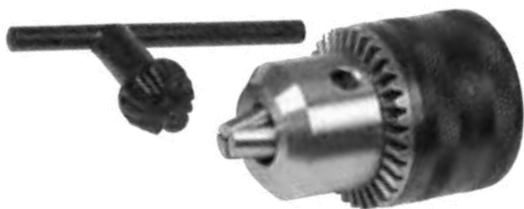

Ref.	Ø	Ra [mm]	☒	EAN
66H108	3/8" x 24	1,0 - 10,0	10/50	5902062160386
66H112	1/2" x 20	1,5 - 13,0	5/40	5902062163127



Ref.	Ø	Ra [mm]	☒	EAN
66H208	3/8" x 24	0,8 - 10,0	10/50	5902062170385
66H212	1/2" x 20	2,0 - 13,0	5/40	5902062173126

KLUCZ DO UCHWYTU WIERTARSKIEGO

Drill chuck key / Bohrfutterschlüssel / Ключ для патрона к дрели / Ключ для патрону до дрелия / Tokmánykulcs / Cheie sfredelie a mandrinei / Kľič ke sklčidlu pro vrtáky / Klíč do sklčidla / Kľuč za vrtalno glavo / Grēžtuvo griebtuvos raktas / Urbjmašinas patronas atslēga / Drelli padruni vōti / Ключ за патрон / Kľuč za borfuter / Kľuč za borfuter / Κλειδί για κεντροσφικτική δράπανου / Llave para mandril / Chiave per manubrio di trapano / Chave p. suporte de berbequim / Clef de mandrin de perceuse / Boorhandvatsleutel



Ref.	Ra [mm]	☒	EAN
66H310	10	20/100	5902062663108
66H313	13	20/100	5902062663139

ADAPTER DO UCHWYTU WIERTARSKIEGO

Drill chuck adaptor / Adapter f. Bohrfutter / Переходник для патрона к дрели / Адаптер до патрону дрелия / Adapter fúrókalapácshoz / Adaptor p/u mandrina de stringere a sfredelului / Adaptér sklčidla na vrtáky / Adaptér na sklčidlo SDS / Adapter za vrtalnik / Adapteris grēžtuvo griebtuvui / Adaptors urbjmašinas patronai / Drellipadruni adapter / SDS Адаптор / SDS adapter za borfuter / Adapter za busilicu / Αντάρτορ τoοκ δράπανου / Adaptador para mandril / Adattatore per presa da trapano / Adaptador de Suporte de berbequim / Adaptateur de mandrin de perceuse / Adaptor voor boorhandvat

SDS



Ref.	gwint	☒	EAN
60H245	1/2" x 20	50/400	5902062602459



VERTO

Wiertła do zapieczonych śrub

Seized bolt extractor set / Bohrer zum Lösen festsitzender Schrauben / Свёрла для прикипевших болтов / Свёрла для прикипевших болтов / Fúrók beégett csavarokhoz / Burghie extractoare pentru şruburi ruginite / Vrtáky do zapečených šroubů / Vrtáky na pretrhnuté skrutky / Svedri za zaklenjene vijake / Surūdijusių varžtų išsuktuvai / Urbji korodētām skrūvēm / Puurid kinnijäänud kruvide eemaldamiseks / Средла за спечени винтове / Svrđla za zaglavljene vijke / Burgije za zarbane zavrtnje / Μύτεες εξωλεικές για κατεστραμμένες βίδες / Brocas para tornillos oxidados / Punte da trapano per viti arrugginite / Brocas para parafusos oxidados / Forets pour vis revêtues / Boren voor vastgelopen schroeven

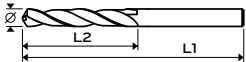

∅ (mm)	L1 (mm)	L2 (mm)	
3,20	49	18	M4
4,20	55	22	M5
5,00	62	26	M6
6,80	74	34	M8
8,50	79	37	M10



Ref.	info	1/100	EAN
08-950	krótkie/short/короткие	1/100	5907558452976

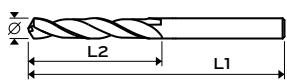

∅ (mm)	L1 (mm)	L2 (mm)	
3,20	65	36	M4
4,20	75	43	M5
5,00	86	52	M6
6,80	109	69	M8
8,50	117	75	M10

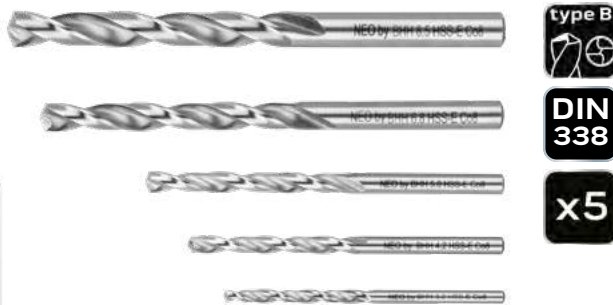

Ref.	info	1/100	EAN
08-955	długie/long/длинные	1/100	5907558452983

Wiertła do nitów

Rivet drill bit set / Nietbohrer / Свёрла для заклепок / Свёрла для заклепок / Fúrók szegecsekhez / Burghie pentru nituri / Vrtáky na nýty / Vrtáky na nity / Svedri za zakovice / Kniedžių išsuktuvai / Urbji kniedēm / Needipuurid / Средла за нитове / Svrđla za zakovice / Burgije za nitne / Μύτεες εξωλεικές για πριτσίνια / Brocas para remaches / Punte da trapano per rivetti / Brocas para rebites / Forets pour rivets / Klinknagelboren

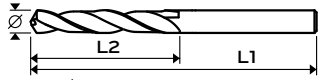

∅ (mm)	L1 (mm)	L2 (mm)
2,50	43	14
3,25	49	18
4,05	55	22
4,85	62	26
6,50	70	31



Ref.	info	1/100	EAN
08-957	krótkie/short/короткие	1/100	5907558459883

Created by: Baidon Drills



POLISH DRILLS since 1908
POLSKIE WIERTŁA od 1908 roku



Wiertła do zgrzewów i spoin

Tack and fusion weld drill bit set / Schweiß- und Verbindungsbohrer / Свёрла для сварных соединений и швов / Свёрла для сварных з'єднань та швів / Fúrók ponthegesztésekhez és varratokhoz / Burghie pentru suduri și îmbinări / Vrtáky na svary / Vrtáky na zvary a spoje / Svedri za zvare in spoje / Sulydomujú ir suduriamujú siüliü gražtai / Urbji metinjumiem un šuvēm / Puurid keevitusõmbluste ja vuukide jaoks / Средла за заварки и швы / Svrđla za varove i spojeve / Burgije za zavarena mesta i spojeve / Τρυπάνια ξηπονταρίσματα / Brocas para soldaduras y juntas / Punte da trapano per saldature e cuciture / Brocas para soldaduras e juntas / Forets pour soudures et joints / Las- en voegboren

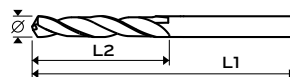

∅ (mm)	L1 (mm)	L2 (mm)
6,00	66	28
8,00	79	37
10,00	89	43



Ref.	info	1/100	EAN
08-958	krótkie/short/короткие	1/100	5907558459890

Filc polerski

Polishing felt / Polierfilz / Фетр полировочный / Фильтр полировальный / Polírkorong / Píslá şlefuire / Leštící plst / Filcový disk / Filc za poliranje / Veltinis poliravimui / Filcis pulēšanas / Poleerimisvilt / Диск за полиране / Filc za poliranje / Filc za poliranje / Τοακά για λείψαση / Fieltro para pulir / Feltro per lucidatura / Feltro para poli / Feutre de polissage / Polijstvlit



Ref.	info	📦	EAN
08-960	Ø 75 mm, 10 mm	1/100	5907558454505
08-961	Ø 125 mm, 10 mm	1/100	5907558454512
08-962	Ø 125 mm, 20 mm	1/100	5907558454529

Tarcza elastyczna

Backing pad / Flexible Scheibe / Эластичный диск / Диск эластичный / Elasztikus tárcsa / Disc elastic / Elastický kotouč / Elastický kotúč / Elastična plošča / Elastinis diskas / Elastīgais disks / Elastne kets / Эластичен диск / Elastična ploča / Elastična ploča / Ελαστικός δίσκος / Disco elástico / Disco elástico / Disque flexible / Flexibele schijf



Ref.	info	📦	EAN
08-977	Ø 75 mm, max 20150 min ⁻¹	1/100	5907558454673
08-968	Ø 125 mm, max 6000 min ⁻¹	1/100	5907558454581

Pad polerski

Foam pad / Polierkissen / Полировальная подушка / Полировальная подушка / Polírozó betét / Tampon de lustruit / Leštící podložka / Leštiaca podložka / Blazinica za poliranje / Poliravimo padas / Pulēšanas spilventiņš / Poleerimisradi / Полирацца гъба / Spružva za poliranje / Подлога за полирање / Σπόγγος στίλβωσης / Almohadilla de pulido / Tampone per lucidatura / Almofada de polimento / Tampon de polissage / Polijstpad



Best used with NEO backing pad 08-968

Ref.	info	📦	EAN
08-963	cutting	1/100	5907558454536
08-964	very hard	1/100	5907558454543
08-965	hard	1/100	5907558454550
08-966	medium	1/100	5907558454567
08-967	soft	1/100	5907558454574



Ref.	info	📦	EAN
08-969	cutting	1/100	5907558454598
08-970	very hard	1/100	5907558454604
08-971	hard	1/100	5907558454611
08-972	medium	1/100	5907558454628
08-973	soft	1/100	5907558454635



Best used with NEO backing pad 08-977

Ref.	info	📦	EAN
08-974	hard	1/100	5907558454642
08-975	medium	1/100	5907558454659
08-976	soft	1/100	5907558454666

Wiertła do metalu

HSS drills / Metallbohrer / Сверла по металлу / Сверла по металлу / Csigafúró készlet / Burghie pentru metale / Vrtáky do kovu / Vrtáky do kovu / Svedri za kovino / Gražtai metalui / Urbis metālam / Metallipuur / Сврџла за метал / Svrđlo za metal / Burgija za metal / Τρυπάνια μετάλλου / Brocas para metal / Set punta a spirale HSS-Tin / Brocas p. metal / Forêts à métal / Boren voor metaal



STEEL

DIN 338

HSS

Ref.	Ø [mm]	N	📦	EAN
60H705	4, 5, 6, 8, 10	x5	25/100	5902062060778



STEEL

DIN 338

HSS

Ref.	Ø [mm]	N	📦	EAN
60H719	1.0, 1.5, 2.5, 3.0, 3.5, 4.0, 4.5, 5.0, 5.5, 6.0, 6.5, 7.0, 7.5, 8.0, 8.5, 9.0, 9.5, 10.0	x19	0/30	5902062060266
60H725	1.0, 1.5, 2.5, 3.0, 3.5, 4.0, 4.5, 5.0, 5.5, 6.0, 6.5, 7.0, 7.5, 8.0, 8.5, 9.0, 9.5, 10.0, 10.5, 11.0, 11.5, 12.0, 12.5, 13.0	x25	0/20	5902062060273



STEEL

DIN 338

HSS



Ref.	Ø [mm]	N	📦	EAN
60H713	1.5, 2.0, 2.5, 3.0, 3.2, 3.5, 4.0, 4.5, 4.8, 5.0, 5.5, 6.0, 6.5	x13	25/100	5902062060242
60H718	2.0, 2.5, 3.0, 3.5, 4.0, 4.5, 5.0, 5.5, 6.0, 7.0, 7.5, 8.0	x13	25/50	5902062060259

Wiertła do drewna

Wood drills / Holzbohrer / Сверла по дереву / Сверла по дереву / Fafúró készlet / Burghie pentru lemn / Vrtáky do dřeva / Vrtáky do dřeva / Svedra za les / Gražtai medžiui / Urbji koksnei / Puidupuurid / Сврџла за дрвресина / Svrđlo za drvo / Brgije za drvo / Τρυπάνια ξύλου / Brocas para madera / Set punte per legno / Brocas p. madeira / Forêts de bois / Boren voor hout



WOOD

x6

HEX

Ref.	Ø [mm]	N	📦	EAN
60H860	10, 12, 16, 18, 20, 25	x6	10/100	5902062060235



CARBON STEEL



WOOD

Ref.	Ø [mm]	N	📦	EAN
60H805	4, 5, 6, 8, 10	x5	30/150	5902062060211
60H808	3, 4, 5, 6, 7, 8, 9, 10	x8	20/100	5902062060228

Wiertła do betonu

Masonry drills / Betonbohrer / Сверла по бетону / Сверла по бетону / Betonfúró készlet / Burghie pentru beton / Vrtáky do betonu / Vrtáky do betónu / Svedri za beton / Gražtai betonui / Betona urbji / Betoonipuur / Сврџла за бетон / Svrđlo za beton / Burgije za beton / Τρυπάνια μπετό / Brocas para hormigón / Set punte da muro / Brocas p. Betão / Forêts pour béton / Boren voor beton



CARBIDE TIP

S4 STEEL



CONCRETE

SDS+

Ref.	Ø [mm]	L [mm]	N	📦	EAN
60H615	5, 6, 8, 10, 12	160	x5	20/40	5902062061065

Wiertła do gazo-betonu

Masonry drills / Betonbohrer / Свёрла по бетону / Свёрдла по бетону / Kőzetfúró készlet / Burghie pentru beton / Vrtáky do betonu / Vrtáky do betónu / Svedri za beton / Grážtai betonui / Betona urbji / Betonipuur / Свёрдла за бетон / Svrđlo za beton / Burgije za beton / Τρυπάνια μπετόν / Brocas para hormigón / Set punte da muro / Brocas p. Betão / Forêts pour béton / Boren voor beton

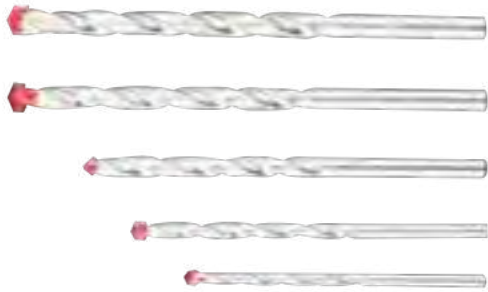

CARBIDE TIP



CONCRETE

Ref.	Ø [mm]	N	Icon	EAN
60H508	3, 4, 5, 6, 7, 8, 9, 10	x8	20/100	5902062060204

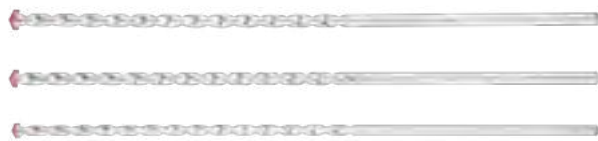

CONCRETE

x3

Ref.	Ø [mm]	L [mm]	Icon	EAN
60H512	8, 10, 12	400	0/50	5902062061034

Wiertła

Drills / Bohrer / Свёрла / Свёрдла / Fúró készlet / Burghie / Vrtáky / Vrtáky / Svedri / Grážtai - püklai / urbji / Puurid / Свёрдла / svrdla / Burgije / Τρυπάνια / Brocas / Punte per forare / Brocas / Forêts / Boren



STEEL



CONCRETE



WOOD

x9

Ref.	Ø [mm]	Icon	EAN
60H009	5, 6, 8	0/50	5902062061430



STEEL



CONCRETE



WOOD

x18

Ref.	Ø [mm]	Icon	EAN
60H018	3, 4, 5, 6, 8, 10	0/20	5902062060884

Otwornice

Holesaws / Lochsägen / Ножовки / Фрезы / Kőrkivágó készlet / Ferăstraie pentru găuri / Děrovky / Dierovacne píly / Luknjarice / Vienarankiai püklai / roközäji / Augusaed / Тесни триони / nareznice / Ručne testere za pravljenje otvora / Пріонія / Sierras de corona / Set sega a tazza / Serra para recorte / Scie à guichet / Gatenknippers

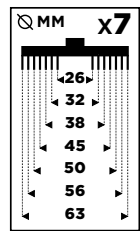

x7



Ref.	Ø [mm]	H [mm]	Icon	EAN
60H971	26 - 63	20	0/50	5902062070029
60H972	26 - 63	43	0/40	5902062070036

Frezy profilowe

Rotary rasp set / Profilfräser / Головки фасонные рашпильные / Свёрдла-фрезы, набор / Csapos köszörűkő / set de raspele rotative / Тваровé frézy / Súprava rotačných fréz / Garnitura za rezkanje profila / Profilavimo frezos / Profila frézés / Pöördrasplite komplet / Profilisani frezeri na drsci / Φρέζες για δράναο / Brocas fresadoras perfiladoras / Set punte con pietra levigatrice / Fresa de perfil / Fraises profilées / Profielrees



WOOD

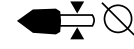

6MM

Ref.	N	Icon	EAN
60H007	x5	0/100	5902062070050

Kamienie szlifierskie

Grindstones / Schleifsteine / Камни шлифовальные / Бруски шлифовальни / Csapos köszörűkő készlet / Set piese minipolizor / Brusné kameny / Súprava brúsnych teliesok / Brusilno kamenje / Šlifavimo akmenys / Šlipakmenų kompleks / Κάιακίβιδα komplet / Μοντιρανα точка / Montirana točka / Set kamenja / Λειανικά πετρώματα / Puntas de amolar / Pietre per rettificatrice / Pedras esmerilhadoras / Meules de rectification / Slijpstenen

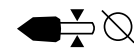

ELECTRO CORUNDUM



Ref.	Ø [mm]	N	Icon	EAN
60H005	6	x5	0/120	5902062070043
60H006	3, 6	x10	12/120	5902062071125

Tarcza diamentowa

Diamond disc / Diamantscheibe / Диск алмазний / Диск алмазний / Gyémánt vágókorong / Disc de diamant / Diamantový kotouč / Diamantový kotúč / Diamantna plošča / Deimantinis diskas / Dimanta griezējdisks / Teemantketas / Диск диамантен / Dijamantna rezna ploča / Dijamantski disk / Διαμαντένιοι δίσκοι κοπής / Disco de corte de diamante / Disco diamantato da taglio / Disco de diamante / Disque diamanté / Diamantschijf



Ref.	Ø [mm]	Type	Icon	EAN
61H315	115x22,2	SEGMENTED	20/100	5902062613158
61H325	125x22,2	SEGMENTED	50/100	5902062613257
61H335	115x22,2	TURBO	20/100	5902062613356
61H345	125x22,2	TURBO	50/100	5902062613455
61H355	115x22,2	CONTINUOUS	0/100	5902062613554

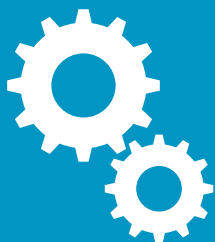

CZĘŚCI ZAMIENNE / SPARE PARTS / ЗАПАСНЫЕ ЧАСТИ

GRAPHITE, GRAPHITE PRO, VERTO, BLACK&DECKER, BOSCH, DEWALT, DREMEL, FATMAX, HESTON, MAC, MAKITA, SKILL, STANLEY, AEG, AL-KO, AMICA, BLACK&DECKER, BOSCH, CELMA, DEXTER, DREMEL, EINHELL, ELECTROLUX, FESTOOL, HILTI, HITACHI, JCB, KARCHER, MACALLISTER, MACTEC, MAKITA, METABO, MILWAUKEE, MODECO, PHILIPS, RAINBOW, RYOBI, SAMSUNG, SKIL, SMEG, STEINEL, ZELMER

W sprzedaży ponad milion części zamiennych do wiodących marek elektronarzędzi.
Over one million spare parts for leading brands of power tools are on sale.
В продаже более миллиона запасных частей к электроинструменту ведущих брендов.



NAPRAWA / REPAIR / РЕМОНТ

Serwis gwarancyjny i pogwarancyjny z wykorzystaniem oryginalnych części.
Warranty and post-warranty service using original parts.

Гарантийное и послегарантийное обслуживание с использованием оригинальных запасных частей.

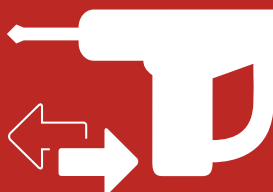

WYPOŻYCZALNIA / RENTAL / ПУНКТ ПРОКАТА

Wysokiej jakości elektronarzędzia i sprzęt budowlany dostępny w wybranych Stacjach Obsługi Narzędzi.

High quality of power tools and construction equipment available in selected Tool Stations.

Высококачественный электроинструмент и строительное оборудование в выбранных Станциях обслуживания инструмента.



USŁUGI / SERVICES / УСЛУГИ

Regeneracja akumulatorów, przedłużanie gwarancji, kalibracja kluczy dynamometrycznych, ostrzenie i inne...

Regeneration of batteries, extension of warranty, calibration of torque wrenches, sharpening and other services...

Регенерация аккумуляторных батарей, продление гарантийного срока, калибровка динамометрических ключей, заточка и прочее.

Aktualną listę serwisów gwarancyjnych i pogwarancyjnych znajdziesz na gtxservice.pl

The current list of warranty and post warranty services you will find on gtxservice.com

Текущий список гарантийных и послегарантийных услуг вы найдете на gtxservice.com





CZĘŚCI ZAMIENNE

SPARE PARTS

ЗАПАСНЫЕ ЧАСТИ

Szczotki węglowe Frame:

- ▶ sprawdzona jakość - za rozsądną cenę
- ▶ wysoka jakość – produkcja z najlepszej jakości grafitu
- ▶ pełna kompatybilność z oryginałem - potwierdzona testami

Frame carbon brushes:

- ▶ proven quality - at a reasonable price
- ▶ high quality - best quality graphite used for production
- ▶ full compatibility with original - proven with tests

Угольные щетки Frame:

- ▶ проверенное качество – по разумной цене
- ▶ высокое качество – продукция из высококачественного графита
- ▶ полная совместимость с оригиналом – подтвержденная испытаниями



Szczotki węglowe do produktów wielu marek / Carbon brushes for many brands / Угольные щетки для многих марок:

Graphite, Graphite Pro, Verto, Black&Decker, Bosch, Dewalt, Dremel, Fatmax, Heston, Mac, Makita, Skill, Stanley, Aeg, Al-Ko, Amica, Black&Decker, Bosch, Celma, Dexter, Dremel, Einhell, Electrolux, Festool, Hilti, Hitachi, Jcb, Karcher, Macallister, Mactec, Makita, Metabo, Milwaukee, Modeco, Philips, Rainbow, Ryobi, Samsung, Skil, Smeg, Steinel, Zelmer

Lista dostępności szczotek węglowych - zeskanuj kod QR lub wejdź na gtxservice.pl / List of carbon brushes availability - scan the QR code or visit gtxservice.pl / Список наличия угольных щеток - отсканируйте QR-код или перейдите на gtxservice.pl



ZESTAW NAPRAWCZY Hybrid Battery

REPAIR KIT Hybrid Battery

РЕМОНТНЫЙ НАБОР Hybrid Battery



Zestawy naprawcze do regeneracji akumulatorów Ni-Cd lub Ni-MH poprzez wymianę technologii ogniw na Li-Ion.

Repair kits for the regeneration of Ni-Cd or Ni-MH batteries through the exchange of cell technology on Li-Ion.

Ремонтные наборы для регенерации аккумуляторных батарей Ni-Cd или Ni-MH благодаря замене технологии элементов на Li-Ion



Więcej... / More... / Более...



Ref.	Str.	Ref.	Str.	Ref.	Str.	Ref.	Str.	Ref.	Str.	Ref.	Str.	Ref.	Str.
08-950	132	52G552	101	55H301	67	55H723	86	55H870	87	55H954	83	56H070	81
08-955	132	52G567	103	55H302	67	55H724	86	55H871	87	55H955	83	56H072	81
08-957	132	52G573	102	55H303	67	55H725	86	55H872	87	55H956	83	56H074	81
08-958	132	52G574	102	55H304	67	55H726	86	55H873	87	55H957	86	56H500	92
08-960	133	52G575	102	55H305	67	55H728	86	55H874	87	55H958	86	56H501	92
08-961	133	52G584	105	55H306	67	55H729	86	55H875	87	55H959	86	56H502	92
08-962	133	52G584-71	105	55H307	67	55H730	86	55H876	87	55H960	86	56H503	92
08-963	133	52G584-73	105	55H308	67	55H731	86	55H877	87	55H961	86	56H504	92
08-964	133	52G607	112	55H309	67	55H732	86	55H878	87	55H962	86	56H505	92
08-965	133	52G607-53	112	55H310	67	55H733	86	55H879	87	55H963	86	56H506	92
08-966	133	52G670	59	55H311	67	55H734	86	55H880	87	55H964	86	56H507	92
08-967	133	52G671	59	55H312	67	55H736	86	55H881	87	55H965	86	56H508	92
08-968	133	52G672	59	55H313	67	55H737	86	55H882	87	55H966	87	56H509	92
08-969	133	52G673	59	55H314	67	55H738	86	55H884	86	55H967	87	56H510	92
08-970	133	52G682	111	55H315	67	55H739	86	55H885	86	55H968	87	56H511	92
08-971	133	52G684	111	55H316	67	55H740	86	55H886	86	55H969	87	56H512	93
08-972	133	52G713	112	55H317	67	55H741	86	55H887	86	55H970	87	56H513	93
08-973	133	558G020-SET2	29	55H320	67	55H742	86	55H888	86	55H971	87	56H514	93
08-974	133	55H010	64	55H350	68	55H743	84	55H889	86	55H972	87	56H515	93
08-975	133	55H013	64	55H351	68	55H744	84	55H890	86	55H973	87	56H516	93
08-976	133	55H014	64	55H352	68	55H745	84	55H891	86	55H974	87	56H517	93
08-977	133	55H015	64	55H353	68	55H746	84	55H892	86	55H975	87	56H518	93
50G027	130	55H016	64	55H354	68	55H747	86	55H893	86	55H976	87	56H519	93
50G028	130	55H017	64	55H355	68	55H748	86	55H894	86	55H977	87	56H520	93
50G029	130	55H018	64	55H356	68	55H749	86	55H896	86	55H978	87	56H521	93
50G139	105	55H019	64	55H357	68	55H750	86	55H897	86	55H979	87	56H522	93
50G273	106	55H020	64	55H358	68	55H751	86	55H898	86	55H980	83	56H523	93
50G290	106	55H021	64	55H359	68	55H752	86	55H899	86	55H981	83	56H524	93
50G291	106	55H022	64	55H360	68	55H753	86	55H900	86	55H982	83	56H525	93
50G292	106	55H024	64	55H361	68	55H754	88	55H901	86	55H983	83	56H526	93
50G293	106	55H025	64	55H362	68	55H755	88	55H902	86	55H984	83	56H527	93
50G365	108	55H026	64	55H363	69	55H756	88	55H903	86	55H985	83	56H528	93
50G387	108	55H027	64	55H364	69	55H757	88	55H904	86	55H986	83	56H529	93
50G390	108	55H029	64	55H365	69	55H758	88	55H905	86	55H987	83	56H530	94
50G490	101	55H030	64	55H366	69	55H759	88	55H906	86	55H988	83	56H531	94
50G490-134	101	55H031	64	55H367	69	55H760	88	55H907	86	55H989	83	56H532	94
50G490-30	101	55H033	64	55H368	69	55H761	88	55H908	86	55H990	83	56H533	94
50G491	101	55H034	64	55H369	69	55H762	88	55H909	86	55H991	83	56H534	94
50G515	107	55H035	64	55H370	69	55H763	87	55H910	86	55H992	84	56H535	94
50G519	107	55H036	64	55H371	69	55H764	87	55H911	86	55H995	91	56H536	94
50G519K	107	55H038	64	55H372	69	55H765	87	55H912	85	55H996	92	56H540	93
50G528	108	55H039	64	55H373	69	55H766	87	55H913	85	56H002	81	56H541	93
50G539	108	55H040	64	55H374	69	55H767	87	55H914	85	56H004	81	56H542	93
51G014	110	55H050	70	55H375	69	55H768	87	55H915	85	56H006	80	56H543	93
51G053	109	55H051	70	55H376	69	55H779	84	55H916	85	56H008	80	56H550	91
51G061	109	55H052	70	55H377	69	55H780	84	55H917	85	56H010	82	56H551	91
51G075	109	55H054	70	55H540	67	55H781	84	55H918	85	56H012	82	56H552	91
51G091	109	55H055	70	55H545	77	55H787	88	55H919	85	56H013	82	56H553	91
51G096	109	55H056	70	55H546	77	55H788	88	55H920	85	56H014	82	56H554	91
51G098	109	55H057	70	55H547	77	55H789	88	55H921	85	56H030	88	56H555	91
51G203	109	55H058	70	55H548	77	55H790	88	55H922	85	56H031	88	56H556	91
51G325	112	55H059	70	55H570	77	55H791	88	55H923	85	56H032	88	56H560	94
51G330	111	55H060	70	55H572	77	55H797	88	55H924	85	56H033	88	56H562	94
51G425	110	55H061	70	55H574	77	55H798	88	55H925	85	56H034	88	56H600	95
51G427	110	55H062	70	55H576	77	55H799	88	55H926	85	56H035	88	56H602	95
51G452	110	55H063	70	55H600	76	55H800	88	55H927	85	56H036	88	56H604	95
51G515	113	55H064	70	55H601	76	55H801	88	55H928	85	56H037	88	56H606	95
51G517	113	55H065	70	55H603	76	55H823	85	55H929	85	56H038	88	56H608	95
51G519	113	55H066	70	55H604	76	55H824	85	55H930	96	56H039	88	56H610	95
51G707	112	55H067	70	55H605	76	55H825	85	55H931	96	56H040	88	56H612	96
51G726	110	55H068	70	55H606	76	55H826	85	55H932	96	56H041	88	56H614	96
51G750	112	55H069	71	55H607	76	55H827	85	55H933	83	56H042	88	56H616	96
52G056	111	55H070	71	55H608	76	55H850	84	55H934	83	56H043	88	56H620	97
52G058	111	55H071	71	55H610	76	55H851	84	55H935	83	56H044	88	56H622	97
52G064	111	55H072	71	55H611	76	55H852	84	55H936	83	56H045	88	56H630	97
52G106	108	55H073	71	55H666	77	55H853	84	55H937	83	56H046	88	56H631	97
52G166	111	55H074	71	55H685	77	55H854	84	55H938	83	56H047	89	56H632	97
52G206	113	55H075	71	55H686	77	55H855	84	55H939	83	56H048	89	56H633	97
52G219	113	55H076	71	55H687	77	55H856	84	55H940	83	56H049	89	56H650	97
52G300	102	55H077	71	55H688	77	55H857	84	55H941	83	56H050	79	56H655	97
52G311	103	55H078	71	55H689	77	55H858	84	55H942	83	56H051	79	56H700	39
52G401	104	55H079	72	55H691	77	55H859	84	55H943	83	56H052	79	56H701	39
52G402	104	55H080	72	55H692	77	55H860	86	55H944	83	56H053	80	56H702	39
52G403	104	55H081	72	55H693	77	55H861	86	55H945	83	56H054	80	56H703	39
52G441	103	55H082	72	55H694	77	55H862	86	55H946	83	56H055	80	56H704	39
52G449	103	55H084	72	55H695	76	55H863	86	55H947	83	56H056	80	56H710	39
52G500	104	55H085	72	55H697	77	55H864	86	55H948	83	56H057	80	56H750	21
52G502	105	55H086	64	55H698	77	55H865	86	55H949	83	56H061	80	56H751	21
52G502-17	105	55H088	64	55H699	77	55H866	86	55H950	83	56H062	80	56H752	21
52G505	104	55H089	64	55H720	86	55H867	87	55H951	83	56H063	80	56H753	21
52G550	101	55H090	64	55H721	86	55H868	87	55H952	83	56H064	80	56H754	21
52G551	101	55H300	67	55H722	86	55H869	87	55H953	83	56H065	81	56H755	21

Ref.	Str.	Ref.	Str.	Ref.	Str.	Ref.	Str.	Ref.	Str.	Ref.	Str.	Ref.	Str.
56H756	21	57H055	63	57H268	70	57H450	65	57H630	75	57H835	83	57H962	91
56H760	21	57H056	63	57H269	73	57H454	65	57H632	75	57H836	83	57H963	91
56H761	21	57H056-5	63	57H270	73	57H456	65	57H634	75	57H837	83	57H964	91
56H762	21	57H058	63	57H271	73	57H458	65	57H636	75	57H838	83	57H965	91
56H763	21	57H058-5	63	57H272	73	57H460	65	57H638	75	57H839	83	57H966	91
56H764	21	57H062	63	57H273	73	57H462	65	57H640	75	57H840	83	57H968	91
56H765	21	57H062-5	63	57H274	73	57H464	65	57H642	75	57H841	83	57H971	91
56H766	21	57H064	63	57H275	73	57H466	65	57H644	75	57H842	83	57H972	91
56H767	21	57H066	63	57H276	73	57H470	65	57H645	75	57H843	83	57H973	91
56H811	61	57H066-5	63	57H278	67	57H472	65	57H646	75	57H844	83	57H974	91
56H812	61	57H086	63	57H279	67	57H474	65	57H650	76	57H845	83	57H975	91
56H813	61	57H088	63	57H280	67	57H476	65	57H652	76	57H850	82	57H976	91
56H820	61	57H089	63	57H284	67	57H478	65	57H654	76	57H851	82	57H977	91
56H822	61	57H090	63	57H285	67	57H480	65	57H654	76	57H852	82	57H978	92
56H824	61	57H110	63	57H286	67	57H482	65	57H656	76	57H853	82	57H979	92
56H825	62	57H112	63	57H287	67	57H484	65	57H658	76	57H854	82	57H981	92
56H827	62	57H114	63	57H288	67	57H486	65	57H660	76	57H855	82	57H982	92
56H829	62	57H116	63	57H289	67	57H488	65	57H662	76	57H856	82	57H983	92
56H830	62	57H118	63	57H290	67	57H490	65	57H664	76	57H860	84	57H986	92
56H833	62	57H120	63	57H291	67	57H492	65	57H666	76	57H870	74	57H987	92
56H835	62	57H122	63	57H292	67	57H494	65	57H668	76	57H871	75	57H989	92
56H839	62	57H123	63	57H293	67	57H506	66	57H670	76	57H872	75	57H990	92
56H840	62	57H124	63	57H294	67	57H508	66	57H672	76	57H874	75	57H991	91
56H847	62	57H126	63	57H295	67	57H510	66	57H674	76	57H875	76	57H992	91
56H849	62	57H128	63	57H296	67	57H514	66	57H676	76	57H876	76	57H993	91
56H870	62	57H130	63	57H297	67	57H516	66	57H678	76	57H877	76	57H994	91
56H871	62	57H132	63	57H298	67	57H518	66	57H679	76	57H878	76	57H995	91
56H872	62	57H134	63	57H299	67	57H520	66	57H680	76	57H879	76	57H996	94
56H880	62	57H136	63	57H300	67	57H524	66	57H681	76	57H880	76	58G000	14
56H881	62	57H138	63	57H312	65	57H526	66	57H682	76	57H881	76	58G000-SET1	28
56H882	62	57H140	63	57H313	65	57H528	66	57H684	76	57H884	75	58G001	27
56H900	62	57H142	63	57H314	65	57H530	66	57H686	76	57H886	75	58G002	27
56H901	62	57H144	63	57H316	65	57H532	66	57H690	78	57H887	75	58G003	17
56H902	62	57H146	63	57H318	65	57H534	66	57H700	78	57H888	75	58G004	27
56H903	62	57H148	63	57H320	65	57H540	66	57H705	78	57H889	76	58G006	14
56H904	62	57H150	63	57H322	65	57H542	66	57H706	78	57H890	76	58G006-SET2	28
56H905	62	57H152	63	57H328	65	57H544	66	57H707	78	57H900	90	58G007	22
57G100	60	57H154	63	57H330	65	57H546	66	57H708	78	57H901	90	58G008	19
57H010	63	57H156	63	57H332	65	57H556	68	57H711	78	57H902	90	58G009	16
57H012	63	57H158	63	57H334	65	57H557	68	57H712	78	57H903	90	58G010	15
57H014	63	57H162	63	57H336	65	57H558	68	57H713	78	57H904	90	58G011	18
57H014-10	63	57H164	63	57H338	65	57H559	68	57H714	78	57H905	90	58G012	16
57H015	63	57H166	63	57H342	65	57H560	68	57H715	78	57H906	90	58G013	17
57H016	63	57H196	64	57H344	65	57H561	68	57H717	78	57H907	90	58G014	17
57H018	63	57H198	64	57H346	65	57H562	68	57H718	78	57H908	90	58G015	29
57H018-10	63	57H199	64	57H350	66	57H563	68	57H719	78	57H909	90	58G016	29
57H020	63	57H200	64	57H351	66	57H564	68	57H720	78	57H910	90	58G017	18
57H020-10	63	57H210	69	57H352	73	57H565	68	57H722	78	57H911	90	58G018	15
57H022	63	57H211	73	57H354	73	57H566	68	57H724	78	57H912	90	58G019	15
57H022-10	63	57H212	73	57H356	73	57H567	68	57H725	78	57H913	90	58G019-SET1	28
57H023	63	57H214	73	57H358	73	57H570	66	57H730	78	57H914	90	58G020	15
57H023-10	63	57H216	73	57H360	73	57H572	66	57H733	78	57H915	90	58G021	29
57H024	63	57H218	73	57H362	73	57H576	65	57H738	78	57H916	90	58G022	14
57H024-10	63	57H220	73	57H364	73	57H577	65	57H739	65	57H917	90	58G022-AD	14
57H026	63	57H222	73	57H366	73	57H578	65	57H740	65	57H918	90	58G022-PS15	29
57H026-10	63	57H224	73	57H368	73	57H581	78	57H741	65	57H919	90	58G022-SET2	28
57H028	63	57H226	73	57H370	73	57H582	78	57H745	74	57H920	90	58G023	19
57H028-10	63	57H228	73	57H372	73	57H583	78	57H746	66	57H922	90	58G023-732	19
57H030	63	57H230	73	57H400	65	57H585	78	57H754	90	57H924	90	58G024	16
57H030-10	63	57H232	73	57H404	65	57H587	78	57H755	90	57H926	90	58G025	21
57H032	63	57H234	73	57H406	65	57H589	79	57H759	89	57H928	90	58G026	17
57H032-10	63	57H236	73	57H408	65	57H591	79	57H760	89	57H930	90	58G027	16
57H034	63	57H238	73	57H410	65	57H592	79	57H760-25	90	57H932	90	58G029	24
57H034-10	63	57H240	73	57H411	65	57H596	79	57H761	89	57H934	90	58G030	23
57H036	63	57H242	73	57H412	65	57H598	79	57H762	89	57H936	90	58G031	26
57H036-10	63	57H244	73	57H414	65	57H599	79	57H763	89	57H938	90	58G032	24
57H038	63	57H245	73	57H416	65	57H600	79	57H764	89	57H940	90	58G033	23
57H038-10	63	57H250	74	57H418	65	57H601	79	57H765	89	57H944	90	58G034	25
57H040	63	57H251	73	57H419	65	57H602	79	57H766	89	57H947	89	58G035	23
57H040-10	63	57H252	73	57H420	65	57H606	74	57H767	89	57H948	89	58G036	26
57H042	63	57H253	73	57H424	65	57H610	74	57H768	89	57H950	89	58G040	20
57H042-10	63	57H254	73	57H426	65	57H614	74	57H769	89	57H951	89	58G041	20
57H044	63	57H255	73	57H428	65	57H616	74	57H770	89	57H952	89	58G042	24
57H046	63	57H256	73	57H430	65	57H617	74	57H771	89	57H953	89	58G043	25
57H046-5	63	57H257	73	57H432	65	57H618	74	57H820	87	57H954	89	58G044	26
57H048	63	57H258	73	57H434	65	57H619	74	57H822	87	57H955	92	58G047	46
57H048-5	63	57H259	73	57H438	65	57H620	75	57H824	87	57H956	92	58G067	46
57H050	63	57H260	67	57H440	65	57H621	75	57H826	87	57H957	74	58G077	47
57H050-5	63	57H261	67	57H442	65	57H623	75	57H828	87	57H958	92	58G080	21
57H052	63	57H262	67	57H444	65	57H625	75	57H830	83	57H959	92	58G081	20
57H054	63	57H263	67	57H446	65	57H626	75	57H832	83	57H960	91	58G082	19
57H054-5	63	57H266	70	57H448	65	57H628	75	57H834	83	57H961	91	58G083	26

Ref.	Str.	Ref.	Str.	Ref.	Str.	Ref.	Str.	Ref.	Str.	Ref.	Str.		
58G085	27	59G120	41	60H086.	114	60H629	116	60H951	122	61H704	126	K/50G287-12	107
58G086	27	59G187	40	60H087	114	60H630	116	60H952	122	61H706	126	K/58G030-30	23
58G087	30	59G188	41	60H088	114	60H631	116	60H953	123	61H709	126	K/58G150-14	107
58G088	31	59G207	42	60H089	114	60H632	116	60H954	123	61H730	126	K/59G370-T	44
58G089	20	59G208	42	60H090.	114	60H633	116	60H959	122	61H740	126	K00073	102
58G092	30	59G209	42	60H092	114	60H634	116	60H968	122	62H110	127	K00103	103
58G093	31	59G220	42	60H094.	114	60H635	116	60H971	135	62H111	127	K00104	103
58G094	30	59G243	43	60H096	114	60H636	116	60H972	135	62H112	127	K02026	107
58G096	18	59G244	43	60H097	114	60H637	116	61H105	125	62H121	127	K02027	107
58G097	21	59G261	55	60H172	115	60H638	116	61H106	125	62H130	127	K111767	25
58G098	24	59G261-147	56	60H174	115	60H639	116	61H107	125	62H131	127	K111769	25
58G150	32	59G262	55	60H176	115	60H640	116	61H108	125	62H140	127	K111786	44
58G151	32	59G320	50	60H178	115	60H641	116	61H114	125	62H141	127	K113791	101
58G486	47	59G324	50	60H180	115	60H642	116	61H116	125	62H140	128	K113813	101
58G488	47	59G325	50	60H190	115	60H643	116	61H118	125	62H211	128	K113881	107
58G491	47	59G335	50	60H192	115	60H644	116	61H120	125	62H212	128	K113885	107
58G492	48	59G343	51	60H194	115	60H645	116	61H121	125	62H320	128	K113962	60
58G493	48	59G347	51	60H196	115	60H647	116	61H122	125	62H321	128	K114501	60
58G495	48	59G370	44	60H210	117	60H649	116	61H123	125	62H330	128	K114587	60
58G495-144	49	59G371	44	60H212	117	60H650	116	61H124	125	62H331	128	K114677	60
58G495-731	48	59G383	45	60H214	117	60H651	116	61H125	125	62H341	128	K114805	25
58G495-732	48	59G392	51	60H222	117	60H652	116	61H126	125	62H613	128	K114807	25
58G495-733	49	59G394	51	60H224	117	60H653	116	61H128	125	62H614	128	K28819	107
58G505	35	59G395	52	60H226	117	60H654	116	61H130	125	62H700	129	K28820	107
58G527	35	59G401	45	60H228	117	60H655	116	61H132	125	62H708	128	K28823	107
58G528	36	59G401-30	45	60H230	117	60H656	116	61H134	125	62H710	128	K28824	107
58G529	35	59G402	45	60H232	117	60H657	116	61H136	125	62H712	128	K28838	107
58G605	38	59G402-30	45	60H234	117	60H658	116	61H138	125	62H714	128	K74834	101
58G712	35	59G446	58	60H236	117	60H659	116	61H140	125	62H720	128	K74845	107
58G722	34	59G449	58	60H240	117	60H660	116	61H142	125	63H104	127	K74846	107
58G725	33	59G522	53	60H245	131	60H661	116	61H144	125	63H106	127	K74847	107
58G726	33	59G524	53	60H265	116	60H664	116	61H146	125	63H108	127	K78972	107
58G727	34	59G606-145	57	60H280	116	60H665	116	61H148	125	63H110	127	K78975	107
58G728	34	59G606-146	57	60H300	115	60H666	116	61H150	125	63H112	127	K84925	102
58G735	33	59G606-147	56	60H302	115	60H667	116	61H190	125	63H204	127	K85002	102
58G736	33	59G607	56	60H508	135	60H668	116	61H194	125	63H206	127	K85081	102
58G738	34	59G607-145	57	60H512	135	60H669	116	61H2P1	124	63H208	127	K90234	107
58G782-96	39	59G607-146	57	60H516	116	60H685	116	61H2P5	124	63H210	127		
58G783	38	59G607-147	56	60H518	116	60H705	134	61H2P8	124	63H212	127		
58G784-96	39	59G607-147A	56	60H520	116	60H713	134	61H2P9	124	64H105	129		
58G784-97	39	59G607-148	56	60H522	116	60H718	134	61H2S1	124	64H110	129		
58G785	38	59G607-149	56	60H524	116	60H719	134	61H2S5	124	64H120	129		
58G787	38	59G607-149A	56	60H526	116	60H725	134	61H2S9	124	64H130	129		
58G788-96	39	59G607-149B	56	60H528	116	60H739	115	61H2T1	124	64H131	129		
58G788-97	39	59G607-149C	56	60H532	116	60H802	117	61H2T5	124	64H205	129		
58G789	39	59G607-150	56	60H534	116	60H804	117	61H2T9	124	64H210	129		
58G791	32	59G608	56	60H536	116	60H805	134	61H315	135	65H105	130		
58G792	32	59G608-145	57	60H540	116	60H808	134	61H325	135	65H106	130		
58G858	36	59G678	52	60H542	116	60H810	114	61H335	135	65H110	131		
58G862	36	59G678-30	52	60H544	116	60H812	114	61H345	135	65H115	130		
58G867	37	59G679-30	52	60H546	116	60H814	114	61H355	135	66H108	131		
58G874	36	59G680	52	60H548	116	60H820	115	61H3S1	124	66H112	131		
58G875	37	59G680-30	52	60H550	116	60H825	121	61H3S5	124	66H208	131		
58G876	37	59G717	53	60H554	116	60H832	121	61H3S8	124	66H212	131		
58G878	37	59G800	54	60H556	116	60H835	121	61H3S9	124	66H310	131		
58G941-71	58	59G801	54	60H558	116	60H860	134	61H3T1	124	66H313	131		
58G941-73	58	59G806	54	60H562	116	60H896	121	61H3T5	124	66H320	131		
58G943	57	59G812	54	60H566	116	60H897	121	61H3T8	124	66H600	119		
58G943-71	58	59G873	55	60H570	116	60H900	122	61H3T9	124	66H602	119		
58G943-73	58	59G887	55	60H572	116	60H902	121	61H401	123	66H604	119		
58G947-71	58	60H000	115	60H576	116	60H904	121	61H402	123	66H606	119		
58G950	57	60H005	135	60H578	116	60H906	121	61H404	123	66H615	119		
58G950-71	58	60H006	135	60H582	116	60H908	121	61H405	123	66H617	119		
58G950-73	58	60H007	135	60H588	116	60H910	121	61H434	125	66H619	119		
58G952	58	60H008	121	60H590	116	60H914	121	61H436	125	66H620	120		
58G952-71	58	60H010	121	60H592	116	60H916	121	61H437	125	66H620-6	120		
58G952-73	58	60H070	114	60H594	116	60H921	122	61H438	125	66H622	120		
58G960	46	60H071	114	60H602	116	60H924	122	61H440	125	66H622-6	120		
58G971	46	60H072	114	60H604	116	60H925	122	61H455	124	66H624	120		
58GE100	22	60H073	114	60H606	116	60H928	122	61H465	124	66H624-6	120		
58GE101	22	60H074	114	60H608	116	60H929	122	61H515	123	66H646	118		
58GE102	30	60H075	114	60H610	116	60H930	122	61H523	123	66H648	118		
59G019	53	60H076	114	60H619	116	60H931	122	61H525	123	66H650	118		
59G020	49	60H077.	114	60H620	116	60H934	122	61H530	123	73K002	114		
59G021	49	60H078.	114	60H621	116	60H937	122	61H532	123	73K004	114		
59G022	49	60H079	114	60H622	116	60H938	122	61H534	123	89G940-71	58		
59G063	40	60H080.	114	60H623	116	60H939	122	61H536	123	89G940-73	58		
59G071	43	60H081	114	60H624	116	60H940	122	61H603	126	79G100	97		
59G072	40	60H082.	114	60H625	116	60H941	122	61H605	126	GD04	60		
59G087	40	60H083	114	60H626	116	60H942	122	61H607	126	GD05	60		
59G088	41	60H084	114	60H627	116	60H946	122	61H700	127	K/50G271-14	107		
59G110	41	60H085	114	60H628	116	60H950	122	61H702	126	K/50G284-12	107		



Grupa Topex Sp. z o.o. Sp.k.
ul. Pograniczna 2/4,
02-285 Warszawa
tel. +48 22 573 03 00
fax +48 22 573 04 00
office@grupatopex.com



Россия

ООО «ТОПЕКС РУС»
108811 Россия, г. Москва,
г. Московский;
1 микрорайон; дом 23 «Д»;
3 этаж; офис 2,3
Тел. +7 499 346 37 27
office@topex.net.ru



Україна

ТОВ «Топекс Україна»
07400, м. Бровари,
вул. О.Онiкiєнка, буд. 134,
тел +38044-495-45-04
office@topex.ua



Romania

Topex Tools Romania SRL
tel: 0040 37 2740 619
fax: 0040 37 2870 177
romania@grupatopex.com

Grupa Topex nie ponosi żadnej odpowiedzialności za możliwe błędy w katalogach, broszurach i innych materiałach drukowanych. Grupa Topex zastrzega sobie prawo do dokonywania zmian w produktach bez uprzedzenia. Dotyczy to również produktów już zamówionych. Zamienniki mogą być dostarczone bez dokonywania jakichkolwiek zmian w specyfikacjach już uzgodnionych. Wszystkie znaki towarowe w tym materiale są własnością odpowiednich firm. Znaki towarowe GRAPHITE, VERTO, NEO, Top Tools są własnością "Grupa Topex Sp. z o.o." Sp.k. Niniejszy katalog ma jedynie charakter informacyjny i nie stanowi oferty zawarcia umowy. Zdjęcia umieszczone w katalogu są zdjęciami poglądowymi i produkty w rzeczywistości mogą się nieznacznie różnić od zamieszczonych ilustracji. Publikacja chroniona prawem autorskim. Kopiowanie, przedrukowywanie i rozpowszechnianie całości lub fragmentów, również na nośnikach magnetycznych lub elektronicznych bez zgody firmy Grupa Topex jest zabronione.

Grupa Topex shall not be held liable for any errors in catalogues, brochures and other printed materials. Grupa Topex stipulates the right to modify the products without prior notice. This shall also apply to products already ordered. Replacements may be delivered without any modifications of specifications already agreed upon. All trademarks, inclusive of those contained in this material, are the property of relevant companies. GRAPHITE, VERTO, NEO, Top Tools trademarks are the property of "Grupa Topex Sp. z o.o." Sp.k. Limited Partnership. This catalogue is intended for informational purposes only and is not a binding offer for agreement. Pictures in the catalogue are for illustration purposes, real products may slightly vary from provided illustrations.

Publication protected under copyright law. Copying, reprinting and distribution of the entirety or parts thereof, inclusive of on magnetic and electronic media, without the consent of Grupa Topex shall be prohibited.

Grupa Topex не несет никакой ответственности за возможные ошибки в каталогах, брошюрах и других печатных материалах. Grupa Topex оставляет за собой право без предупреждения вносить изменения в продукты. Это касается также уже заказанных продуктов. Измененные продукты могут поставляться без внесения каких-либо изменений в уже согласованные спецификации. Все товарные знаки в данном материале являются собственностью соответствующих компаний. Товарные знаки GRAPHITE, VERTO, NEO, Top Tools являются собственностью компании «Grupa Topex Общество с ограниченной ответственностью» Коммандитное товарищество. Данный каталог носит информационный характер, не является офертой и не несет никаких обязательств по заключению договора. Представленные в каталоге фотографии являются наглядными примерами товаров, фактический внешний вид товара может незначительно отличаться от изображенного на фотографии.

Публикация защищена законом об авторских правах. Копирование, перепечатка и распространение всего текста полностью или его фрагментов, в том числе на магнитных и электронных носителях, без согласия компании Grupa Topex запрещены.

