







SYMMONS® Duro®

Location:

SLW3612PP

Two Handle Widespread Lavatory Faucet
Specification Submittal



<p>Model Numbers</p>	<p>Feature Highlights</p>
<p><input type="checkbox"/> SLW3612PP Two Handle Widespread Lavatory Faucet with Push Pop Drain Assembly</p>	<ul style="list-style-type: none"> • 8" to 16" mount configuration • Quarter turn ceramic cartridges • 6-5/8" height • Standard 1.0 gpm (3.8 L/min) flow rate • Faucet shall be metal construction, plated in standard polished chrome finish
<p>Finish Options/Modifications</p>	<p>Compliance</p>
<p><input type="checkbox"/> 05  0.5 gpm (1.9 L/min) flow restrictor</p> <p><input type="checkbox"/> H2  Alternative lever handle (Chrome and Satin Nickel only)</p> <p><input type="checkbox"/> BBZ Brushed Bronze finish</p> <p><input type="checkbox"/> MB Matte Black finish</p> <p><input type="checkbox"/> STN Satin Nickel finish</p> <p>Note: Append appropriate suffix to model number.</p>	<p>ASME A112.18.1/CSA B125.1 NSF/ANSI/CAN 61: Q<1, NSF/ANSI 372 WaterSense 1.0 gpm (3.8 L/min)</p>   <p>Warranty</p> <p>Limited Lifetime - to the original end purchaser in consumer/residential installations.</p> <p>10 Years - for commercial/industrial installations. Refer to www.symmons.com/warranty for complete warranty information.</p> 

Architectural/ Engineering Specification

Symmons Duro Two Handle Widespread Lavatory Faucet _____ With 8" to 16" mount configuration, quarter turn ceramic cartridges, 6-5/8" height, Standard 1.0 gpm (3.8 L/min) flow rate, Faucet shall be metal construction, plated in standard polished chrome finish, 10 Year commercial Warranty. ASME A112.18.1/CSA B125.1, NSF/ANSI/CAN 61: Q<1, NSF/ANSI 372 , WaterSense 1.0 gpm (3.8 L/min), complaint. Available options include: "05 - 0.5 gpm (1.9 L/min) flow restrictor", "H2 - Alternative lever handle (Chrome and Satin Nickel only)", "BBZ - Brushed Bronze finish", "MB - Matte Black finish", "STN - Satin Nickel finish".

Dimensions

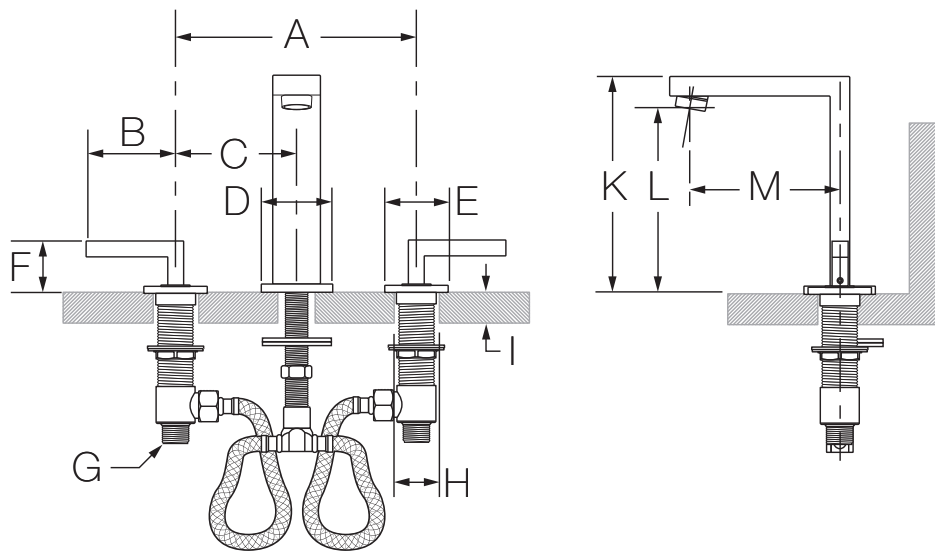

Measurements	
A	Min. 8", 203 mm Max. 16", 406 mm
B	2-3/4", 70 mm
C	4", 102 mm
D	2-1/8", 54 mm
E	2", 51 mm
F	1-5/8", 40 mm
G	1/2-14 NPSM
H	(3x) Hole size Min. Ø 1-1/4", 32 mm Max. Ø 1-3/8", 35 mm
I	Deck Thickness Ref. Min. 7/8", 22 mm Max. 2-3/8", 60 mm
K	6-5/8", 170 mm
L	5-5/8", 143 mm
M	4-5/8", 116 mm
O	1-5/8", 41 mm
P	2-3/4", 70 mm
Q	1-3/4", 44 mm
R	2-5/8", 67 mm

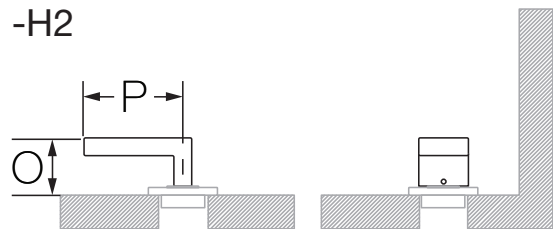
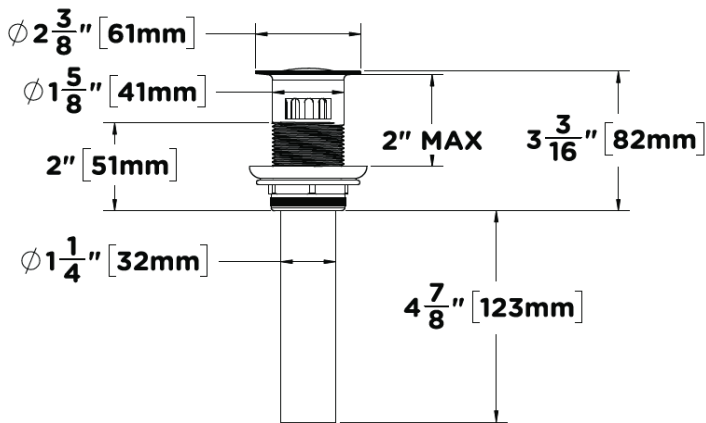

Note: Dimensions subject to change without notice.