

nzwardrobes

GENERIC SHELVING INSTALLATION GUIDE

For nzwardrobes.co.nz ventilated shelving systems.

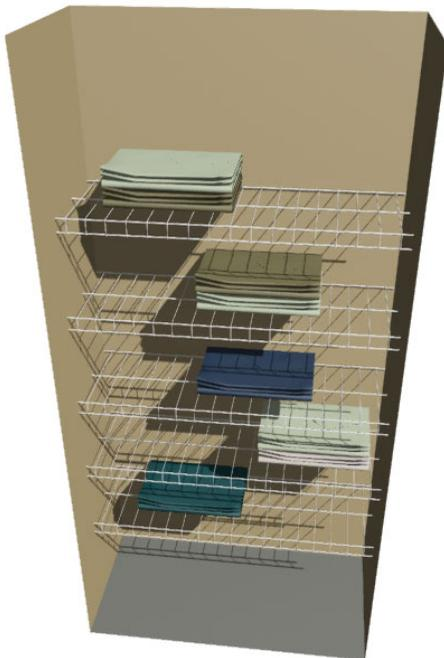
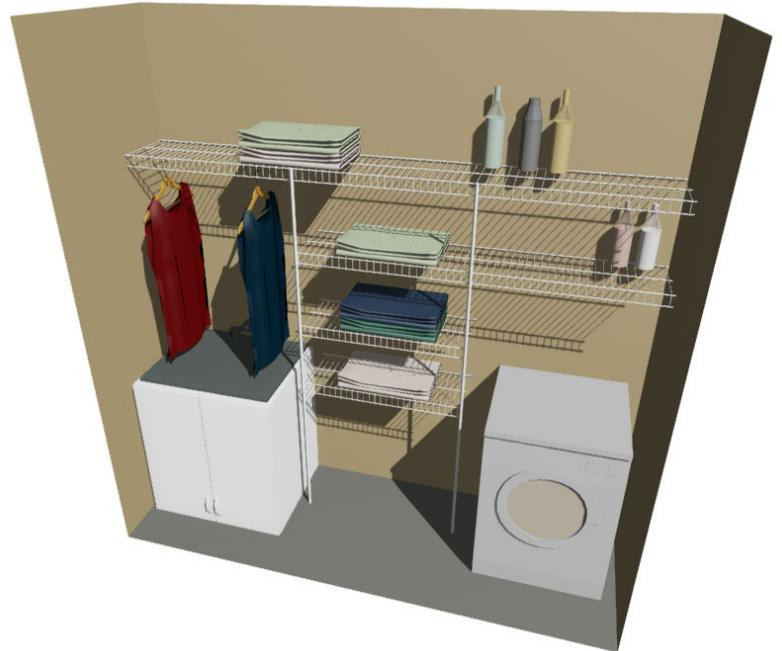
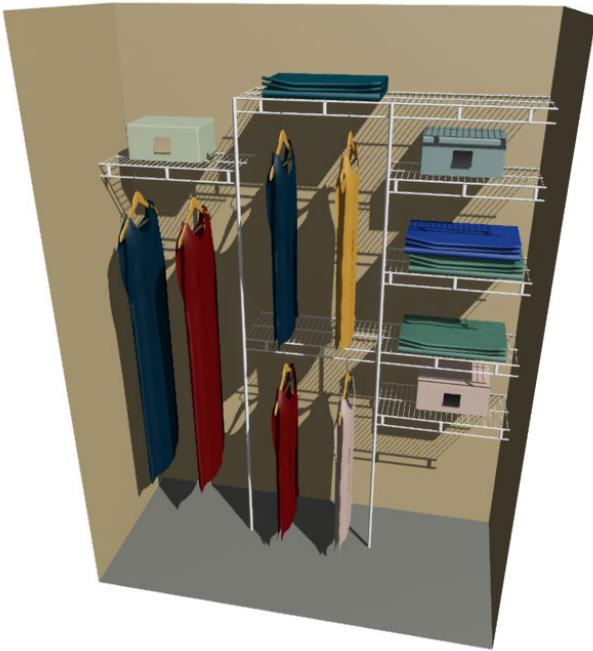

For an online installation guide go to: nzwardrobes.co.nz/installation

Or to speak to one of our friendly staff.

Phone 0800 (nzwardrobes) 0800 699 273

IMPORTANT TIPS

1. If you have purchased more than one wardrobe organiser, do the smallest or easiest one first! Once you have done one, the rest will be easy. Linen or H.W.C are normally the easiest.

2. This is a generic installation guide eg. no matter what your shelving layout is, follow these steps for installation.

3. Go to nzwardrobes.co.nz/installation for online installation videos (recommended).

TOOLS REQUIRED

- Tape Measure
- Cordless Drill
- Level
- Pencil
- 5.5mm Drill Bit
- No. 2 Square Head Screw Bit



PARTS INDEX

PLEASE NOTE:

Some parts may not be required in your kitset.

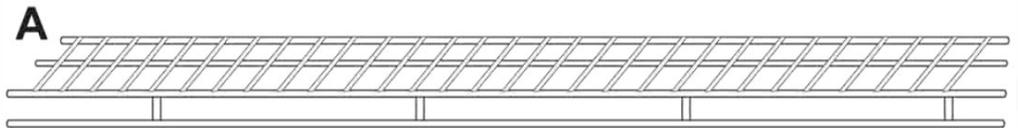

A Shelving

B Pole

- with Clips, Joiner and End Caps supplied

C Wall Anchor

D End Wall Bracket

F Back Wall Clip

G Screw



C



D



F



G

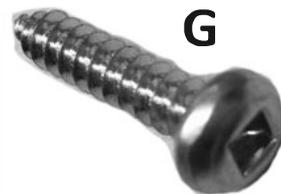

SEE PAGE 10 FOR INSTRUCTIONS IF REQUIRED

H Support Bracket

I Saddle Clip

H



I



EXAMPLE OF INSTALLED WARDROBE ORGANISER

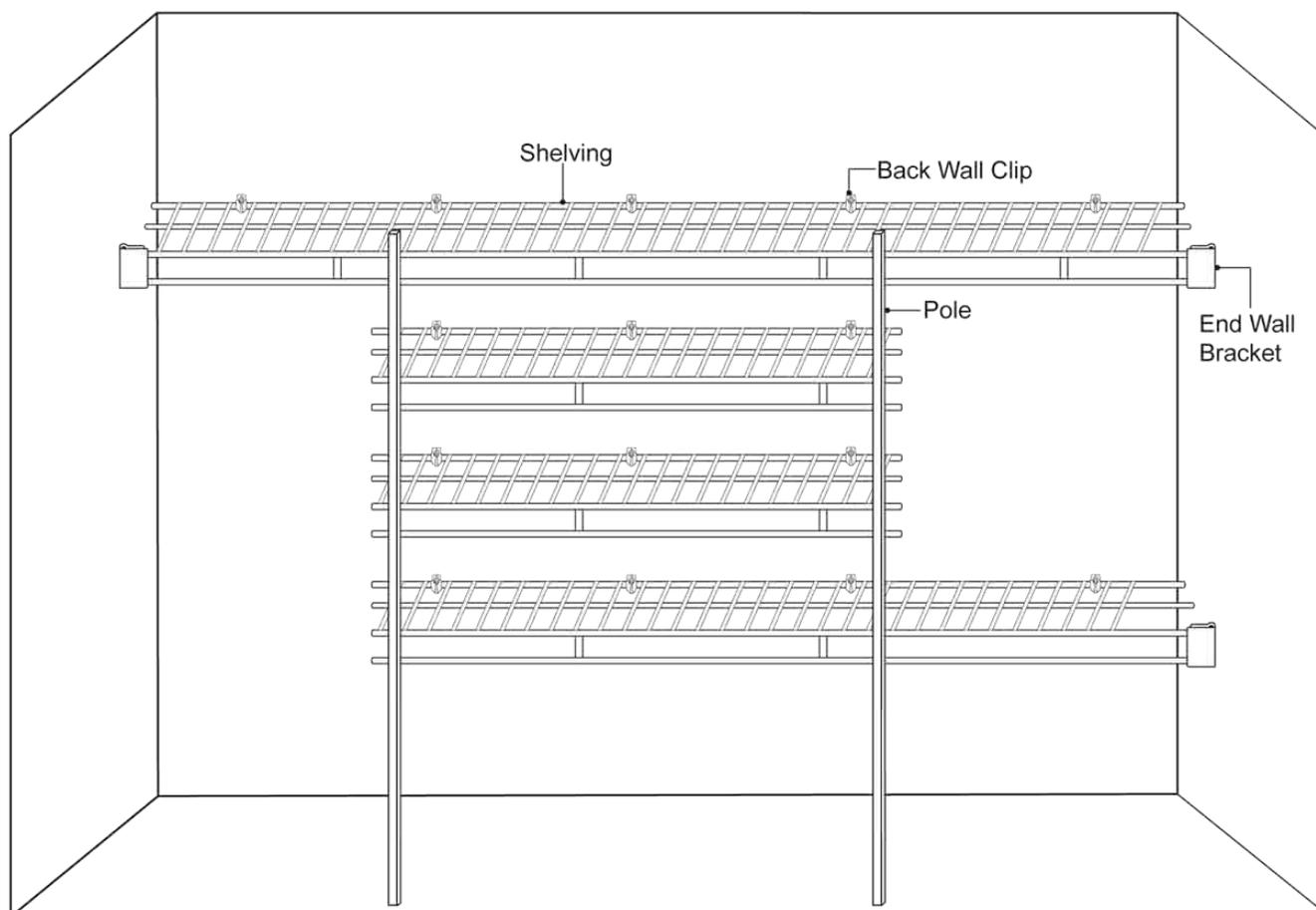

STEP 1 - SHELVING STARTING POSITION

Lay shelving on the floor starting with the bottom shelf in order from top to bottom. Each shelf needs to be directly below where they will be installed on the wall above.

See example below.

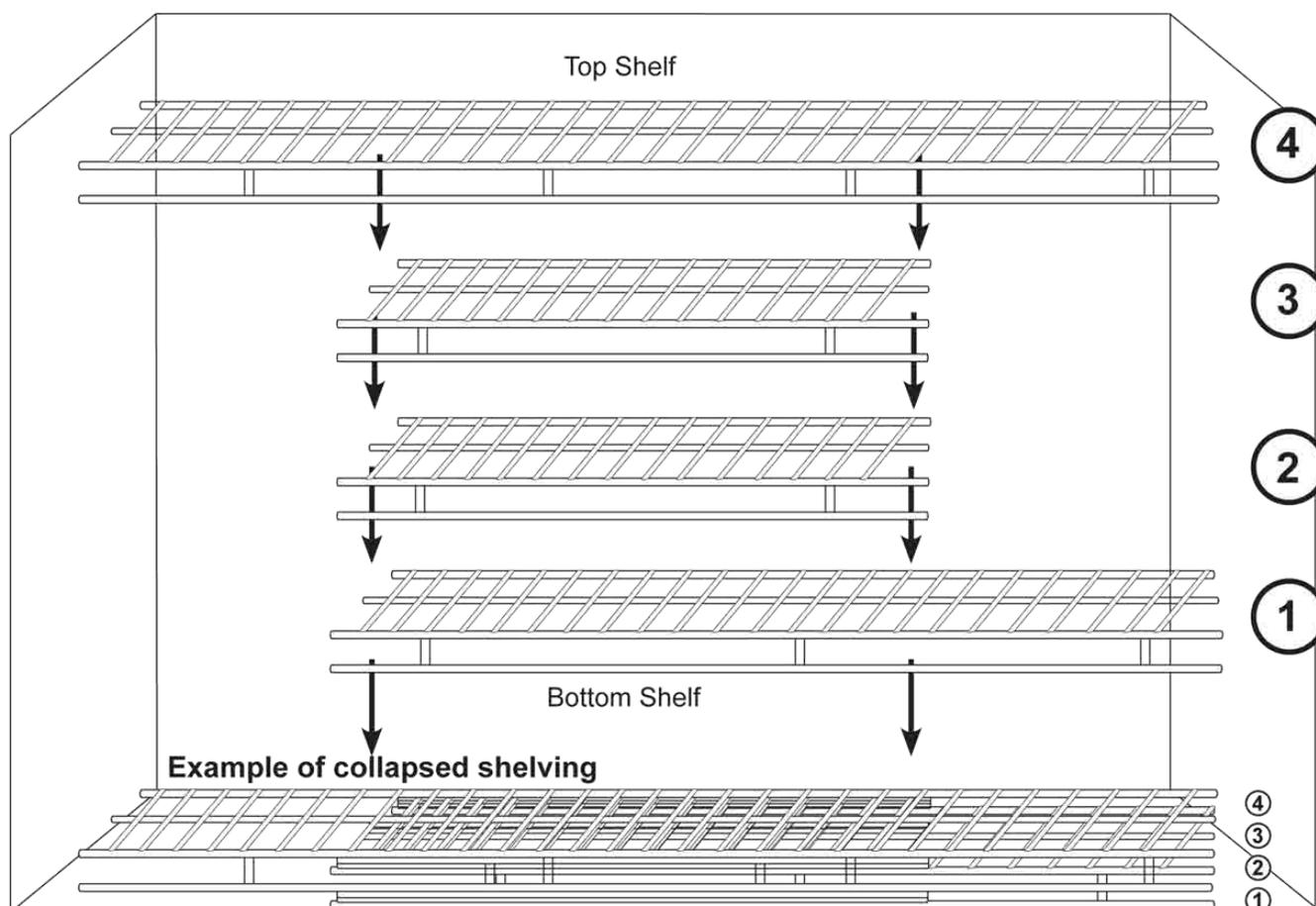

STEP 2 - MARKING AND DRILLING

Using the **Pole** with **Pole Clips** already attached, place the **Pole**, one at a time, 50mm away from the side of the wall (*see pole A and D*), ensuring the **Pole** is level.

Mark the wall directly beside the **Screws** on the **Pole**. Marks are only required where **Shelves** are to be installed. *See example below.*

Move the **Pole** along to where the shelving overlaps (*see pole B and Fig 1.*), mark again beside the screws where the shelves will sit on the wall. Continue along to where the shelves next overlap (*see pole C*) and again mark the wall.

Ensure the pole is level at each step!

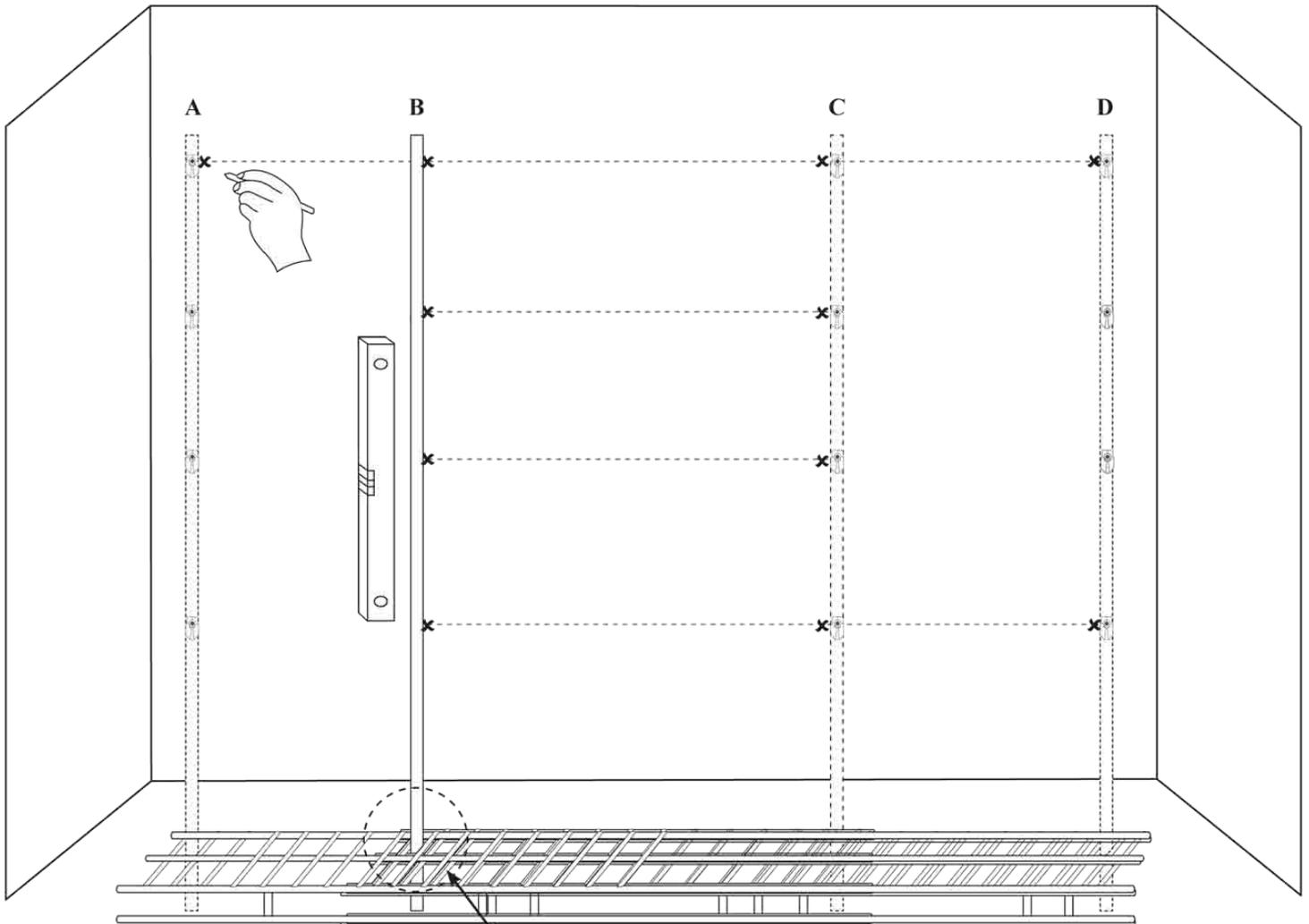
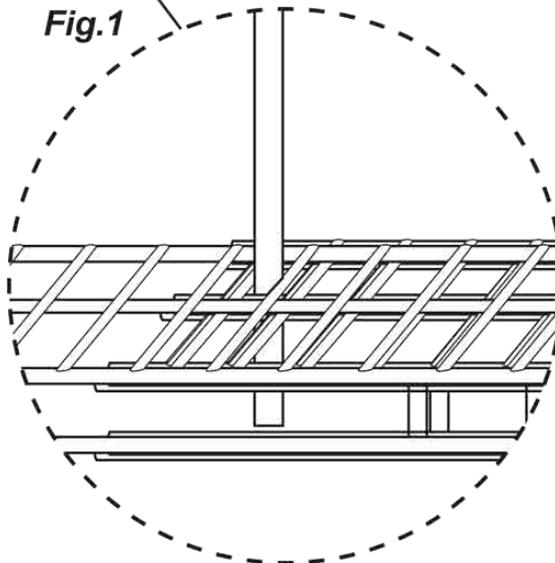
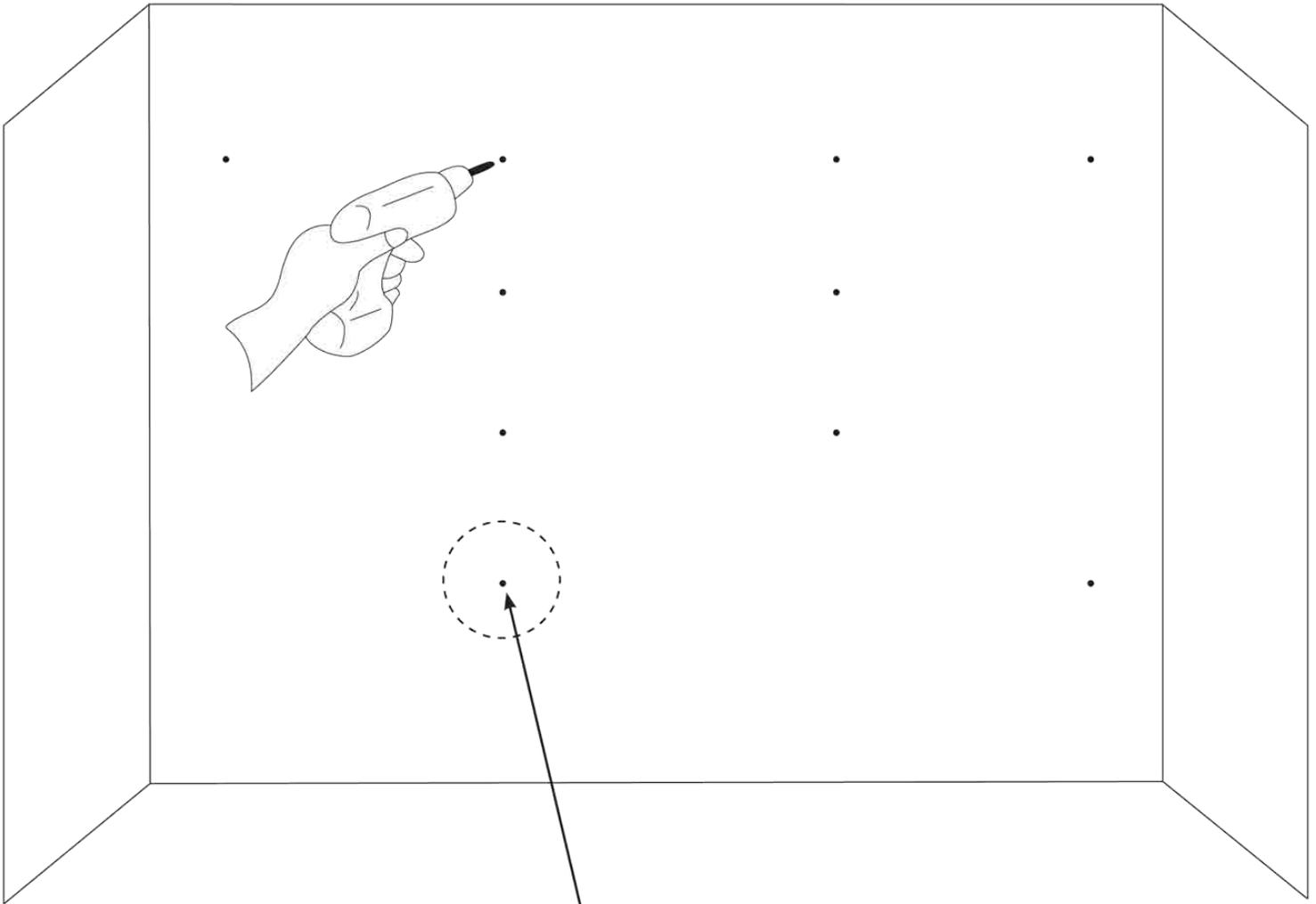

Fig.1



STEP 3

Drill holes where you have marked the wall.



STEP 4

Push the **Back Wall Clips** half way into the holes as in **Fig 2**.

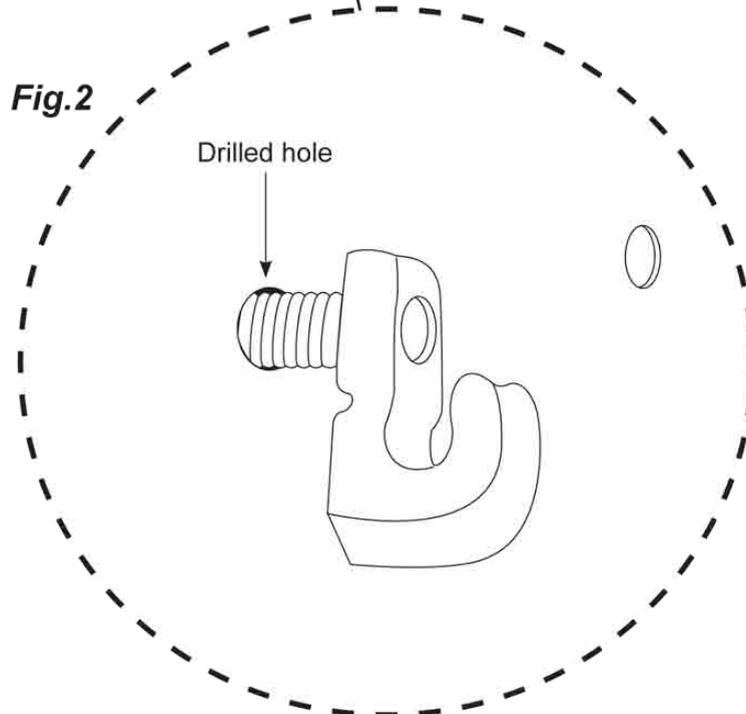

STEP 5

Hang the shelves flat against the wall over the **Back Wall Clips** in the correct position, as shown in Fig 3.

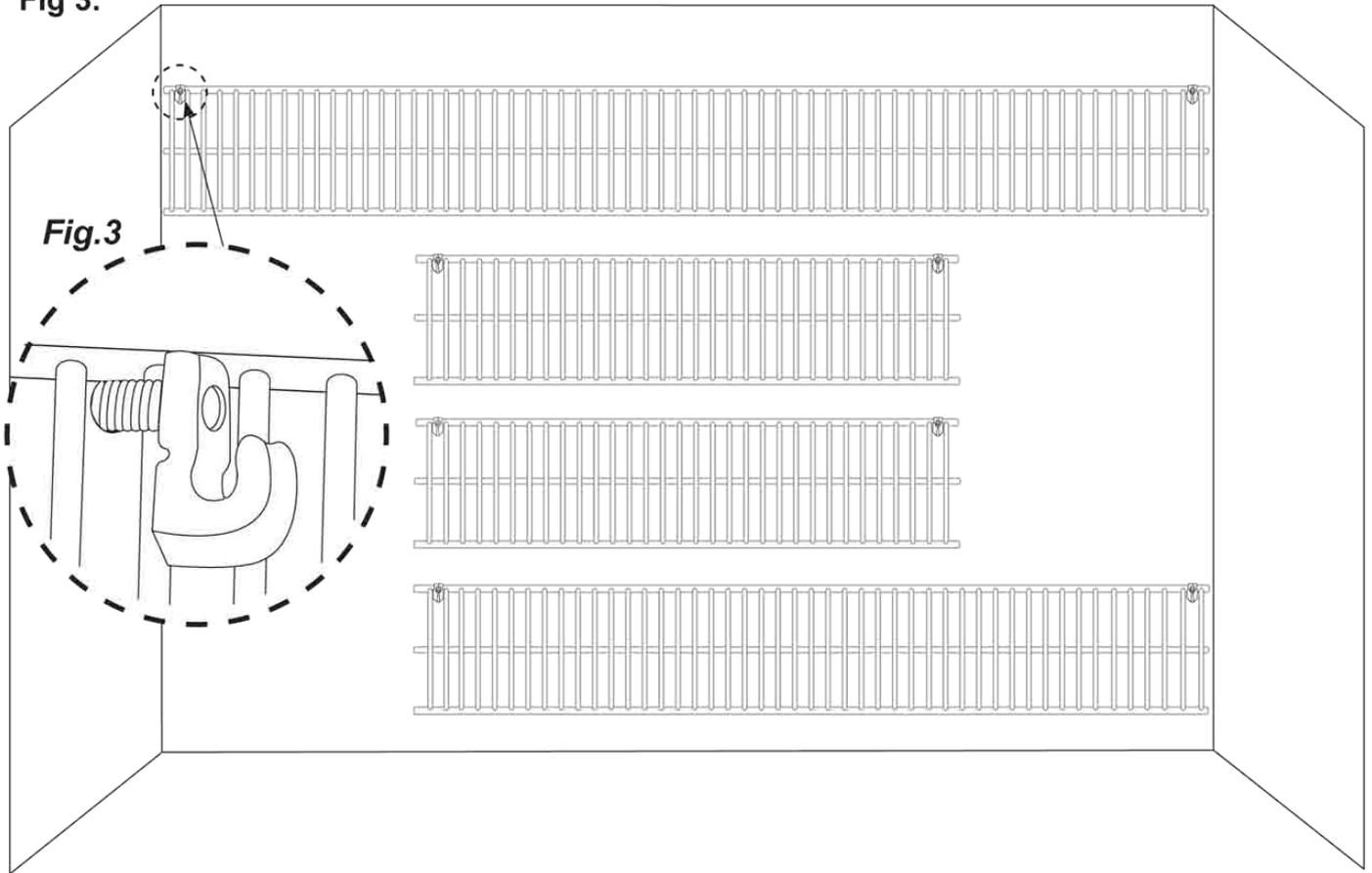

STEP 6 - DRILLING THE REMAINING HOLES.

Drill holes between the wire, 400mm apart. Remove the shelving.

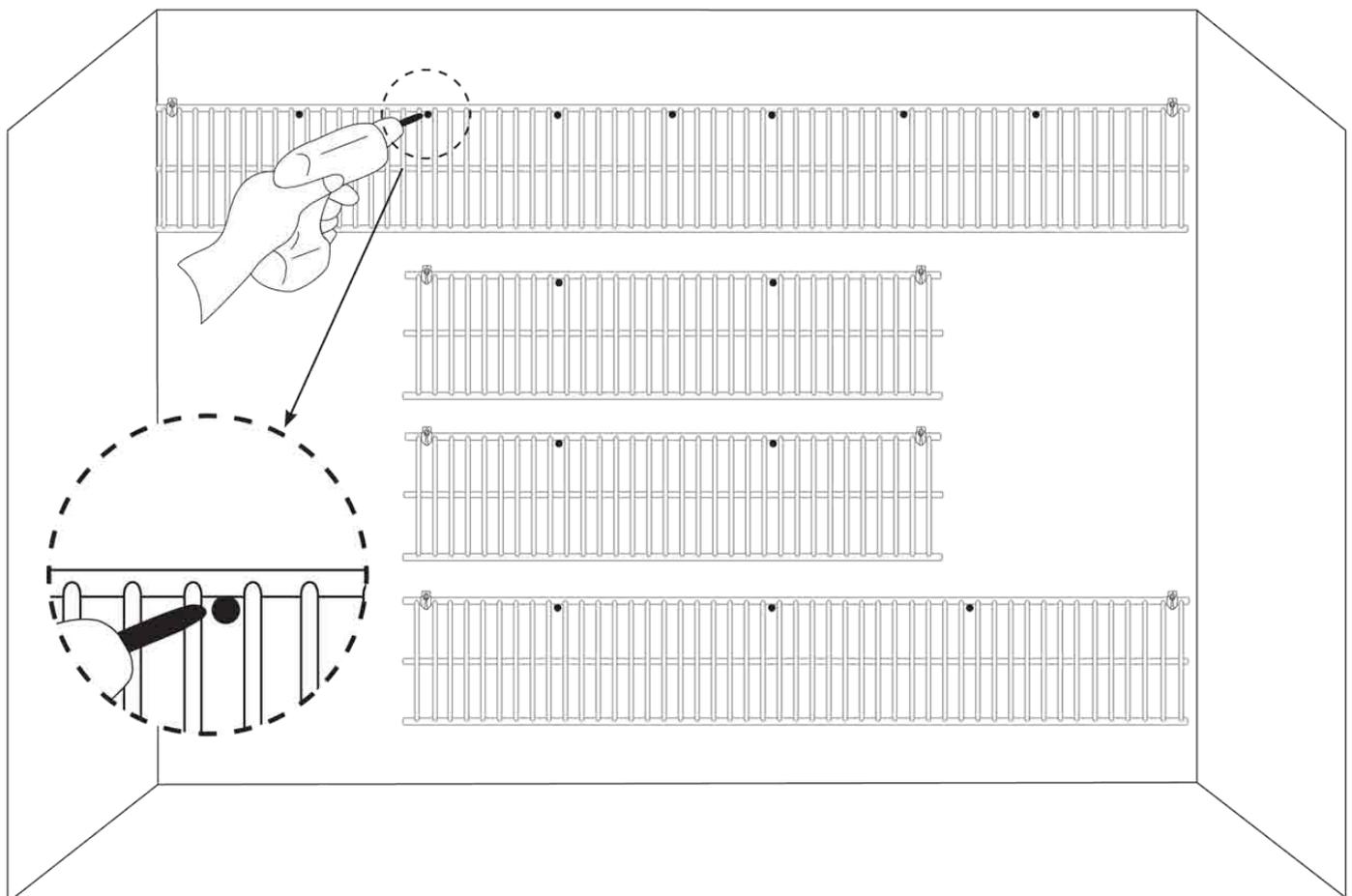

STEP 7 - FIXING THE BACK WALL CLIPS

Push the **Back Wall Clips** all the way into the holes and using a Drill, drill the screws in to tighten.

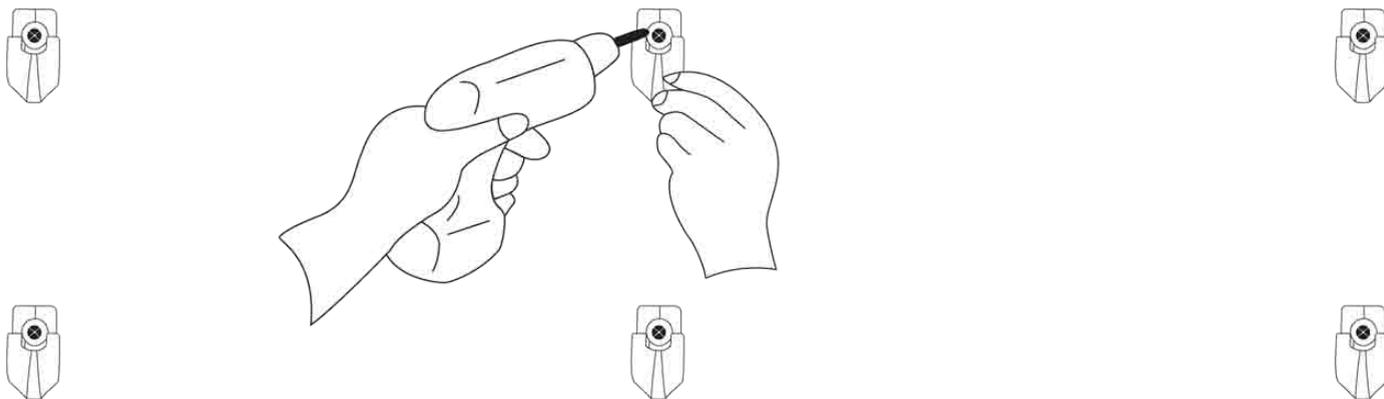

STEP 8 - CLIPPING THE SHELVES IN

Starting with the bottom shelf, fit the shelves into the **Back Wall Clips**. Then clip the poles onto the front of the shelves.

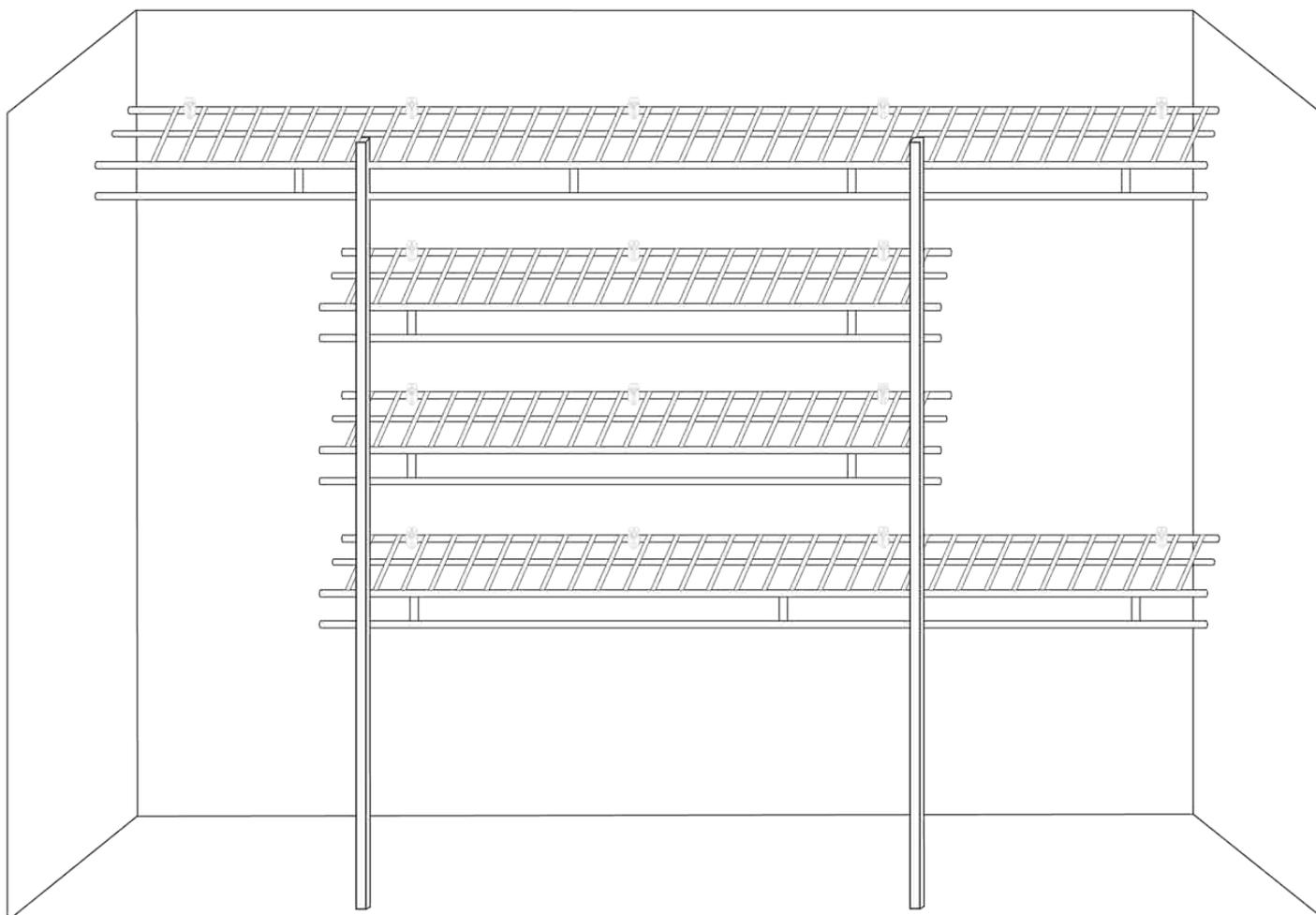

STEP 9 - MARKING THE HOLES FOR THE END WALL BRACKET

Where the end of a shelf meets a wall, slide an **End Wall Bracket** into position and level the shelf.
Mark the wall through the holes of the **End Wall Brackets**.

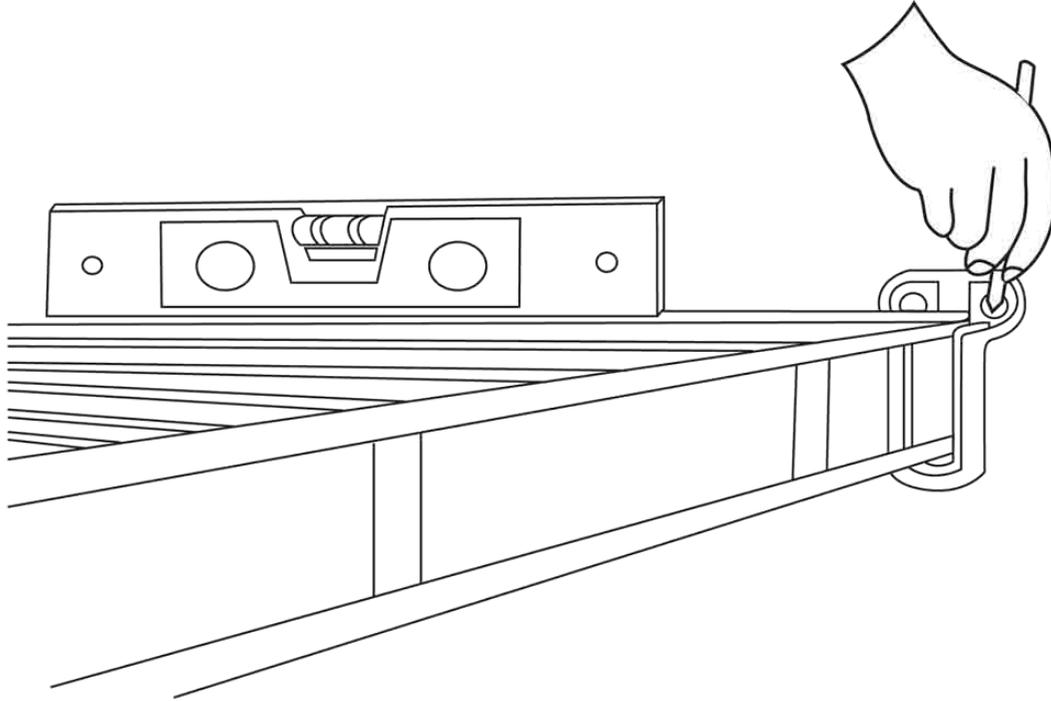

STEP 10 - DRILLING THE HOLES AND INSERTING THE WALL ANCHORS

Remove the **End Wall Bracket** and drill the holes over the marks.

Push the **Wall Anchors** into the holes as in **Fig. 4**.

Position the **End Wall Bracket** into place and drill into the wall anchors as in **Fig. 5**.

Fig.4

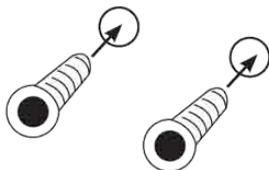
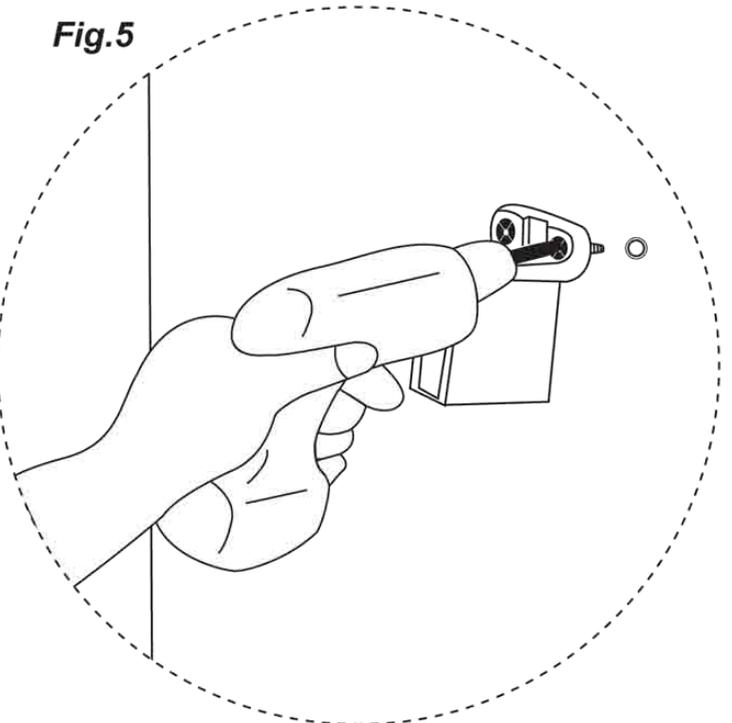
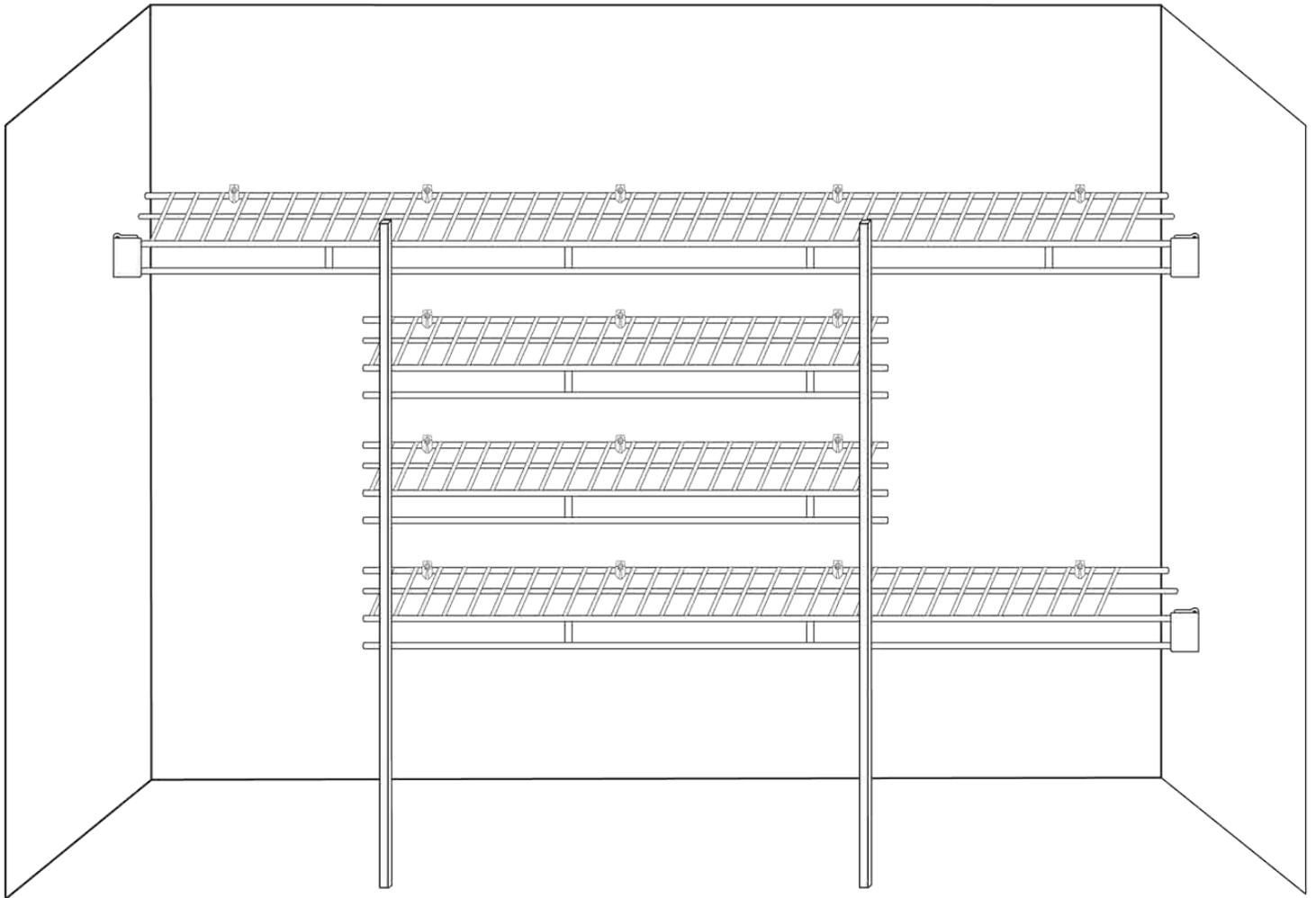

Fig.5



STEP 11

Check shelving and poles are fixed securely.



Please Note: If required, see overleaf for the Support Bracket Installation

SUPPORT BRACKET AND SADDLE CLIP INSTALLATION

Required in situations where shelf spans over 1200mm (1.2 m) long.

Support Bracket (Fig.1)

- Clip the **Support Bracket** to the front of the shelf. Ensure the shelf is level.
- Drill through the hole in the bottom of the bracket into the wall. Push a **Wall Anchor** into the hole.
- Fix the **Support Bracket** to the wall with a screw through both the Support Bracket and **Wall Anchor**.

Saddle Clip (Fig.2)

- We recommend finding a wall stud for extra strength
- Position the **Saddle Clip** over the shelf behind the **Support Bracket**.
 - Mark the holes where the **Saddle Clip** will be screwed to the wall, then drill holes.
 - Push the **Back Wall Anchors** into the holes.
 - Fix the **Saddle Clip** to the wall with screws through the **Saddle Clip** and **Wall Anchors**.

