

nzwardrobes

SINGLE SHELF INSTALLATION GUIDE

For nzwardrobes ventilated shelving systems.



For an online installation guide go to: nzwardrobes.co.nz/installation

Or to speak to one of our friendly staff.

Phone 0800 (nzwardrobes) 0800 699 273

IMPORTANT TIPS

1. If you have purchased more than one wardrobe organiser, do the smallest or easiest one first!
3. You do not need to find a stud/nog when marking holes as our fittings are designed to fit straight into the Gib board.

2. This is a generic installation guide eg. no matter what your shelving layout is, follow these steps for installation.
4. Go to nzwardrobes.co.nz/installation for online installation videos (recommended).
5. The shelves can be cut down using bolt cutters or an angle grinder if required.

TOOLS REQUIRED

- Tape Measure
- Cordless Drill
- Level
- Pencil
- 5.5mm Drill Bit
- No. 2 Square Head Screw Bit



PARTS INDEX

PLEASE NOTE:

Some parts may not be required in your kitset.

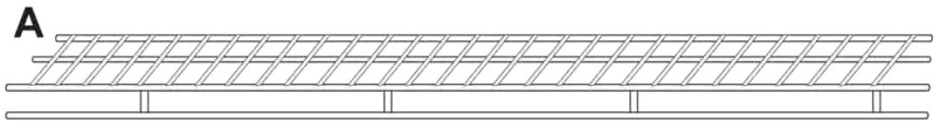

- A Shelving
- B Wall Anchor
- C End Wall Bracket
- D Back Wall Clip
- E Screw



SEE PAGE 10 FOR INSTRUCTIONS IF REQUIRED

- F Support Bracket
*Support Bracket only supplied with shelves that span over 1200mm wide
- G Saddle Clip
- 3 x Wall Anchors (B)
- 3 x Screws (E)



EXAMPLE OF INSTALLED WARDROBE SHELF

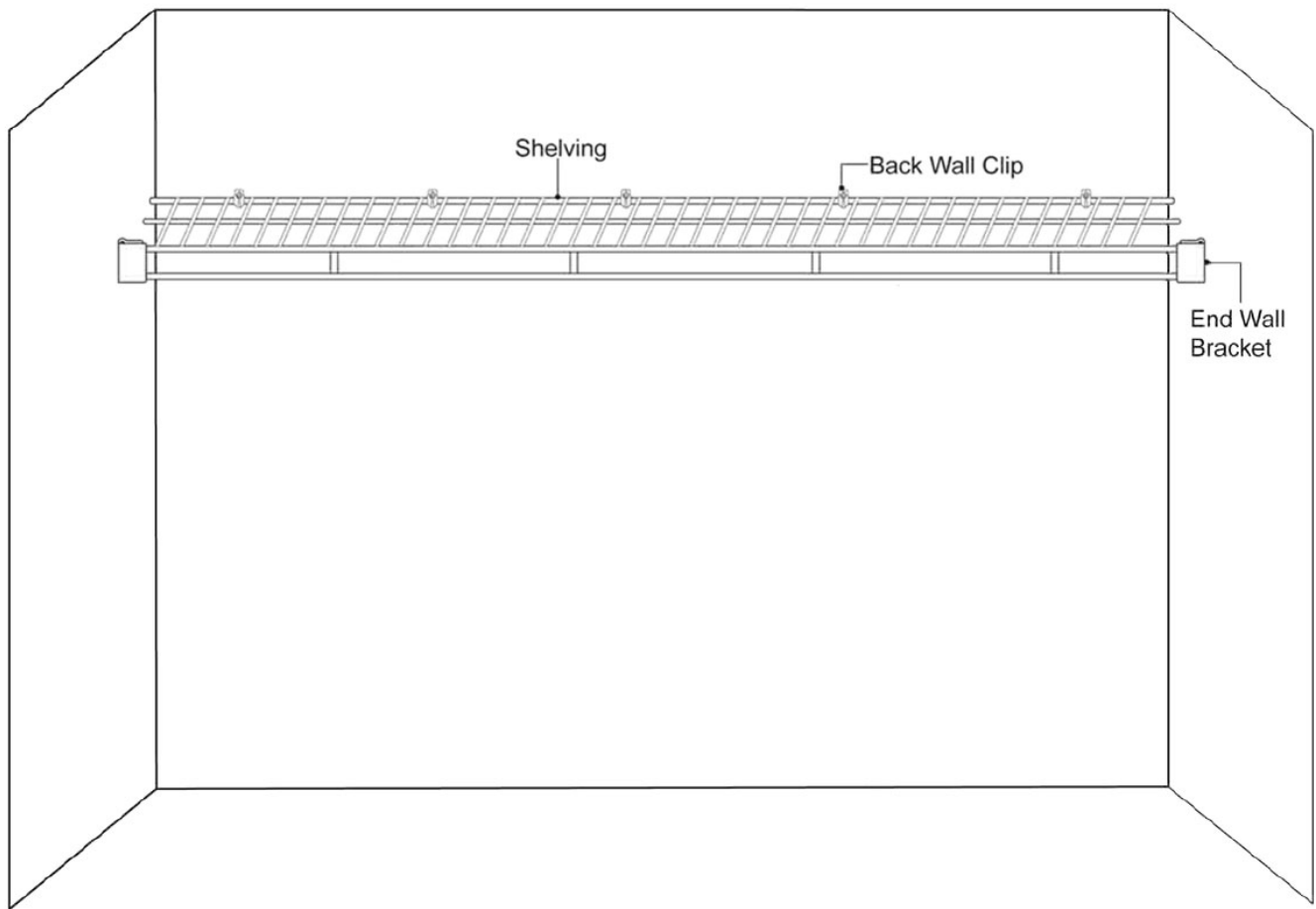

STEP 1 - MARKING THE WALL

Measure 1785mm from the floor on the left hand side then measure 60mm in from side wall. Make a mark on the wall. Do the same on the right hand side.

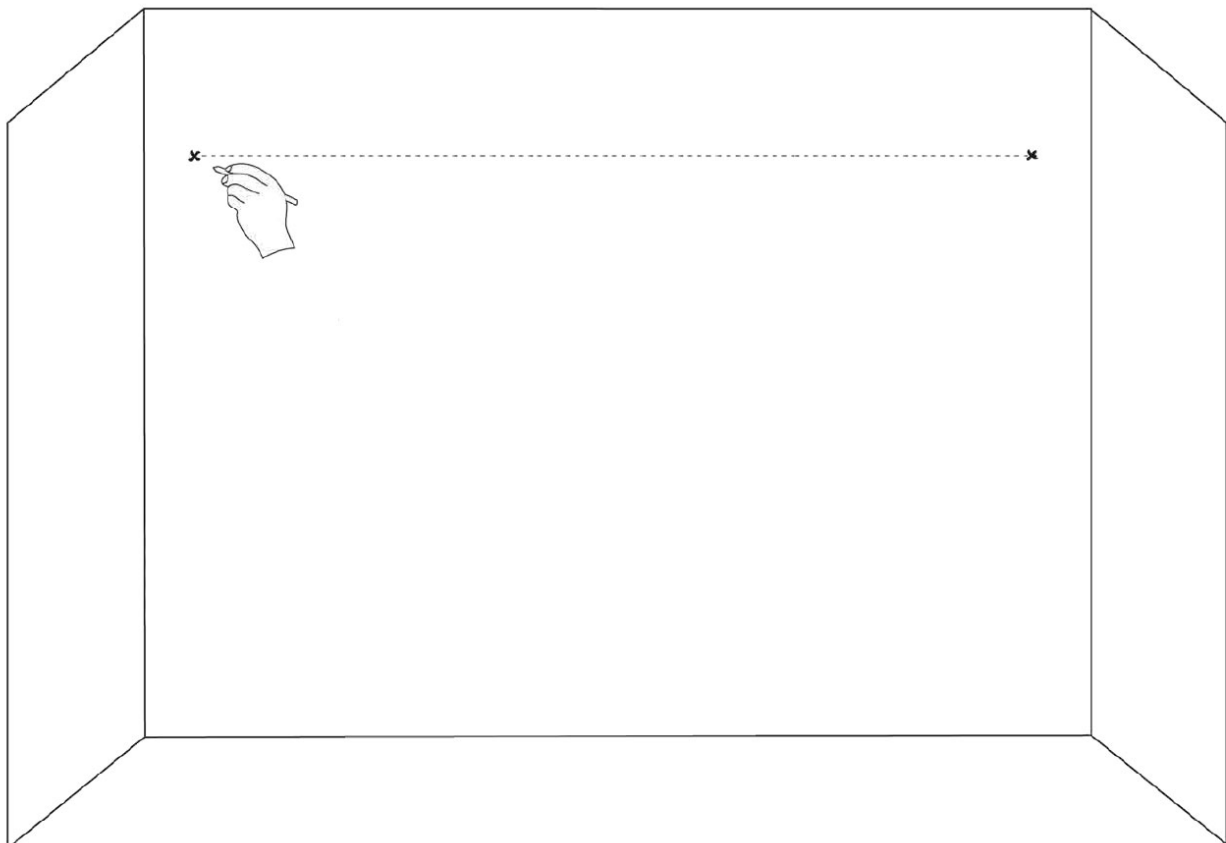

STEP 2 - DRILLING

Drill holes where you have marked the wall.

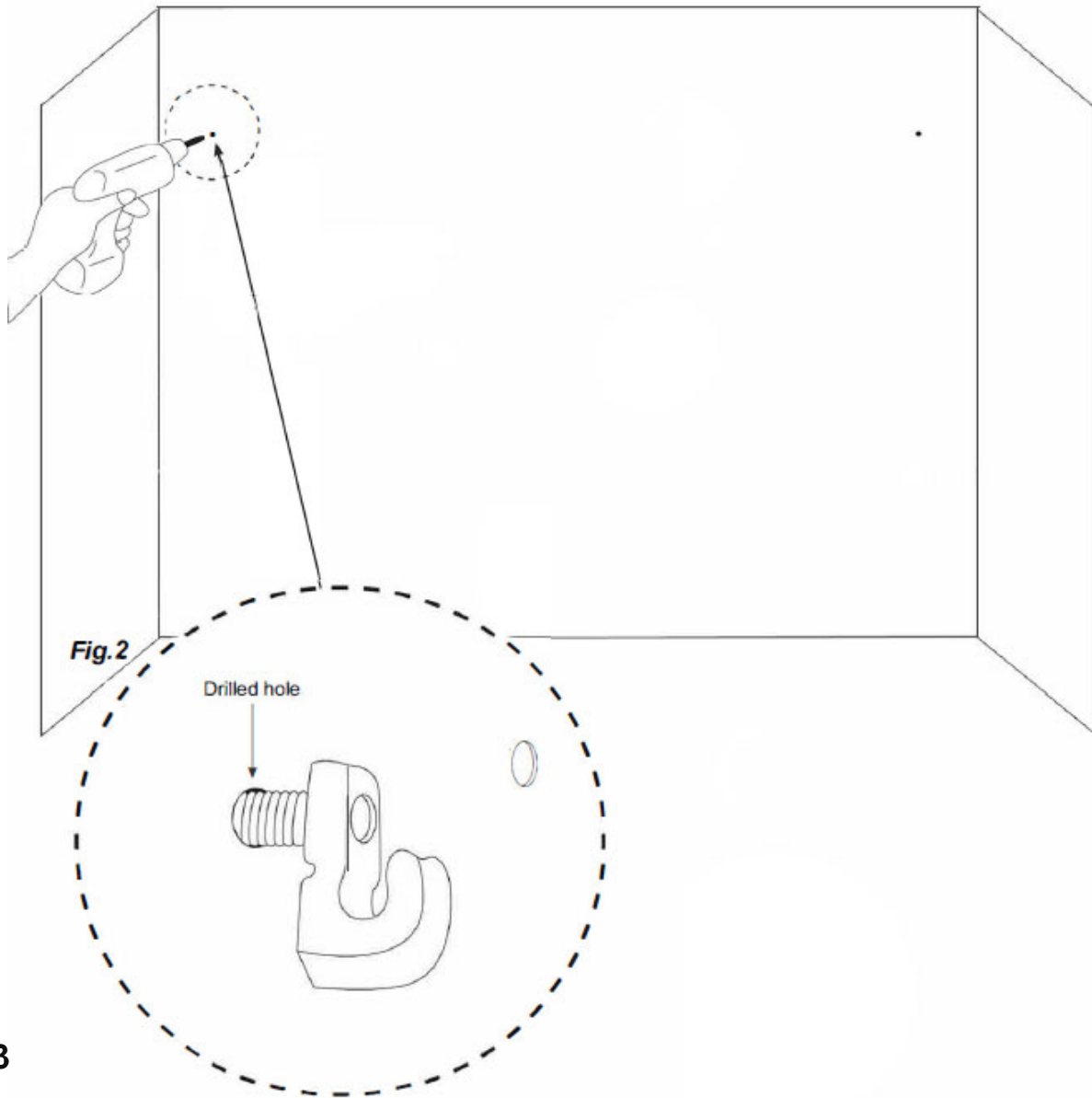

STEP 3

Push the **Back Wall Clips** half way into the holes as in **Fig 2**.

STEP 4

Hang the shelves flat against the wall over the **Back Wall Clips** in the correct position as shown in Fig 3.

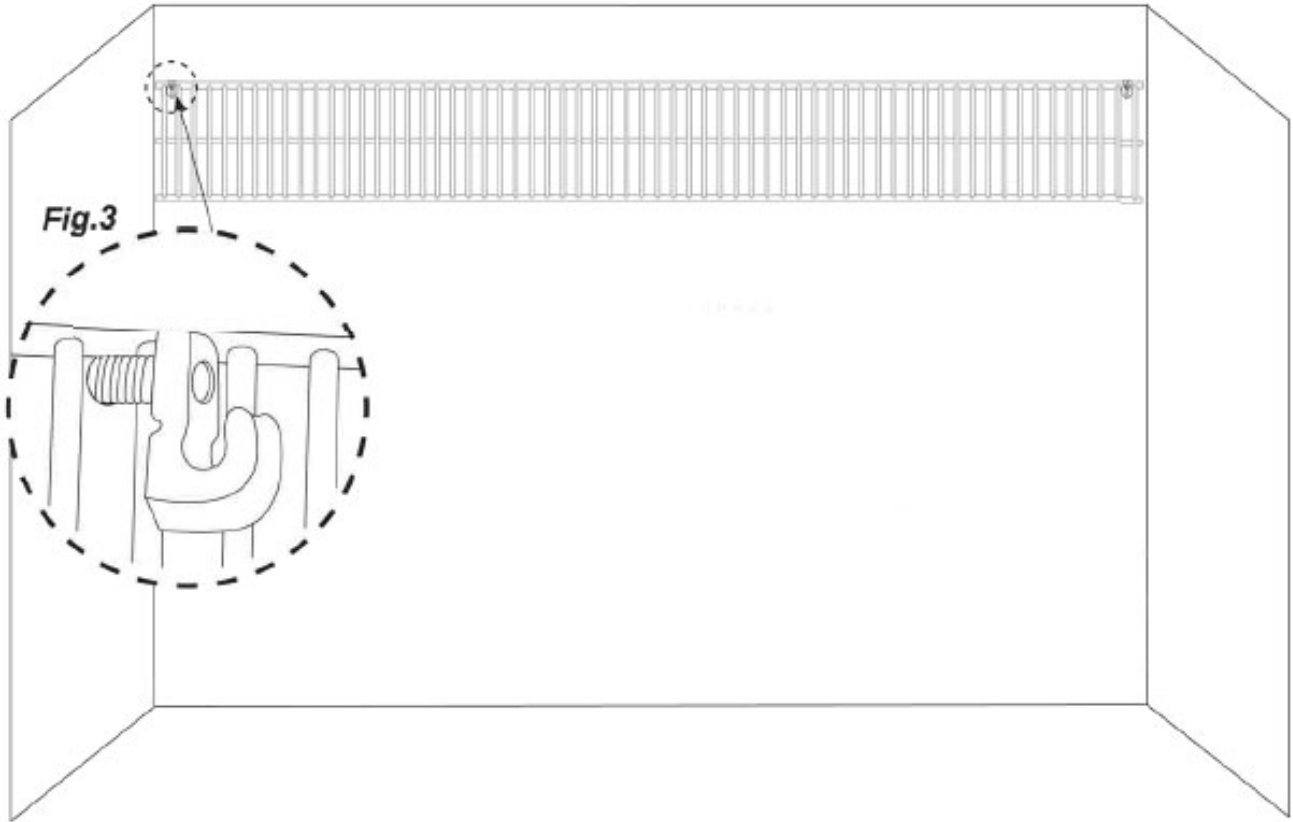

STEP 5 - DRILLING THE REMAINING HOLES.

Drill holes between the wire, 400mm apart. Remove the shelving.

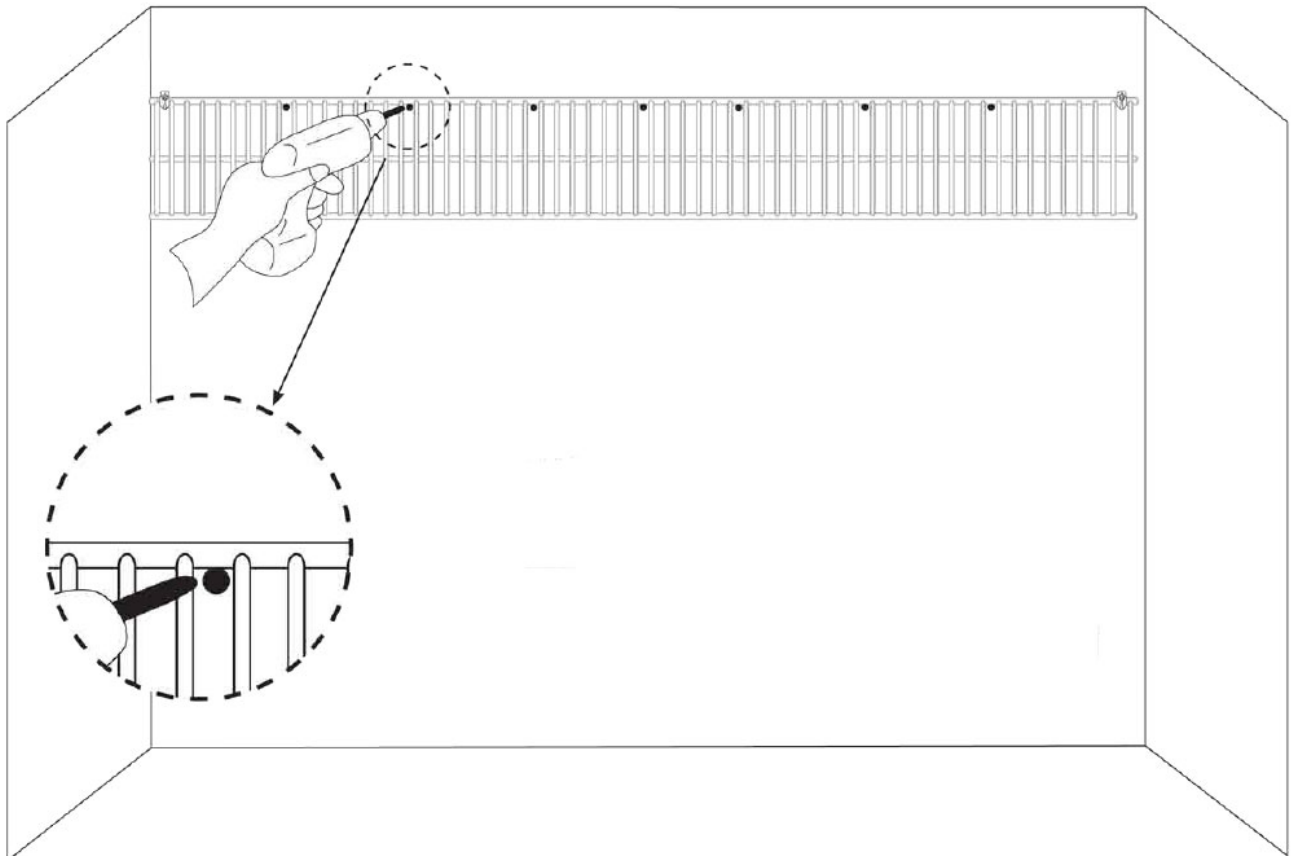

STEP 6 - FIXING THE BACK WALL CLIPS

Push the **Back Wall Clips** all the way into the holes and using a Drill, drill the screws in to tighten.

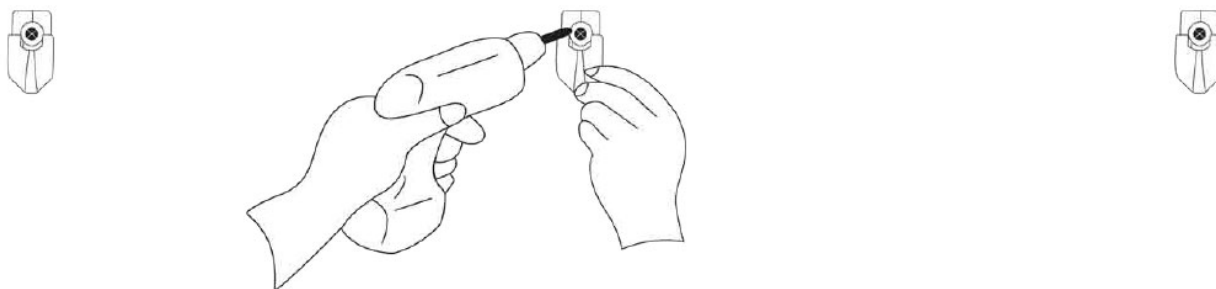

STEP 7 - CLIP THE SHELF IN

Fit the shelf into the **Back Wall Clips**.



STEP 8 - MARKING THE HOLES FOR THE END WALL BRACKET

Where the end of a shelf meets a wall, slide an **End Wall Bracket** into position and level the shelf.
Mark the wall through the holes of the **End Wall Brackets**.

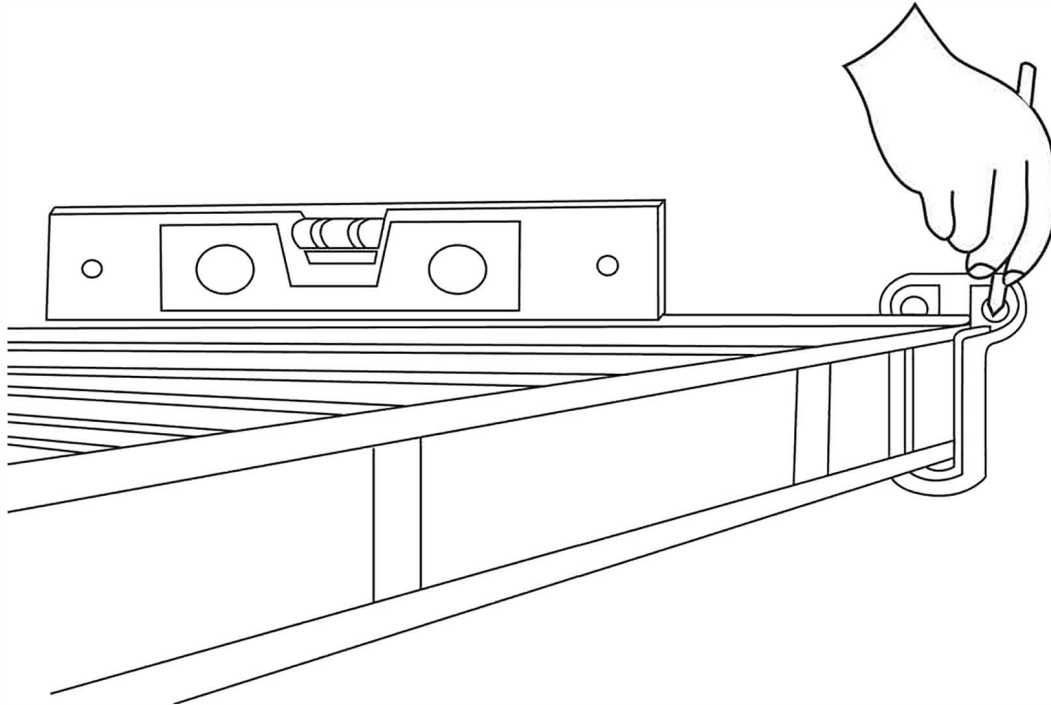

STEP 9 - DRILLING THE HOLES AND INSERTING THE WALL ANCHORS

Remove the **End Wall Bracket** and drill the holes over the marks.

Push the **Wall Anchors** into the holes as in Fig. 4.

Position the **End Wall Bracket** into place and drill into the wall anchors as in Fig. 5.

Fig.4

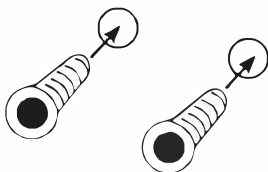
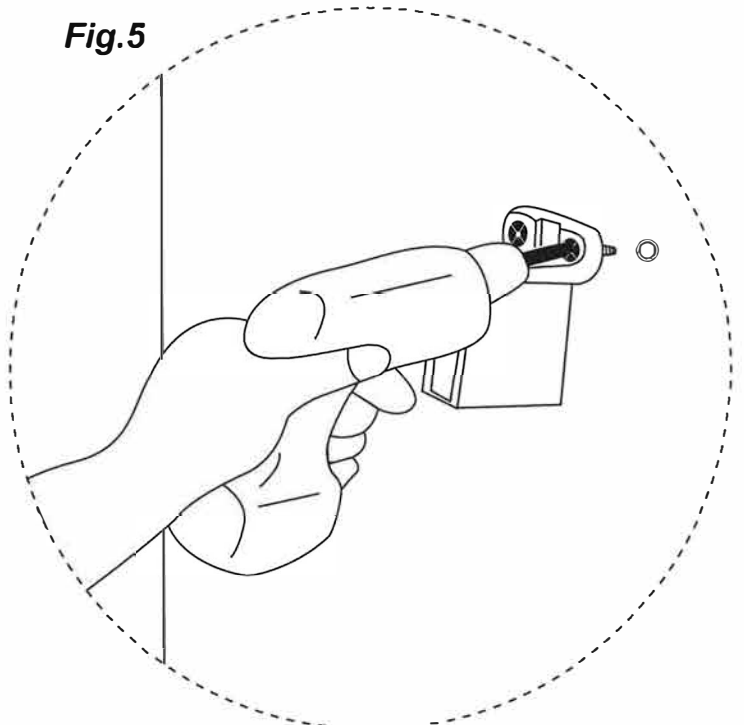
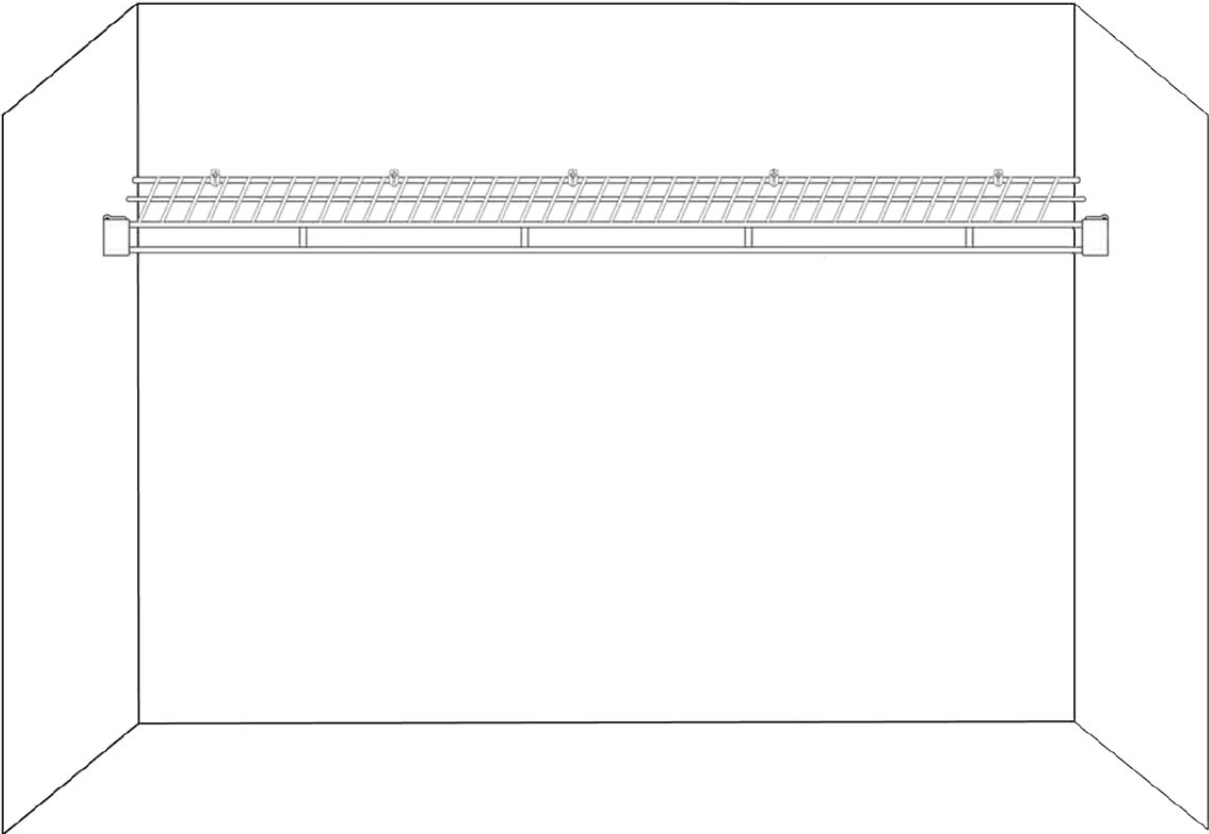

Fig.5



STEP 10

Check shelving is clipped securely into brackets



Please Note: If required, see following page for the Support Bracket Installation

SUPPORT BRACKET AND SADDLE CLIP INSTALLATION

Required in situations where shelf spans over 1200mm (1.2 m) long.

Support Bracket (Fig.1)

- Clip the **Support Bracket** to the front of the shelf. Ensure the shelf is level.
- Drill through the hole in the bottom of the bracket into the wall. Push a **Wall Anchor** into the hole.
- Fix the **Support Bracket** to the wall with a screw through both the Support Bracket and **Wall Anchor**.

Saddle Clip (Fig.2)

- We recommend finding a wall stud for extra strength
- Position the **Saddle Clip** over the shelf behind the **Support Bracket**.
 - Mark the holes where the **Saddle Clip** will be screwed to the wall, then drill holes.
 - Push the **Back Wall Anchors** into the holes.
 - Fix the **Saddle Clip** to the wall with screws through the **Saddle Clip** and **Wall Anchors**.

