

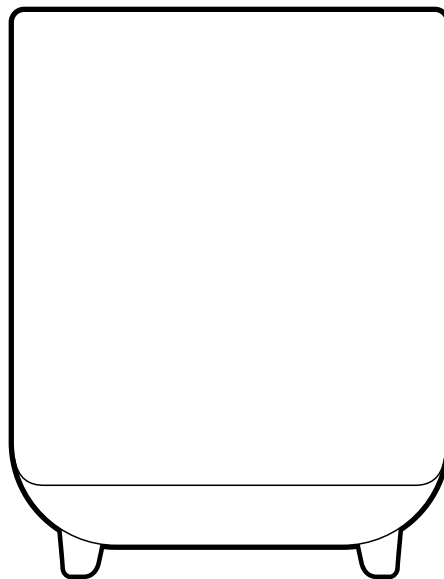

coway

Coway Air Purifier

APMS-0815C

Only available in the region where the rated voltage is correct.
Read and save these instructions.
English/German/French/Spanish/Italian



 This paper can be recycled.

FEATURES

| A smart air purifier for better quality sleep

Sleep mode offers a comfortable bedroom environment while the humidifier operates with less noise and the perfect humidity level for sleep. The added sleep light function helps you get a good night's sleep.

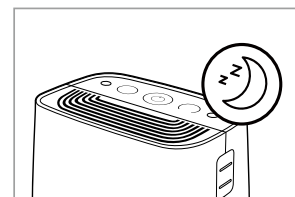

| Excellent air purification

A powerful HEPA filter eliminates airborne fine dust from indoor air, and the filter system is optimized to quickly remove contaminants.

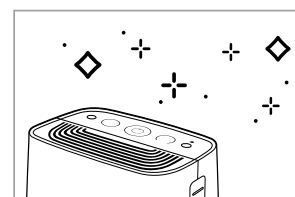

| Combined air purification/natural humidification

This product combines an air purification system which removes fine dust and harmful gases, and the natural humidification system provided with the humidifying filter.

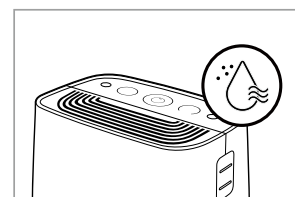

| Excellent humidification

The vaporizing humidification system has a capacity of over 450mL per hour.

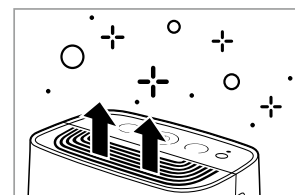

| 3-step automatic operation via the air quality sensor

The air quality sensor keeps you up to date on the indoor air contamination level in real time. When auto mode is on, the air speed is automatically controlled based on the surrounding contamination level to improve operating efficiency.

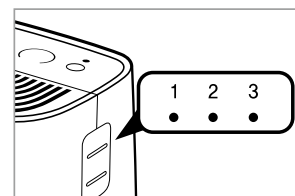

| Mood light feature

There is a convenient gentle mood light setting to help you sleep.

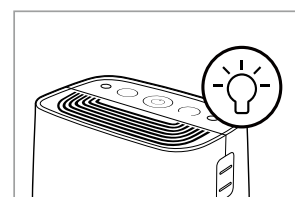

Thank you for using the **Coway air purifier**.
Please be sure to read this instruction manual to use and maintain your air purifier correctly.
If you experience any problems during use, you can refer to this instruction manual to resolve them. This user manual contains the product warranty, so please store it safely.

| CONTENTS

For Information

- | 03 | SAFETY INFORMATION
 - Danger
 - Warning
 - Caution
- | 07 | PARTS NAME
- | 08 | AIR PURIFICATION PROCESS

How to use

- | 09 | BEFORE USE
 - How to install filter
- | 11 | INDICATORS AND BUTTONS
- | 13 | HOW TO USE
- | 15 | ADJUST PARTICLE SENSOR
- | 16 | HOW TO ADD WATER

Maintenance

- | 17 | CLEANING METHOD
 - Product
 - Filter
- | 21 | FILTER REPLACEMENT

Others

- | 22 | NATURAL VAPORIZING HUMIDIFICATION METHOD
- | 23 | TROUBLE SHOOTING
- | 24 | PRODUCT SPECIFICATION
- | 25 | WARRANTY CARD

- Keep your instruction manual in a readily accessible or visible place. -

SAFETY INFORMATION

This is safety information. Be sure to follow it!

The warnings are to keep users safe and avoid damage to the product.
Please read them carefully and use the product correctly.



DANGER : FAILING TO FOLLOW THE PRECAUTIONS BELOW MAY RESULT IN SERIOUS INJURY OR EVEN DEATH.

- ⚠ Do not use damaged power plugs or loose sockets.
- ⚠ The power plug must be plugged into only 220 V – 240 V~ 50 Hz, 60 Hz sockets.
- ⚠ Do not pull on the power cord to move the device.
- ⚠ Do not touch the power plug with wet hands.
- ⚠ To avoid damaging or warping the power cord, do not use excessive force to bend the power cord or put heavy objects on top of it.
- ⚠ Do not repeatedly connect and disconnect the power plug.
- ⚠ If water enters the power supply, unplug the power and completely dry before using again.
- ⚠ Be sure to unplug the power during product repair, maintenance or part replacement.
- ⚠ If the power plug pins or contact area are covered in dust or water, cut off the power, wipe them clean and then dry before use.
- ⚠ Do not plug several electric appliances into one socket, and use only a dedicated socket.
- ⚠ Unplug the power when not used for a long time.
- ⚠ Do not carelessly connect or tamper with the power cord.
- ⚠ If the power cord is damaged, do not replace it yourself. Contact a service center to have it replaced.
- ⚠ Do not install near electric heaters.
- ⚠ Do not put on top of electric products like heaters or televisions.

- ⚠ Do not install in places with a lot of humidity or dust or places where water (rainwater) splashes.
- ⚠ Do not install near electric heaters.
- ⚠ Do not insert sharp objects such as picks into the air quality sensor.
- ⚠ If there is a strange sound, burning smell, or smoke from the device, immediately unplug the power plug and contact a service center.
- ⚠ Never immerse the product in water.
- ⚠ Do not spray flammable materials such as insecticides or air fresheners on the intake.
- ⚠ Do not open, repair or modify the purifier yourself.
- ⚠ Do not put bowls of water, chemicals, food, small metal objects, or flammable materials on top of the purifier.
- ⚠ Unplug the power before cleaning.
- ⚠ Do not spray water directly on the device or use benzene, thinners, etc. to wipe it during cleaning.
- ⚠ Do not excessively impact the outside of the water tank.
- ⚠ Fully empty the water tank and cistern before moving the purifier.
- ⚠ Do not use humidifier disinfectant (adjuvants).
- ⚠ Do not put fingers or foreign matter into the intake or outlet.

SAFETY INFORMATION



WARNING : FAILING TO FOLLOW THE PRECAUTIONS BELOW MAY RESULT IN CONSIDERABLE PHYSICAL INJURY OR PROPERTY DAMAGE.

- ⚠ Do not let children hang from or climb on the device.
- ⚠ Do not unplug by pulling on the power cord.
- ⚠ Plug into a power socket connected to an earth leakage circuit breaker (current sensitivity 30 mA or less).
- ⚠ If extending the power cord, only use with sockets and cords of 250 V / 15 A and use by itself.
- ⚠ Do not use in baths, showers, swimming pools, or other areas where the purifier may be in direct contact with water.

 **CAUTION : FAILING TO FOLLOW THE PRECAUTIONS BELOW MAY RESULT IN SLIGHT PHYSICAL INJURY OR PROPERTY DAMAGE.**

- ▲ Do not install on a slope.
- ▲ Do not excessively impact or use excessive force on this product.
- ▲ Use at least 20 cm away from walls or other objects on each side.
- ▲ Install the purifier in a place where it is not blocked on any side so air can circulate well.
- ▲ Install at least 2 m away from TVs and other electronic items.
- ▲ Do not use in BBQ or other restaurants with severe odor, smoke, or oil may occur.
- ▲ Do not install in direct sunlight.
- ▲ Replace the filter with a new one when the time comes.
- ▲ Periodically wash the pre-filter and dry it well in a shady place with good ventilation before use.
- ▲ Do not push or lean on the purifier. Otherwise, the device may fall over.
- ▲ Use with the rear cover, cistern, and water tank correctly installed.
- ▲ This appliance can be used by children aged from 8 years and above and persons with reduced physical, sensory or mental capabilities or lack of experience and knowledge if they have been given supervision or instruction concerning use of the appliance in a safe way and understand the hazards involved.
- ▲ It is advisable to supervise children so they do not play with the device.

READ AND SAVE THESE INSTRUCTIONS

PARTS NAME

| Front

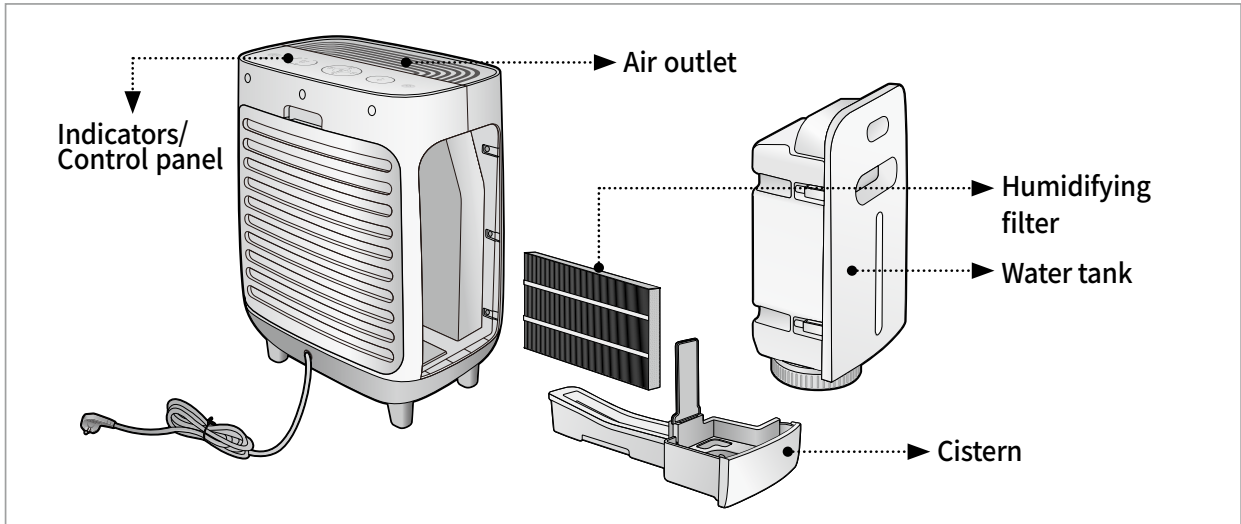

| Rear

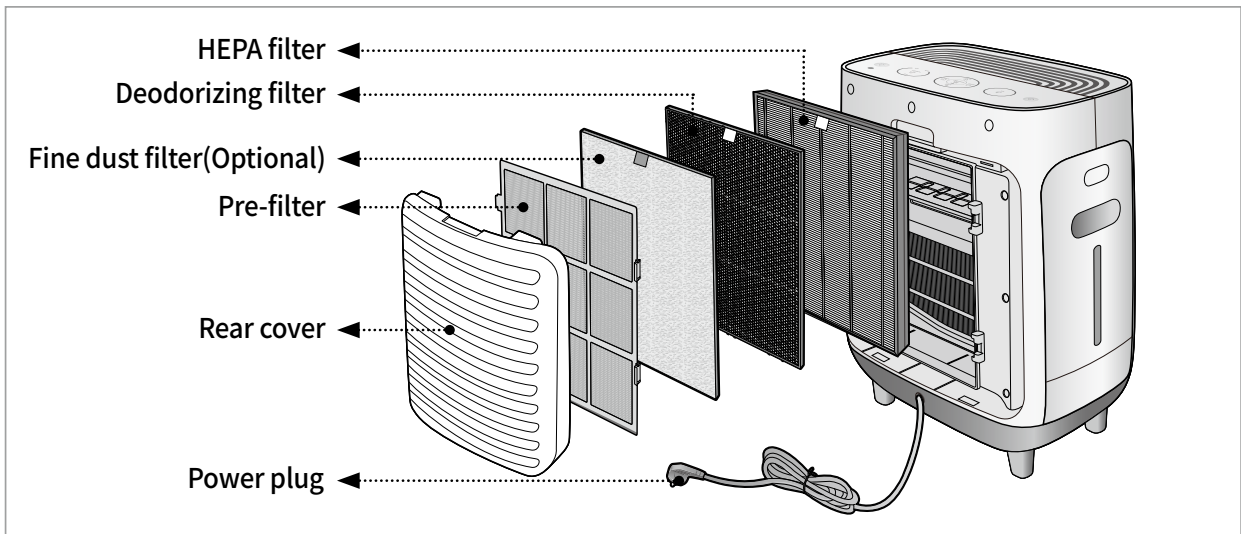

| Parts

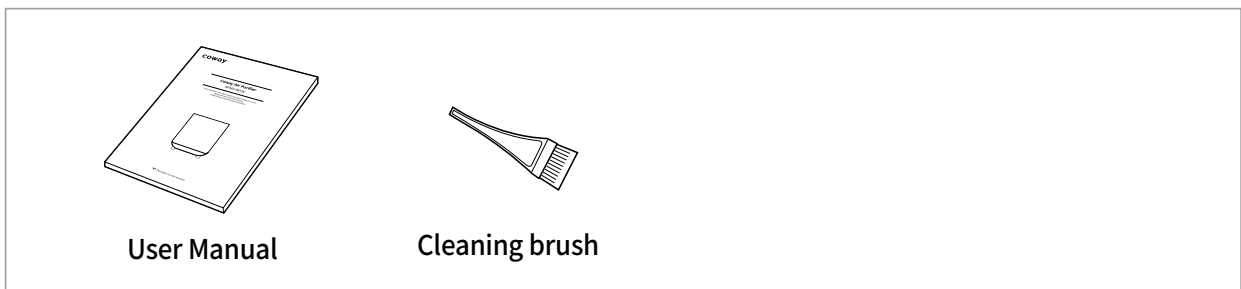

AIR PURIFICATION PROCESS

For Information

| Pre-filter

Removes large dust and mold, hair, pet fur, etc.

| Fine dust filter(Optional)

This filter is placed in front of the deodorizing filter to catch fine dust, fur, etc. and protects the deodorizing and HEPA filters.

| Deodorization filter

The granular activated carbon deodorizing filter effectively removes odors including food smells and unpleasant household odors and harmful gases.

| HEPA filter

The high-performance HEPA filter is excellent at removing cigarette smoke and fine dust.

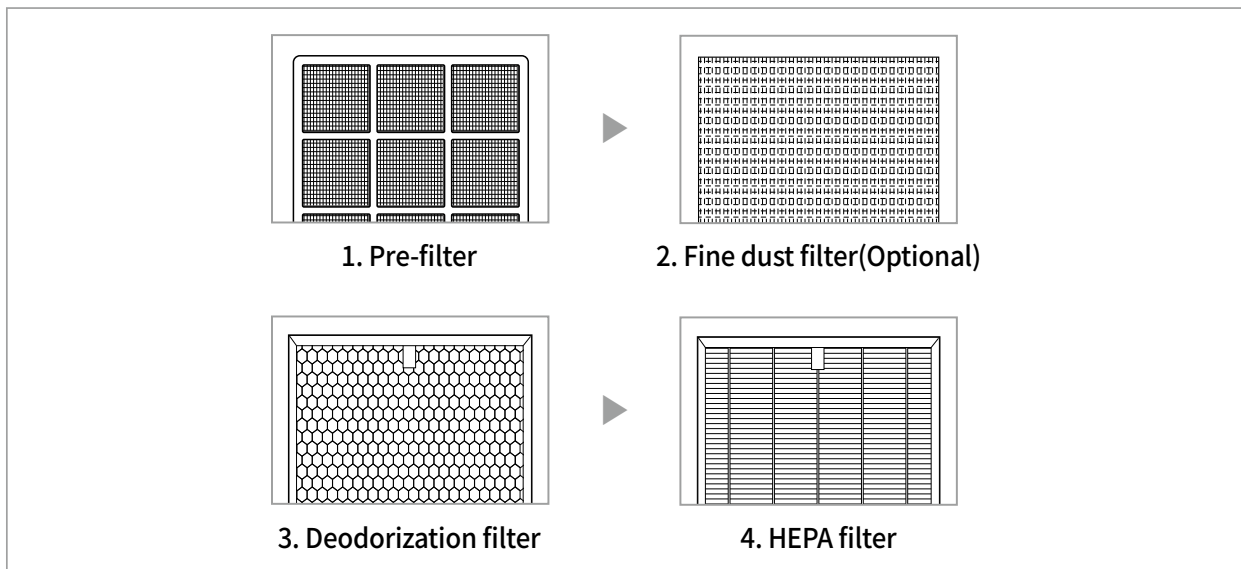

HUMIDIFICATION/PURIFICATION PROCESS

| Water tank

Stores 2.3 L of water.

| Cistern

Keeps the water level and volume supplied to the humidifying filter at a set level.

| Humidifying filter

This component has a wide surface area to transmit moisture through the passages through which dry, purified, filtered air passes and can rapidly absorb water to humidify naturally.

* Coway Humidifying Filter is treated with preservatives (Zinc pyrithione) to protect the filter from the growth of mold and bacteria and prolong filter life.

BEFORE USE

| Please check before use!

⚠ The product is for 220 V – 240 V~ 50 Hz, 60 Hz only.

Only plug the power plug into sockets of 220 V – 240 V~ 50 Hz, 60 Hz.

| How to install filter



Tips

- Be sure to install the filter after removing the plastic packaging.
 - This product is for household use. Only use it indoors.
 - When not in use, remove the power plug from the socket.
 - When assembling filters, check the front of the filters.
- ▶ Filter order : Pre-filter → Fine dust filter(Optional) → Deodorizing filter → HEPA filter

1. Open the rear cover.

Pull the upper part of the rear cover to open.

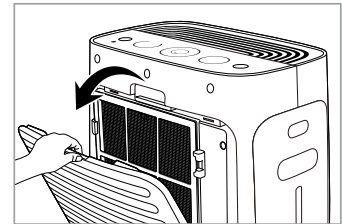

2. Take out the filter and remove the plastic packaging.

Remove the plastic packaging from filters, excluding the pre-filter, and assemble them in the purifier in order.

* Filter assembly order : HEPA filter → Deodorization filter → Fine dust filter(Optional) → Pre-filter

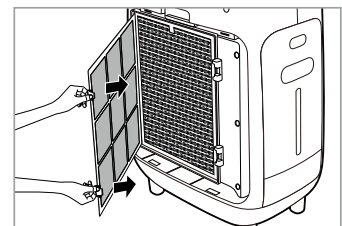
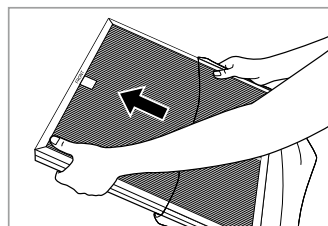

3. Install the rear cover.

Put the 2 tabs on the bottom part of the rear cover into their slots and push to install.

* If the rear cover is not properly installed, the product will not operate.

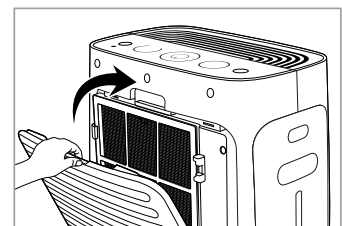
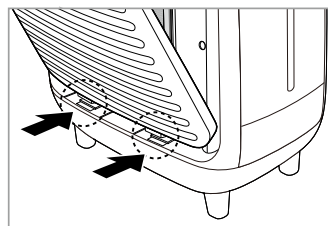

| Humidifying filter

1. Remove the water tank.

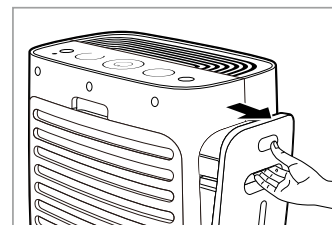

2. Lift and pull the cistern upward as in the picture to remove.

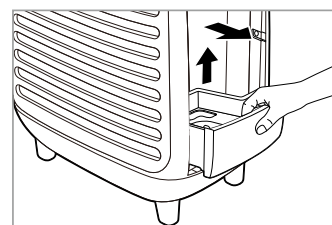

3. Remove the plastic packaging from the humidifying filter and then install.

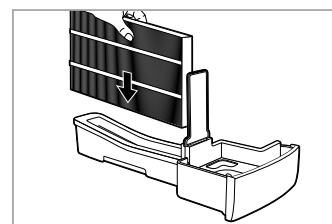

4. Assemble the cistern and water tank in order.

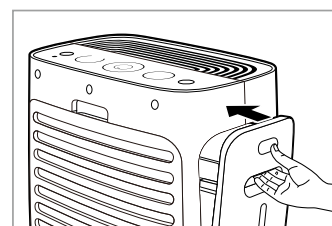
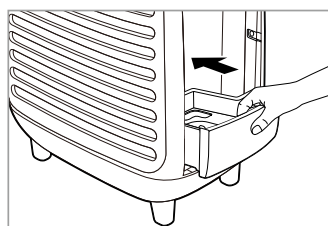

Tips

- If there is scaling on the humidifying filter, less humidity may be supplied. Clean at least once per week. (See p. 19)
- If the cistern and water tank are not installed correctly, the purifier may not work.

INDICATORS AND BUTTONS

| Indicators

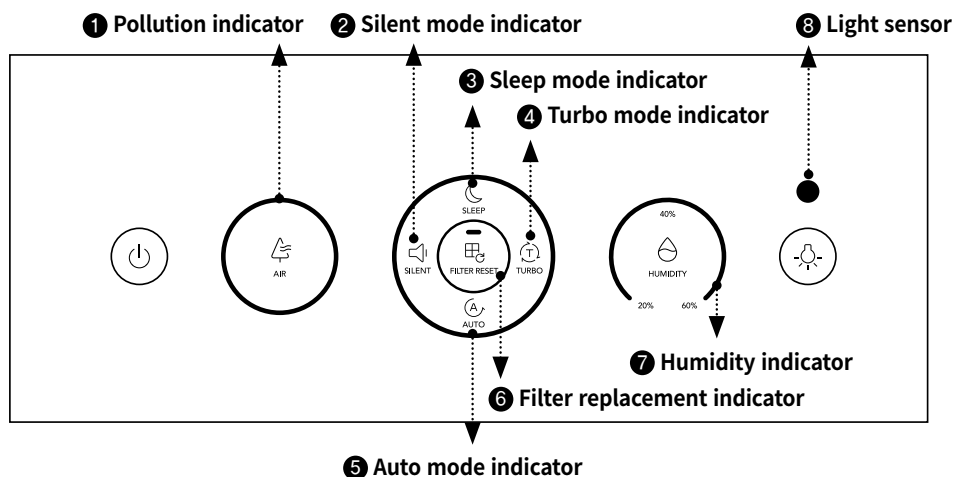

- 1 Air quality indicator**
Indicates the contamination level of surrounding air in four stages: red, violet, mauve, and blue.



- 2 Silent mode indicator**
Turns on/off when silent mode is on/off.



- 3 Sleep mode indicator**
Turns on/off when sleep mode is on/off.

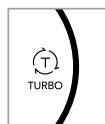

- 4 Turbo mode indicator**
Turns on/off when turbo mode is on/off.

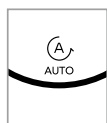

- 5 Auto mode indicator**
Turns on/off when auto mode is on/off.

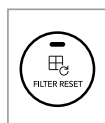

- 6 Filter replacement indicator**
This indicator is illuminated when it is time to replace the filters

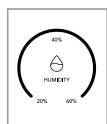

- 7 Humidity indicator**
Indicates the surrounding humidity. (20%-60%)

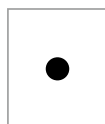

- 8 Light sensor**
Detects the surrounding level of light.

| Buttons

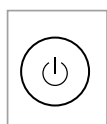
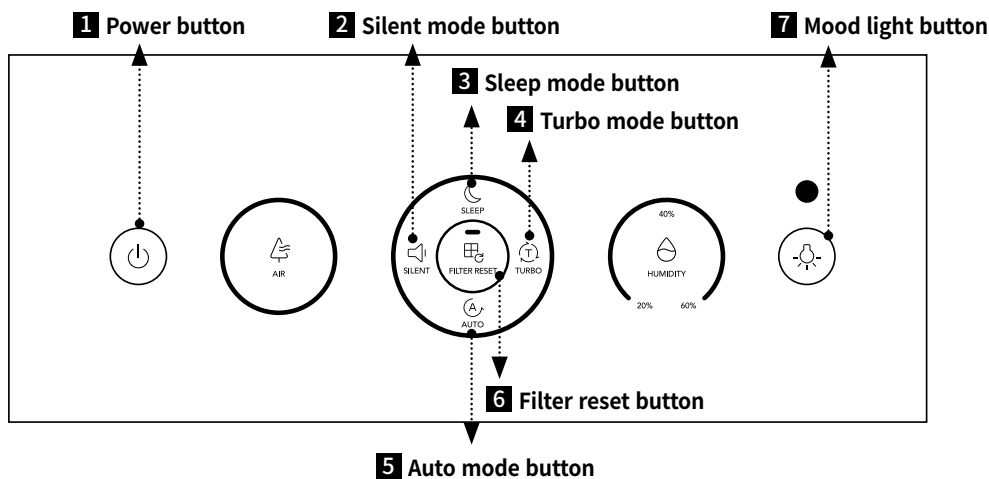

1 Power button

Use when turning the purifier on and off.

* The purifier begins operating in auto mode the first time, and if it is turned off and on again while in operation, runs in the mode it was in before it stopped.



2 Silent mode button

Turns silent mode on/off.



3 Sleep mode button

Turns sleep mode on/off.

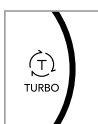

4 Turbo mode button

Turns turbo mode on/off.



5 Auto mode button

Turns auto mode on/off.



6 Filter reset button

Pressing 3 seconds resets the filter change interval.

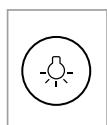

7 Mood light button

Turns the mood light on and off. Each time the mood light button is pressed, indicators are turned on and off in the order of : Mode indicator ON → All indicators OFF → Lower mood light ON → All indicators ON.

HOW TO USE



Tips

- Plug the power plug into a socket before operating the purifier.
- When the purifier is turned on, it starts in auto mode by default.

| Silent mode

Minimizes air speed during purification and humidification/purification to create a quiet, comfortable environment. This operating mode is quiet and consumes less power.

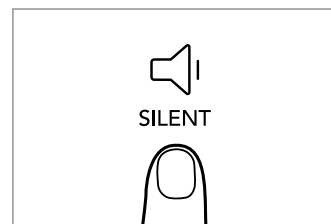

| Sleep mode

Maintains the nearby humidity level for eight hours to create a comfortable environment. The mood lighting at the bottom of the purifier slowly dims over 20 minutes after it is turned on to help you drift off to sleep.

Only the air purification feature works when there is no water in the water tank.



| Turbo mode

Maximizes air speed during purification and humidification/purifier to rapidly create a comfortable environment.

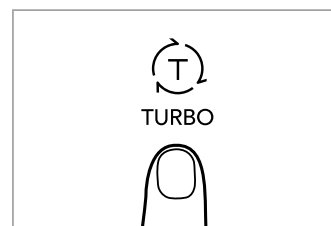

| Auto mode

Operates effectively by automatically adjusting the purifier's air speed (level 1 → level 2 → level 3) depending on the indoor contamination level detected by the sensor. This is a convenient operating mode for most users.

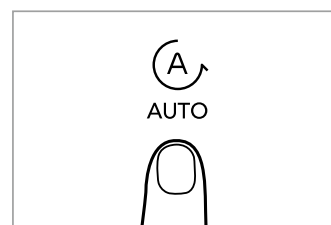

	Pollution level 1	Pollution level 2	Pollution level 3 or more
Air speed	Level 1	Level 2	Level 3

| To use humidification/purification

If water is put into the water tank during air purification and the water tank is put in the purifier, it automatically converts to humidification/purification.

- * The sensor automatically recognizes when water is put in the water tank and switches to humidification/purification. When the sensor detects that there is no water, the purifier automatically converts to air purification without humidification.

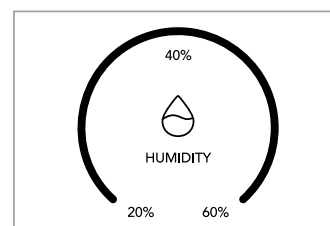

| To use mood lighting

Press the mood light button to turn the mood light and other indicators on or off.

Each time the mood light button is pressed, indicators are turned on and off in the order of : Mode indicator ON → All indicators OFF → Lower mood light ON → All indicators ON.

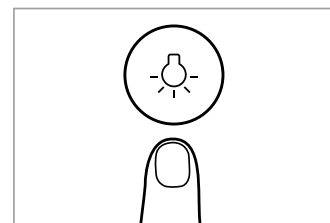

ADJUST PARTICLE SENSOR

| How to adjust the sensitivity of the pollution sensor

1. Press and hold the turbo mode/silent mode buttons for at least 3 seconds while the purifier is operating.

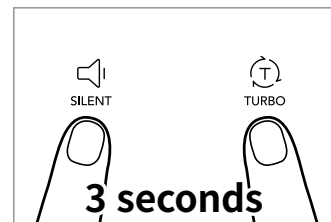

2. Filter replacement indicator blinks for about 0.5 seconds.

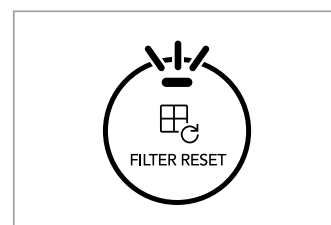

3. Press the auto mode button to adjust to your desired sensor sensitivity.
The sensor sensitivity is expressed via the blinking of the humidity indicator.

2 bars illuminated	5 bars illuminated	8 bars illuminated
Sensitive	Normal	Less sensitive

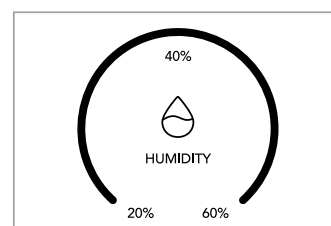
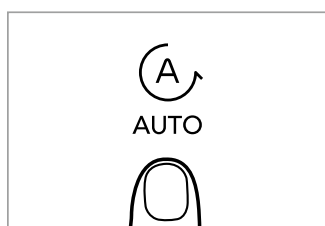

4. Press the turbo mode and silent mode buttons simultaneously for at least 3 seconds again, and the purifier operates normally at the input sensor sensitivity.

* If there is no button input for 10 seconds, that value is automatically entered.

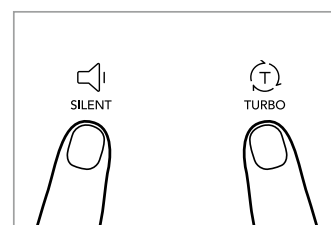

3 seconds

HOW TO ADD WATER

| Filling up the water tank

1. Press the PUSH button on the side of the purifier and pull the handle to remove the water tank.

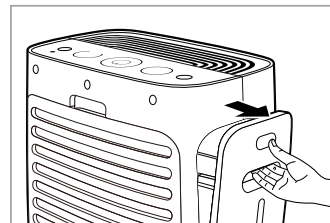

2. Turn the water tank cap in a counter-clockwise direction to detach.

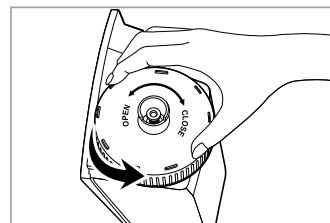

3. Put in water and turn the water tank cap in a clockwise direction until you hear a click as it locks.

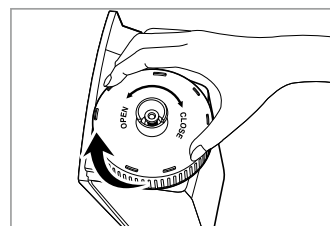

| Warnings when reinserting the water tank

When inserting the water tank into the purifier, push until you hear a click.

If the water tank is not completely installed, it may cause leaks or faulty operation.

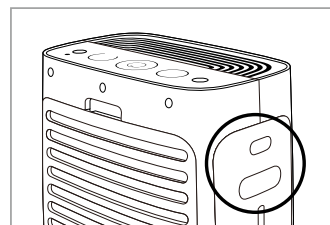
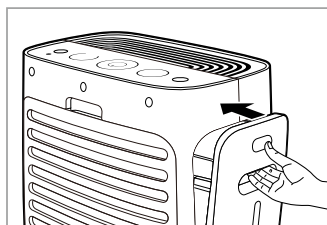

CLEANING METHOD



Tips

- Always unplug the power before cleaning.
- Do not use detergents containing organic solvents (solvents, thinners, etc.), bleach, chlorine, or abrasives to clean.
- Do not immerse the purifier in water or sprinkle water on it.

| Cleaning the pollution sensor (clean every 2 months)

1. Open the air quality sensor cover on the left of the purifier. Clean off dust from the air inlet, outlet, and air quality sensor with a soft brush or vacuum cleaner.

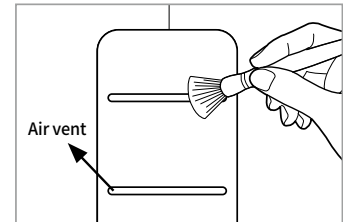

2. Wet a cotton swab with a small amount of water and wipe the lens, dust inlet, and outlet, then wipe again with a dry cotton swab to remove moisture.

- * If cleaning is not done regularly, the performance of the air quality sensor may decrease.
- * The cleaning cycle differs depending on the purifier's surroundings. Clean more often in dusty environments.

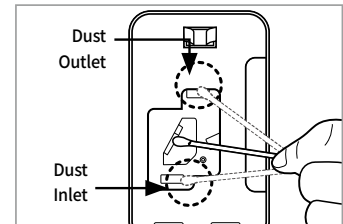
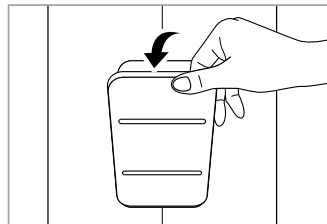

| Cleaning the air inlet and outlet (clean every 2 months)

Clean the air inlet and outlet with a soft brush.

- * Take care that dust does not fall inside the purifier while cleaning.

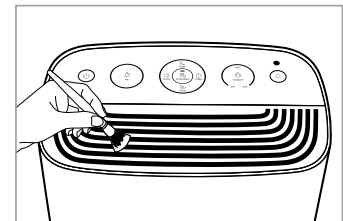

| Cleaning the rear cover

Remove the rear cover from the purifier and then wipe away dust stuck to the surface with a soft, dry cloth or soft brush.

- * If there is severe contamination, use a damp cloth (do not use abrasives).

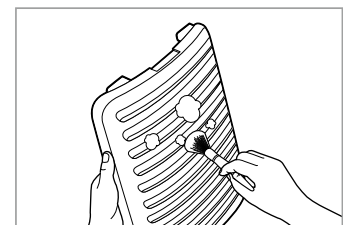

| Cleaning the purifier itself (clean every 2-4 weeks)

Wipe with a soft, dry cloth.

- * If there is severe contamination, use a damp cloth (do not use abrasives)

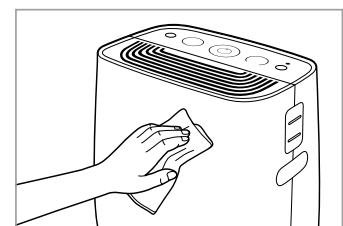

| Cleaning the water tank (clean daily)

1. Remove the water tank from the side of the purifier and then turn the water tank cover located at the bottom of the water tank in a counter-clockwise direction to open. If there is water left in the water tank, discard it before cleaning.

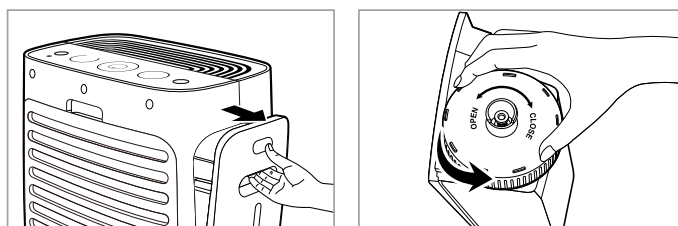

2. Fill the water tank to about 1/3 and put in a small amount of neutral detergent. Turn the water tank cover in a clockwise direction to close. Hold the water tank with both hands as in the following picture and shake from left to right so all sides of the water tank can be washed.

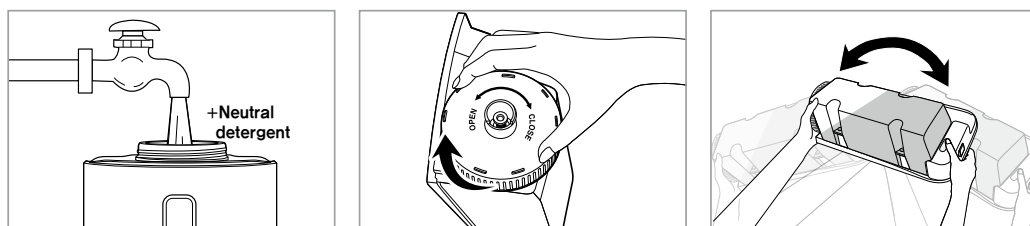

3. Turn the water tank cover in a counter-clockwise direction to open and discard the water mixed with detergent, then rinse well in running water.washed.

- * Do not excessively impact the water tank exterior. There is a risk of damage if there is excessive impact. This can cause water leaks.
- * When tightening the cap, close it in a clockwise direction until you hear a click to lock it.
- * If the water tank cap is not completely closed, it may cause leaks or faulty operation.
- * After using a neutral detergent, wash well so no residue remains. Otherwise, performance may decrease.

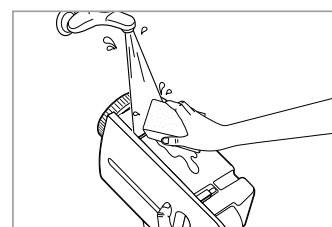

4. Dry the water tank in a shady place until it is completely dry, then put it back in the purifier.

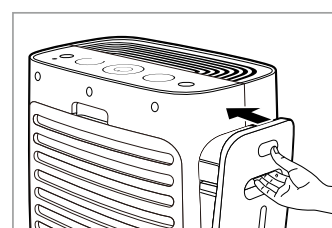

CLEANING METHOD

| Cleaning the cistern (daily)

1. Remove the water tank from the purifier and then pull the cistern out from the purifier side as in the picture to remove.

* If cleaning is not done regularly, the performance of the air quality sensor may decrease.

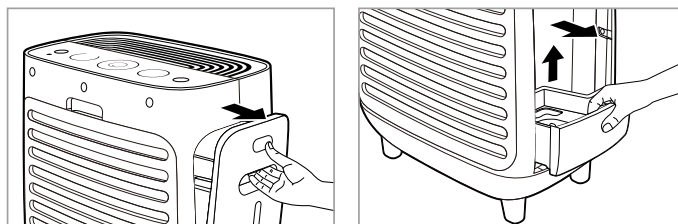

2. Carefully remove the humidifying filter from the cistern.

* When removing the humidifying filter, water absorbed by it may drain. Be careful. Soak the humidifying filter in lukewarm water (no more than 40°C) for at least 20 minutes, then use a cleaning brush to gently clean in running water.

* Depending on the environment, tap water may leave a white mineral residue on the humidifying filter as it dries. Clean in running water and dry.

* The period and tendency of mineral residue may differ depending on the environment.

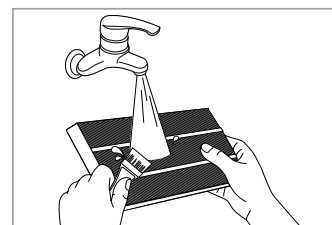

3. Remove the humidifying filter, shield, and cistern cover from the cistern in order and then wet a soft cloth or cleaning brush in neutral detergent and wipe the cistern under running water. Wipe away moisture from the cistern with a soft, dry cloth and dry in a shady place.

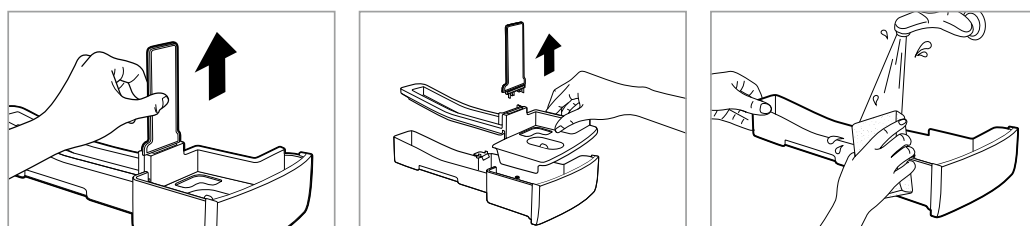



Tips

- Always unplug the power plug before cleaning the filters.
- The pre-filter can be reused after removing dust and cleaning with water.
- If the pre-filter is not cleaned for a long time, the product performance may decrease and problems may occur.
- The Fine dust filter(Optional), deodorizing filter, and HEPA filter cannot be reused after cleaning. Never clean them with water.

| Pre-filter (clean every 2-4 weeks)

1. Hold the upper part of the rear cover and pull to open.

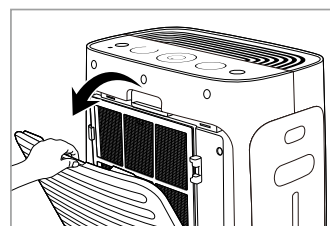

2. Push the pre-filter handle to take out.

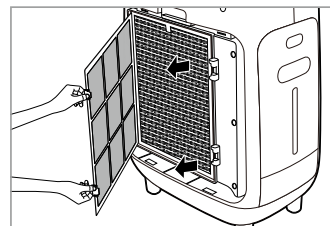

3. Remove dust with water or a vacuum cleaner depending on the degree of contamination.

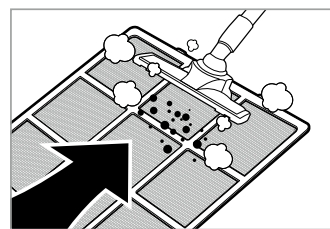

4. Dry all moisture on the pre-filter before reinstalling it in the purifier. Put the rear cover back on the purifier.

- * When installing the pre-filter in the purifier, be sure to attach it exactly on the hook.
- * Wash the pre-filter in running water or water with a neutral detergent dissolved in it (about 30°C) and then completely dry it in a shady place with a cross-breeze. If it is dried in direct sunlight or near a dryer, heater, or other heat-generating items, it may be warped and not work in the purifier.

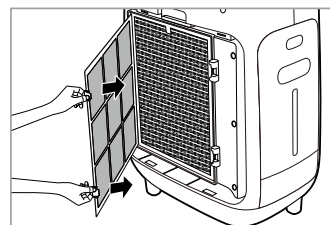

FILTER REPLACEMENT

Maintenance

| How to replace

- During filter assembly, be sure to check the front.
- Only use genuine Coway filters to keep the purifier at its optimal performance.
- Always unplug the power plug before replacing filters.

| Filter cleaning and replacement cycle

Filter	Cleaning/replacement time	Cleaning/replacement
Pre-filter	Once / 2-4 weeks	Clean and wash
Fine dust filter(Optional)	Once / 4 months	Replace
Deodorizing filter	Once / 12 months	Replace
HEPA filter	Once / 12 months	Replace
Humidifying filter	Once / week	Clean and wash
	Once / 4 months	Replace

| How to replace air purifier filters

Check the front of the HEPA filter before replacing it.
* Use it only after removing the plastic packaging.

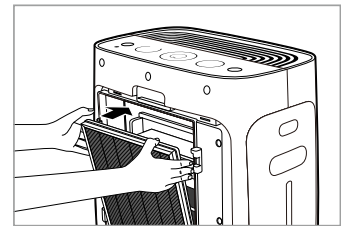

| How to replace the humidifying filter

1. Remove the water tank from the purifier and then pull the cistern out from the purifier side to remove.

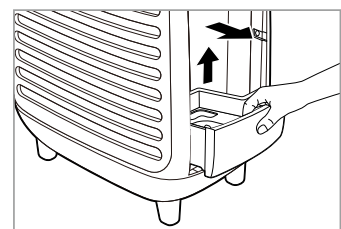

2. Carefully remove the humidifying filter so water doesn't splash, and then replace it.

* Use it only after removing the plastic packaging.

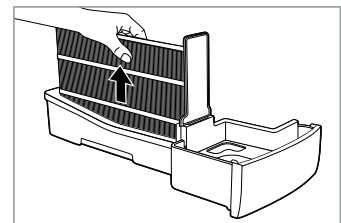

NATURAL VAPORIZING HUMIDIFICATION METHOD

| Operating mechanism

The humidification method adopted by this product is a natural vaporization humidification type. The humidification part consists of three parts: the water tank, the water tray and the WICK filter. The water tank supplies water to the water tray and the WICK filter installed in the water tray absorbs water. The dry air that is sucked into the product turns into humid air as it passes through the holes of the WICK filter and the humid air humidifies the room air.

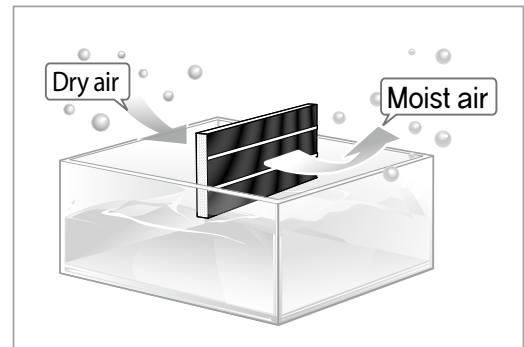

- * As the warm, dry air passes the WICK filter, it acquires moisture and loses heat. Because the airflow from the product is colder than it was, you may feel that the air is cold depending on the size or temperature of the room.
- * The amount of moisture supplied by a natural vaporization humidification type varies depending on the surrounding temperature or humidity. Therefore if the humidity is high or the temperature is low, the amount of moisture supplied by the humidification function may be low.

| Advantages

Humidifiers using the ultrasonic wave method can only humidify the area around them as the water particles are big and heavy, and if they are run for a long time, their surroundings become damp. The natural vaporizing method, on the other hand, evaporates water the same way as in nature, so the water particles are too small to see and very light. They don't irritate the respiratory system or dampen the inside of a house, and users can enjoy balanced humidification effects through the inside of their homes.

- * This product is for 25-square-meter areas, and may not be able to detect humidity changes in larger areas. (To increase humidity in wide areas, run humidification/purification using at least air volume level 3.)

TROUBLESHOOTING

The product may not operate correctly for trivial reasons or due to unfamiliar methods of use that are not product malfunctions. In such cases, the problem can be solved easily without the help of a service center if the following items are checked. If the problem is not resolved even after checking the following, please contact a service center.

Problem	Check	Possible Solutions
There is no breeze.	• Is the power plugged in?	Plug the power cord into a 220 V - 240 V~ 50 Hz, 60 Hz socket.
	• Is the entire display off?	Press the power button, then select your desired function.
	• Is there a power failure?	After the power comes back on, use the purifier.
	• Is the water tank not fully in place?	Ensure the water tank is installed all the way.
Air speed doesn't change.	• Is the purifier operating manually?	Turn on your desired operating mode.
	• Is the purifier operating on silent mode?	Air speed is set at minimum during silent mode.
There is considerably less air speed than when I first used the purifier.	• Is it past time to clean or replace the filters?	Check your filter cleaning and replacement cycle and clean or replace filters.
There's a smell from the air vent.	• Is it past time to clean or replace the filters?	Check your filter cleaning and replacement cycle and clean or replace filters.
The air quality indicator always shows the same color.	• Is there dust on the dust sensor lens?	Clean the dust sensor lens.
	• Does the dust pollution level continuously appear high?	Set the dust sensor sensitivity to insensitive or standard.
	• Does the dust pollution level continuously appear low?	Set the dust sensor sensitivity to sensitive or standard.
The pollution level indicator flashes.	• Request service.	
If other functional defects occur	• Check the problem, then unplug the power and contact or request service.	
The humidity indicator is blinking.	• Is the water tank not fully installed?	Ensure the water tank is installed all the way.

PRODUCT SPECIFICATIONS

Others

Product name	Air purifier
Model name	APMS-0815C
Rated voltage	220 V - 240 V~ 50 Hz, 60 Hz
Phase	Single-phase
Power consumption	Purification: 29 W, humidification/purification: 24 W
Product insulation grade	Class 2 device <input type="checkbox"/>
Dust collection method	Mechanical dust intake (HEPA filter)
Safety equipment	Power is shut down when the front cover is opened
Installation location	For indoor use
water tank capacity	2.3 L
Humidification	450 mL/h
Product size	410.7 mm (width) x 271.5 mm (depth) x 514.6 mm (height)
Net weight	10 kg

- ▶ Specifications may vary slightly without prior notice to improve product performance.
- ▶ The recommended usage area data was specified with the humidifying filter installed.
- ▶ The power consumption data was specified with the humidifying filter installed.

**WARRANTY CARD OR WARRANTY LETTER
TWO YEAR LIMITED WARRANTY
AIR PURTFIER APMS-0815C(“PRODUCT”)**

Model:

Serial Number:

Customer Name:

(“OWNER”)

Date of Purchase:

What This Warranty Covers:

commencing with the date of purchase of the Product and continuing for a period of Two years, if manufacturing defects in the Product cause the Product to not operate properly for its intended use, then subject to the exclusions, conditions, and limitations contained herein, COWAY at its sole option will repair or replace the Product.

Decisions as to the extent of repair or replacement required will be made solely by COWAY.

The remedy under this Warranty is available only for that portion of the Product exhibiting defects at the time of the warranty claim. The replacement Product as well as any remaining original Product will be warranted only for the original two years warranty period. This limited warranty applies only to Product used for an application specified by COWAY for the Product and applied in strict accordance with COWAY published specifications in effect at the time of application. IF PRODUCT IS USED FOR OTHER THAN ITS INTENDED PURPOSE, IT IS SOLD AS IS AND WITHOUT ANY EXPRESS

OR IMPLIED WARRANTIES, INCLUDING OF MERCHANTABILITY OR FITNESS FOR A PARTICULAR PURPOSE.

What This Warranty Does Not Cover:

This Warranty warrants that the Product will be free from manufacturing defects which affect the ability of the Product to operate for its intended use; it is not a warranty that the Product will never require repairs or to undertake responsibilities, liabilities or obligations other than those specifically identified in the preceding section. COWAY is not responsible or liable for personal injury or property damage of any kind, even if arising from a breach of this Warranty.

Limitations and Exclusions:

TO THE EXTENT PERMITTED BY APPLICABLE LAW, COWAY DISCLAIMS ANY OTHER WARRANTY EXPRESS OR IMPLIED, THAN THAT PROVIDED FOR HEREIN. THIS WARRANTY IS IN LIEU OF AND EXCLUDES ALL OTHER WARRANTIES, GUARANTEES, CONDITIONS AND REPRESENTATIONS, EXPRESS OR IMPLIED, ORAL OR WRITTEN, STATUTORY OR OTHERWISE, INCLUDING BUT NOT LIMITED TO ANY IMPLIED CONDITIONS OR WARRANTIES AS TO THE MERCHANTABILITY OR FITNESS FOR A PARTICULAR PURPOSE OF THE COWAY PRODUCT. SOME STATES DO NOT ALLOW LIMITATIONS ON HOW LONG AN IMPLIED WARRANTY LASTS, SO THE ABOVE LIMITATION MAY NOT APPLY TO YOU. COWAY DOES NOT AUTHORIZE ANY PERSON INCLUDING ITS REPRESENTATIVES, TO MAKE ANY REPRESENTATION OR TO OFFER ANY WARRANTY, CONDITION OR GUARANTY IN RESPECT OF THE PRODUCT OTHER THAN THIS WARRANTY. THIS LIMITED WARRANTY SHALL BE THE OWNER’S SOLE AND EXCLUSIVE REMEDY AGAINST COWAY AND COWAY SHALL NOT BE LIABLE FOR ANY CONSEQUENTIAL, EXEMPLARY, SPECIAL, INCIDENTAL OR OTHER DAMAGES INCLUDING, BUT NOT LIMITED TO, LOSS OF PROFITS, AND LOSS OF USE. INCIDENTAL, CONSEQUENTIAL AND EXEMPLARY DAMAGES SHALL NOT BE RECOVERABLE EVEN IF THE REMEDIES OR THE ACTIONS PROVIDED FOR IN THIS WARRANTY FAIL OF THEIR ESSENTIAL PURPOSE. SOME STATES DO NOT ALLOW THE EXCLUSION OR LIMITATION OF INCIDENTAL OR CONSEQUENTIAL DAMAGES, SO THE ABOVE LIMITATION OR EXCLUSION MAY NOT APPLY TO YOU. COWAY SHALL NOT BE LIABLE FOR ANY DAMAGES WHICH ARE BASED UPON NEGLIGENCE, BREACH OF WARRANTY, STRICT LIABILITY OR ANY OTHER LEGAL THEORY OF LIABILITY OTHER THAN THE EXCLUSIVE LIABILITY SET FORTH IN THIS WARRANTY.

Limitations on Implied Warranties:

Any implied warranty of merchantability or fitness for a particular purpose or use, shall be limited to the duration of the foregoing express written warranty.

Conditions of Warranty:

COWAY's continuing liability under this Warranty is conditioned upon the following:

- a) The defect or damage is not caused by or is the result of: abnormal use or conditions; improper storage, unauthorized modifications or repair; misuse, neglect, accident, alteration, improper installation or other acts that are not the fault of Coway or the manufacturer of the product or that are not covered by the manufacturer's warranty;
- b) The Product has not been altered, modified or repaired without prior written approval of COWAY;
- c) The OWNER has notified COWAY in writing of any failure of the Product covered by this Warranty within thirty (30) days following such failure;
- d) There has been no misuse, abuse or negligence with respect to the Product on the part of the OWNER.

Waiver:

COWAY's failure at any time to enforce or rely upon any of the terms or conditions stated herein shall not be construed to be a waiver of its rights hereunder.

Obtaining Warranty Service and OWNER'S Duties:

If the Product fails to operate for its intended purpose, then notify COWAY or its Representative Agency, within 48 hours or within the next business day after discovery of any defect in the Product. The OWNER must give written notice to COWAY no later than thirty (30) days after a defect is discovered or should by reasonable diligence have been discovered. Claims under this Warranty will require proof of purchase by the OWNER

COWAY
Add : COWAY Co., Ltd. 136-23, Yugumagoksa-ro, Yugu-eup, Gongju-si, Chungcheongnam-do, Korea Tel. : Korea-Seoul : +82-1588-5100

COWAY EU
Tel. : UK - London : +44 2032807197 GERMANY - Hamburg : +49 4087406758 FRANCE - Paris : +33 170120004 ITALY - Milan : +39 0236003045 SPAIN - Madrid : +34 911234181 Mail : info_eu@coway.com Web : de.coway.com

POLAND
Add : OPUS SP. z o.o. Toruńska 8, 44-122 Gliwice Tel. : +32 4201255 Mail : serwis@opus.pl

SWEDEN
Add : Albion Nordic AB Traktorgatan 2 745 37 Enköping Sweden Tel. : +46 171 66 33 00 Mail : info@albionnordic.com Web : www.albionnordic.com