

Coway Air Purifier

AP-2015F

This product is for domestic use only. It cannot be used in overseas countries where the power voltage is different.
Warranty card is included in this user's manual.
Read and save these instructions.
English/German/French/Spanish/Italian

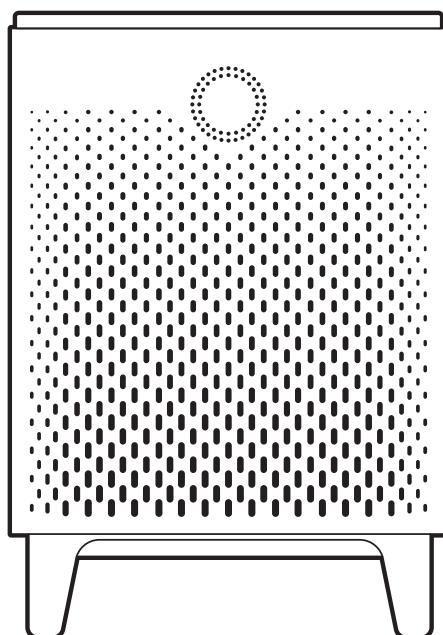

FEATURES

| Real-time Air Quality Monitoring

Airmega's pollution sensor tells you the indoor air quality in real-time. The brightly colored LED ring lets you know if your indoor air is fresh or unhealthy every minute of the day.

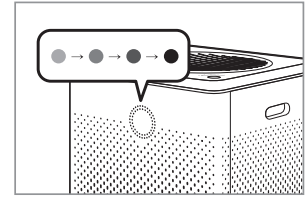

| Smart Mode

With Smart Mode, Airmega adapts to its surroundings. Fan speeds automatically adjust based on the room's air quality and room conditions.

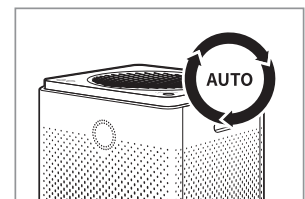

| Max2 Filter

The Max2 filter (an activated carbon filter plus GreenHEPA™ filter) reduces more than 99% of volatile organic compounds (VOCs), odors such as NH₃, CH₃CHO. It also captures and reduces up to 99.97 % of airborne particles in the air such as pollen, pollution, and other allergens.

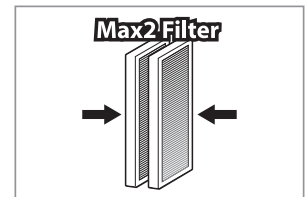

| Filter Lifetime Notifications

With status alerts for the Max2 Filters and the Pre-filters, you'll know when it's time to replace them. And because the Airmega gauges how much air has traveled through it, you can be sure the notifications are accurate.

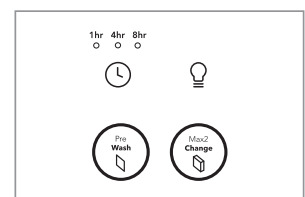

Thank you for using the **Coway air purifier**.
Please be sure to read this instruction manual to use and maintain your air purifier correctly.
If you experience any problems during use, you can refer to this instruction manual to resolve them. This user manual contains the product warranty, so please store it safely.

| CONTENTS

For Information

- | 03 | SAFETY INFORMATION
 - Danger
 - Warning
 - Caution
- | 07 | PARTS NAME
- | 09 | AIR PURIFICATION PROCESS

How to use

- | 10 | BEFORE USE
 - How to install filter
- | 11 | INDICATORS AND BUTTONS
- | 13 | INSTALLATION
- | 14 | HOW TO USE
- | 16 | ADJUST PARTICLE SENSOR

Maintenance

- | 17 | CLEANING METHOD
 - Product
 - Filter
- | 19 | FILTER REPLACEMENT

Others

- | 21 | TROUBLE SHOOTING
- | 22 | PRODUCT SPECIFICATION
- | 23 | WARRANTY CARD

- Keep your instruction manual in a readily accessible or visible place. -

SAFETY INFORMATION

Please follow the instructions as they are for your safety.

Please read this information to ensure your safety and prevent property damage.
Please read the cautions carefully and use the product correctly.







DANGER : FAILING TO FOLLOW THE PRECAUTIONS BELOW MAY RESULT IN SERIOUS INJURY OR EVEN DEATH.

- ⚠ Do not use a damaged power plug or loose electric outlet.
- ⚠ The power plug must be plugged into only 220 V - 240 V~ 50 Hz, 60 Hz sockets.
- ⚠ Do not pull on the power cord to move the product.
- ⚠ Do not touch the power plug with wet hands.
- ⚠ To avoid damaging or warping the power cord, do not use excessive force to bend the power cord or put heavy objects on top of it.
- ⚠ Do not repeatedly connect and disconnect the power plug.
- ⚠ If water enters the power supply, unplug the power and completely dry before using again.
- ⚠ Be sure to unplug the power during product repair, maintenance or part replacement.
- ⚠ If the power plug's pins or contact area become covered in dust or water, wipe them thoroughly.
- ⚠ Do not plug several electric appliances into one socket, and use only a dedicated socket.
- ⚠ Unplug the power when not used for a long time.
- ⚠ Do not carelessly connect or tamper with the power cord.
- ⚠ If the supply cord is damaged, it must be replaced by the manufacturer, its service agent or similarly qualified persons in order to avoid a hazard.
- ⚠ Do not install near electric heaters.
- ⚠ Do not put on top of electric products like heaters or televisions.
- ⚠ Do not install in places with a lot of humidity or dust or places where water (rainwater) splashes.













- ⚠ Do not use or store combustible gases or flammable materials near this product.
- ⚠ If there is a strange sound, burning smell or smoke from the purifier, immediately unplug the power plug and contact a service center.
- ⚠ Never immerse the product in water.
- ⚠ Do not spray flammable materials such as insecticides or air fresheners on the intake.
- ⚠ Do not open, repair or modify the purifier yourself.
- ⚠ Do not put bowls of water, chemicals, food, small metal objects, or flammable materials on top of the purifier.
- ⚠ Clean after unplugging the power.
- ⚠ Do not spray water directly on the purifier or use benzene, thinners, etc. to wipe it during cleaning.
- ⚠ Do not insert sharp objects such as picks into the pollution sensor.
- ⚠ Do not put fingers or foreign matter (pins, sticks, coins, etc.) into the outlet.
- ⚠ Do not let children hang from or climb on the purifier.
- ⚠ Be careful that children do not put their hands in the outlet.
- ⚠ Be careful that children do not put their hands into the hole of the product.
- ⚠ Replace the filter with a new one when the time comes.
- ⚠ Do not spray water directly on the purifier.
- ⚠ This appliance has a polarized plug (one blade is wider than the other). To reduce the risk of electric shock, this plug is intended to fit in a polarized outlet only one way. If the plug does not fit fully in the outlet, reverse the plug. If it still does not fit, contact a qualified electrician. Do not attempt to defeat this safety feature.
- ⚠ Do not operate any fan with a damaged cord or plug. Discard fan or return to an authorized service facility for examination and or repair.
- ⚠ Do not run cord under carpeting. Do not cover cord with throw rugs, runners, or similar coverings. Arrange cord away from traffic area and where it will not be tripped over.

SAFETY INFORMATION

 **WARNING : FAILING TO FOLLOW THE PRECAUTIONS BELOW MAY RESULT IN CONSIDERABLE PHYSICAL INJURY OR PROPERTY DAMAGE.**

-  Do not unplug by pulling on the power cord.
-  Do not use in baths, showers, swimming pools, or other areas where the purifier may be in direct contact with water.
-  Children shall not play with the appliance.
-  Cleaning and user maintenance shall not be made by children without supervision.

 **CAUTION : FAILING TO FOLLOW THE PRECAUTIONS BELOW MAY RESULT IN SLIGHT PHYSICAL INJURY OR PROPERTY DAMAGE.**

-  Do not unplug the power or move the purifier while it is operating.
-  If unusual sound, odor, or smoke comes from the purifier, immediately unplug the power and call our service center.
-  Do not install on a slope.
-  Do not excessively impact or use excessive force on this product.
-  Use at least 20 cm away from walls or other objects on each side.
-  Install the purifier in a place where it is not blocked on any side so air can circulate well.
-  Do not use in BBQ or other restaurants where odor, smoke, or oil may occur.
-  Do not use in direct sunlight.
-  Do not install in a high place.
-  Do not touch the controls while power is turning on.
-  Do not use extreme force on the purifier.
-  Do not push or lean on the purifier. The purifier may fall over.
-  Do not use the product for any purpose other than air purification.

- ⚠ Do not let a person be exposed to breeze expelled from the purifier front for a long time.
- ⚠ Do not allow breeze expelled from the purifier front near your face.
- ⚠ Do not use for a long time in places that are sealed or where children, the elderly or sick are.
- ⚠ Do not block the outlet with laundry or curtains.
- ⚠ Remove dust from the pre-filter with a vacuum cleaner or water.
- ⚠ Periodically wash the pre-filter and dry it sufficiently in a shady place with good ventilation.
- ⚠ Do not repeatedly push the flow mode or high-speed care mode buttons.
- ⚠ This appliance can be used by children aged from 8 years and above and persons with reduced physical, sensory or mental capabilities or lack of experience and knowledge if they have been given supervision or instruction concerning use of the appliance in a safe way and understand the hazards involved.
- ⚠ Do not allow children to play with the plastic wrapping and product.

READ AND SAVE THESE INSTRUCTIONS

PARTS NAME

| Front / Back

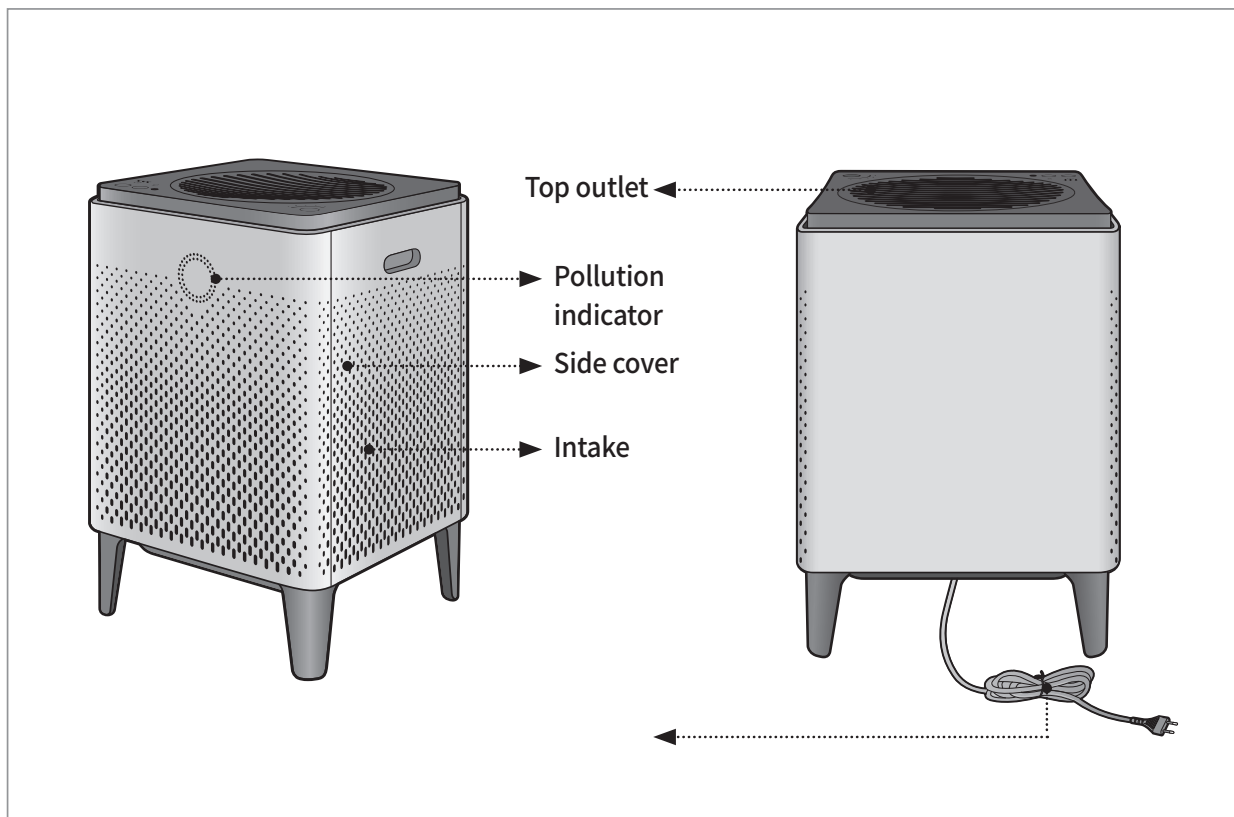

| Top

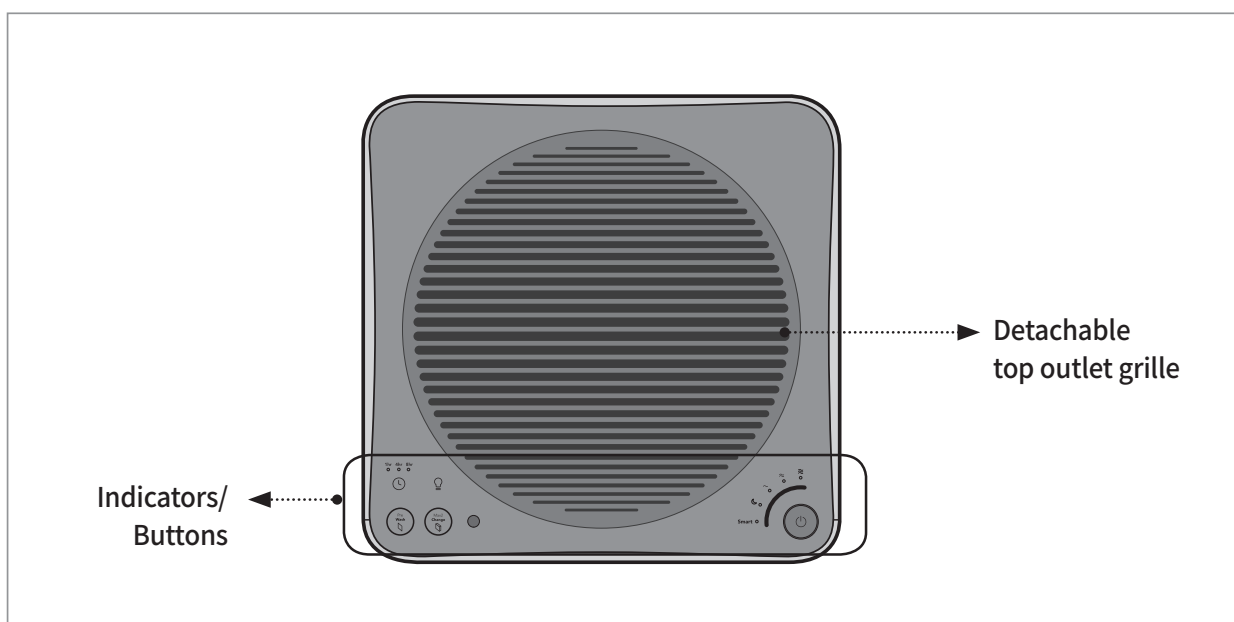

| Parts



User Manual

AIR PURIFICATION PROCESS

| Pre-filter

Captures large particles like hair, fur, and dust by micro mesh.

| Max2 filter (Activated Carbon + GreenHEPA™)

Captures and reduces more than 99 % of VOCs and odors such as NH₃, CH₃CHO. It also captures and reduces up to 99.97 % of airborne particles, allergens, and contaminants down to 0.3 microns in size.

* Coway GreenHEPA™ filters are treated with preservatives (Silver sodium hydrogen zinc phosphate and thiabendazole) to protect the filter from the growth of mold and bacteria and prolong filter life.

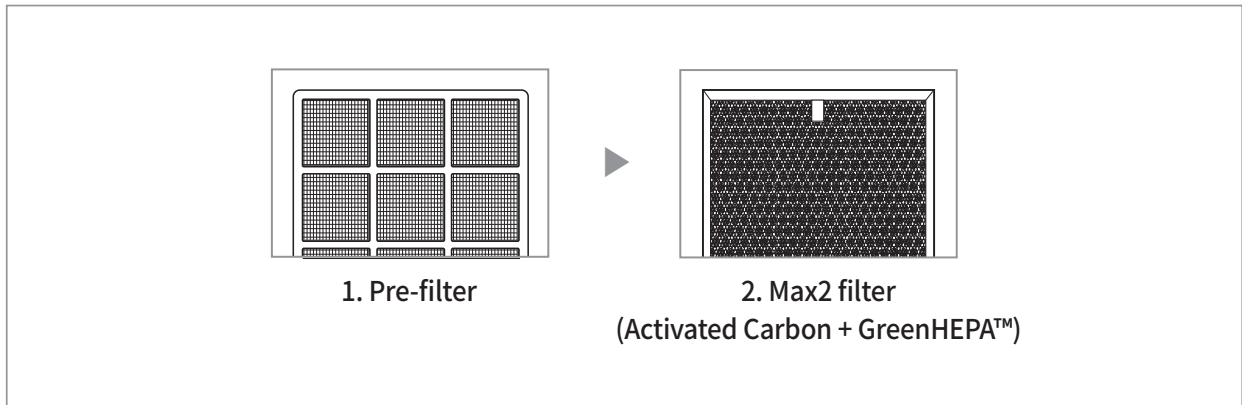

| Please check before use!

⚠ The product is for 220 V – 240 V~ 50 Hz, 60 Hz only.

Make sure to connect the power plug to a grounded electric outlet (220 V – 240 V~ 50 Hz, 60 Hz) dedicated to the product.

| How to install filter



Tips

- Be sure to install the filter after removing the plastic packaging.
- Only use it indoors.
- When not in use, remove the power plug from the socket.
- During filter assembly, check the front of the filters.

▶ Filter assembly order : Max2 filters → Pre-filters → Covers

1. Open the side cover.

Pull the upper part of the side cover to open.

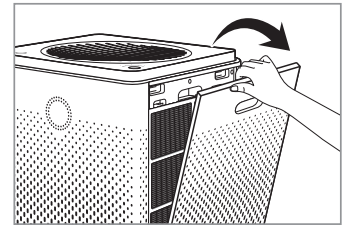

2. Take out the filter and remove the plastic packaging.

Remove the plastic packaging from filters, excluding the pre-filter, and assemble them in the purifier in order.

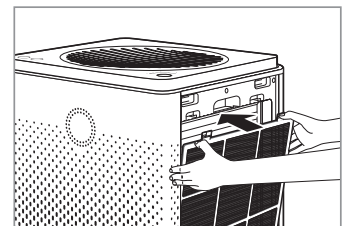
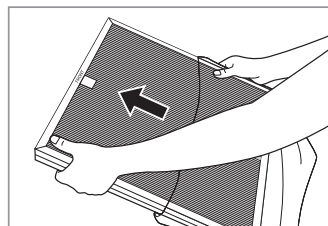

- * Filter assembly order :
Max2 filters → Pre-filters → Covers

3. Reattach the side cover.

Fit the two tabs on the bottom part of the side cover into their slots and push to install.

- * If the side cover is not properly attached, the product will not operate.

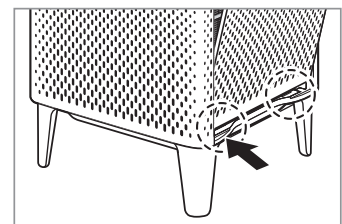

INDICATORS AND BUTTONS

| Indicators

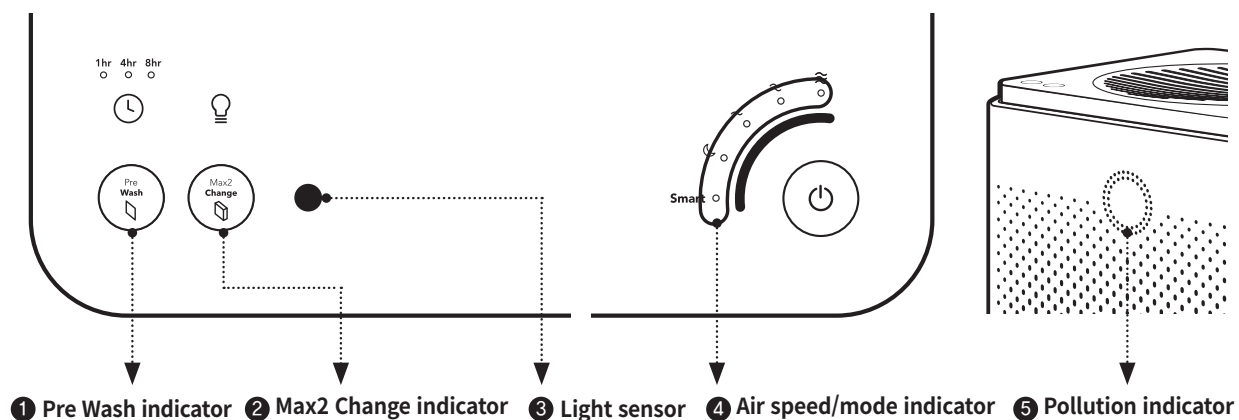

1 Pre Wash indicator

Shows the pre-filter cleaning cycle at 5 levels (100 %, 80 %, 60 %, 40 %, 20 %, 0 %).

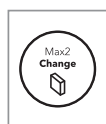

2 Max2 Change indicator

Shows the Max2 filter lifetime at 5 levels (100 %, 80 %, 60 %, 40 %, 20 %, 0 %).

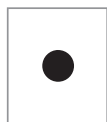

3 Light sensor

This sensor detects the intensity of light. When the product is set to Smart mode and it is dark, for 3 minutes, the product enters Sleep mode automatically. However, if the air speed is set manually or pollution level is above normal (in Smart mode), Sleep mode will not be activated automatically.

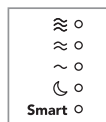

4 Air speed/mode indicator

Displays current fan speed and mode.

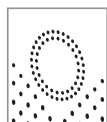

5 Pollution indicator

Indoor Pollution is shown by LED color.

Air Quality	LED Color
Good	Blue
Moderate	Purple
Unhealthy	Pink
Very Unhealthy	Red

| Buttons

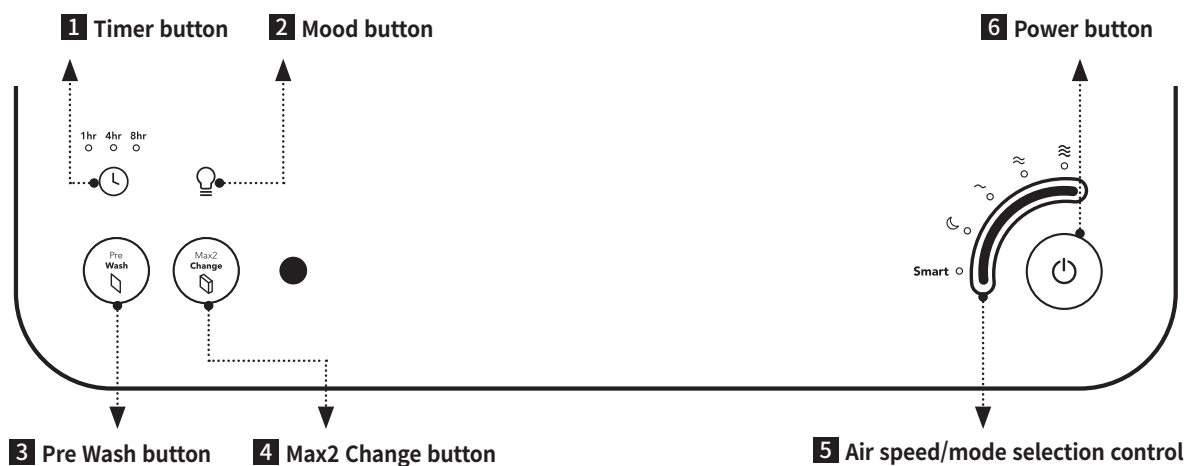

1 Timer button

Touch this button to automatically turn off after an hour, 4 hours, or 8 hours.



2 Mood button

Touch this button to turn the air quality indicator and light on or off.



3 Pre Wash button

When the letters on button is lit, it indicates that the pre-filters need to be cleaned.

* After cleaning the pre-filters, touch and hold this button for 2~3 seconds to reset the indicator.

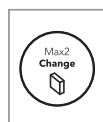

4 Max2 Change button

When the letters on button is lit, it indicates that the Max2 filters need to be replaced.

* After replacing the Max2 filters, touch and hold this button for 2~3 seconds to reset the indicator.

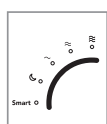

5 Air speed/mode selection control

Touch the sensor to select the air speed or set the product to Smart mode or Sleep mode.

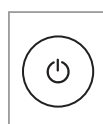

6 Power button

Touch this button to turn the product on. Touch and hold this button for 2~3 seconds to turn the product off.

INSTALLATION

| Connecting the Power and Turning On the Air Purifier



- This product is for 220 V - 240 V~ 50 Hz, 60 Hz use only. Make sure your power supply meets these requirements.

1. Insert the power plug into a power outlet.

The indicators on the air purifier will blink.

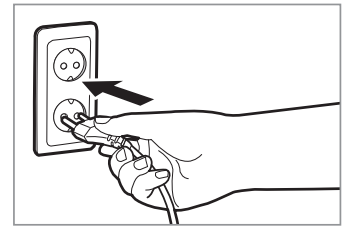

2. Touch the power button to turn the air purifier on.

You will hear a chime sound when the air purifier starts to operate.

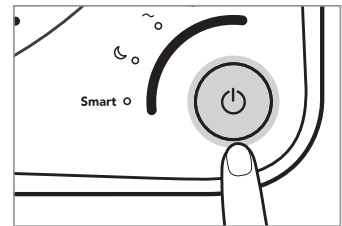



Tips

- Plug the power plug into a socket before operating the purifier.
- When the purifier is turned on, it starts in auto mode by default.

| Smart Mode - Auto

If the product is set to Smart mode, it automatically adjusts the air speed according to the current air quality around the product. Touch the sensor for **Smart**.

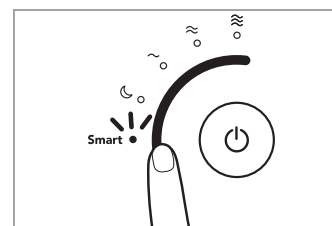

The air speed is adjusted as shown in the table below :

Air Quality	Good	Moderate/unhealthy	Very unhealthy
Air Speed	Level 1	Level 2	Level 3

| Smart Mode - Sleep

If the product is set to Smart mode, Sleep mode is activated automatically so that it can reduce noise and power. It operates when the room is dark and the air quality is Good(Level 1) for 3 minutes.

If the light sensor detects the light for 5 minutes or longer and/or if the air quality level in the room is moderate or worse the Smart mode will not activate automatically.

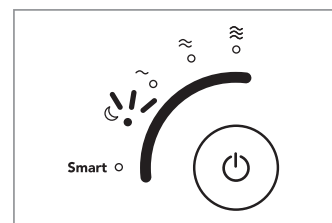

HOW TO USE

| Smart Mode - ECO

If the pollution level remains Good for more than 10 minutes when the product is set to Smart mode, the fan stops automatically to conserve energy. If the product detects air pollution, the fan will automatically restart. If the pollution level remains Good for more than 10 minutes in the smart mode, the fan stops automatically to save energy. If the product detects air pollution, the fan will automatically restart. Also if the ECO mode maintains for 30 minutes, the fan will restart as well. If the pollution level remains Good for more than 10 minutes after restarting, the ECO mode will be activated again.



Fresh Air



Enter ECO Mode

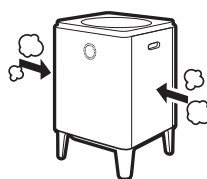

Detecting
Air Pollution



Exit ECO Mode

| Manual Mode

You can adjust the air speed and select Sleep mode manually. Touch the desired air speed or Sleep mode. You can swipe your finger upward or downward to select the air speed or Sleep mode.

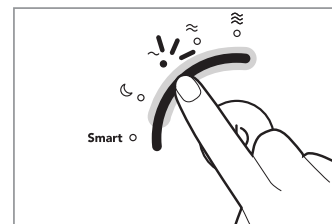

| Setting the Timer

You can set the product to automatically turn off after an hour, 4 hours, or 8 hours. Use this feature to save energy when you leave home or go to bed.

Touch the [Timer] button until the indicator light displays the desired time.

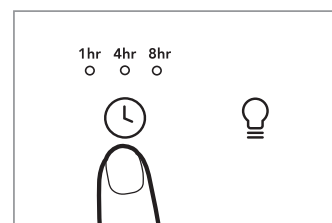

| How to adjust the sensitivity of the pollution sensor

When you first turn on the purifier, the pollution sensor is set to standard. You can adjust the sensitivity as follows if the pollution LED stays at severe even after the purifier runs for 2 hours or more with high pollution or the pollution LED stays at clean even if the pollution is high.

1. Touch and hold the following buttons.

* Mood button + **Smart**

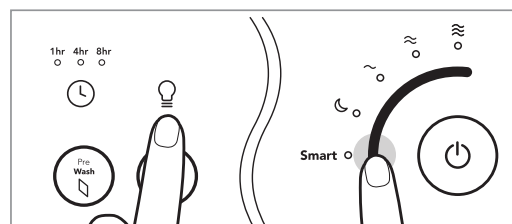

2. Select the sensor sensitivity.

* Touch one of the air speeds to select the desired air sensitivity.

~	≈	≡
Sensitive	Normal	Less sensitive

3. Touch and hold the following buttons.

* Mood button + **Smart**

* You will hear a sound when the setting is saved.

CLEANING METHOD



Tips

- Always unplug the power before cleaning.
- Do not use detergents containing organic solvents (solvents, thinners, etc.), bleach, chlorine, or abrasives to clean.
- Do not immerse the purifier in water or sprinkle water on it.

| Cleaning the outlet and detach-able top outlet grille

Turn the detachable vent grill on top of the outlet counterclockwise and lift it, then clean the grill and outlet with a soft brush or vacuum cleaner.

- * Be careful not to let dust enter the vent while cleaning.

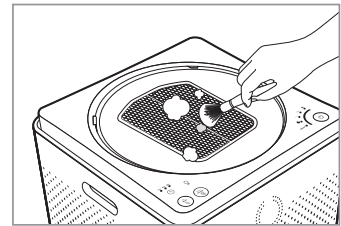
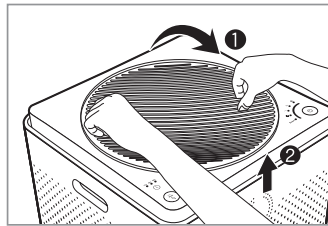

| Cleaning the pollution sensor (clean every 2 months)

1. Clean the pollution sensor air inlet and outlet with a soft brush or vacuum cleaner.

- * Take care that dust does not fall inside the purifier while cleaning.

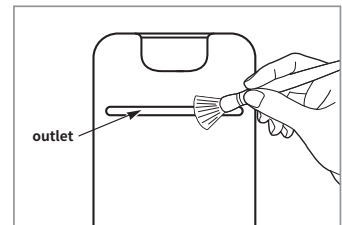

2. Remove the purifier's front cover and open the air pollution sensor cover.

Wet a cotton ball with a small amount of water and wipe the lens, dust intake, and outlet, then wipe again with a dry cotton ball to dry.

- * If cleaning is not done regularly, the performance of the air quality sensor may decrease.
- * If cleaning is not done regularly, the performance of the air quality sensor may decrease.

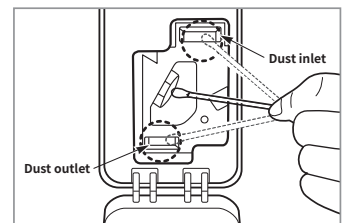
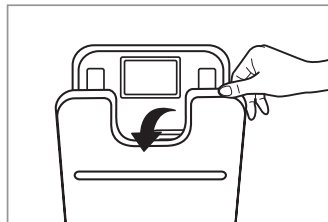

| Cleaning the side cover

Remove the side cover from the purifier and then wipe away dust stuck to the surface with a soft, dry cloth or soft brush.

- * If there is severe contamination, use a damp cloth (do not use abrasives).

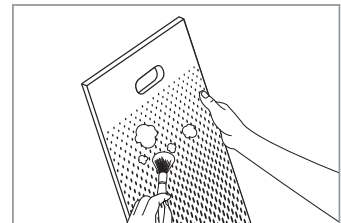

| Cleaning the purifier

Wipe with a soft, dry cloth.

- * If there is severe contamination, use a damp cloth (do not use abrasives).

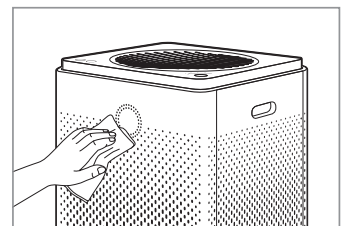



Tips

- Always unplug the power before cleaning the filters.
- The pre-filter can be reused after removing dust and cleaning with water.
- If the pre-filter is not cleaned for a long time, the product performance may decrease and problems may occur.
- The Max2 filters are not reusable. Do not try to clean them with water. Always replace them with a new one.

| Pre-filter(clean every 2 weeks)

When the [Pre Wash] indicator is on, clean your pre-filters on both sides. Follow these instructions below to clean the filters. Filter cleaning cycle can be adjustable in the smart phone application.

1. Pull the upper part of the side cover to open.

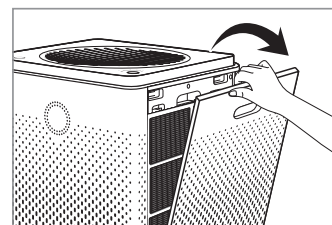

2. Press two tabs at the top of the pre-filters and pull them outward to remove them from the product.

* Be careful that dust doesn't fall out during removal.

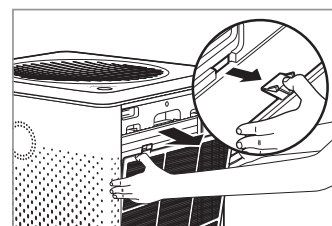

3. Remove dust with water or a vacuum cleaner depending on the degree of contamination.

* If you use water to clean the pre-filter, dry the pre-filter in the shade before re-installing it.

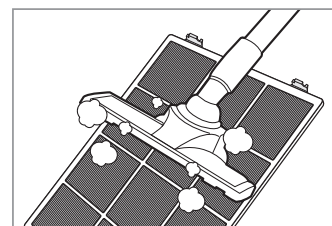

4. Push the completely dry pre-filter all the way into the purifier to install it. Close the side cover again.

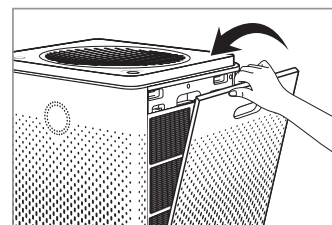
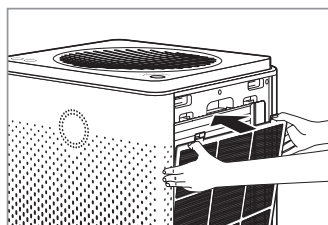

5. Touch and hold the [Pre Wash] button on the control panel to reset the filter indicator.

* After cleaning the pre-filters, you must reset the filter's cleaning cycle using the [Pre Wash] button.

FILTER REPLACEMENT

| How to replace

- Refer to the filter installation method specified on page 20 to replace the filters.
- During filter assembly, be sure to check the front.
- Using a Airmega genuine filter is recommended for optimum performance.
- Always unplug the power plug before replacing filters.

| Filter cleaning and replacement cycle

Maintenance Filter	Maintenance Cycle
Pre-filters*	Cleaning the filters whenever the filter indicator is on**
Max2 filters*	Replacing the filters whenever the filter indicator is on***

* After cleaning or replacing the filters, make sure to reset the filter indicator on the control panel. (P. 18 P. 20)

** Approximately 2 weeks (based on daily 8 hours usage at max speed) Filter cleaning cycle can be adjustable in the smart phone application.

*** Approximately 12 months (based on daily 8 hours usage at max speed) The filter lifetime may differ depending on the real running time of product and the fan speed. The figures above are evaluated on a general basis.

| How to replace the Max2 Filter

When the [Max2 Change] indicator is on, replace your Max2 filters on both sides. Follow these instructions below to replace the filters.

1. Remove the both sides of covers and filters in the following order.

Covers → Pre-filters → Max2 filters

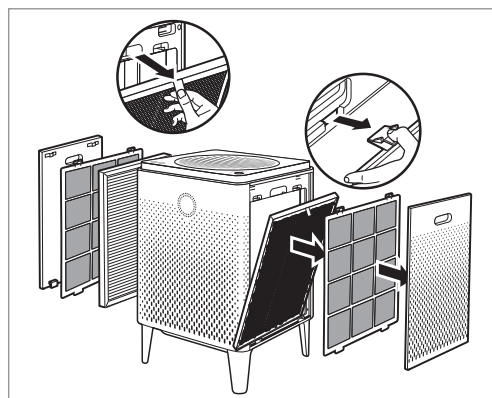

2. Remove the plastic wrapping for the new Max2 filters and discard it.

Discard the old Max2 filters. These are not reusable.

- * After cleaning the pre-filters, you must reset the filter's cleaning cycle using the [Pre Wash] button.
- * Do not allow children to play with the plastic wrapping.

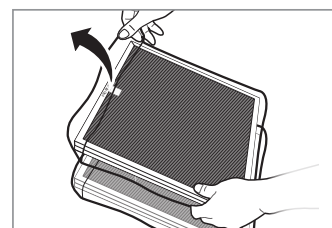

3. Return the both sides of filters and covers in reverse order at the first step.

Max2 filters → Pre-filters → Covers

- * Place the Max2 filters into the filter case with the green side facing the product. Reversed placement may affect the filter lifetime.
- * The product will not turn on if the right and left covers are installed incorrectly.

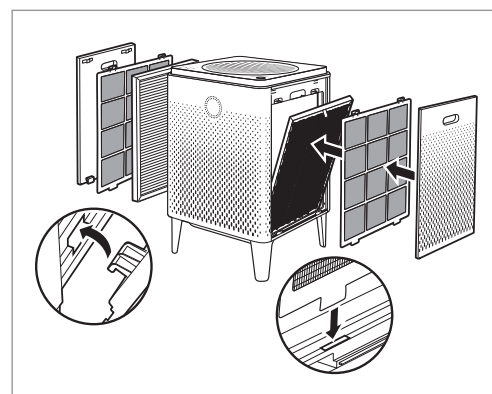

4. Touch and hold the [Max2 Change] button on the control panel to reset the filter indicator.

- * After replacing the Max2 filters, you must reset the filter's replacement cycle using the [Max2 Change] button.

TROUBLESHOOTING

The product may not operate correctly for trivial reasons or due to unfamiliar methods of use that are not product malfunctions. In such cases, the problem can be solved easily without the help of a service center if the following items are checked. If the problem is not resolved even after checking the following, please contact a service center.

Problem	Check	Possible Solutions
There is no breeze.	• Is the power plugged in?	Plug the power cord into a 220 V - 240 V~ 50 Hz, 60 Hz socket.
	• Is the entire display off?	Press the power button, then select your desired function.
	• Is there a power failure?	After the power comes back on, use the purifier.
Fan speed doesn't change.	• Is the automatic indicator off?	You can't select fan speed except in manual mode (normal).
	• Is the sleep indicator off?	You can't select fan speed except in manual mode (normal).
Fan speed is very low.	• Have the filter cleaning and replacement cycle passed?	Confirm the filter cleaning and replacement cycle, and then clean or replace the filter if necessary. (p. 19)
A bad smell comes out from the air outlet.	• Have the filter cleaning and replacement cycle passed?	Confirm the filter cleaning and replacement cycle, and then clean or replace the filter if necessary.
Pollution level doesn't change.	• Is there dust on the air quality sensor lens ?	Clean around the air quality sensor lens (p. 17).
The pollution level indicator flashes.	• Request service.	
If other functional flaws occur	• Check the problem, then unplug the power and request service.	

PRODUCT SPECIFICATIONS

Others

Item	Specification
Model Name	AP-2015F
Filter	Washable Pre - Filter + Max2 filter set (Activated Carbon + GreenHEPA™)
Rated Voltage	220 V - 240 V~ 50 Hz, 60 Hz
Power	66 W
Weight	11.2 kg (24.7 lb)
Size (HWD)	58.0 x 37.6 x 37.6 cm (22.8 x 14.8 x 14.8 inch)

**WARRANTY CARD OR WARRANTY LETTER
TWO YEAR LIMITED WARRANTY
AIR PURIFIER AP-2015F (“PRODUCT”)**

Model:

Serial Number:

Customer Name:

(“OWNER”)

Date of Purchase:

What This Warranty Covers:

Commencing with the date of purchase of the Product and continuing for a period of Two years, if manufacturing defects in the Product cause the Product to not operate properly for its intended use, then subject to the exclusions, conditions, and limitations contained herein, COWAY at its sole option will repair or replace the Product.

Decisions as to the extent of repair or replacement required will be made solely by COWAY.

The remedy under this Warranty is available only for that portion of the Product exhibiting defects at the time of the warranty claim. The replacement Product as well as any remaining original Product will be warranted only for the original two years warranty period. This limited warranty applies only to Product used for an application specified by COWAY for the Product and applied in strict accordance with COWAY published specifications in effect at the time of application. IF PRODUCT IS USED FOR OTHER THAN ITS INTENDED PURPOSE, IT IS SOLD AS IS AND WITHOUT ANY EXPRESS

OR IMPLIED WARRANTIES, INCLUDING OF MERCHANTABILITY OR FITNESS FOR A PARTICULAR PURPOSE.

What This Warranty Does Not Cover:

This Warranty warrants that the Product will be free from manufacturing defects which affect the ability of the Product to operate for its intended use; it is not a warranty that the Product will never require repairs or to undertake responsibilities, liabilities or obligations other than those specifically identified in the preceding section. COWAY is not responsible or liable for personal injury or property damage of any kind, even if arising from a breach of this Warranty.

Limitations and Exclusions:

TO THE EXTENT PERMITTED BY APPLICABLE LAW, COWAY DISCLAIMS ANY OTHER WARRANTY EXPRESS OR IMPLIED, THAN THAT PROVIDED FOR HEREIN. THIS WARRANTY IS IN LIEU OF AND EXCLUDES ALL OTHER WARRANTIES, GUARANTEES, CONDITIONS AND REPRESENTATIONS, EXPRESS OR IMPLIED, ORAL OR WRITTEN, STATUTORY OR OTHERWISE, INCLUDING BUT NOT LIMITED TO ANY IMPLIED CONDITIONS OR WARRANTIES AS TO THE MERCHANTABILITY OR FITNESS FOR A PARTICULAR PURPOSE OF THE COWAY PRODUCT. SOME STATES DO NOT ALLOW LIMITATIONS ON HOW LONG AN IMPLIED WARRANTY LASTS, SO THE ABOVE LIMITATION MAY NOT APPLY TO YOU. COWAY DOES NOT AUTHORIZE ANY PERSON INCLUDING ITS REPRESENTATIVES, TO MAKE ANY REPRESENTATION OR TO OFFER ANY WARRANTY, CONDITION OR GUARANTY IN RESPECT OF THE PRODUCT OTHER THAN THIS WARRANTY. THIS LIMITED WARRANTY SHALL BE THE OWNER’S SOLE AND EXCLUSIVE REMEDY AGAINST COWAY AND COWAY SHALL NOT BE LIABLE FOR ANY CONSEQUENTIAL, EXEMPLARY, SPECIAL, INCIDENTAL OR OTHER DAMAGES INCLUDING, BUT NOT LIMITED TO, LOSS OF PROFITS, AND LOSS OF USE. INCIDENTAL, CONSEQUENTIAL AND EXEMPLARY DAMAGES SHALL NOT BE RECOVERABLE EVEN IF THE REMEDIES OR THE ACTIONS PROVIDED FOR IN THIS WARRANTY FAIL OF THEIR ESSENTIAL PURPOSE. SOME STATES DO NOT ALLOW THE EXCLUSION OR LIMITATION OF INCIDENTAL OR CONSEQUENTIAL DAMAGES, SO THE ABOVE LIMITATION OR EXCLUSION MAY NOT APPLY TO YOU. COWAY SHALL NOT BE LIABLE FOR ANY DAMAGES WHICH ARE BASED UPON NEGLIGENCE, BREACH OF WARRANTY, STRICT LIABILITY OR ANY OTHER LEGAL THEORY OF LIABILITY OTHER THAN THE EXCLUSIVE LIABILITY SET FORTH IN THIS WARRANTY.

Limitations on Implied Warranties:

Any implied warranty of merchantability or fitness for a particular purpose or use, shall be limited to the duration of the foregoing express written warranty.

Conditions of Warranty:

COWAY's continuing liability under this Warranty is conditioned upon the following:

- a) The defect or damage is not caused by or is the result of: abnormal use or conditions; improper storage, unauthorized modifications or repair; misuse, neglect, accident, alteration, improper installation or other acts that are not the fault of Coway or the manufacturer of the product or that are not covered by the manufacturer's warranty;
- b) The Product has not been altered, modified or repaired without prior written approval of COWAY;
- c) The OWNER has notified COWAY in writing of any failure of the Product covered by this Warranty within thirty (30) days following such failure;
- d) There has been no misuse, abuse or negligence with respect to the Product on the part of the OWNER.

Waiver:

COWAY's failure at any time to enforce or rely upon any of the terms or conditions stated herein shall not be construed to be a waiver of its rights hereunder.

Obtaining Warranty Service and OWNER'S Duties:

If the Product fails to operate for its intended purpose, then notify COWAY or its Representative Agency, within 48 hours or within the next business day after discovery of any defect in the Product. The OWNER must give written notice to COWAY no later than thirty (30) days after a defect is discovered or should by reasonable diligence have been discovered. Claims under this Warranty will require proof of purchase by the OWNER

COWAY
Add : COWAY Co., Ltd. 136-23, Yugumagoksa-ro, Yugu-eup, Gongju-si, Chungcheongnam-do, Korea Tel. : Korea-Seoul : +82-1588-5100

COWAY EU
Tel. : UK - London : +44 2032807197 GERMANY - Hamburg : +49 4087406758 FRANCE - Paris : +33 170120004 ITALY - Milan : +39 0236003045 SPAIN - Madrid : +34 911234181 Mail : info_eu@coway.com Web : de.coway.com

POLAND
Add : OPUS SP. z o.o. Toruńska 8, 44-122 Gliwice Tel. : +32 4201255 Mail : serwis@opus.pl

SWEDEN
Add : Albion Nordic AB Traktorgatan 2 745 37 Enköping Sweden Tel. : +46 171 66 33 00 Mail : info@albionnordic.com Web : www.albionnordic.com