



INSTALLATION INSTRUCTIONS

Swing Extreme

Need a hand? Give us a call. 888.525.1185

Also, feedback is appreciated. If you think any part of this manual is confusing, or if you have suggestions for how to better explain one of the steps, please let us know by emailing info@theswingsetco.com

The Swingset Company (TSC) team has designed the easiest playset to assemble (in our humble opinion :) We've pre-drilled all the holes, sanded all the wood, and pre-assembled many of the parts for you. We even use the fewest variations of fasteners. We hope you find this assembly to be enjoyable and stress-free. But if you get stuck, don't hesitate to call us at 888.525.1185. Please let us know your thoughts when you're done. Happy Building!

Tools Needed:



Power or Hammer Drill



Bubble Level



90° Angle



1/2" & 11/16" Sockets & Wrench



#2 Phillips Head Screw Driver



6' Ladder

IMPORTANT: These Instructions were written assuming you have firm, level ground or you have ensured the ground is the same elevation at the points where the posts and A-Frame legs touch the ground. **See the "Layout Diagram" at the end of this manual for reference.** If your ground is not the same elevation at all the ground contact points, it will still be possible to assemble this swing set, however you will need to ensure stability of the swing set (e.g. by attaching 4x4 post extensions where the posts or A-Frame legs may not be long enough to reach the ground.) TSC does not take any responsibility for an assembly where the ground is not fully level and the elevations at the ground contact points are not the same.

Safety Instructions

1. This playset is intended for use in residential settings by children ages 3-11 years of age. Use in public settings will void the warranty and can cause unexpected component failure leading to injury or death.
2. The maximum safe weight on the Fort deck is 500 lb. Maximum weight for the Fort Extension Board is 200 lb. Maximum weight for the Swing Beam is 400lbs for the 2-swing models; 600lbs for the 3-swing models (or 200lbs per swing).
3. As your swing set acclimates to its new environment, natural characteristics of the wood can show in the form of checks, or "cracks" in the lumber. In almost all cases this is normal and it will not affect the structural integrity of your play set and is not covered under warranty.
4. As with any home project, good judgment and respect for power tools will greatly reduce the risk of injury. Follow all tool manufacturers' safety guidelines. Always wear eye protection and safety gloves to prevent injury.
5. While the play set is being constructed, please keep children off the equipment until the project is complete.
6. The Swingset Company (TSC) shall not be liable for incidental, indirect or consequential damages or injuries that result from building and/or playing on our play sets. Adult supervision is recommended anytime a play set is being used.
7. TSC recommends that the weight limits for all components must not be exceeded. Failure to adhere to these and other safety guidelines could result in damage to the play set and injury to the users.
8. Your children's safety is our #1 concern. Observing the cautions in this manual and those of the associated options reduces the likelihood of serious or fatal injury. Please review these safety rules regularly with your children.

SECTION 1

The Fort Frame



Before you start, find the box labeled “Fort Accessories”. This is where you’ll find all your screws and the special drill bit required for assembly.

We’ve provided a few extra screws in each bag, just in case you lose a few 😊

Step 1: Create Two A-Frames

Lay the four Posts (#1) on the ground as shown. Using the four Crossbeams (#2), construct two A-Frames as shown to the right. Place the Crossbeams (#2) between the lines as shown in figures A & B. Make sure the Crossbeams are completely square & perpendicular to the Posts. Attach using two "A" Screws at each end of the Crossbeam. Use the provided drill bit (T-25) to attach all the screws in this manual.

[Tip: use a 90 degree angle to ensure the beams are square & perpendicular]

Parts Needed:





	x4
	x4
	x16
	x1

Figure B



Make sure all beams are flush to the edges of the posts, as shown.

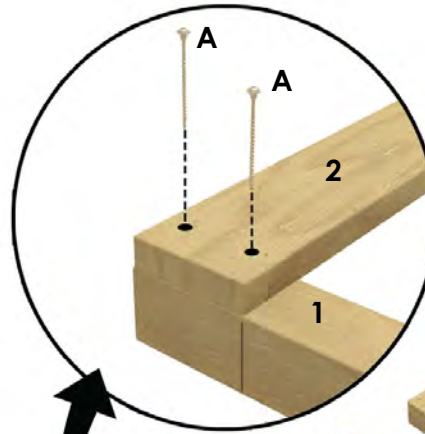
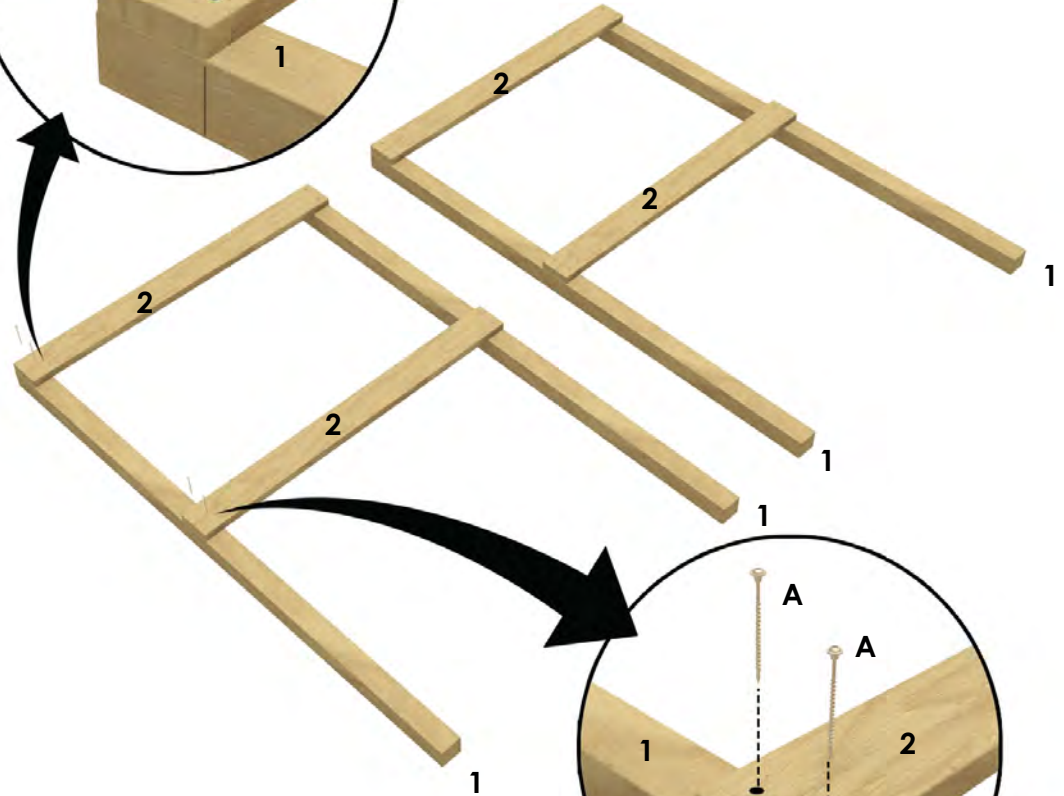
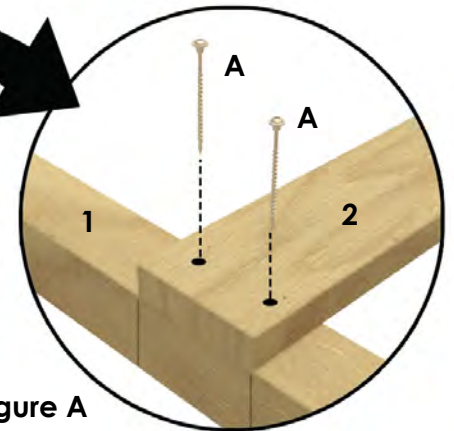

Figure A



Step 2: Attach 2 Floor Beams

Turn one of the A-Frames over so the Crossbeam side rests on the ground. Attach the Floor Beams (#3) to the Posts (#1) using two "A" screws in each side, see Figure C. Make sure the Floor Beams (#3) are aligned between the lines of the posts, and the bottom edges are flush to the bottom edges of the posts, as in the prior step.

Parts Needed:

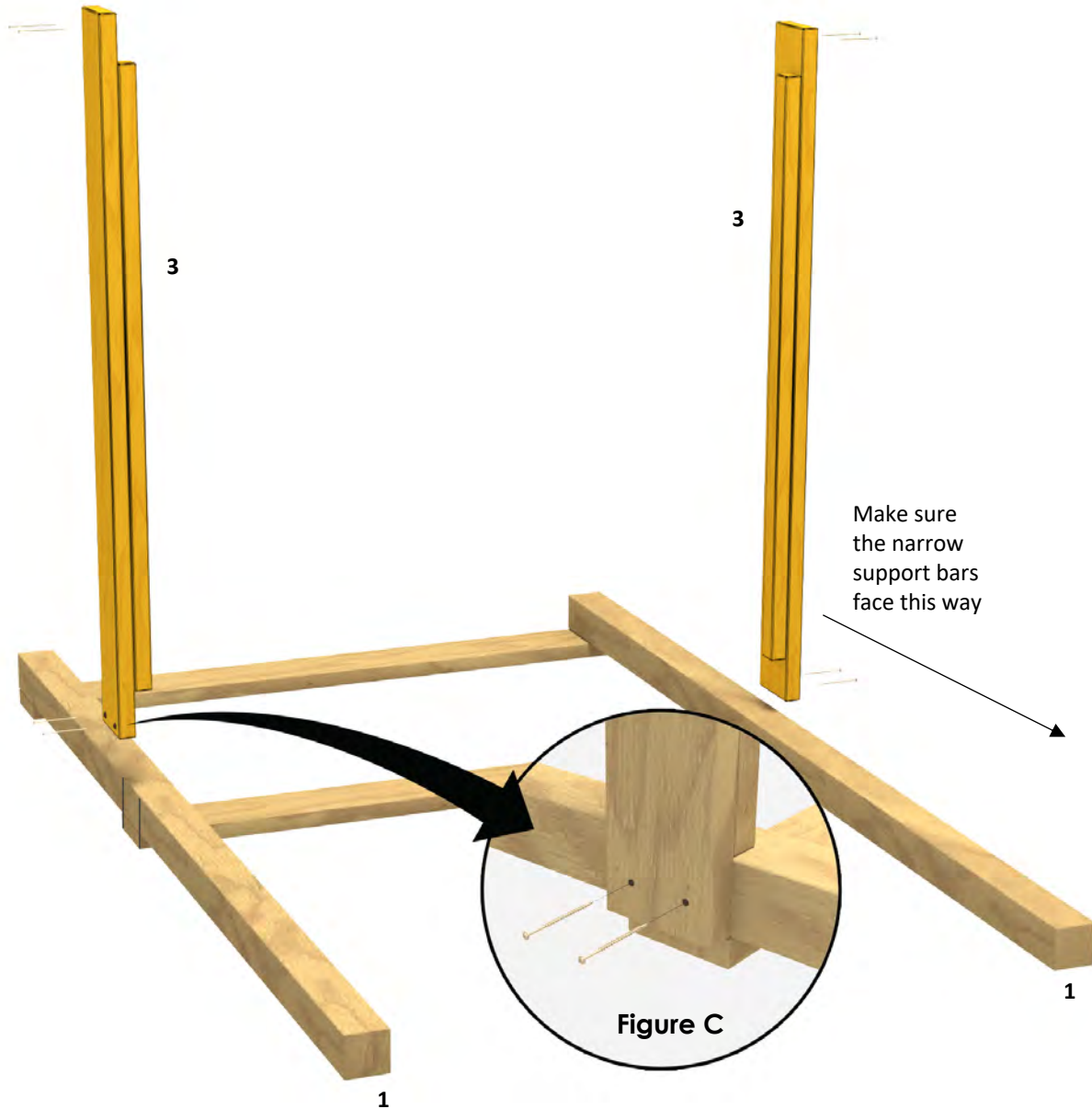
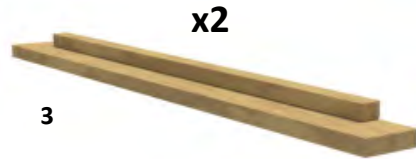

Step 3: Connect Both A-Frames

You'll need your friend for this next part. Stand up the A-Frame with the attached Floor Beams, and place it opposite the other "A" Frame.

Align the Floor Beams with the lines on the posts of the other A-Frame. Use a bubble level to make sure all beams are horizontal and level. Secure using two "A" screws on each side, see Figure D.

IMPORTANT: The ground beneath each post must be at the same level to ensure all beams are horizontal and square.

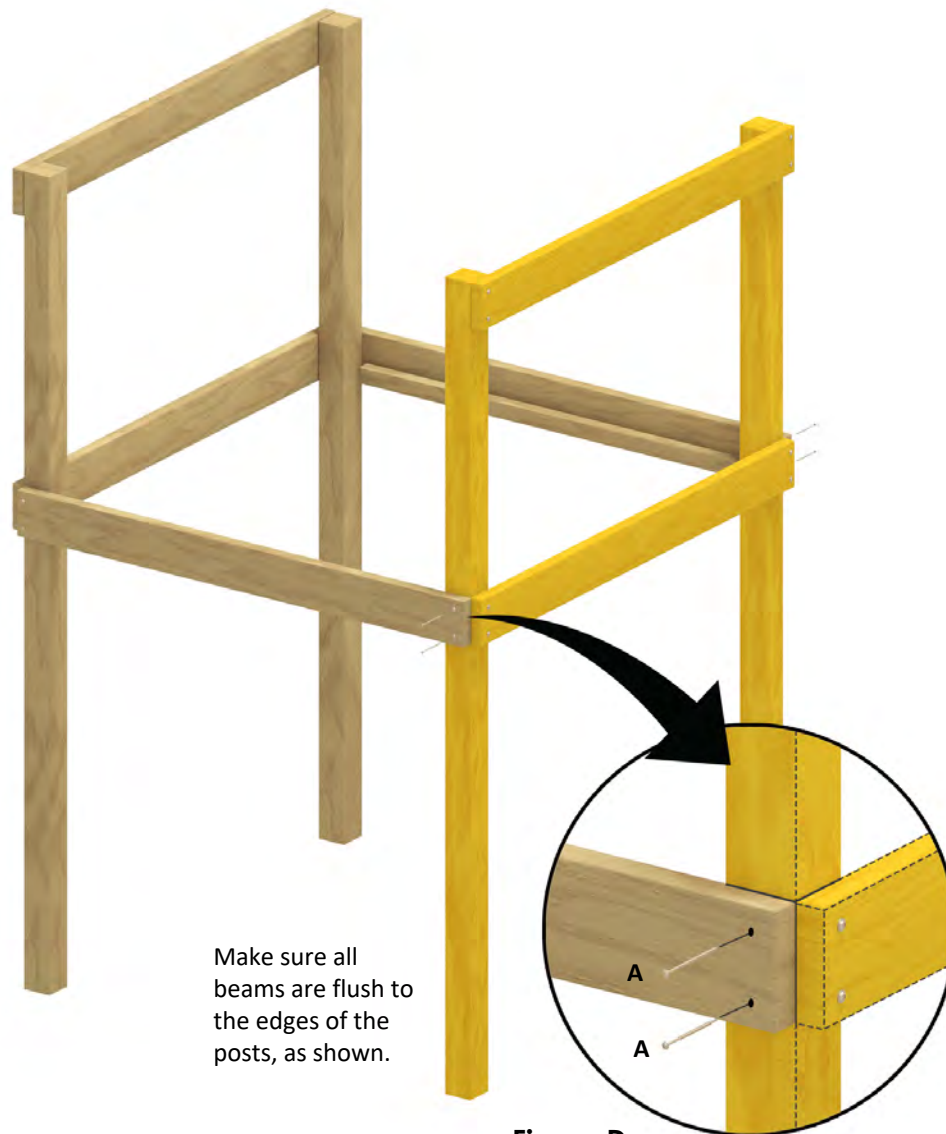



Figure D

Parts Needed:

A  x4

Step 4: Attach Braces

Find the box that says “Braces”. Attach the 8 Braces between the Posts (#1) and the Crossbeams (#2 & 3). Use two “A” Screws for each brace, as shown in Figure E.

Tip: Make sure the end of each Brace lines up with the edge of each Post and the bottom of the beam, see figure F.



Figure F

Parts Needed:



x8

A



x16

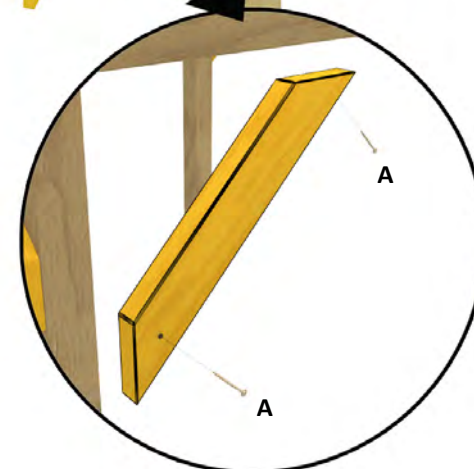

Figure E

Step 5: Install Deck Floors

You'll need your friend again for this step. Insert the two Deck Floors. They are identical. The cutout in the floor joists should rest on the support bars of the Crossbeams. Do NOT screw them into place yet.



Step 6: Attach Ladder, Slide & Top Cross Beams

Note: The ladder and Slide can be placed on any side you wish.

Attach the Ladder using the instruction sheet and hardware provided with the Ladder.

Next, attach the Slide using three “B” screws. The screws should drill through the slide’s holes and into the bottom Crossbeam, see Figure G.

Important: Make sure the Ladder is placed all the way to one side of the deck floor, and the Slide all the way to the opposite side. The two holes in the deck floor need to be between the Ladder and Slide.

Finally, attach the last two Crossbeams (#2) using two “A” screws in each side, See Figure H.

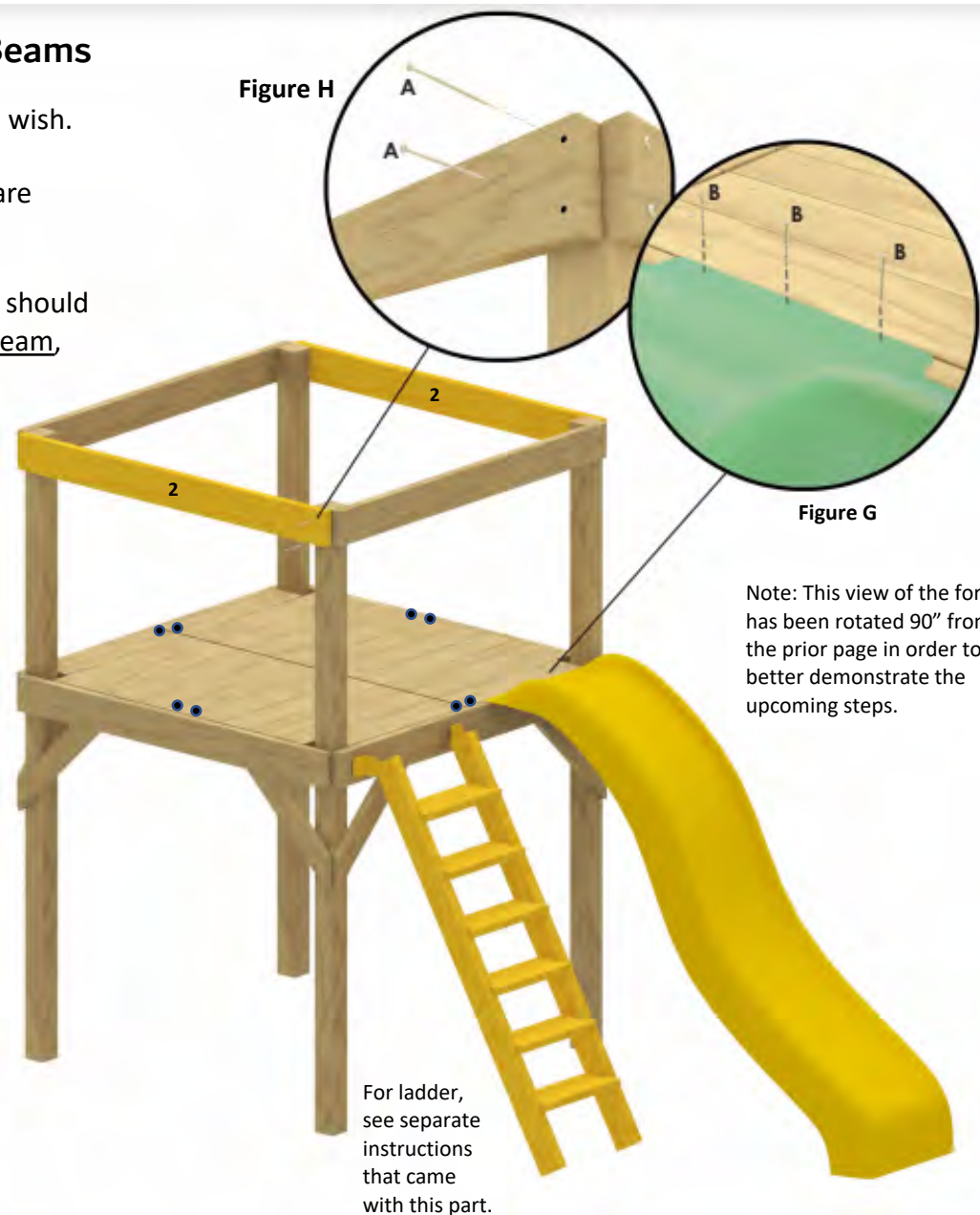
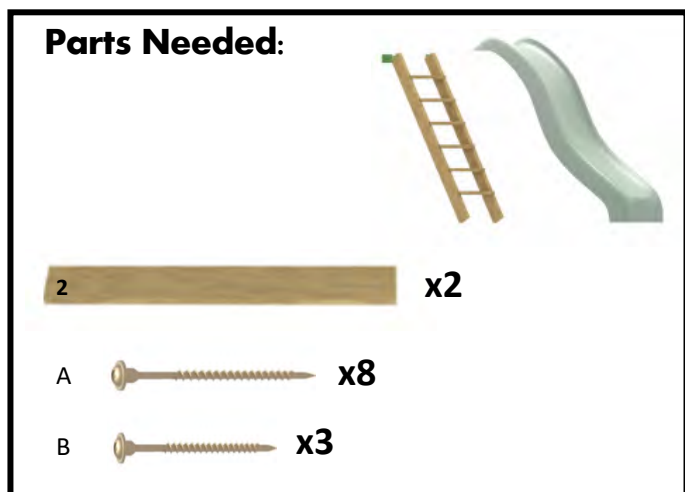

Step 7: Attach Vertical Boards & Crossbar

Find the package “VERTICALS” containing the 4 parts below with the plastic stubs (2 tall & 2 short) and insert them into the holes on the deck floor (see picture to right). If need be, adjust the deck floors to fit the vertical stubs.

IMPORTANT: Install the “Tall verticals” opposite each other, then do the same for the “Small Verticals”. Tall vertical should be placed between the slide and ladder.

Make sure all verticals are truly vertical (use a bubble level to help check this), and attach to the upper Crossbeams (#2) using two “C” screws, see figure 1.

Next, install the crossbar (#4) to the top of the Tall Verticals using two “C” screws, one on each end, as shown to the right.

Finally, install the 2 green safety handles which came with the ladder. One handle will attach to the Post, the other to the Tall Vertical.

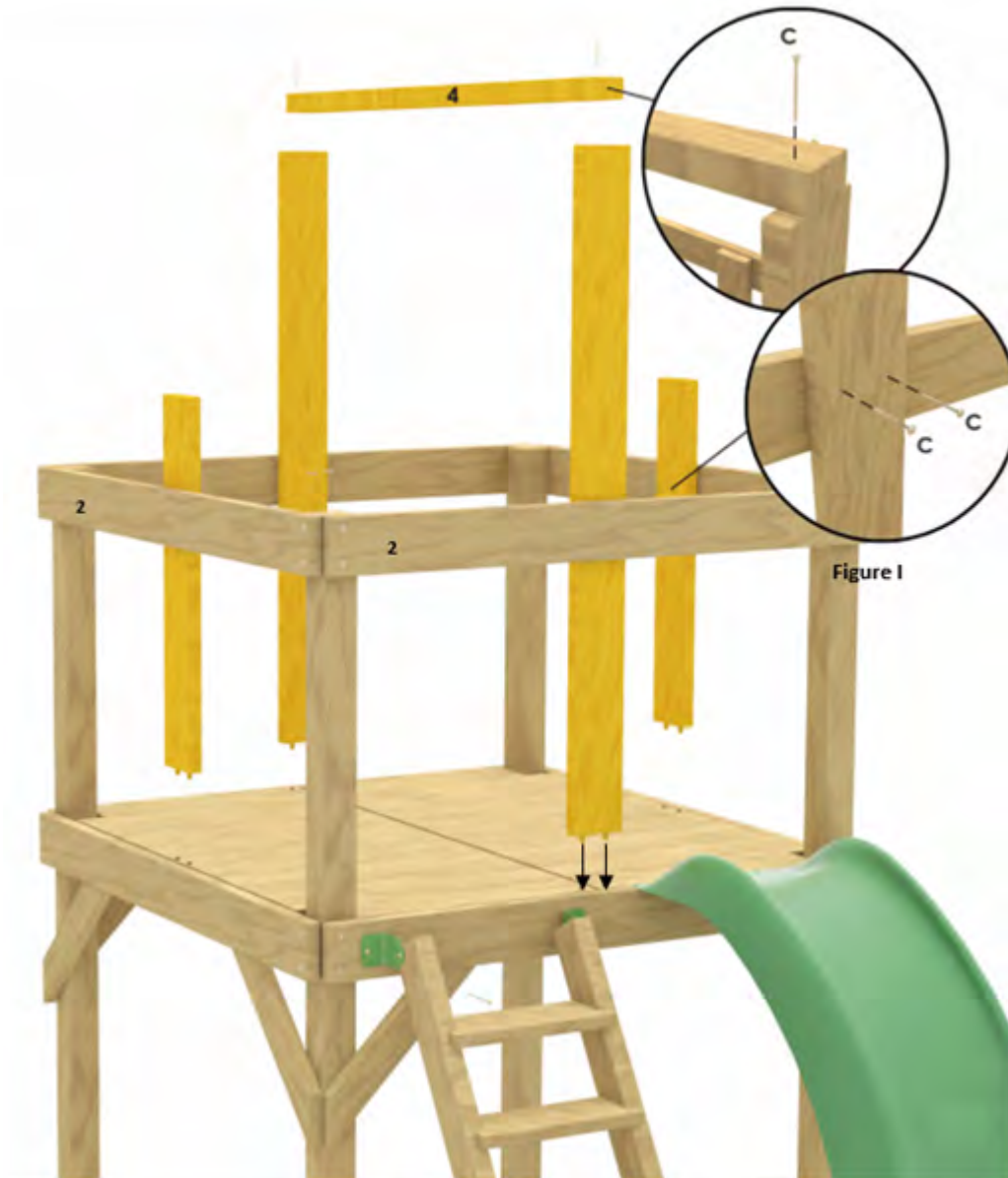

Parts Needed:

4 x1



C x10

Step 8: Screw the Deck Floors in Place

Now you can secure the deck floor using the 8 pocket holes under the deck floor. Use the "C" screws, as shown.

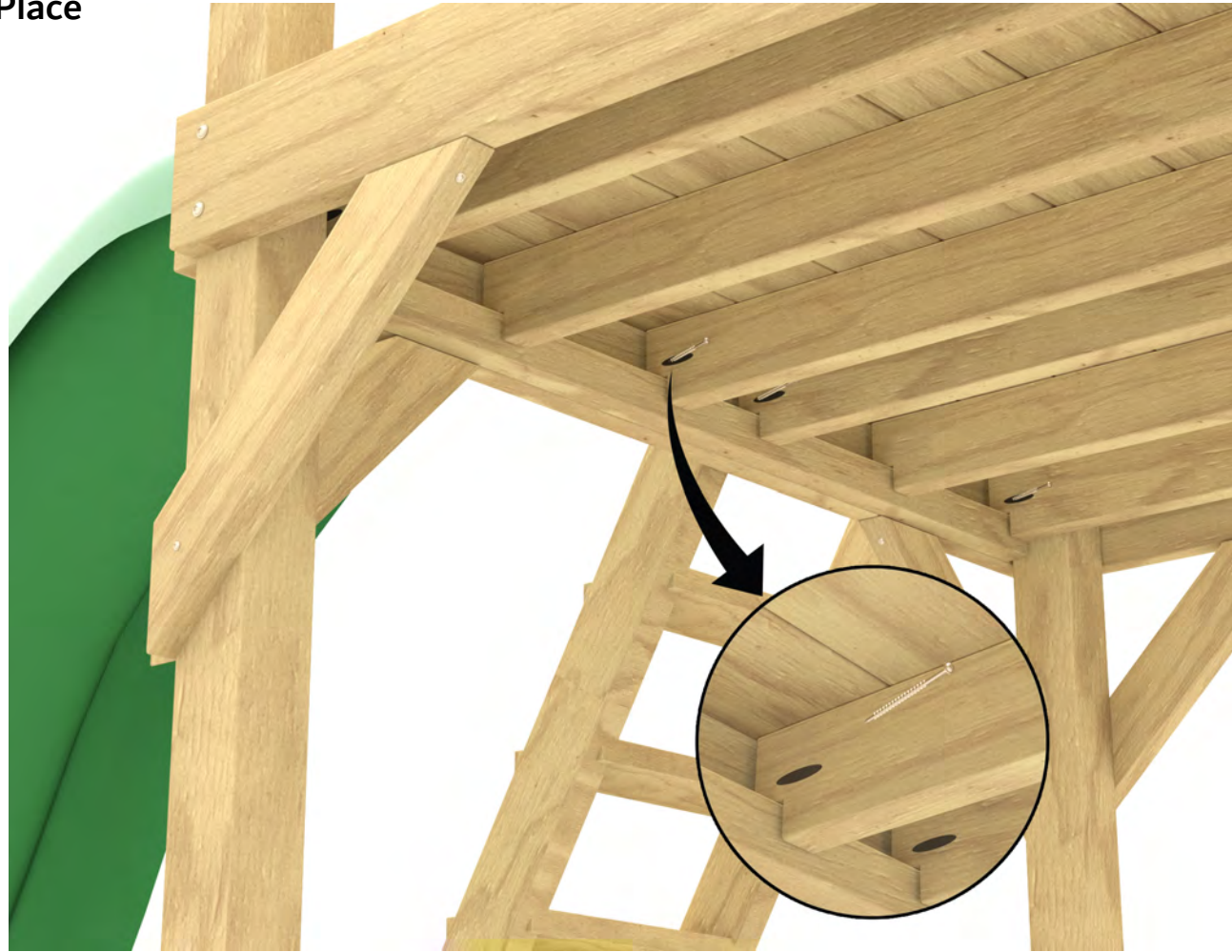

Parts Needed:

c  x8



GREAT JOB!

The Fort should look like this.

SECTION 2:

“Swing Extreme” SWINGSET

Walls, Extension Beams &
Other Attachments

Step 9: Attach Climbing Wall

Attach Rock Climbing Wall. See separate instructions provided with rock climbing wall packaging. The Climbing Wall goes directly behind the ladder on the opposite side of the deck.

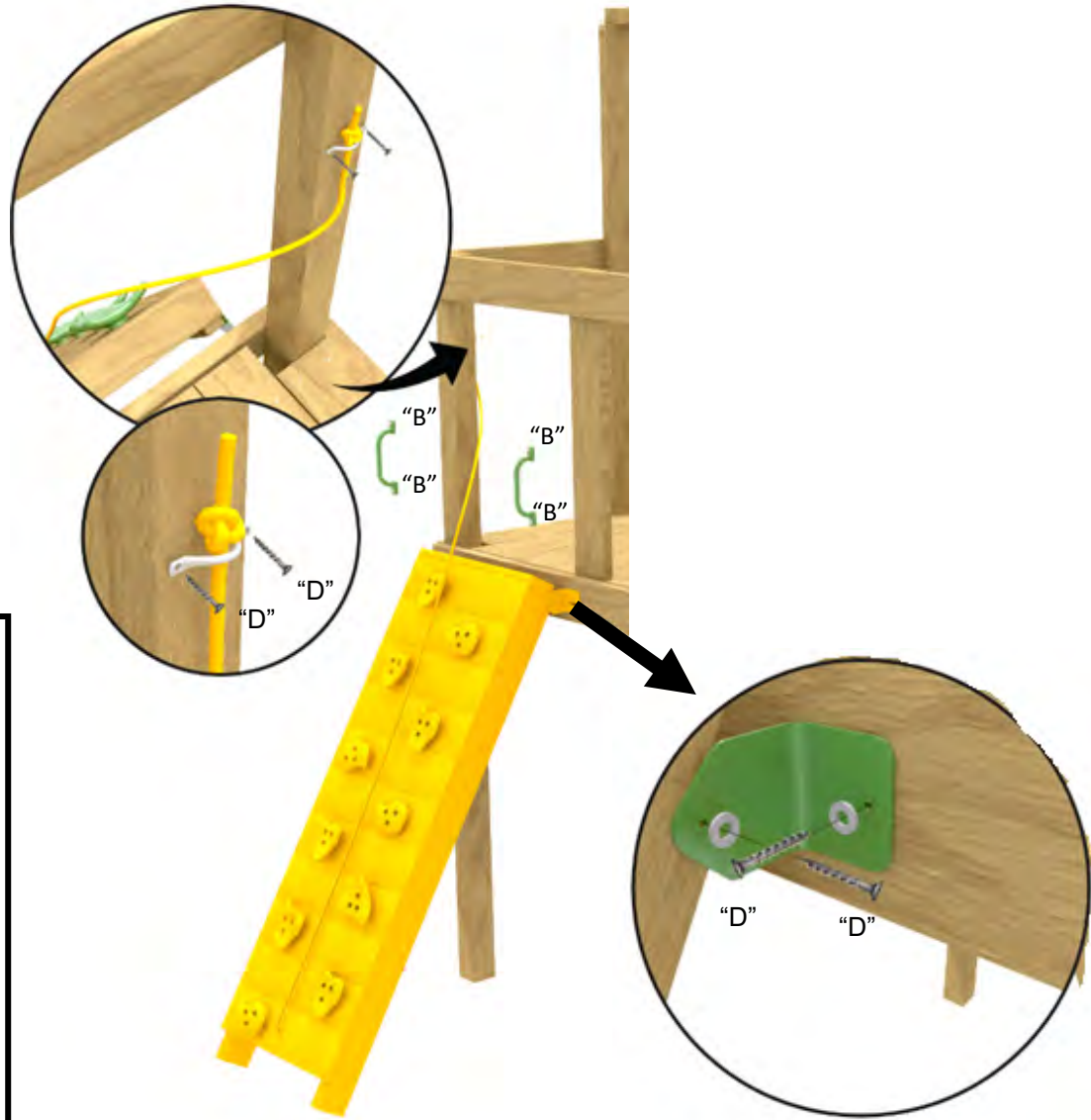

Parts Needed:

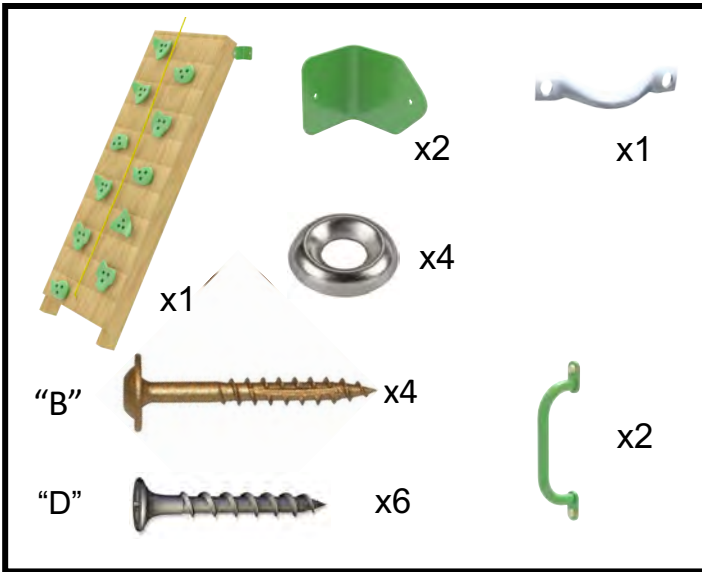

Step 10: Attach Walls

Find the 5 walls and attach them as shown. Make sure to align the ends of each wall with the outside edges of the posts. Use one "C" Screw in each wall corner, See Figure K.

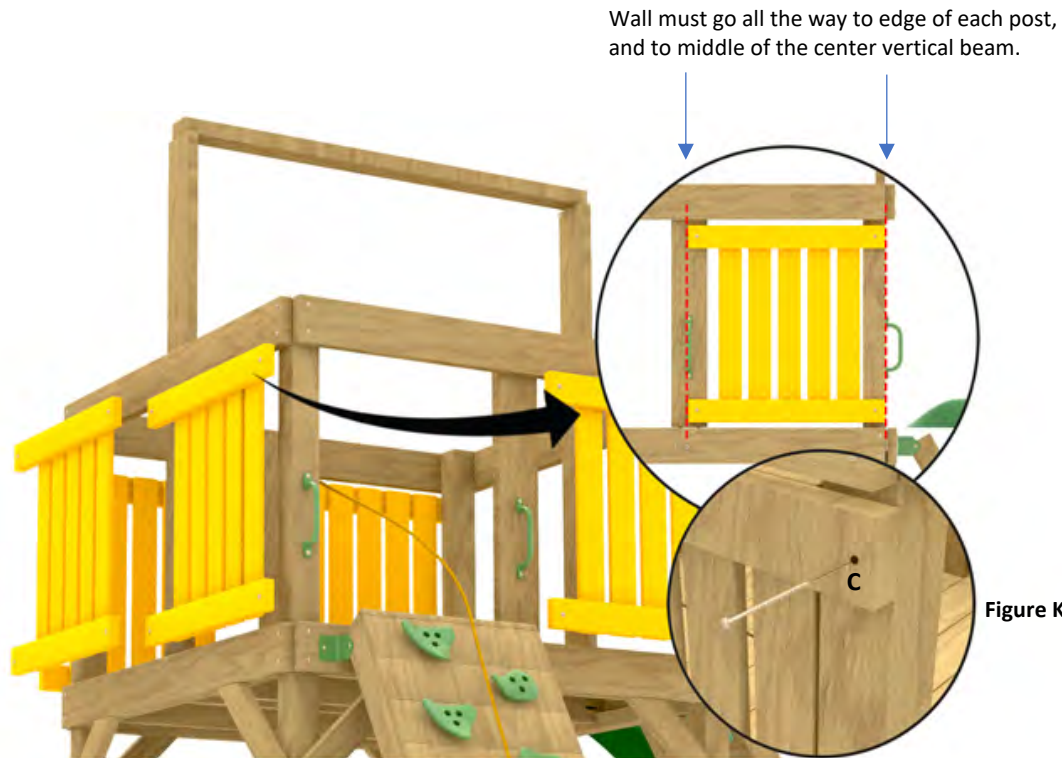

Parts Needed:



x5



x20

Step 11: Picnic Table

The picnic table will go underneath the deck floor. Use the instruction sheet that came packaged with the Picnic Table for assembly.

IMPORTANT: Make sure to place the picnic table on the same side of the fort that the swing beam will be connected to. The Picnic table will also serve to block off direct access to the swinging area.



Step 12: Chalkboard

Attach the chalkboard to the inside of 2 posts. Use the Instruction Sheet that came attached to the Chalkboard.



SECTION 3

The Swing Beam & A-Frame

**YOU WILL DO SECTION 3 TWO TIMES.
ONE TIME FOR EACH SIDE OF THE FORT.**



Step 1: Attach Fort Bracket

Find the box labeled "Swing Beam Mounting Parts". Then find the Fort Bracket. **All the screws and fasteners required for this section are found in the "Swing Beam Mounting Parts" box.**

Place the Fort Bracket over the upper Crossbeam and between the Posts and Verticals, as shown. Push bracket down over the upper crossbeam so it fits snugly into place. Secure the bracket using 3 "B" screws, as shown in Figure P .

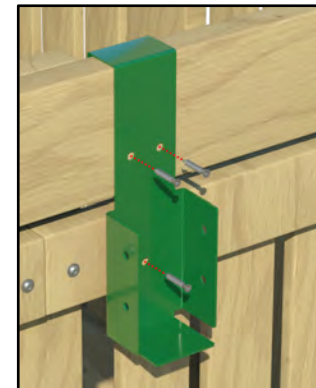
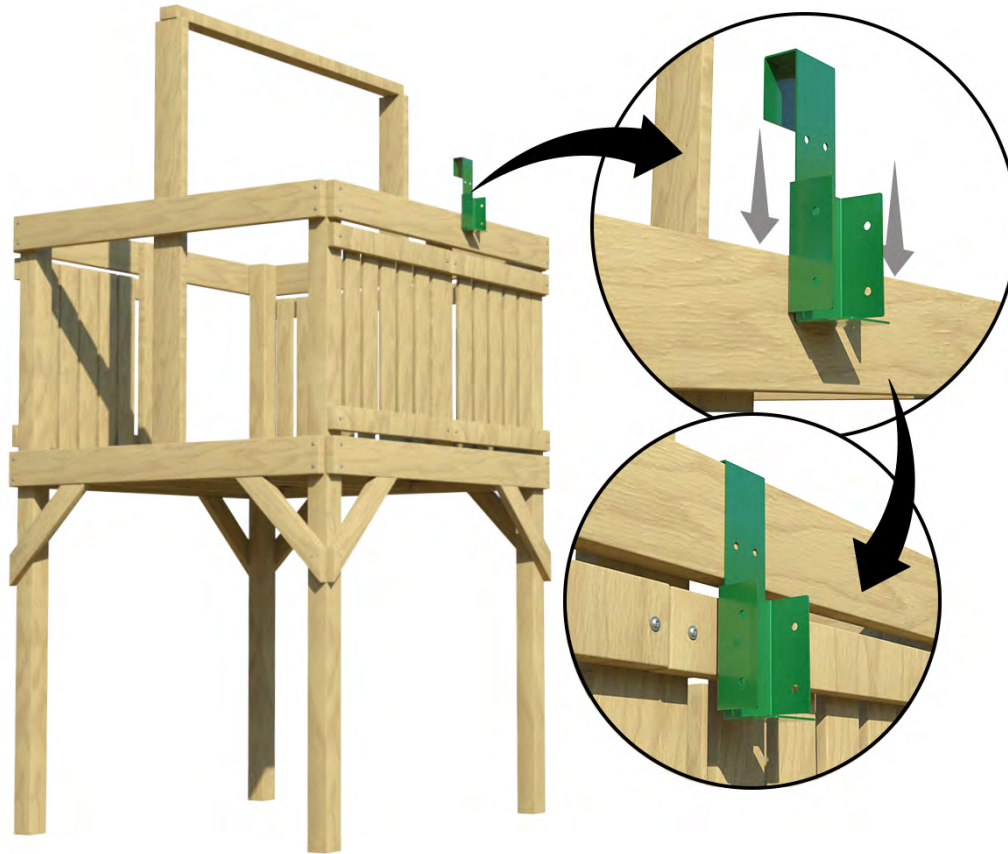
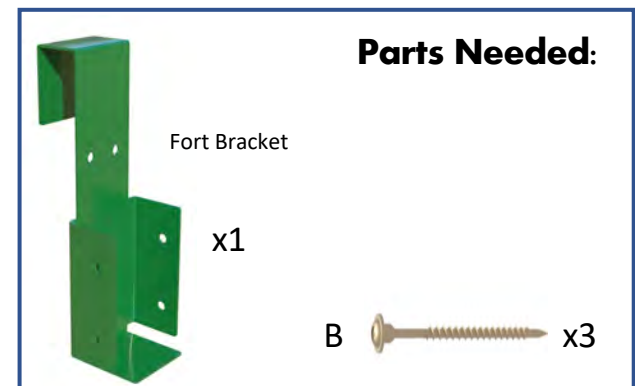
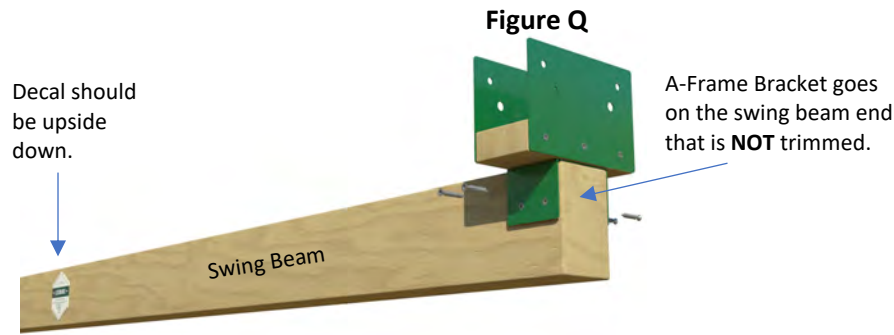

Figure P



Step 2:



Step 2 & 3: Attach A-Frame Bracket to Swing Beam

Locate the Swing Beam and A-Frame Bracket. **IMPORTANT: Turn the Swing Beam upside down so the Swingset Company decal is upside down. The Swing Beam has one side that is trimmed and one side that is not. The A-Frame Bracket goes on the end of the Swing Beam that is NOT trimmed.**

Place the A-Frame Bracket on the untrimmed end of the Swing Beam. Make sure the A-Frame Bracket is flush to the end of the Swing Beam (Figure Q). Secure the A-Frame Bracket to the Swing Beam using 2 "B" screws on each side, as shown in Figure Q.

Next, flip the Swing Beam right side up. Install Swing Hangers, as shown in Figure R. Make sure lock nuts are tight.

Step 3:

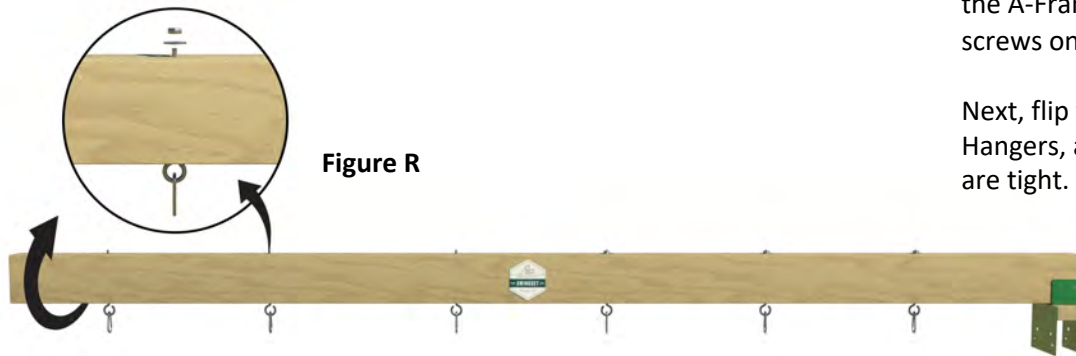

x6 (x4 for 2-seat Swing Beam)

A-Frame Bracket

x1



x4

Parts Needed:



x1

Step 4: Attach A-Frame Legs to Swing Beam

Find the 2 legs (#7) of the A-Frame. Slide them into the A-Frame Bracket as shown. Install the 4-1/2" bolts, nuts & washers as shown, but don't fully tighten until later.

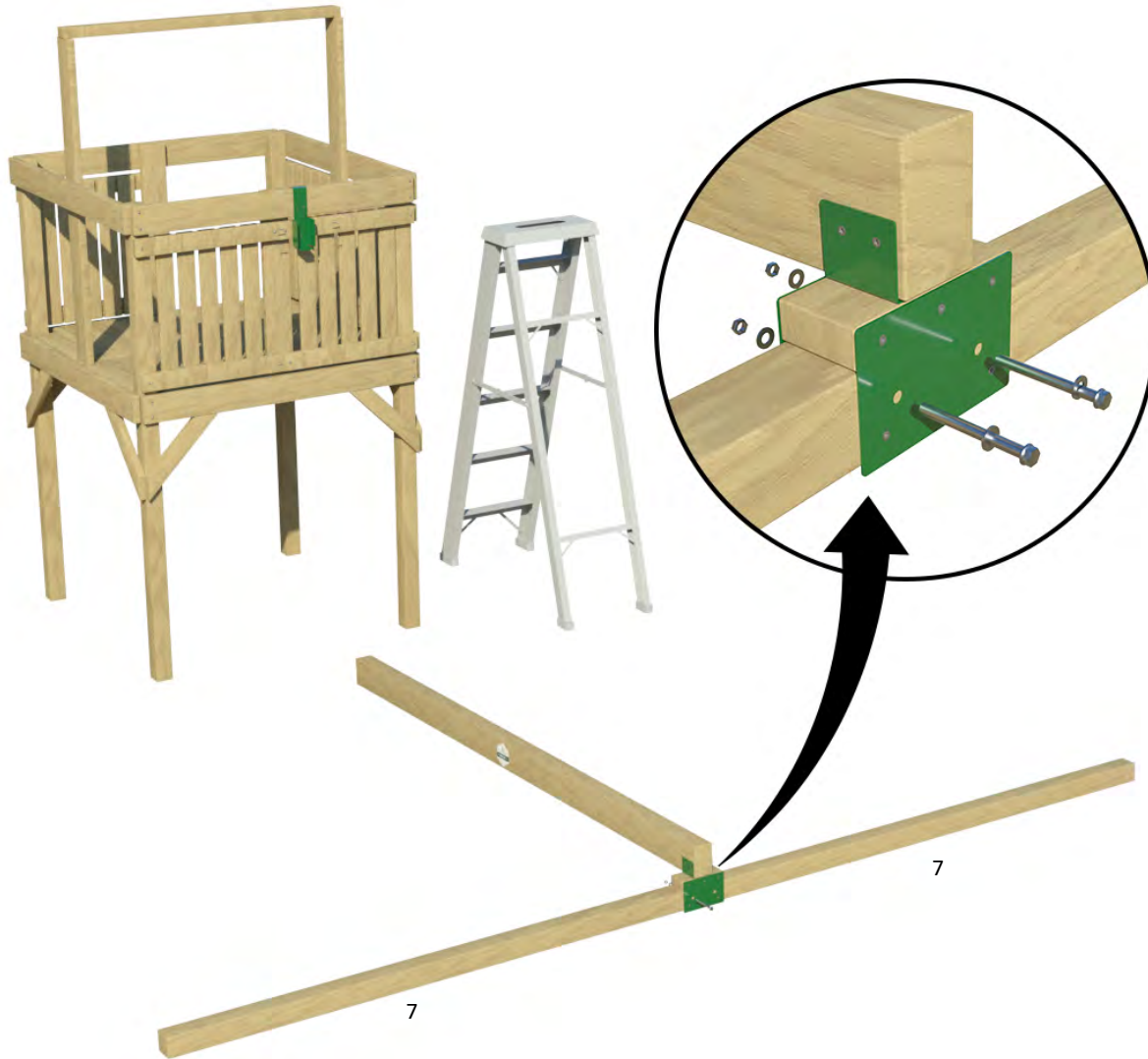

Parts Needed:



Step 5: Lift Swing Beam onto Fort Bracket

You'll need your friend for this (a 6ft ladder may also be helpful). Drag the Swing Beam and A-Frame legs over to the fort so the **trimmed** end of the Swing Beam lies underneath the Fort Support. Once in position, lift the Swing Beam and insert the Swing Beam into the Fort Bracket, as shown in Figure U. The A-Frame legs will automatically rise and set into place.

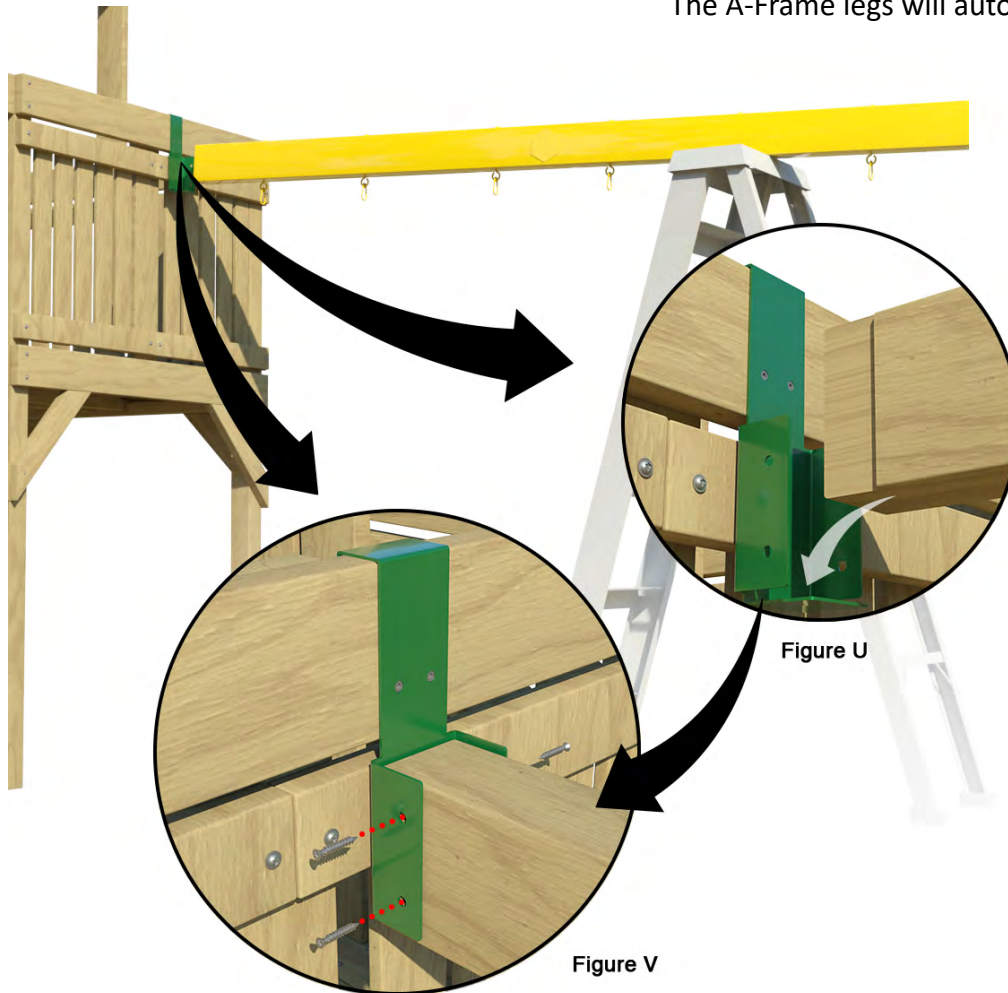

Make sure the trimmed end of the Swing Beam fits snugly into the Fort Bracket and touches the back end of the bracket, as shown in Figure V.

Finally, make sure the Swing Beam is perfectly horizontal, using a bubble level to test it. You may need to adjust the A-Frame legs to achieve a perfectly level Swing Beam. Once the Swing Beam is in place and level, install 2 "B" screws in each side of the Fort Bracket, as shown in Figure V.

Parts Needed:

B  x4

Step 6: Attach the Cross Bar & Tighten the A-Frame Bracket

Important: Make sure the Swing Beam is level, AND make sure the A-Frame Legs are at least 7' apart (see Figure W).

Attach Board (#4) to the two Legs of the A-Frame using 2 "A" Screws, one in each side of the board (see Figure X). Use a bubble level to ensure this Board is level.

Next, on the A-Frame Bracket, install 2 "B" Screws below the Bolts on both sides of the Support Bracket. Finally, fully tighten the Bolts in the A-Frame Bracket.

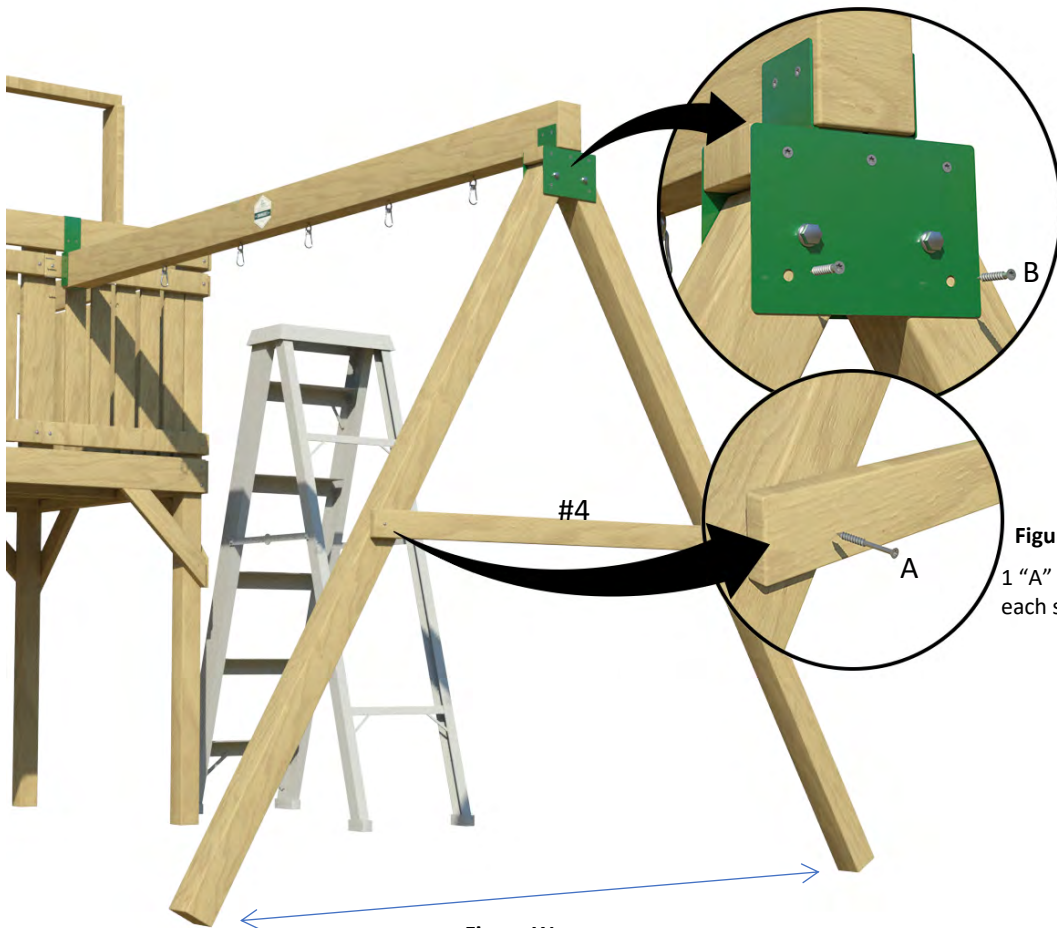





Figure X

1 "A" Screw on each side of beam

Figure W

Legs must be AT LEAST 7ft apart. No Less.

Parts Needed:

#4		x1
A		x2
B		x4

The first completed side of the swing beam & A-frame assembly.

NOW YOU GET TO DO IT AGAIN FOR THE OPPOSITE SIDE. REPEAT SECTION 3, THIS TIME ON THE OTHER SIDE OF THE FORT.







Step 7: Install Tarp Roof

Spread Tarp evenly over top bar as shown.

While a helper holds the opposite side in one corner, pull the tarp tight. Adjust as needed to keep the sides even.

Secure to upper beams with one "B" screw per grommet hole. Repeat until all grommets are secured.

Parts Needed:

	x1
B 	x8

Step 8: Ship Wheel, Telescope & Flag.

Finally, it's time to install the ship wheel, telescope and flag.

Insert flag into existing hole, which has been predrilled.

For the telescope, use the provided yellow "L" brackets to hold down the telescope base onto the crossbeam.

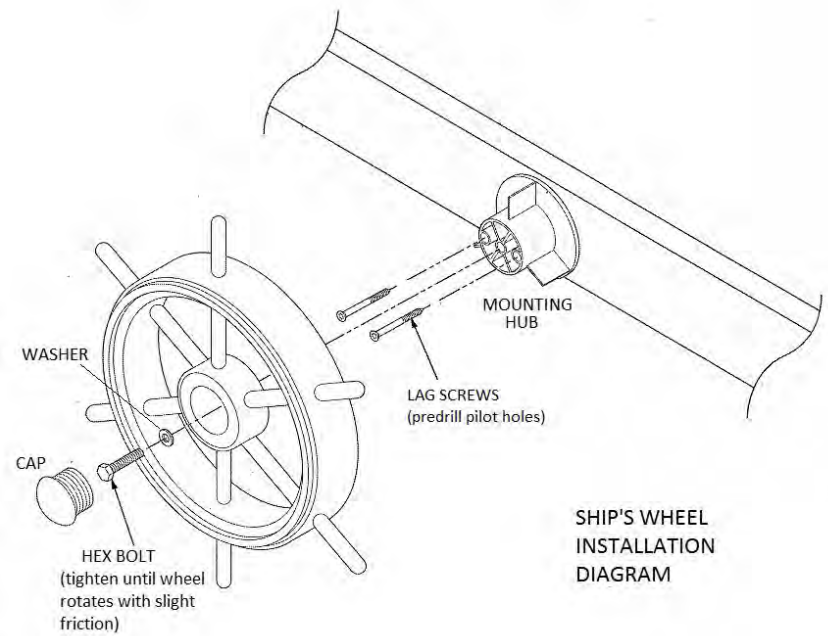
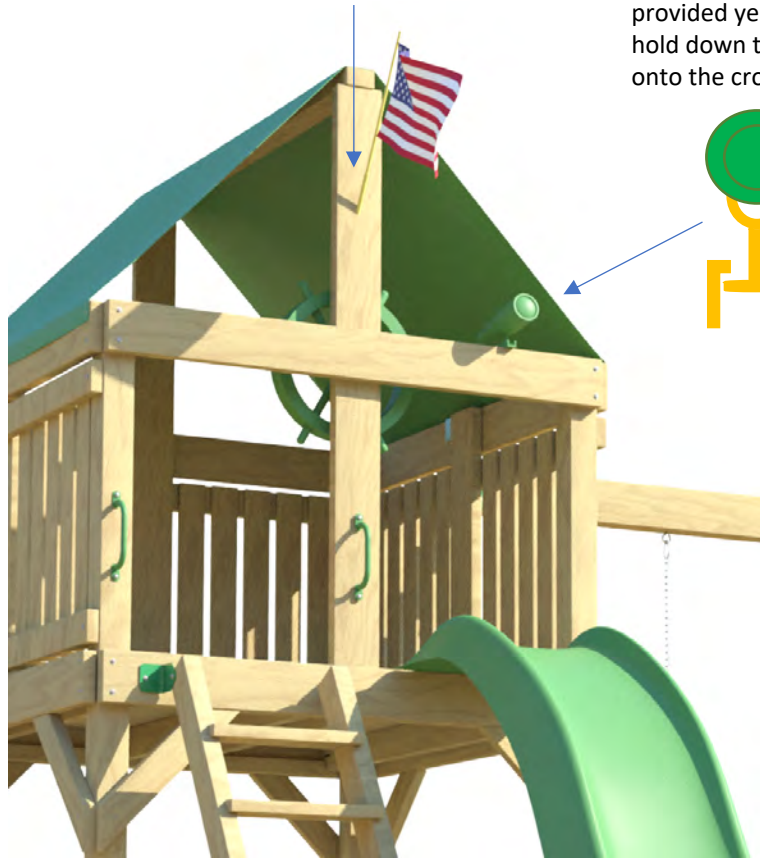

YOUR SWINGSET IS COMPLETE!

(oh, we provided extra screws, so don't worry if you still have a few screws leftover 😊)

© 2021



Ground Contact Points -> ■

NOTE: All Points should be at same elevation.
If at different elevations, contact Customer Service 888-525-1185 to discuss your options.

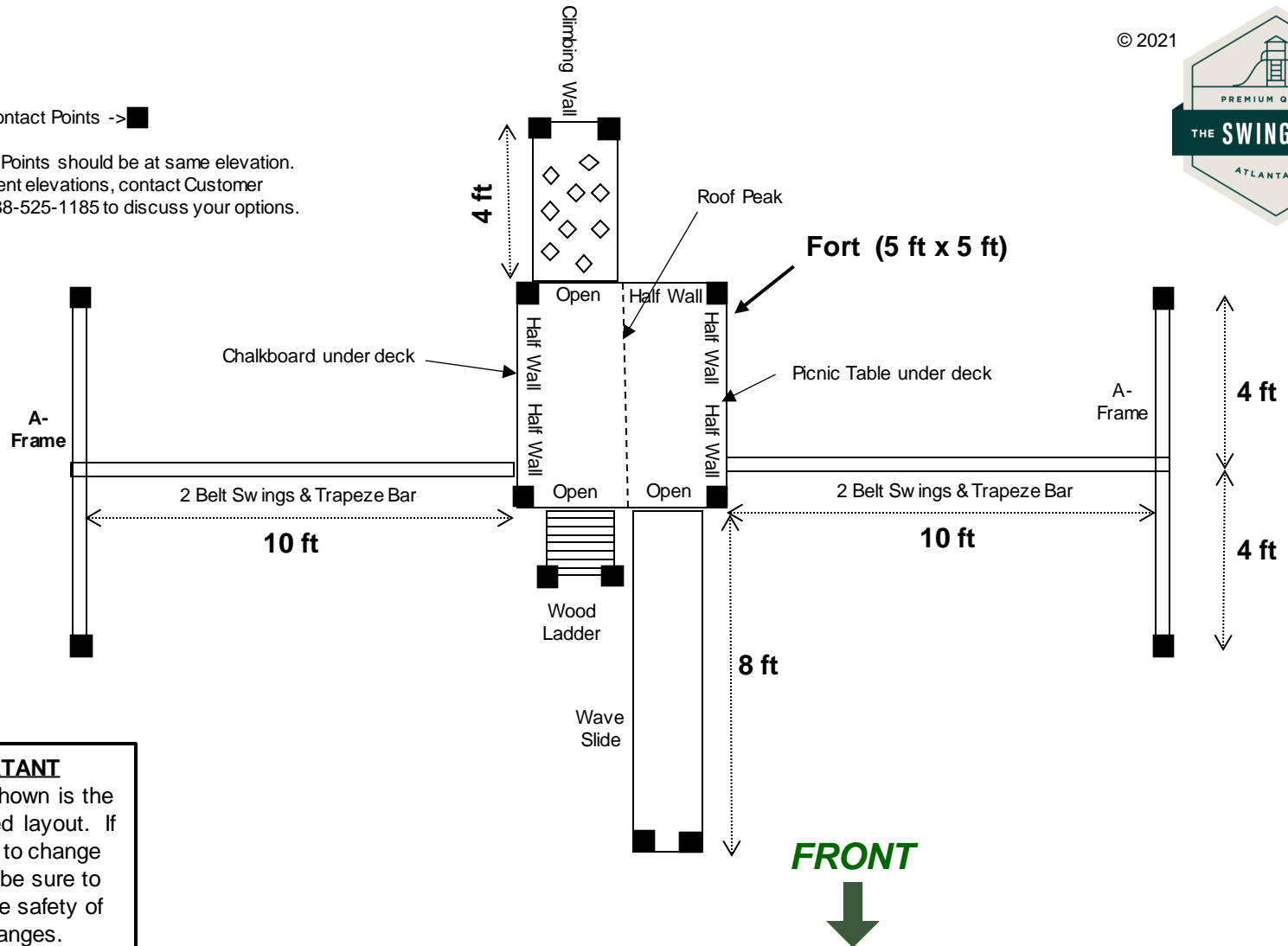

IMPORTANT
 The layout shown is the recommended layout. If you decide to change the layout, be sure to evaluate the safety of your changes.

Overall dimensions: Front to back:17 ft. Left to right:25 ft.

SWING EXTREME Layout Diagram