



# INSTALLATION INSTRUCTIONS

## Pioneer

Need a hand? Give us a call. 888.525.1185

Also, feedback is appreciated. If you think any part of this manual is confusing, or if you have suggestions for how to better explain one of the steps, please let us know by emailing [info@theswingsetco.com](mailto:info@theswingsetco.com)

**The Swingset Company** (TSC) team has designed the easiest playset to assemble (in our humble opinion :) We've pre-drilled all the holes, sanded all the wood, and pre-assembled many of the parts for you. We even use the fewest variations of fasteners. We hope you find this assembly to be enjoyable and stress-free. But if you get stuck, don't hesitate to call us at 888.525.1185. Please let us know your thoughts when you're done. Happy Building!

## Tools Needed:



**Power or Hammer Drill**



**Bubble Level**



**90° Angle**



**1/2" & 11/16" Sockets & Wrench**



**#2 Phillips Head Screw Driver**



**6' Ladder**

**IMPORTANT:** These Instructions were written assuming you have firm, level ground or you have ensured the ground is the same elevation at the points where the posts and A-Frame legs touch the ground. **See the "Layout Diagram" at the end of this manual for reference.** If your ground is not the same elevation at all the ground contact points, it will still be possible to assemble this swing set, **however** you will need to ensure stability of the swing set (e.g. by attaching 4x4 post extensions where the posts or A-Frame legs may not be long enough to reach the ground.) TSC does **not** take any responsibility for an assembly where the ground is not fully level and the elevations at the ground contact points are not the same.

## Safety Instructions

1. This playset is intended for use in residential settings by children ages 3-11 years of age. Use in public settings will void the warranty and can cause unexpected component failure leading to injury or death.
2. The maximum safe weight on the Fort deck is 500 lb. Maximum weight for the Fort Extension Board is 200 lb. Maximum weight for the Swing Beam is 400lbs for the 2-swing models; 600lbs for the 3-swing models (or 200lbs per swing).
3. As your swing set acclimates to its new environment, natural characteristics of the wood can show in the form of checks, or "cracks" in the lumber. In almost all cases this is normal and it will not affect the structural integrity of your play set and is not covered under warranty.
4. As with any home project, good judgment and respect for power tools will greatly reduce the risk of injury. Follow all tool manufacturers' safety guidelines. Always wear eye protection and safety gloves to prevent injury.
5. While the play set is being constructed, please keep children off the equipment until the project is complete.
6. The Swingset Company (TSC) shall not be liable for incidental, indirect or consequential damages or injuries that result from building and/or playing on our play sets. Adult supervision is recommended anytime a play set is being used.
7. TSC recommends that the weight limits for all components must not be exceeded. Failure to adhere to these and other safety guidelines could result in damage to the play set and injury to the users.
8. Your children's safety is our #1 concern. Observing the cautions in this manual and those of the associated options reduces the likelihood of serious or fatal injury. Please review these safety rules regularly with your children.



# SECTION 1

## The Fort Frame

Before you start, find the box labeled “Fort Accessories”. This is where you’ll find all your screws and the special drill bit required for assembly.





We’ve provided a few extra screws in each bag, just in case you lose a few 😊

## Step 1: Create Two A-Frames

Lay the four Posts (#1) on the ground as shown. Using the four Crossbeams (#2), construct two A-Frames as shown to the right. Place the Crossbeams (#2) between the lines as shown in figures A & B. Make sure the Crossbeams are completely square & perpendicular to the Posts. Attach using two "A" Screws at each end of the Crossbeam. Use the provided drill bit (T-25) to attach all the screws in this manual.

[Tip: use a 90 degree angle to ensure the beams are square & perpendicular]

**Parts Needed:**

	<b>x4</b>
	<b>x4</b>
	<b>x16</b>
	<b>x1</b>

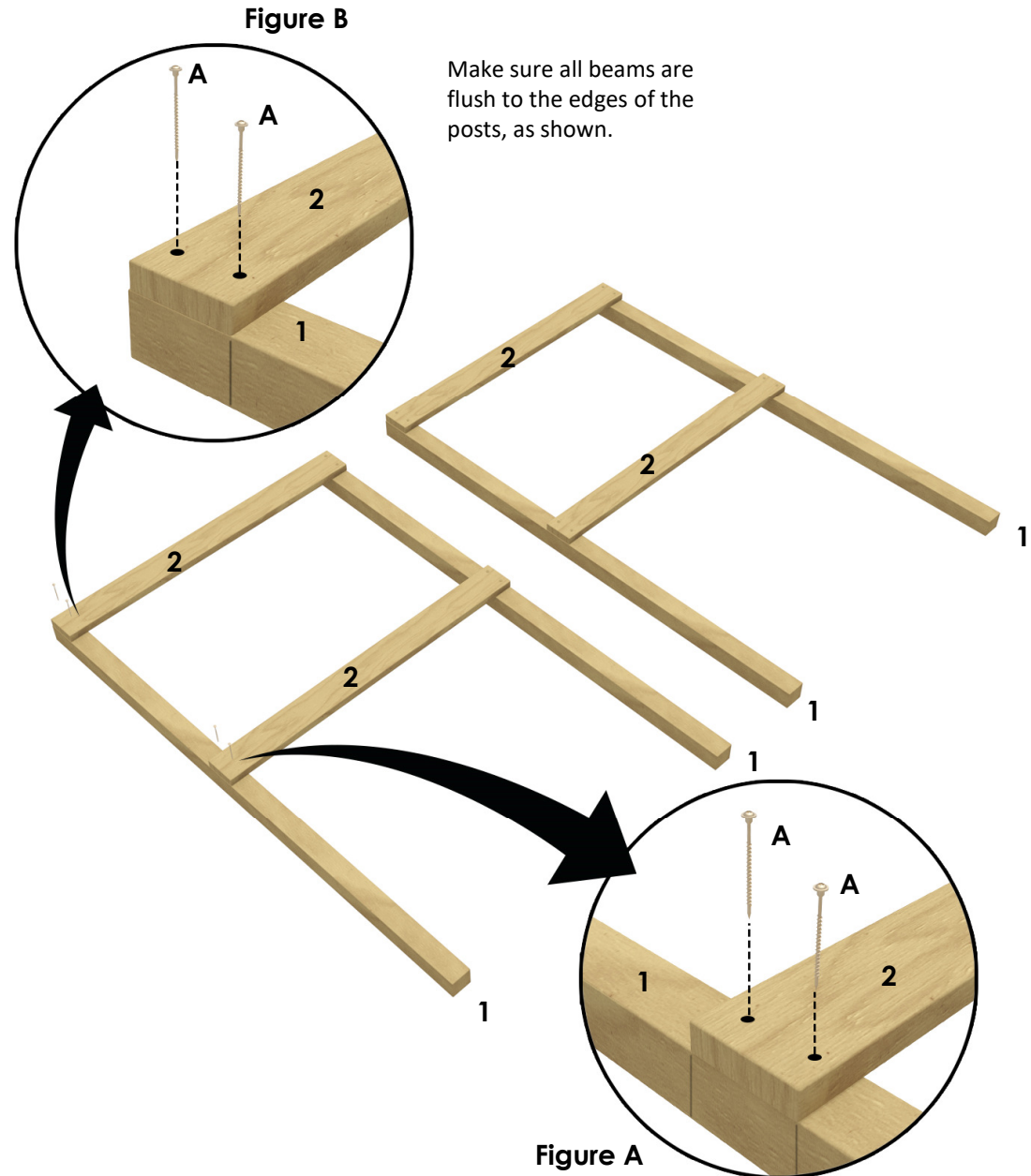

## Step 2: Attach 2 Floor Beams

Turn one of the A-Frames over so the Crossbeam side rests on the ground. Attach the Floor Beams (#3) to the Posts (#1) using two "A" screws in each side, see Figure C. Make sure the Floor Beams (#3) are aligned between the lines of the posts, and the bottom edges are flush to the bottom edges of the posts, as in the prior step.

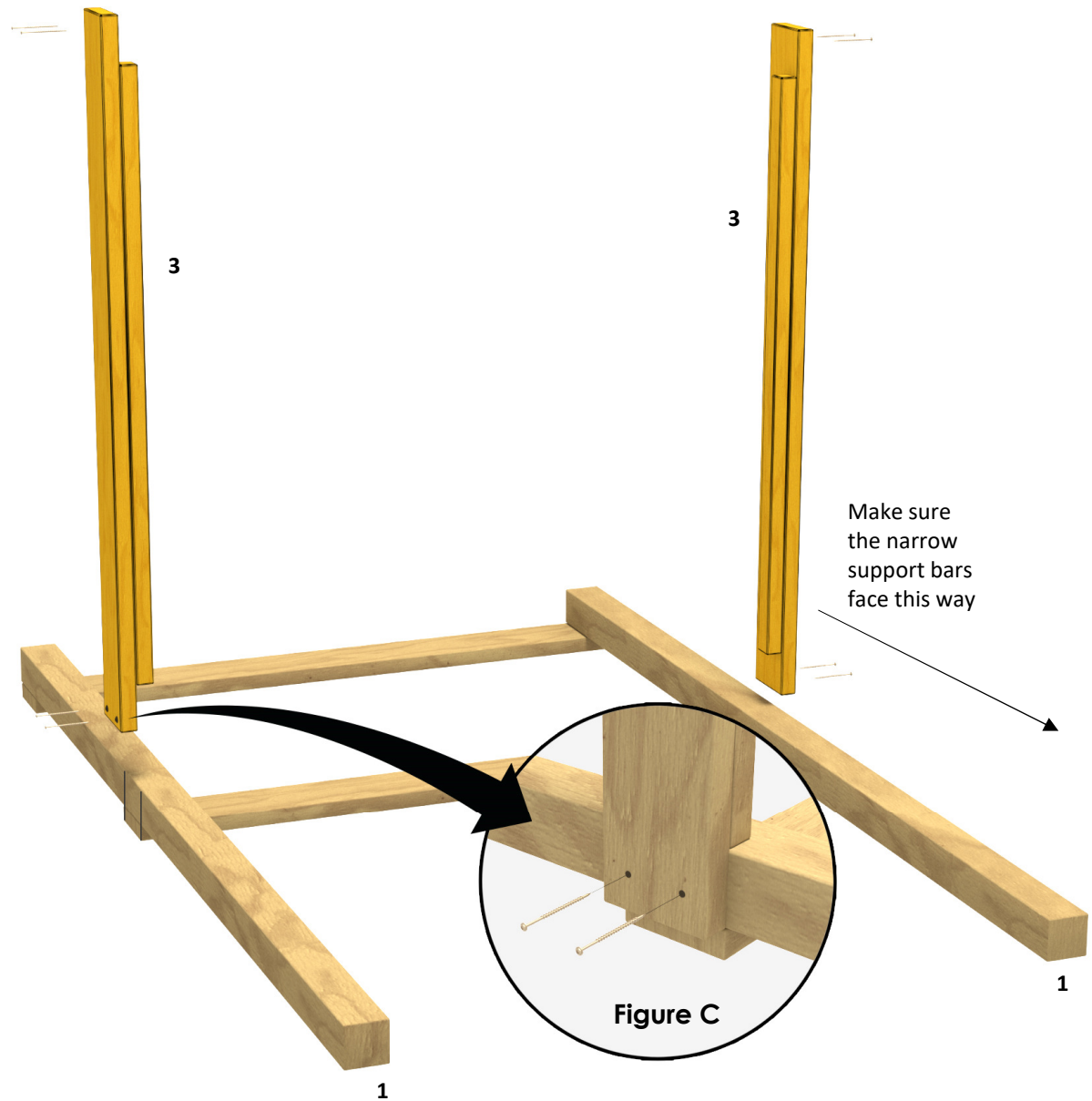
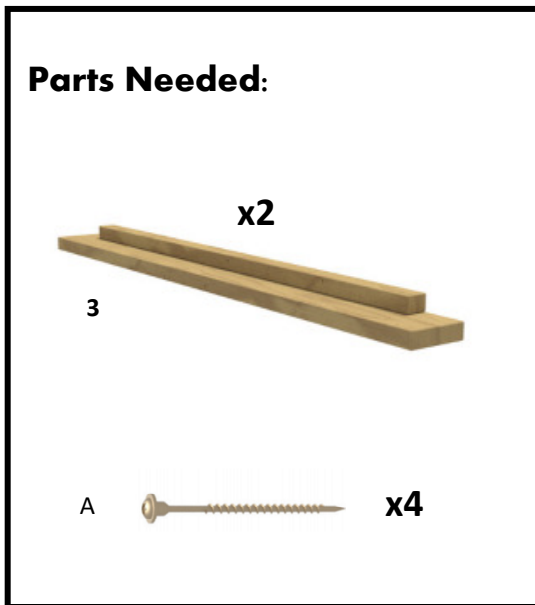

### Step 3: Connect Both A-Frames

You'll need your friend for this next part. Stand up the A-Frame with the attached Floor Beams, and place it opposite the other "A" Frame.

Align the Floor Beams with the lines on the posts of the other A-Frame. Use a bubble level to make sure all beams are horizontal and level. Secure using two "A" screws on each side, see Figure D.

**IMPORTANT:** The ground beneath each post must be at the same level to ensure all beams are horizontal and square.

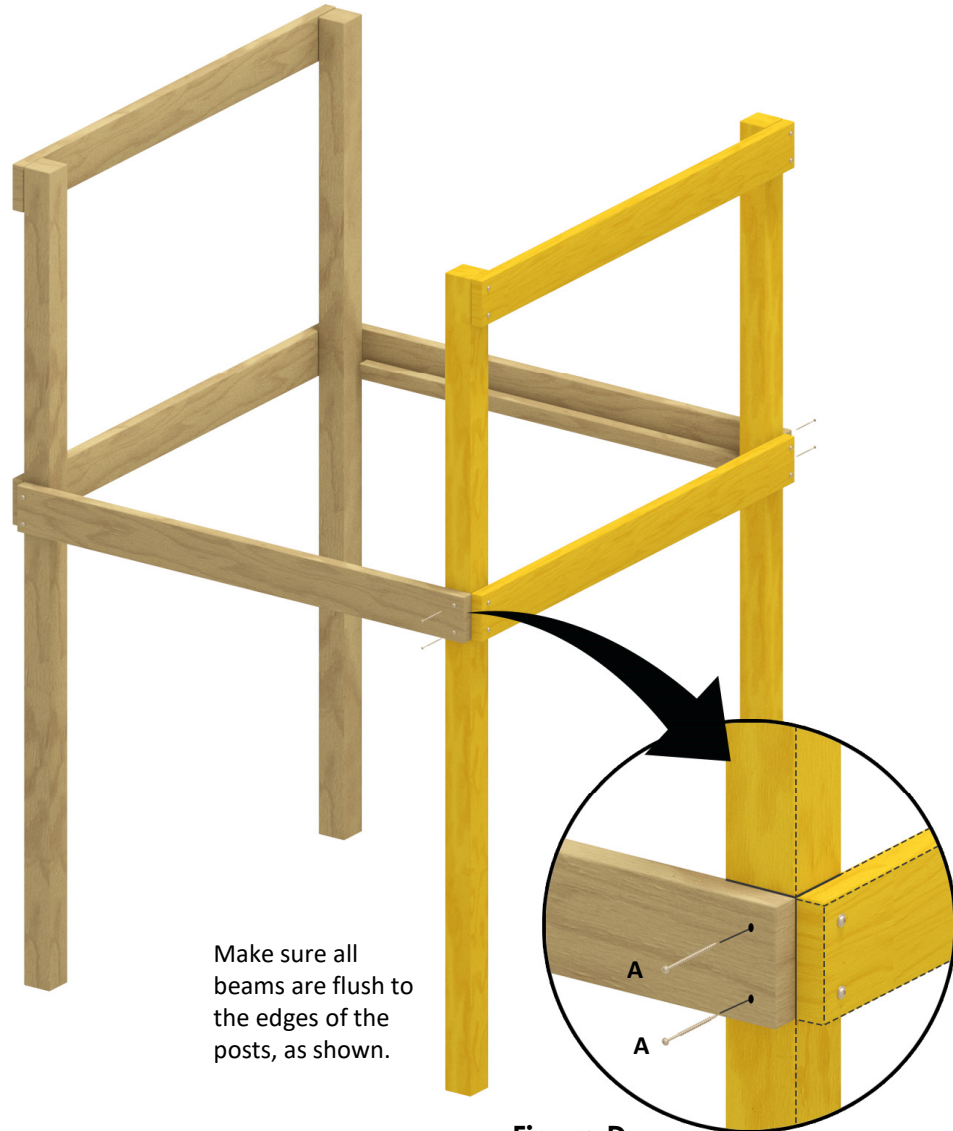
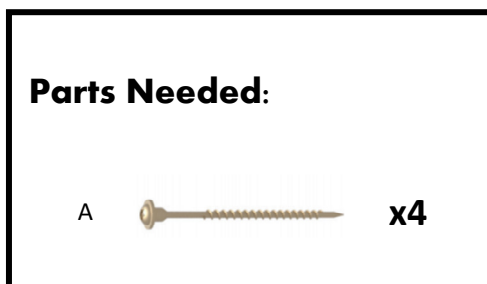



## Step 4: Attach Braces

Find the box that says “Braces”. Attach the 8 Braces between the Posts (#1) and the Crossbeams (#2 & 3). Use two “A” Screws for each brace, as shown in Figure E.

**Tip:** Make sure the end of each Brace lines up with the edge of each Post and the bottom of the beam, see figure F.

**Parts Needed:**

	<b>x8</b>
<b>A</b> 	<b>x16</b>

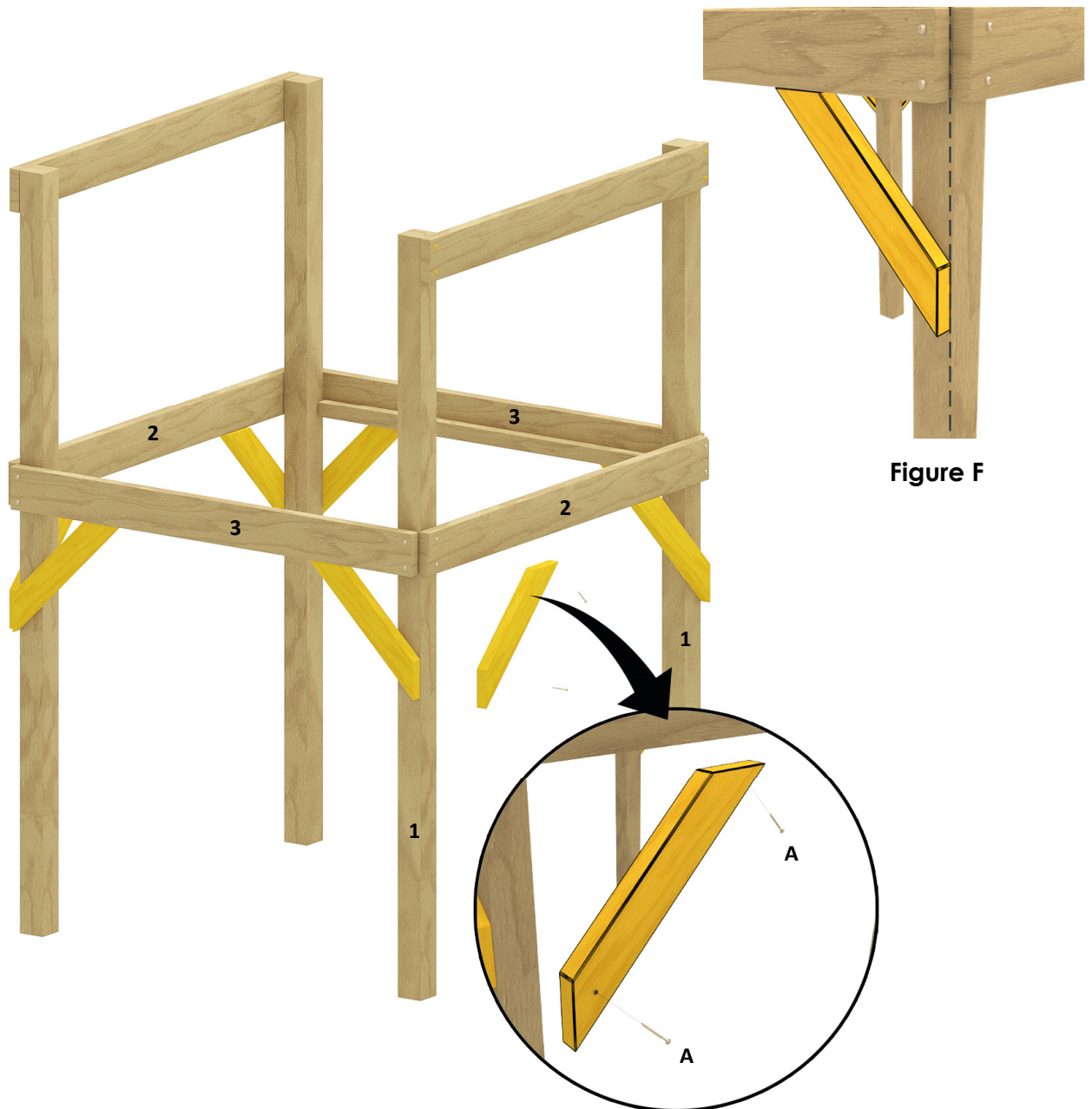

Figure E

Figure F



## Step 5: Install Deck Floors

You'll need your friend again for this step. Insert the two Deck Floors. They are identical. The cutout in the floor joists should rest on the support bars of the Crossbeams. Do NOT screw them into place yet.



## Step 6: Attach Ladder, Slide & Top Cross Beams

Note: The ladder and Slide can be placed on any side you wish.

Attach the Ladder using the instruction sheet and hardware provided with the Ladder.

Next, attach the Slide using three “B” screws. The screws should drill through the slide’s holes and into the bottom Crossbeam, see Figure G.

**Important: Make sure the Ladder is placed all the way to one side of the deck floor, and the Slide all the way to the opposite side. The two holes in the deck floor need to be between the Ladder and Slide.**

Finally, attach the last two Crossbeams (#2) using two “A” screws in each side, See Figure H.

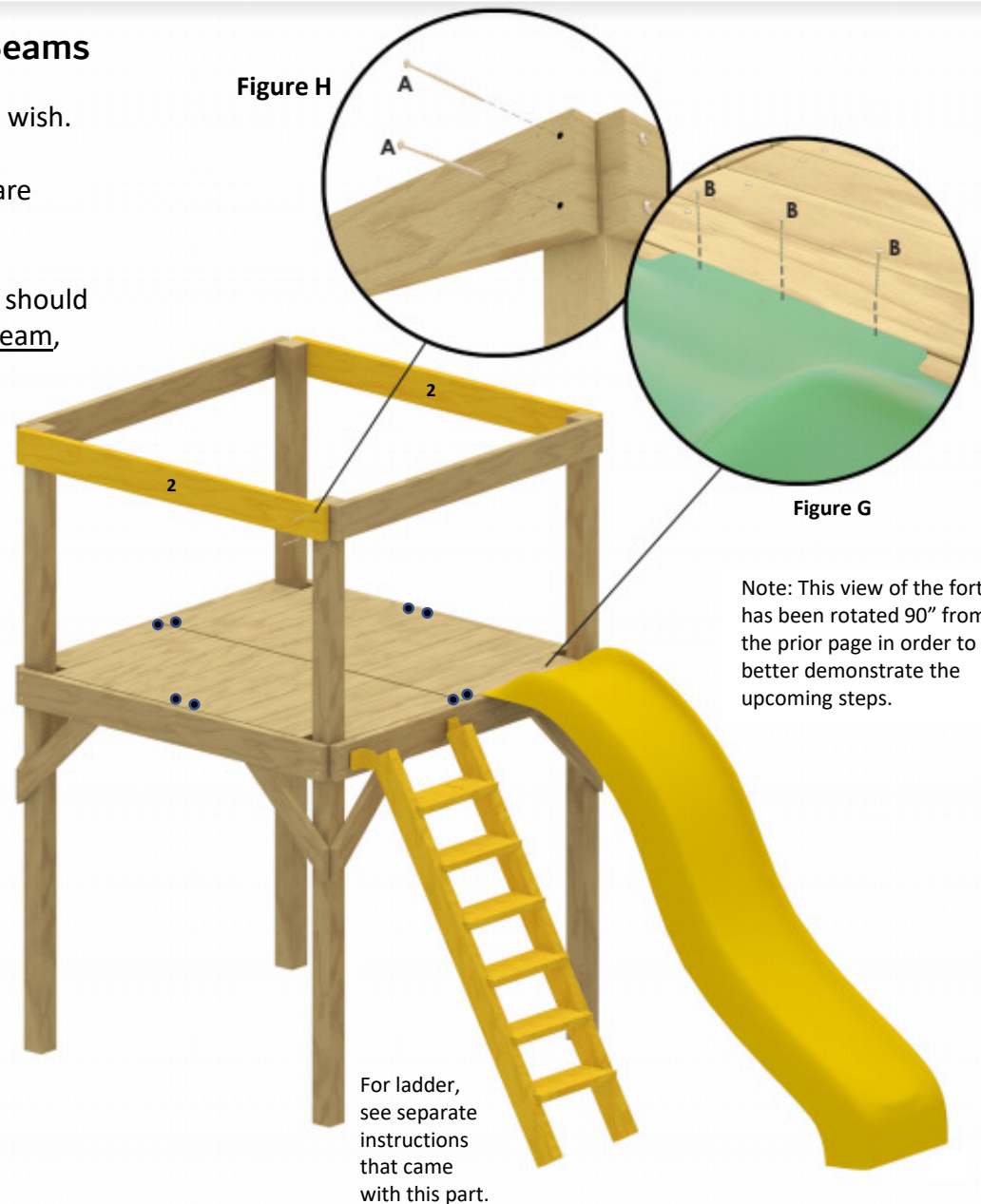
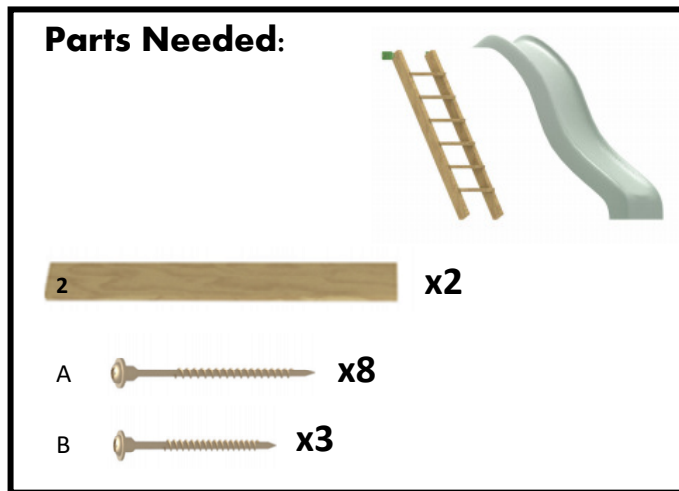

## Step 7: Attach Vertical Boards & Crossbar

Find the package “VERTICALS” containing the 4 parts below with the plastic stubs (2 tall & 2 short) and insert them into the holes on the deck floor (see picture to right). If need be, adjust the deck floors to fit the vertical stubs.







**IMPORTANT: Install the “Tall verticals” opposite each other, then do the same for the “Small Verticals”. Tall vertical should be placed between the slide and ladder.**

Make sure all verticals are truly vertical (use a bubble level to help check this), and attach to the upper Crossbeams (#2) using two “C” screws, see figure I.

Next, install the crossbar (#4) to the top of the Tall Verticals using two “C” screws, one on each end, as shown to the right.

Finally, install the 2 green safety handles which came with the ladder. One handle will attach to the Post, the other to the Tall Vertical.

**Parts Needed:**

4		x1
		
		
		
		
		x10

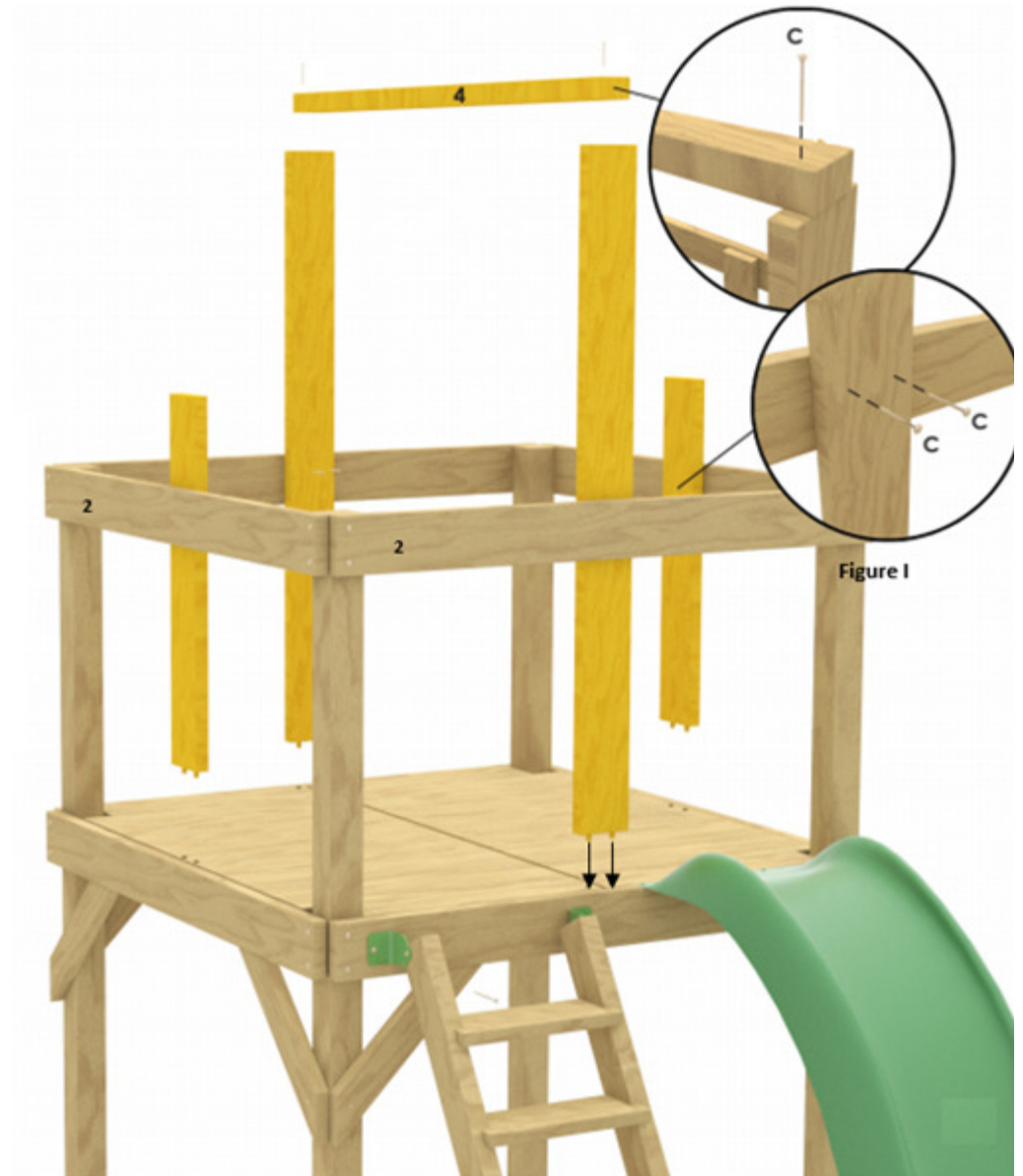

## Step 8: Screw the Deck Floors in Place

Now you can secure the deck floor using the 8 pocket holes under the deck floor. Use the “C” screws, as shown.

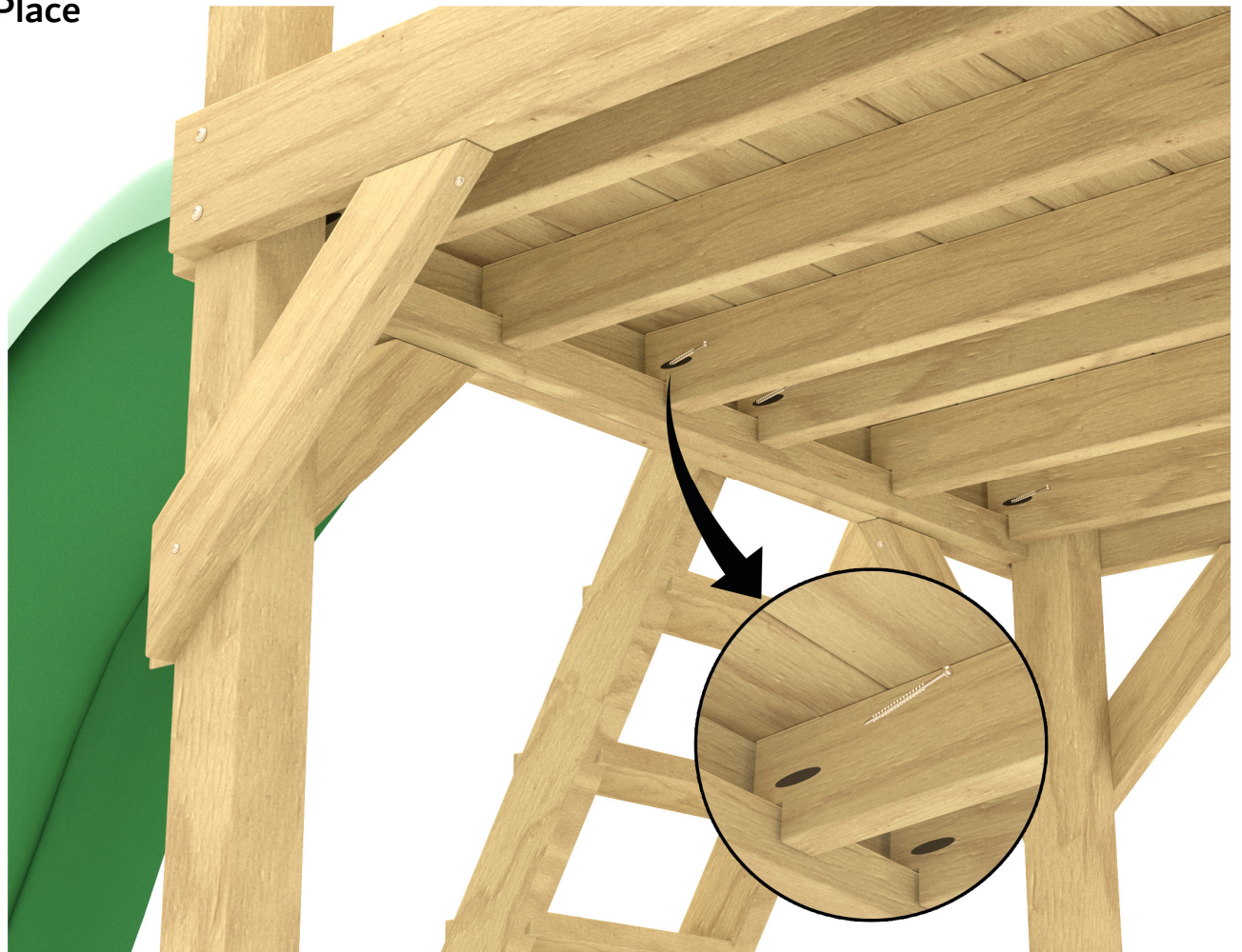

### Parts Needed:

c  x8



# GREAT JOB!

The Fort should look like this.

# **SECTION 2:**

## **“PIONEER” SWINGSET**

Walls, Extension Beams &  
Other Attachments

## Step 9: Attach Walls

Find the 6 walls and attach them as shown. Make sure to align the ends of each wall with the outside edges of the posts. Use one "C" Screw in each wall corner, See Figure K.

Figure K

Use 1 "C" Screw in each corner

Edge of walls must align flush with corners of each post

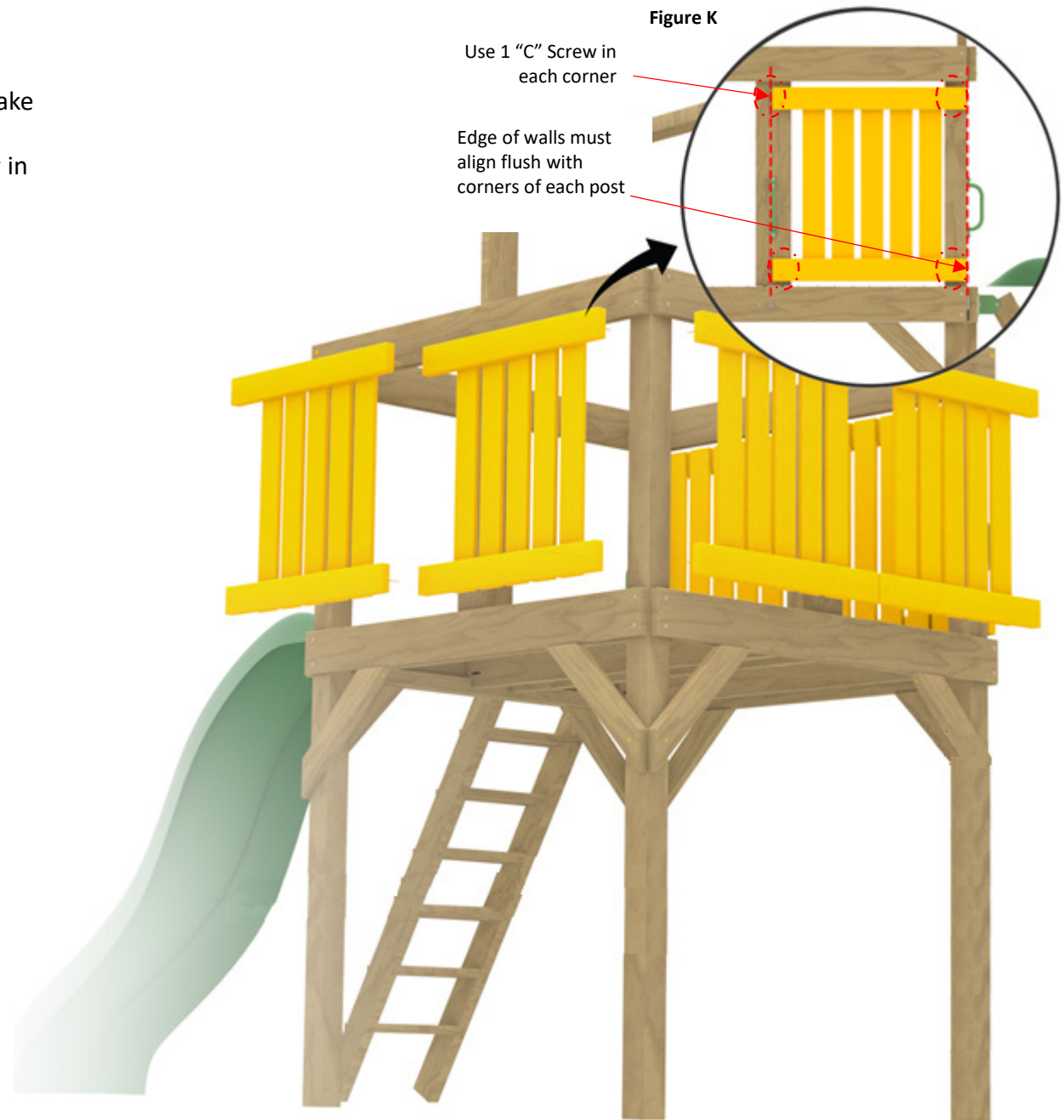
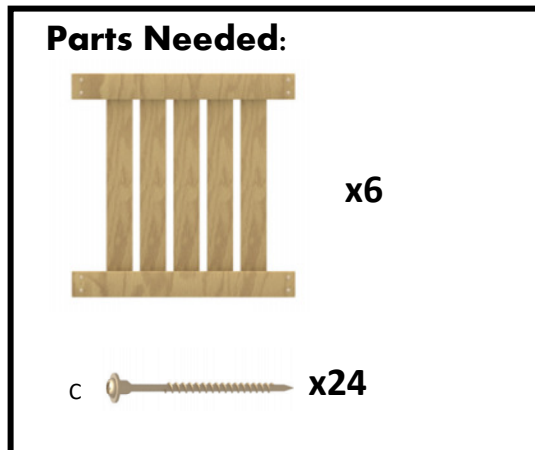

### Step 10: Attach the Extension Beam

Find the package called “Extension Beam Kit”. To attach the extension beam, use the instruction sheet and parts that came with that kit.

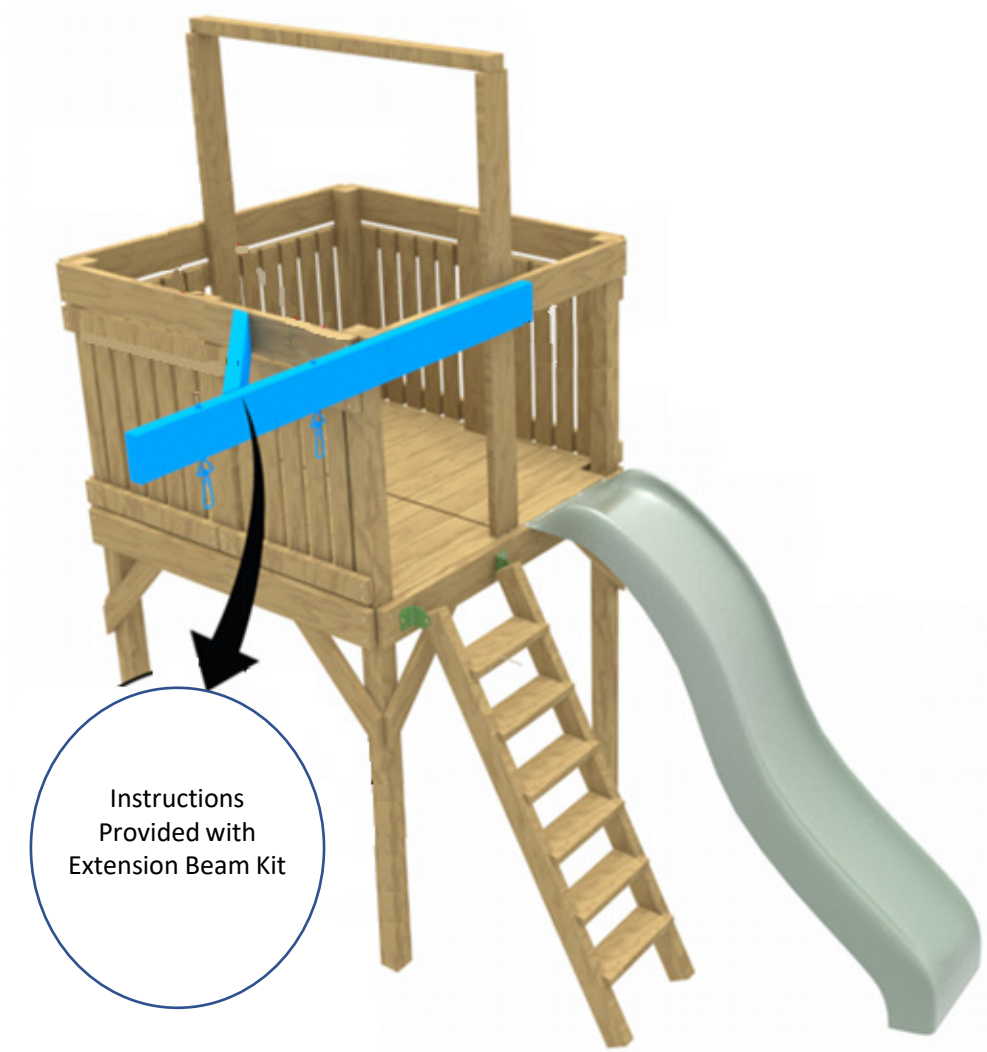



## Step 11: Hammock

Find the package called “Hammock”. To attach the Hammock, use the instruction sheet and parts that came with that kit.



3641 Clearview Parkway  
Atlanta, GA 30340

[www.TheSwingsetCo.com](http://www.TheSwingsetCo.com)

© 2020



3645 Clearview Parkway  
Atlanta, GA 30340  
[www.TheSwingsetCo.com](http://www.TheSwingsetCo.com)

© 2018

## Step 12A: Install Ground Beams

For the next 2 steps (12A & 12B), you will need 4 crossbeams (#2) and 2 diagonals (#11). You will also need 24 "A" screws, which can be found in the bag attached to the diagonals.

First, attach the four Beams (#2) on the bottoms of each Post, as shown to the right. Use the "A" screws provided, and drill two "A" screws in each end of the beams. Make sure these Beams are level and touching the ground (you may need to level the ground to do this).

### Parts Needed (12A)

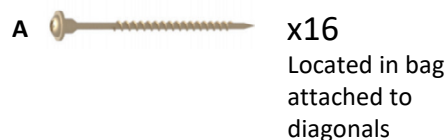

PIONEER by The Swingset Company

## Step 12B: Install Diagonal Beams

Next, attach the two diagonal beams (#11), as shown to the right. Use 2 "A" screws in each end to attach to the post.

**Important:** Make sure the second diagonal beam is placed on the opposite side of the fort and rising in the opposite direction as the first diagonal beam.

### Parts Needed (12B)

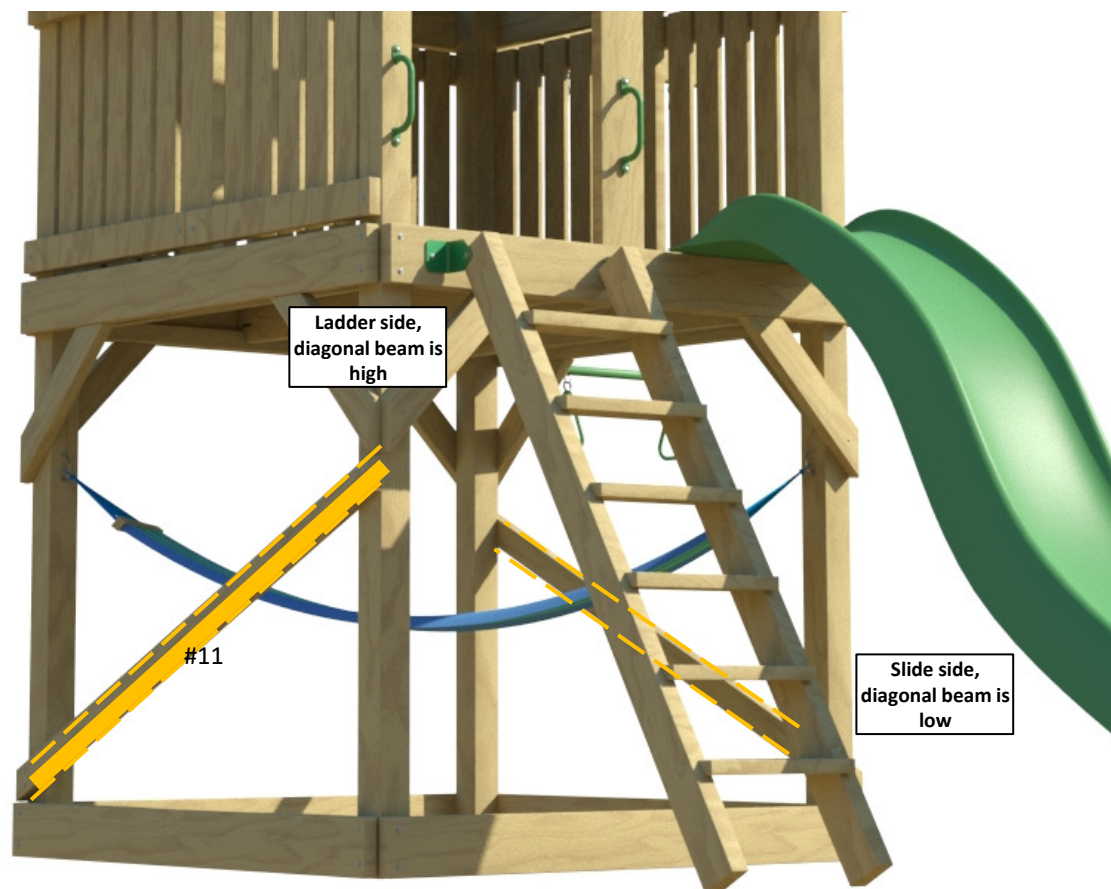
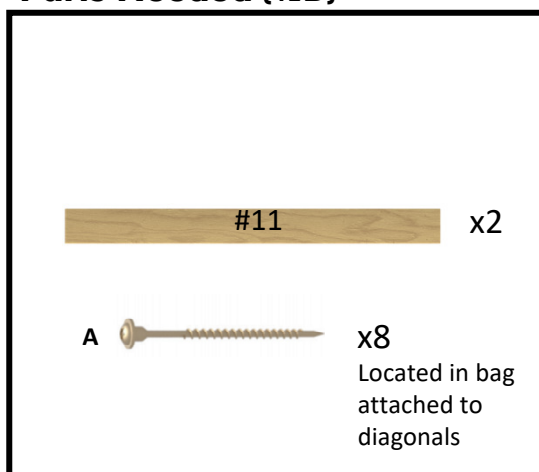



### Step 13: Install Tarp Roof

Spread Tarp evenly over top bar as shown.

While a helper holds the opposite side in one corner, pull the tarp tight. Adjust as needed to keep the sides even.

Secure to top beam with one "B" screw per grommet hole. Repeat until all grommets are secured

#### Parts Needed:



x1



x8

## Step 14: Ship Wheel, Telescope & Flag.

Insert flag into existing hole, which has been predrilled.

For the telescope, use the provided yellow "L" brackets to hold down the telescope base onto the crossbeam.

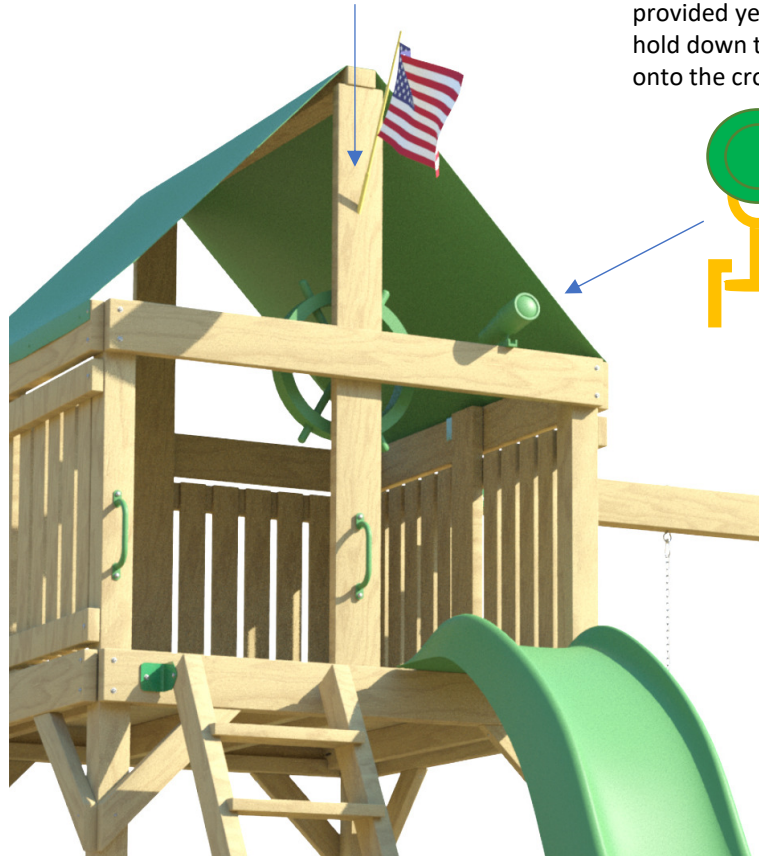

Finally, it's time to install the ship wheel, telescope and flag.

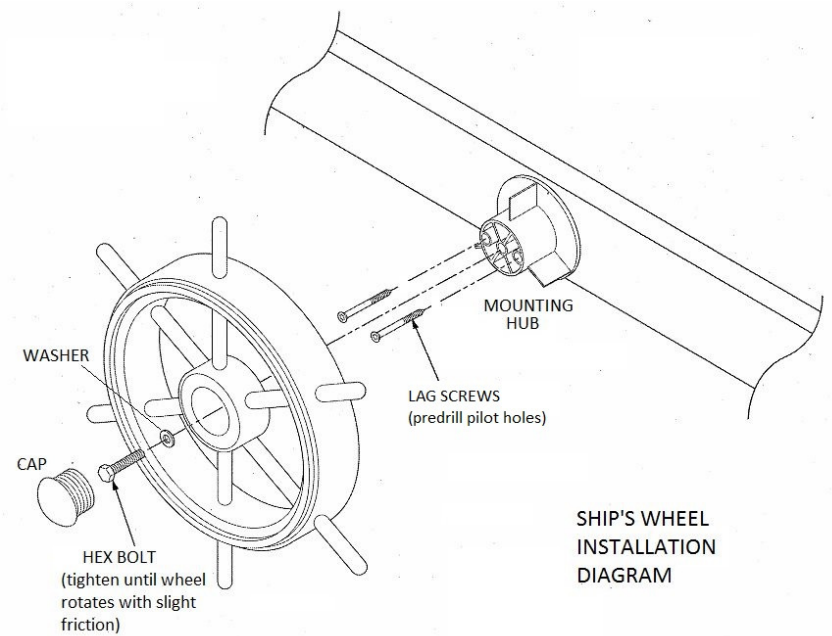

**YOUR SWINGSET IS COMPLETE!**

(oh, we provided extra screws, so don't worry if you still have a few screws leftover 😊)