

# avenlur

## Palm by Avenlur

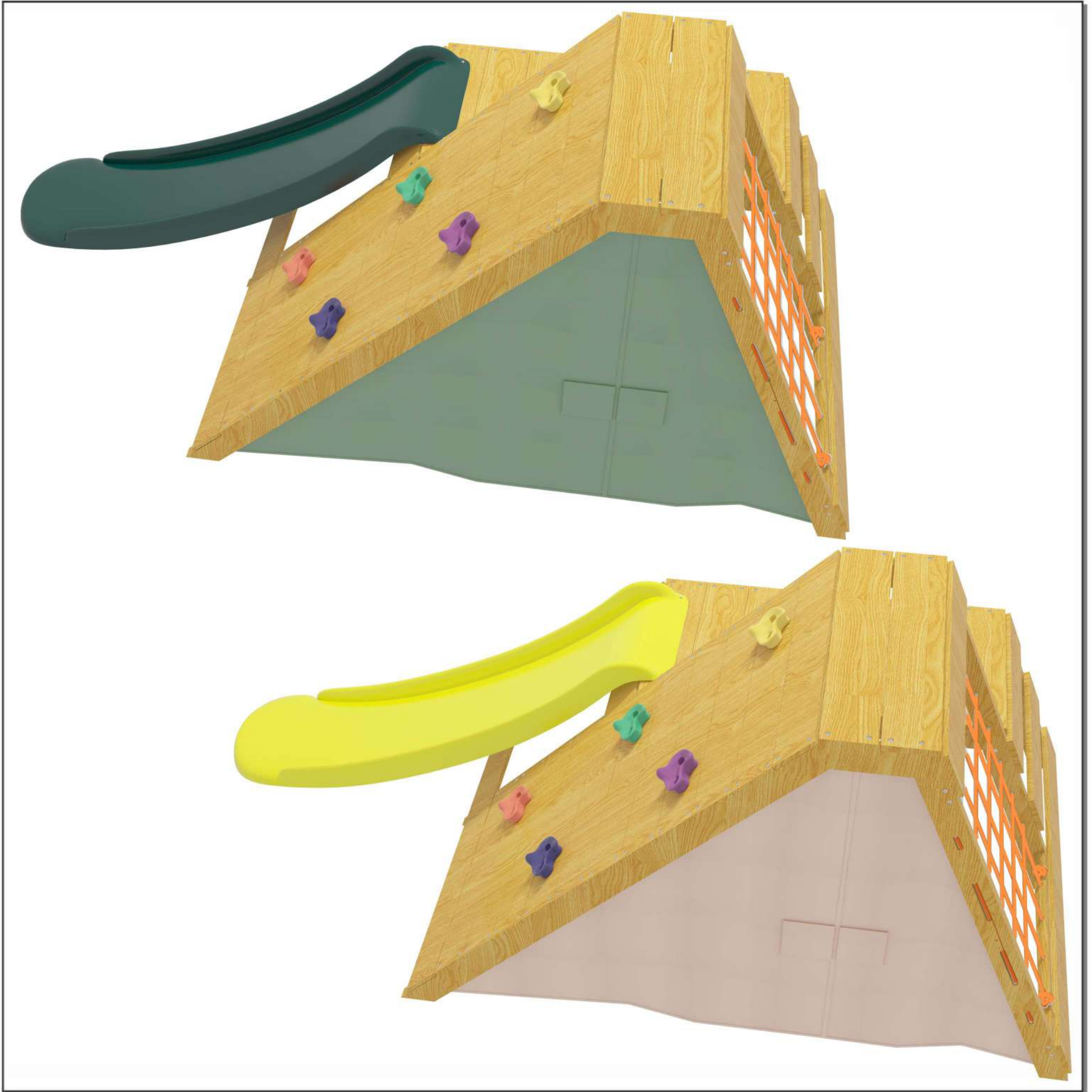

### Need Help?

CALL US AT 888.697.3931 / M-F 9AM - 5PM PT (12PM - 8PM ET)  
OR EMAIL US AT [INFO@AVENLUR.COM](mailto:INFO@AVENLUR.COM)

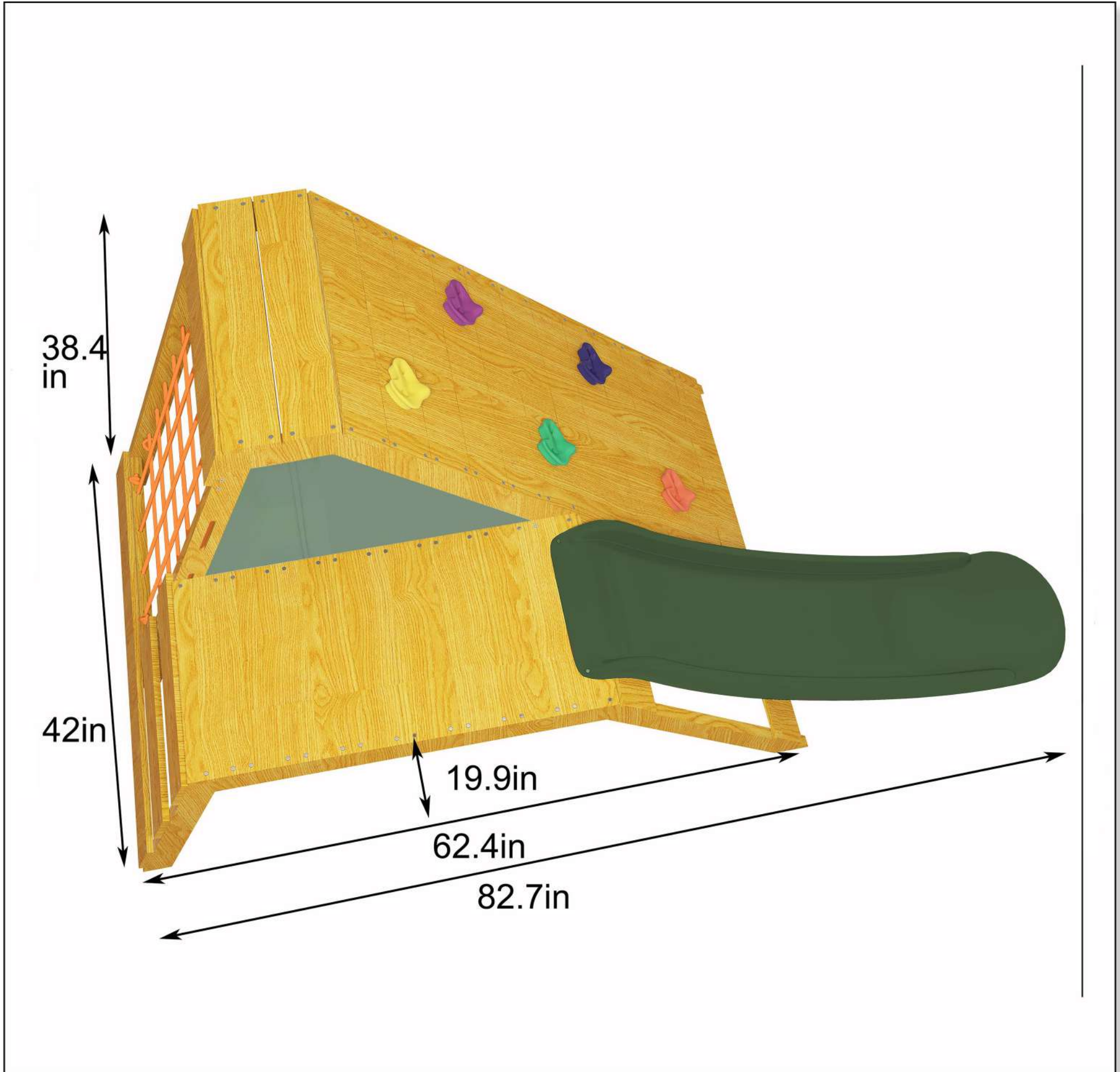

**FOR ADDITIONAL ASSISTANCE  
PLEASE CALL US AT 888-697-3931  
M-F 9AM-5PM PT (12PM-8PM ET)  
OR EMAIL US AT**

**[info@avenlur.com](mailto:info@avenlur.com)**

## CONTACT US BEFORE ASSEMBLY

If you have assembly questions or if you need parts  
whether they are missing or damaged

Call us at 888-697-3931 or email us at  
[info@Avenlur.com](mailto:info@Avenlur.com)

- ◆ READ THE ASSEMBLY MANUAL COMPLETELY, PAYING SPECIAL ATTENTION TO THE IMPORTANT TIPS AND SAFETY INFORMATION. WE ADVISE OUR CUSTOMERS TO HIRE PROFESSIONAL HELP FOR INSTALLING THIS PLAYSET.
- ◆ SEPARATE AND IDENTIFY ALL PARTS TO MAKE SURE THAT YOU HAVE ALL OF THE PARTS LISTED. IF YOU CAN'T FIND ALL OF THE PARTS, CHECK THE PACKING MATERIAL. SMALL PARTS MAY HAVE FALLEN OUT OF THE PACKET AND INTO THE MAIN BOX DURING TRANSIT.
- ◆ PLEASE HAVE AN ELECTRIC DRILL AVAILABLE FOR ASSEMBLY.
- ◆ PLEASE NOTE: THE WOOD IS TREATED WITH ANTI CORROSIVE TREATMENT WHICH MAY RESULT IN VERY SMALL CRACKS OR ROUGH SURFACES IN AREAS. THIS IS VERY NORMAL AND STANDARD. THIS WILL NOT AFFECT THE SAFETY AND STABILITY OF THE WOOD AND THE SWINGSET.
- ◆ WE HAVE USED A VARNISH PAINT DESIGNED FOR OUTDOOR USE. HOWEVER AS WITH ALL VARNISH PAINT THAT IS SUBJECT TO THE ELEMENTS. IT MAY BEGIN TO FADE AFTER A FEW YEARS. AT WHICH POINT YOU MAY PURCHASE PAINT FROM A LOCAL HARDWARE STORE AND RECOAT

## **PLEASE READ THIS BEFORE STARTING ASSEMBLY**

### **PLEASE HAVE THE FOLLOWING INFORMATION WHEN YOU MAKE YOUR CALL:**

- 1 – MODEL NUMBER OF THE PRODUCT LOCATED ON THE FRONT OF THE ASSEMBLY MANUAL
- 2 – DESCRIPTION OF THE PART FROM THE PARTS LIST

### **POR FAVOR TENGA VISIBLE LA SIGUIENTE INFORMACIÓN CUANDO LLAME:**

- 1 - NÚMERO DE MODELO DEL PRODUCTO QUE SE ENCUENTRA UBICADO AL FRENTE DEL MANUAL DE ENSAMBLAJE
- 2 - DESCRIPCIÓN DE LA PIEZA QUE SE ENCUENTRA EN LA LISTA DE PIEZAS

**Please read entire booklet completely before beginning the assembly process.**

Equipment is recommended for use by children 3-12 years of age. Structures are not intended for public use. Avenlur does not warranty any of its residential structures subjected to commercial use such as: Daycare, Preschool, Nursery School, Recreational Park, or any similar Commercial Application.



### **WARNING:**

This Symbol points out important safety instructions which, if not followed could endanger the personal safety of yourself and your children and/or damage your property. You **MUST** read and follow all instructions in this manual before attempting to use this playcenter.



### **WARNING:**

Children must **NOT** use this playcenter until unit has been completely assembled and inspected by an adult to insure set has been properly installed and anchored.

Please follow all recommendations below. **Failure to do so may result in the warranty being void and/or safety violations that could result in serious injury.** This manual contains helpful information concerning Assembly Preparation, Installation Procedure, and Required Maintenance. Always keep the safety of your children in mind as your play structure is being built and as your children play on the set. Before your children play on the set please review the Operation Instructions with them to help ensure their safety.

**PLEASE RETAIN THESE INSTRUCTIONS FOR FUTURE REFERENCE. KEEP THEM IN A SAFE PLACE ,WHERE YOU CAN REFER TO THEM AS NEEDED. IN ORDER TO PROVIDE YOU WITH THE MOST EFFICIENT SERVICE, IT IS REQUIRED THAT YOU PROVIDE US WITH THE PART NUMBERS WHEN ORDERING PARTS.**

## **Installation:**

1. Place the equipment on level ground, not less than 6ft (1.8 m) from any structure or obstruction such as a fence, garage, house, overhanging branches, laundry lines, or electrical wires.
2. Children must not use the equipment until properly installed.

## **Maintenance instruction:**

1. Tighten all hardware. Lubricate all metallic moving parts per manufacturer's instructions.
2. Check all protective coverings on bolts, pipes, edges, and corners. Replace if they are loose, cracked, or missing.
3. Check all moving parts including swing seats, ropes, cables, and chains for wear, rust, or other deterioration. Replace as needed.
4. Check metal parts for rust. If found, sand and repaint using a non-lead-based paint meeting the requirements of 16 CFR 1303.
5. Reinstall any plastic parts, such as swing seats or any other items that were removed for the cold season.
6. Rake and check depth of loose fill protective surfacing materials to prevent compaction and to maintain appropriate depth. Replace as necessary.

## **Twice a month during play season:**

1. Tighten all hardware.
2. Check all protective coverings on bolts, pipes, edges, and corners. Replace if they are loose, cracked, or missing.
3. Rake and check depth of loose fill protective surfacing materials to prevent compaction and to maintain appropriate depth. Replace as necessary.

## **Once a month during play season:**

1. Lubricate all metallic moving parts per manufacturer's instructions.
2. Check all moving parts including swing seats, ropes, cables, and chains for wear, rust, or other deterioration. Replace as needed.

## **Disposal Instructions**

There shall be instructions advising the owner to disassemble and dispose of the playground equipment in such a way that no unreasonable hazards will exist at the time the playground equipment is discarded.

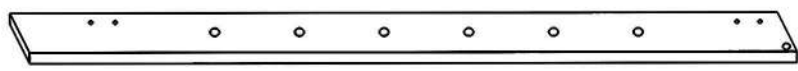

①×1 39.5in

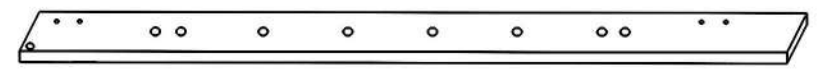

②×1 39.5in

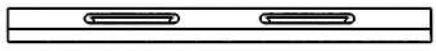

③×1 21.7in



④×1 21.7in

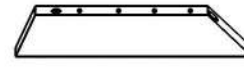

⑤×2 12.1in

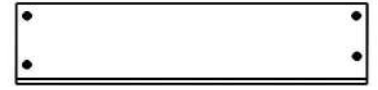

⑥×1 17.9in

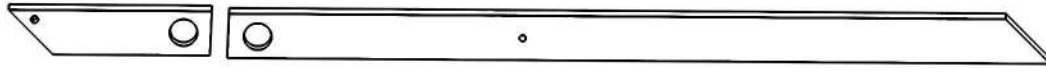

⑦×1 41.3in

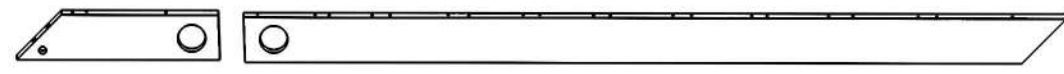

⑧×1 41.3in

②②×1 10.4in

②③×1 10.4in

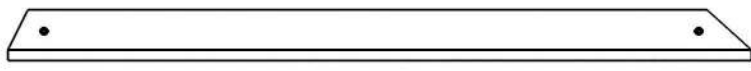

⑨×1 37.9in

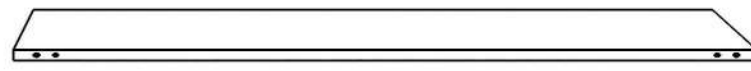

⑩×1 37.9in

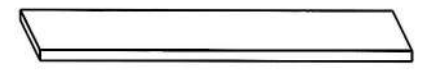

⑪×1 19.2in

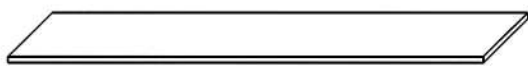

⑫×1 25.9in

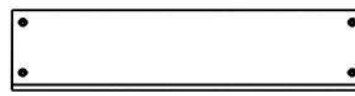

⑬×7 17.9in

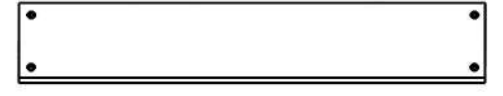

⑭×7 23.8in

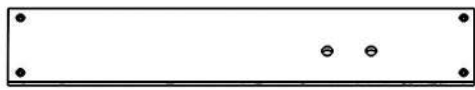

⑮×5 23.8in

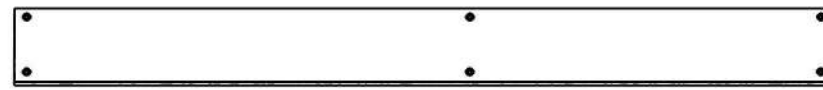

⑯×3 41.7in



⑰×1 23.8in



cover cloth

⑳×2



㉕×2 18.9in

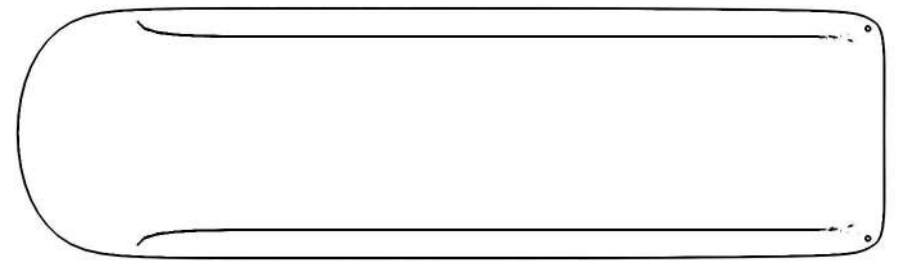

㉑×1 47.2in



⑱×1 177.2in



⑲×1 220.5in

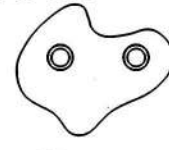

㉒×5



M5×30  
A×107



M5×16  
B×2



M5×50  
C×11

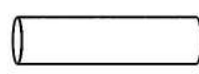

φ8×30  
D×10

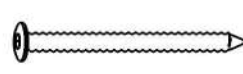

M6×60  
E×3



M6×80  
E1×3



M6×10  
F×6

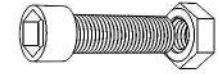

M10×40  
G×10

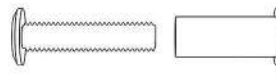

M6×50 M6×15  
G1×2

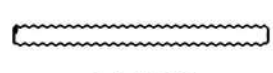

φ6×80  
H×2



I×4



M6×10  
J×4



φ40×5  
K×4



M4  
L×2



M10  
M×1

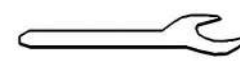

17mm  
N×1

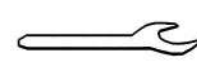

10mm  
O×2

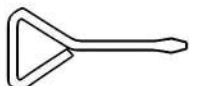

P×1

**A1-1** NOTE: Check all connections and bolts for tightness at least twice monthly during the usage. Prevent the product from being used normally due to screw loosening.

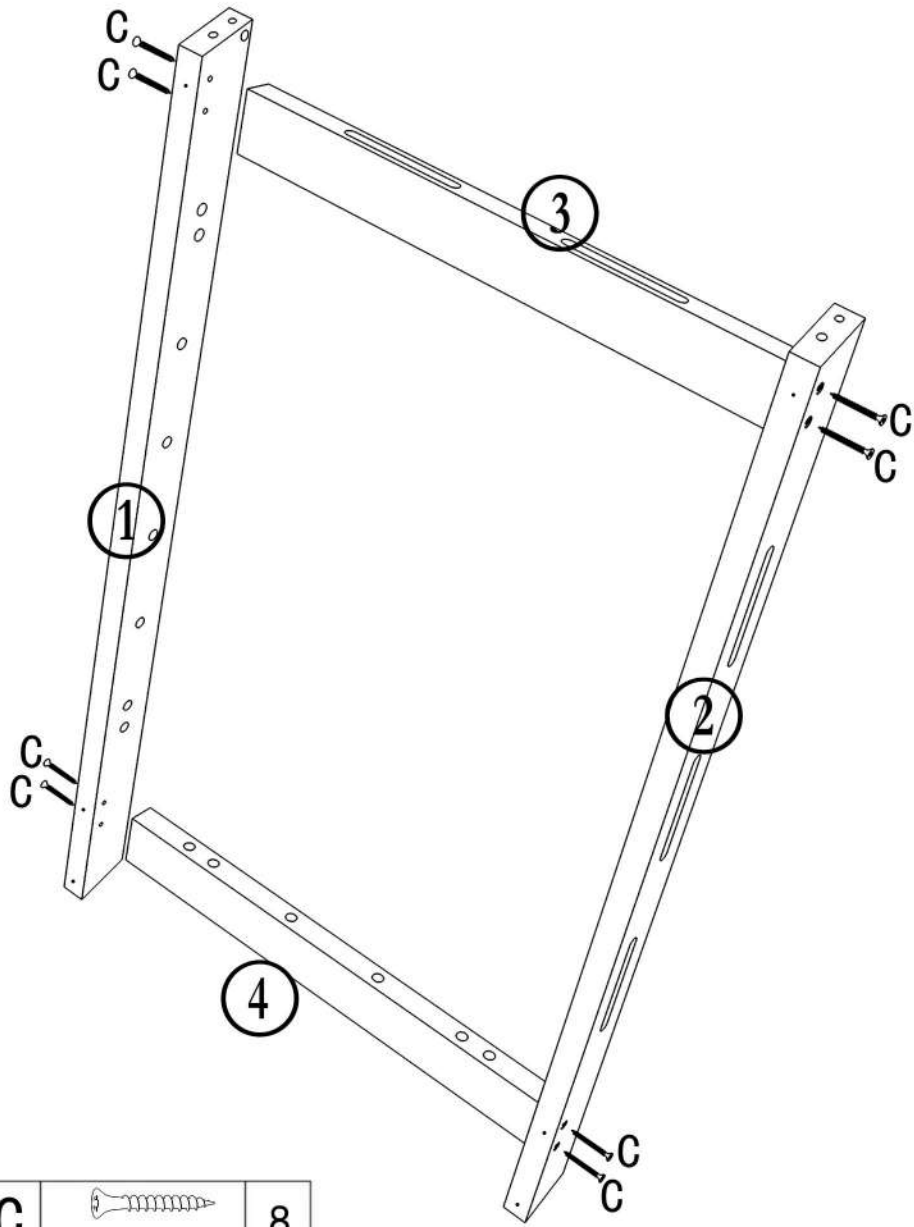

**A1-2** NOTE: The torque of the charging drill must be set to a minimum, or the wood will crack

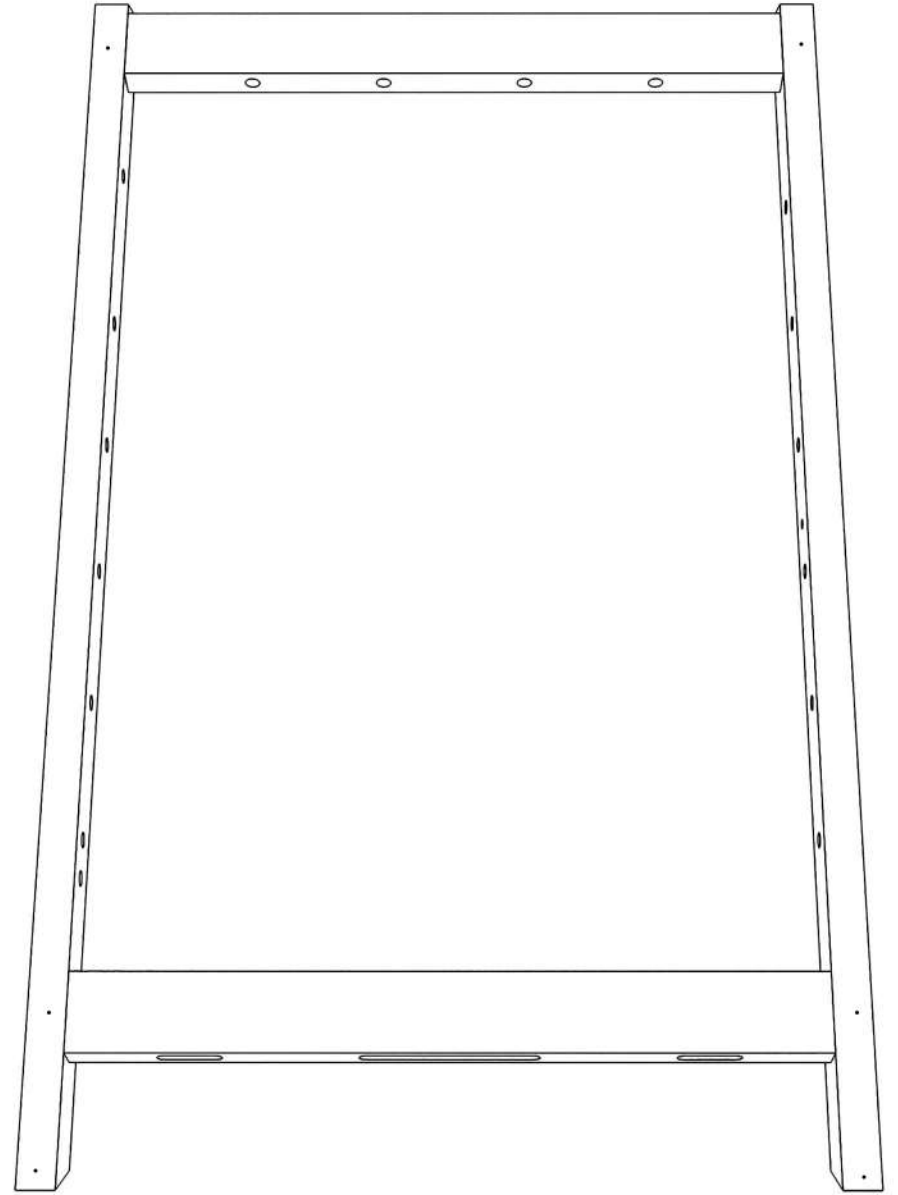

**A2-1**

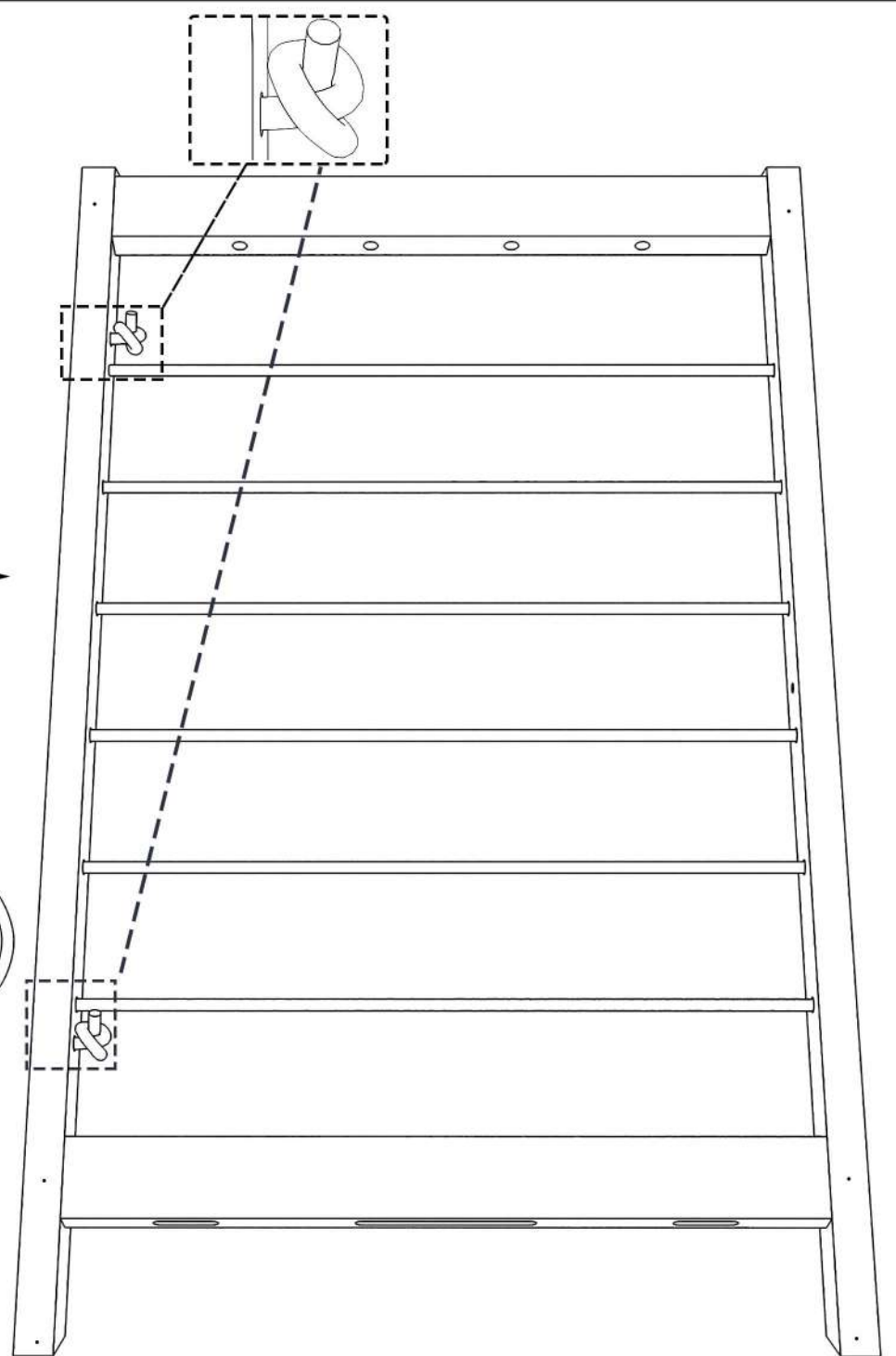
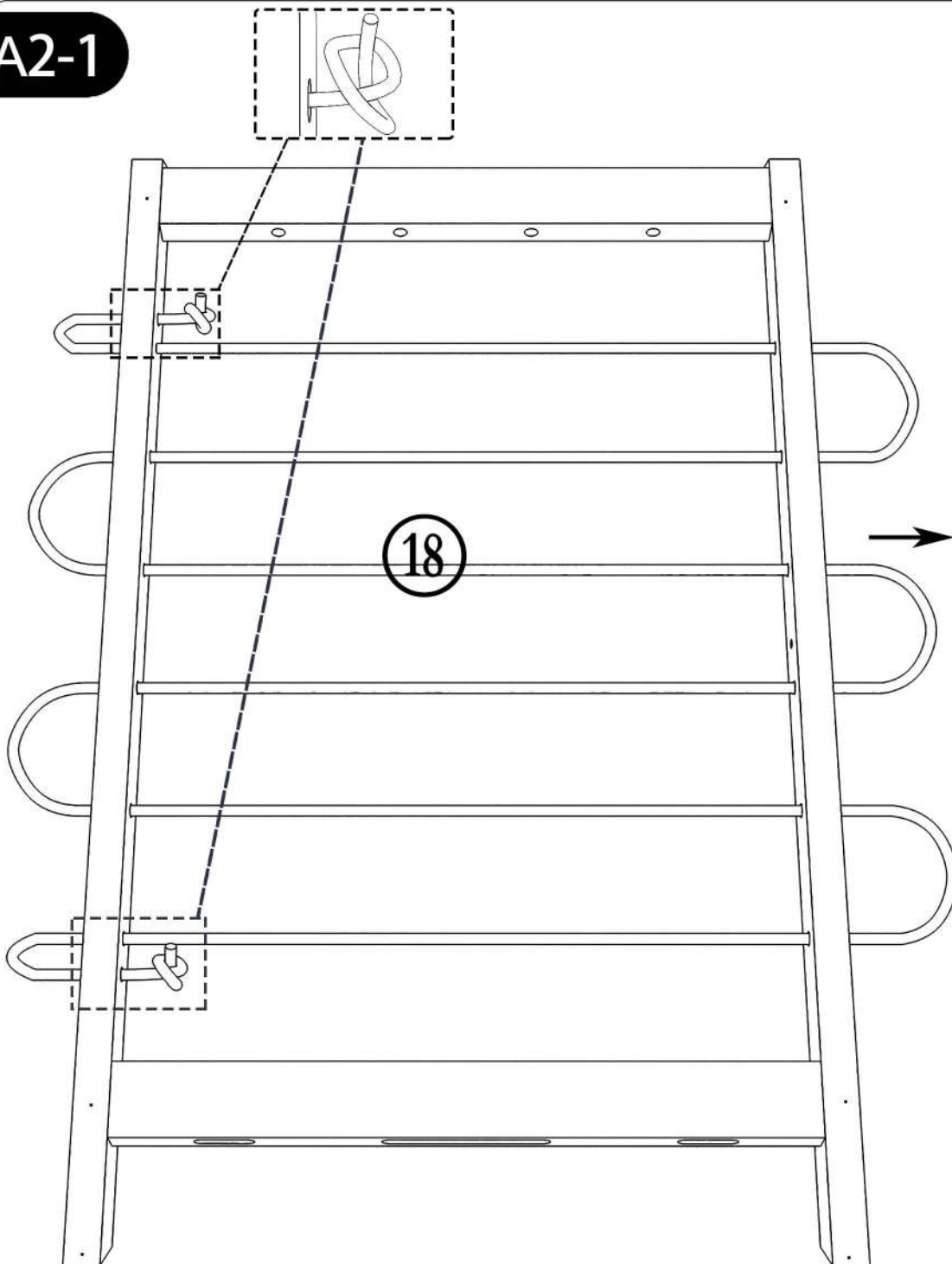

A2-2

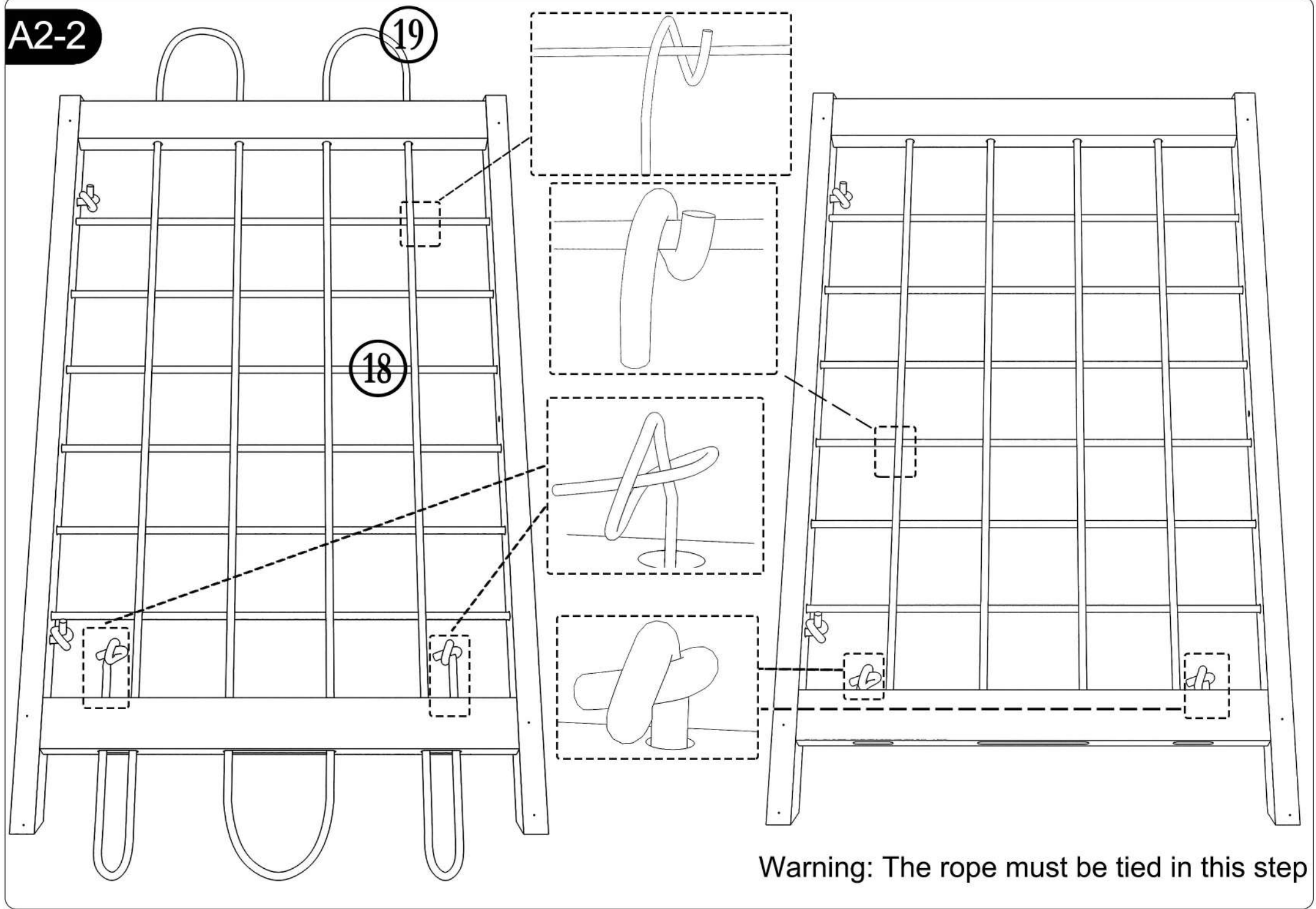

A1-A2

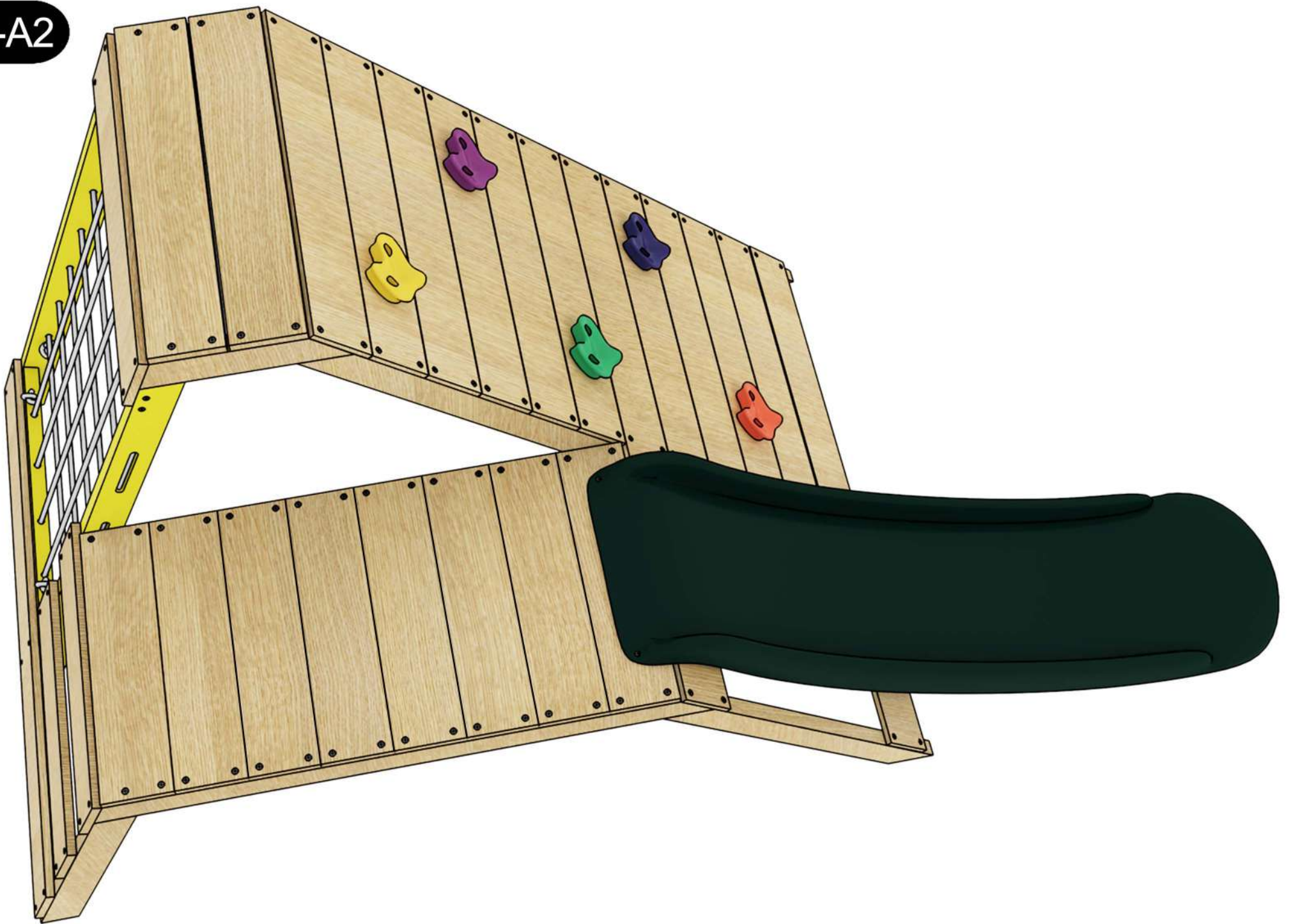



A3-1

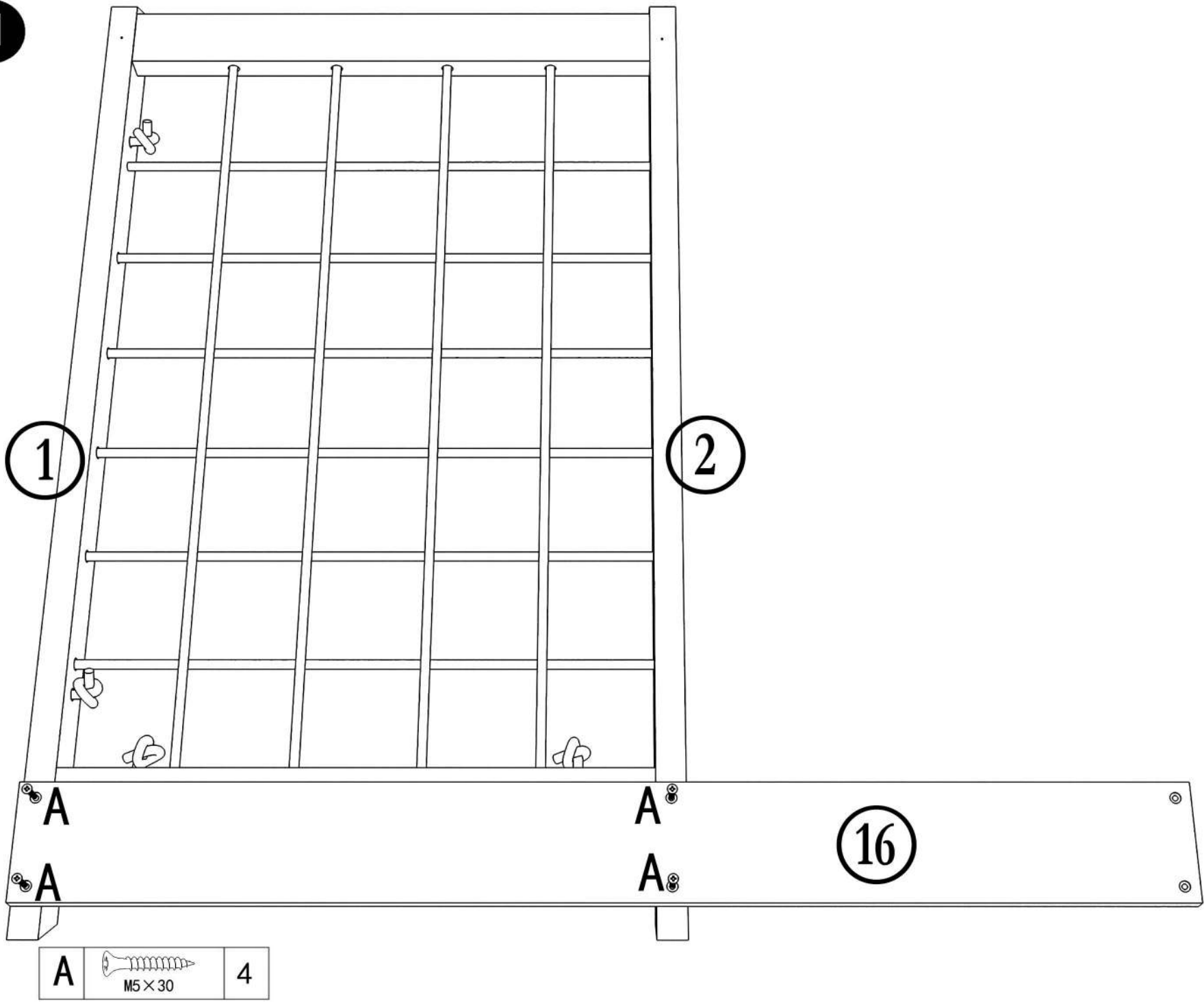

A3-2

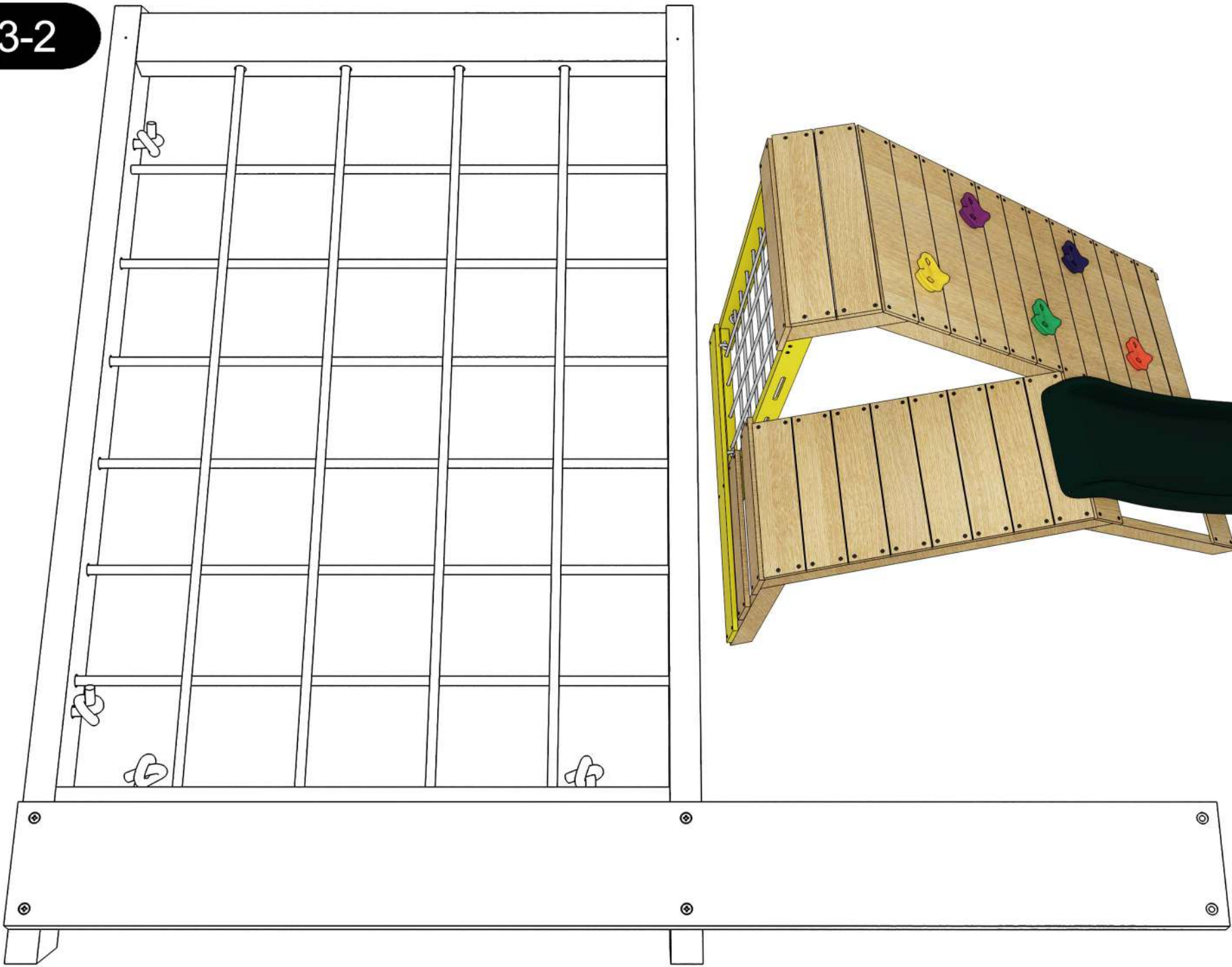

**B1-1**

NOTE: Install parts 20 on parts 15, note direction of parts 15 screw hole

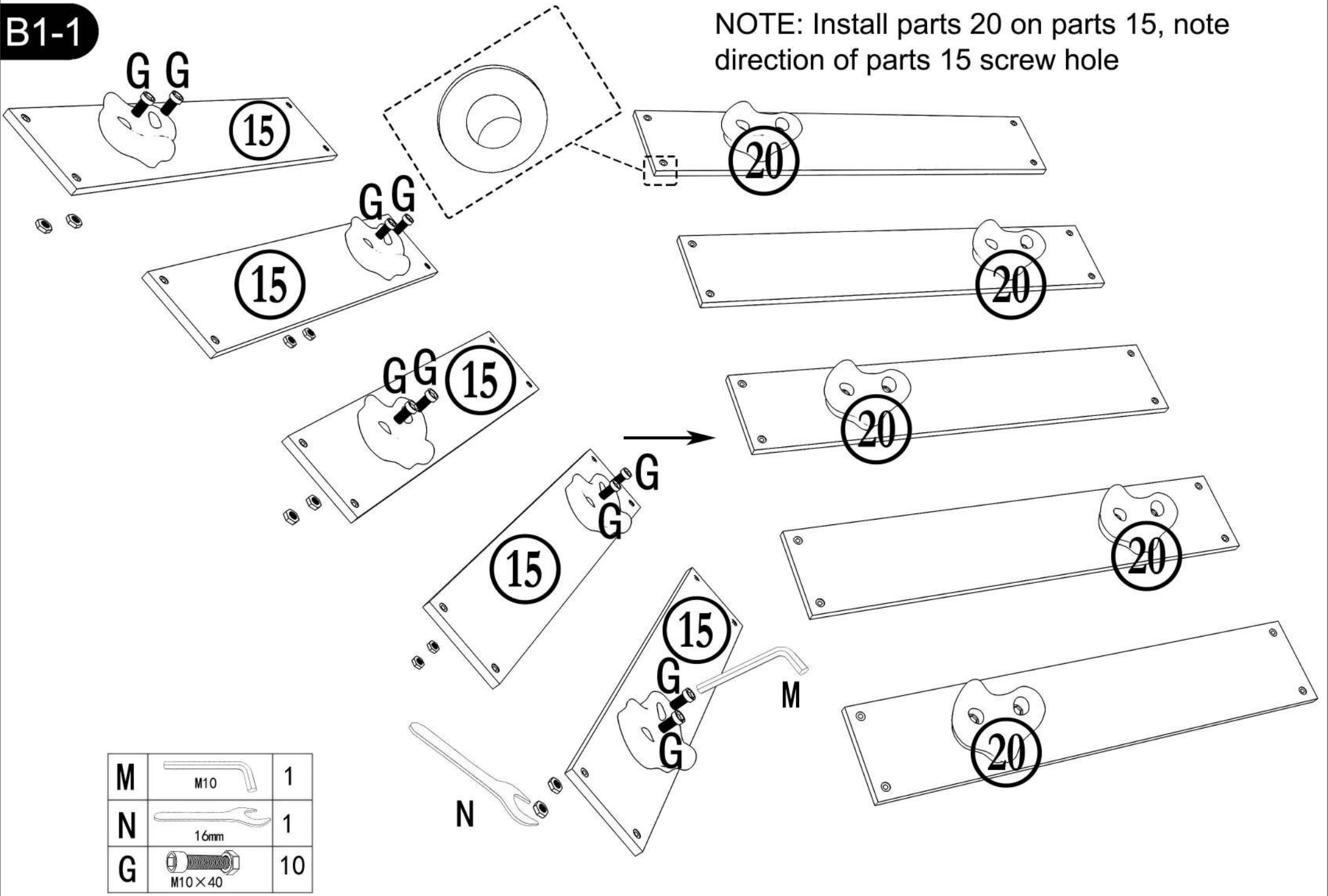

**B1**

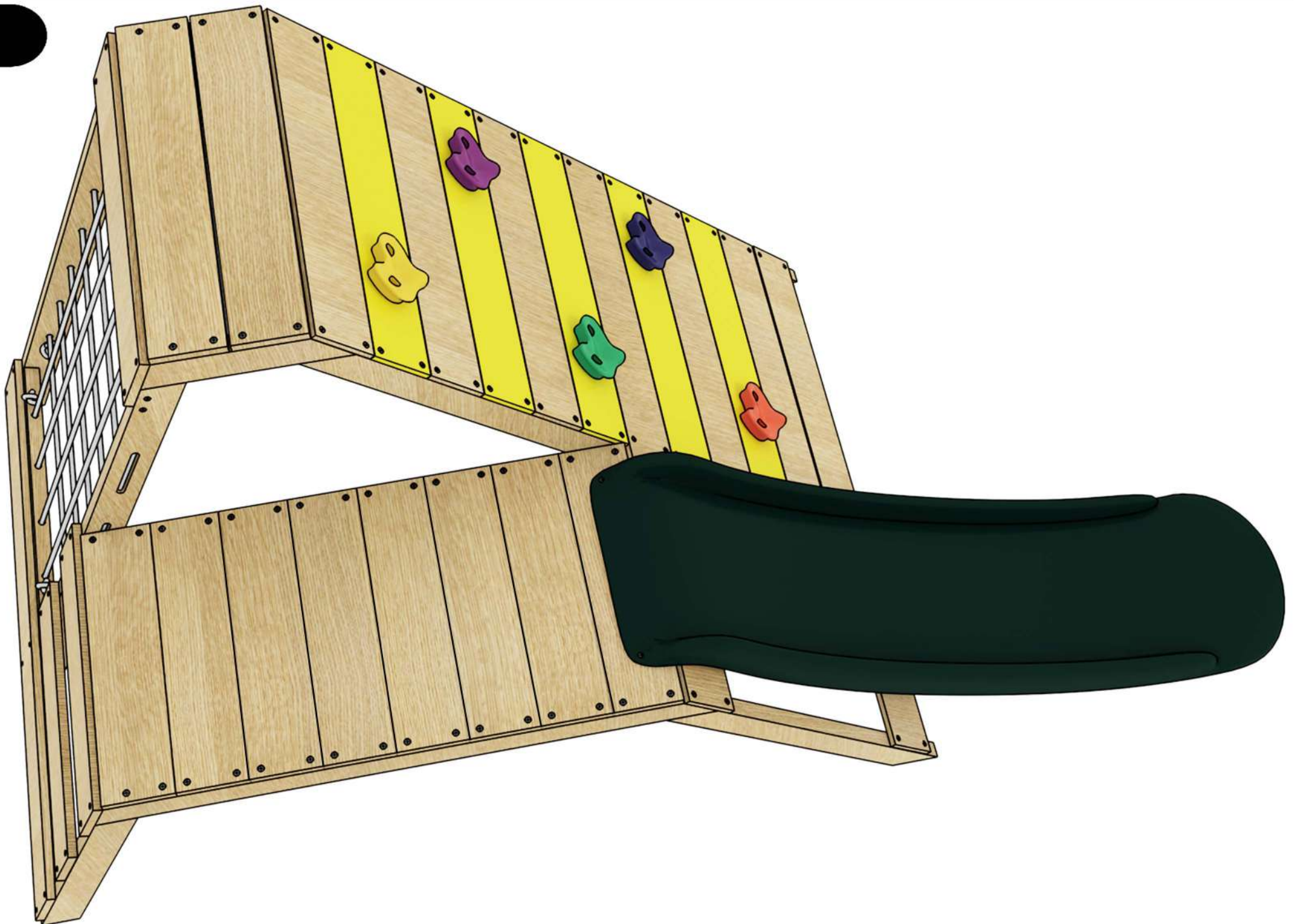

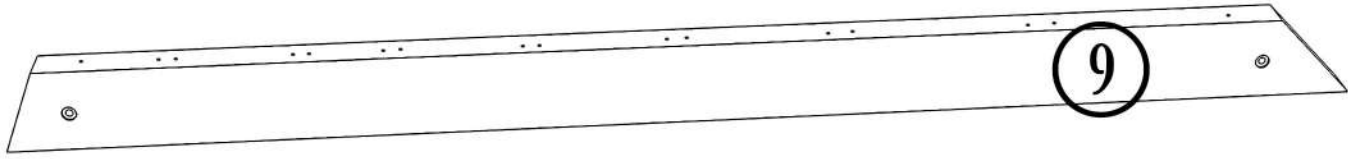

9

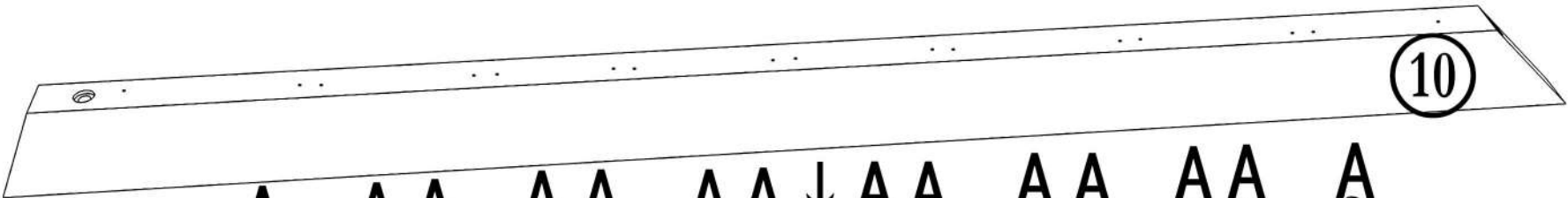

10

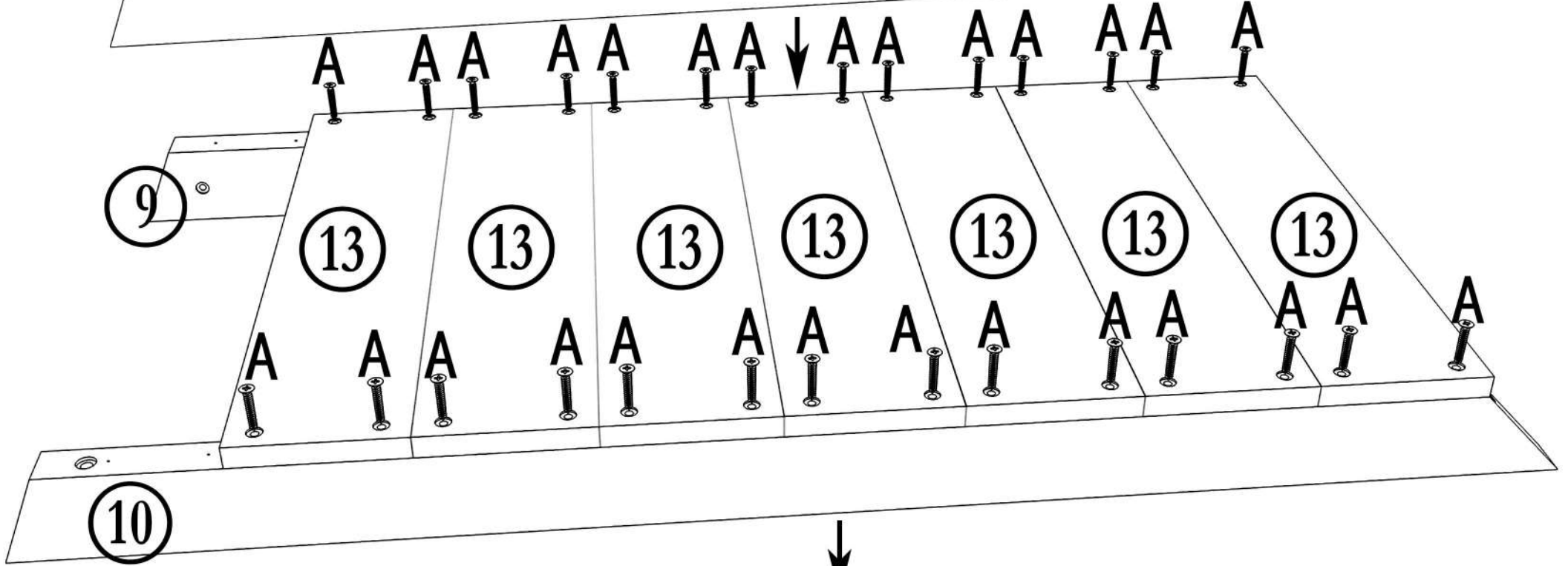

9

13

13

13

13

13

13

13

10

A		28
	M5 x 30	

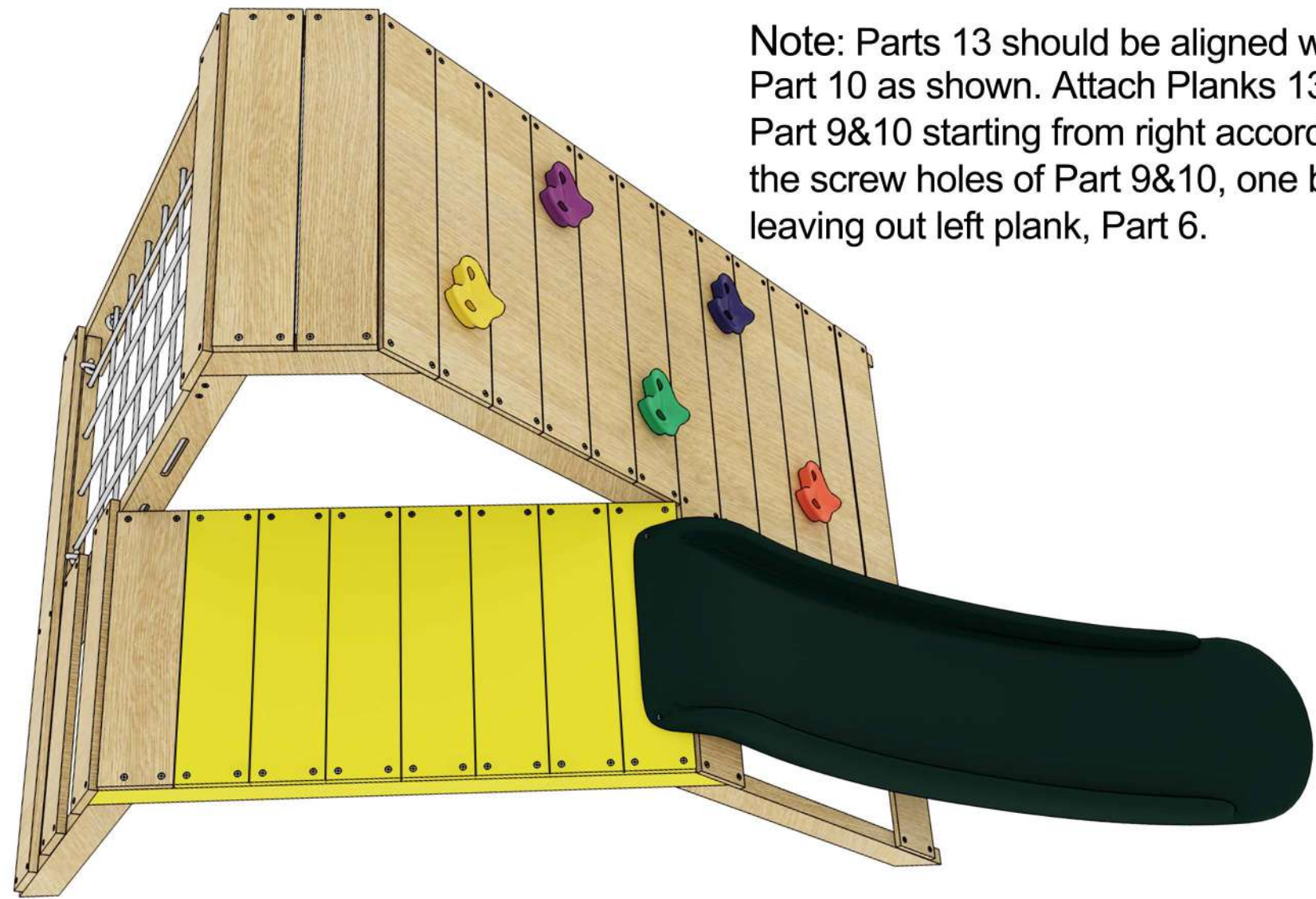
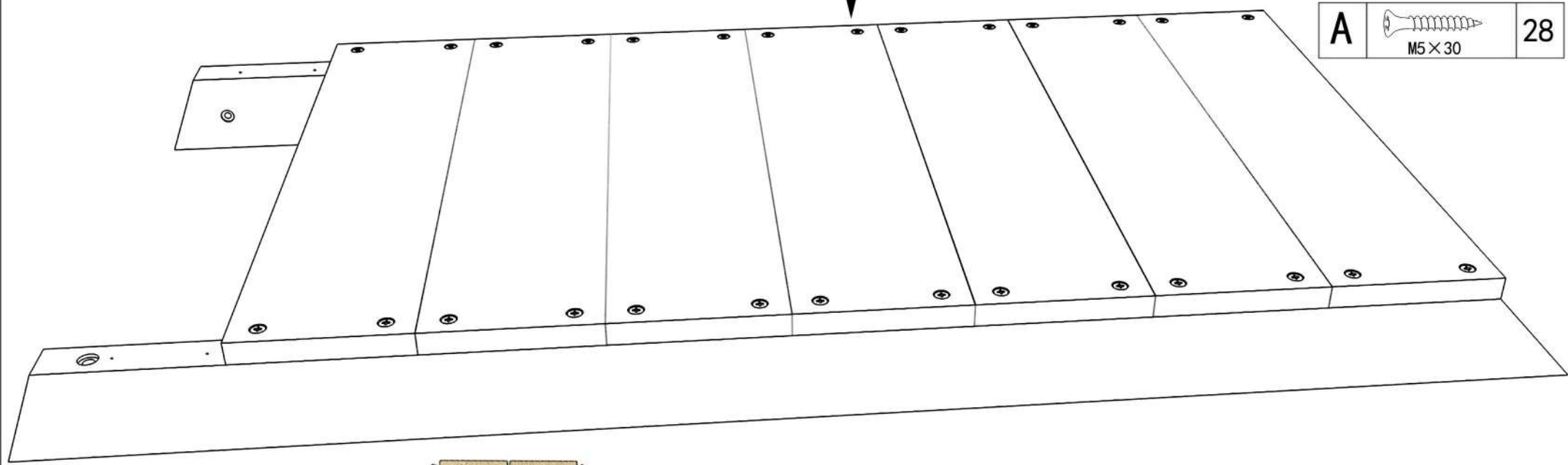

Note: Parts 13 should be aligned with Part 10 as shown. Attach Planks 13 to Part 9&10 starting from right according to the screw holes of Part 9&10, one by one, leaving out left plank, Part 6.

C2-1

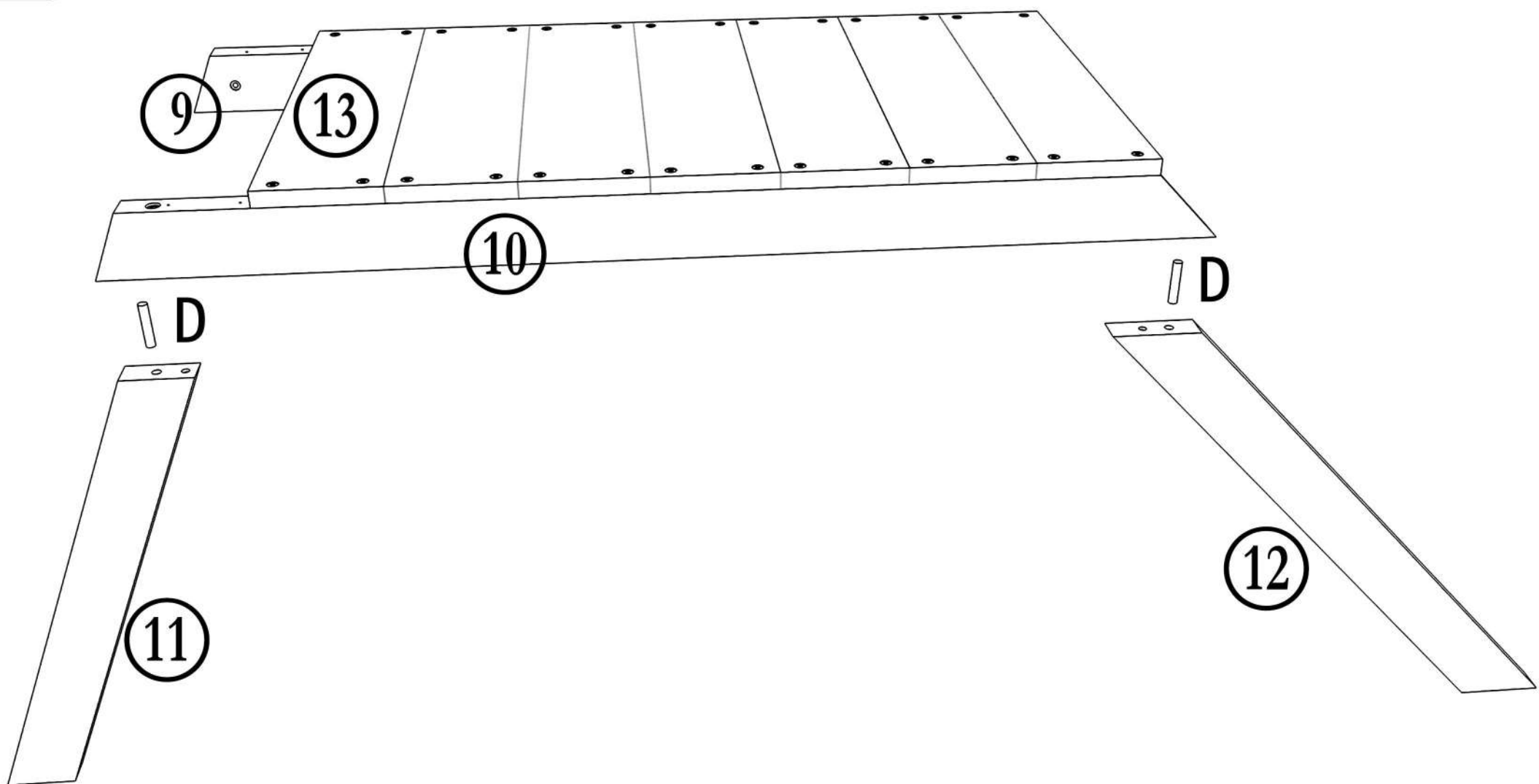

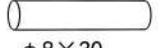

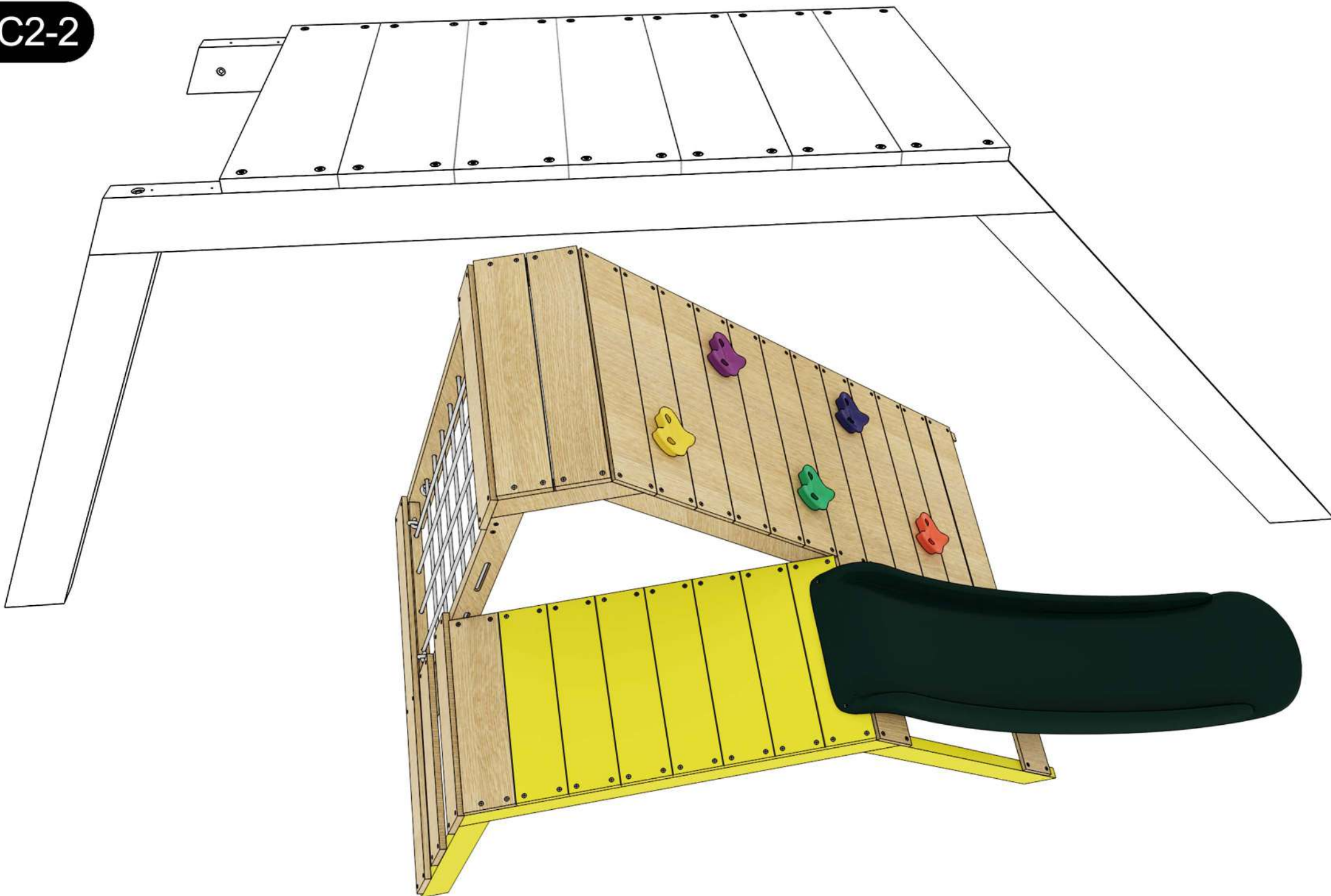

D		2
	$\phi 8 \times 30$	

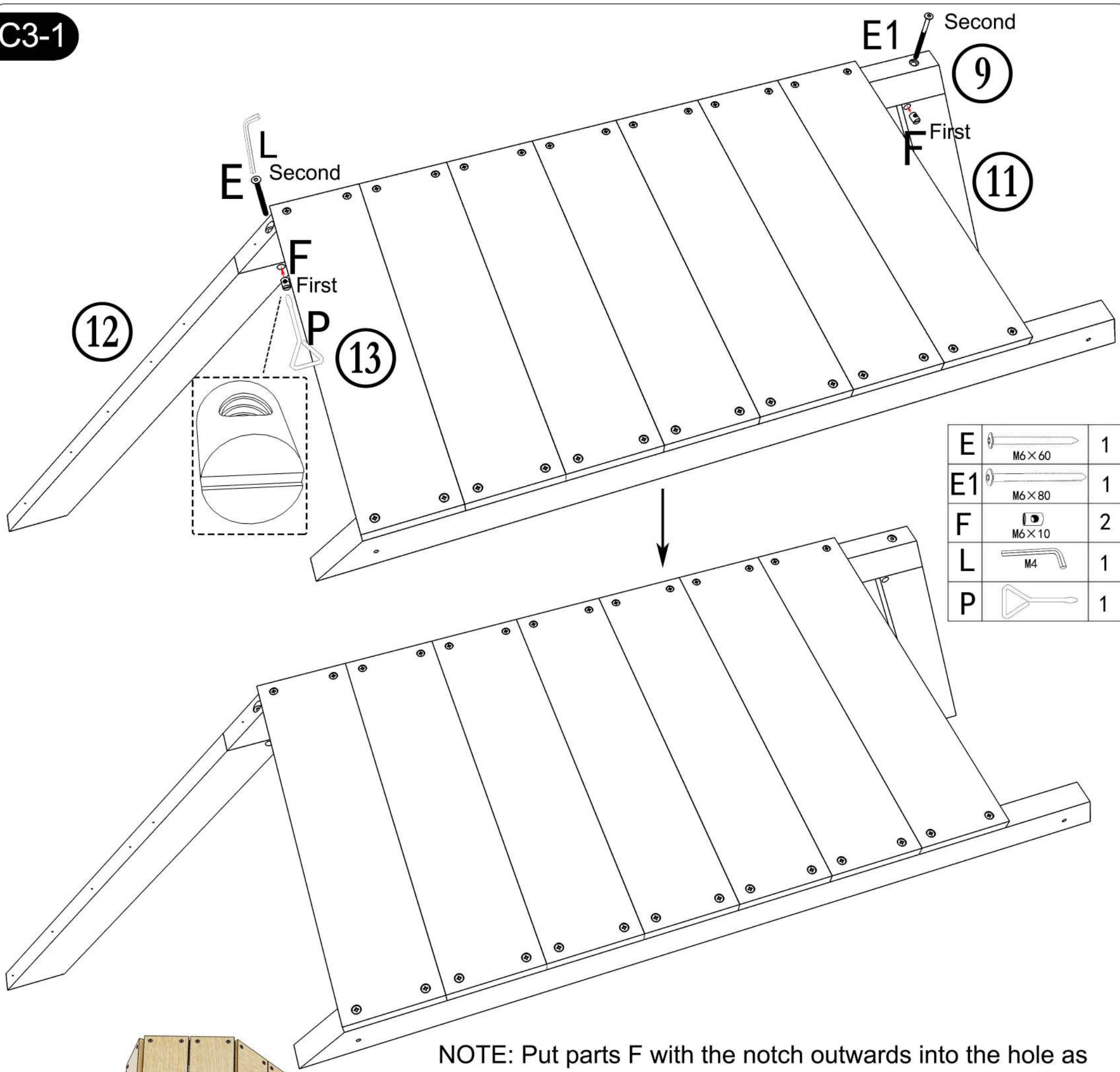
C2-2





E		M6×60	1
E1		M6×80	1
F		M6×10	2
L		M4	1
P			1

NOTE: Put parts F with the notch outwards into the hole as shown, insert part E & E1 into the corresponding hole, adjust part F with tool P, align the hole of F with screw E, and tighten screws E and E1 with tool L

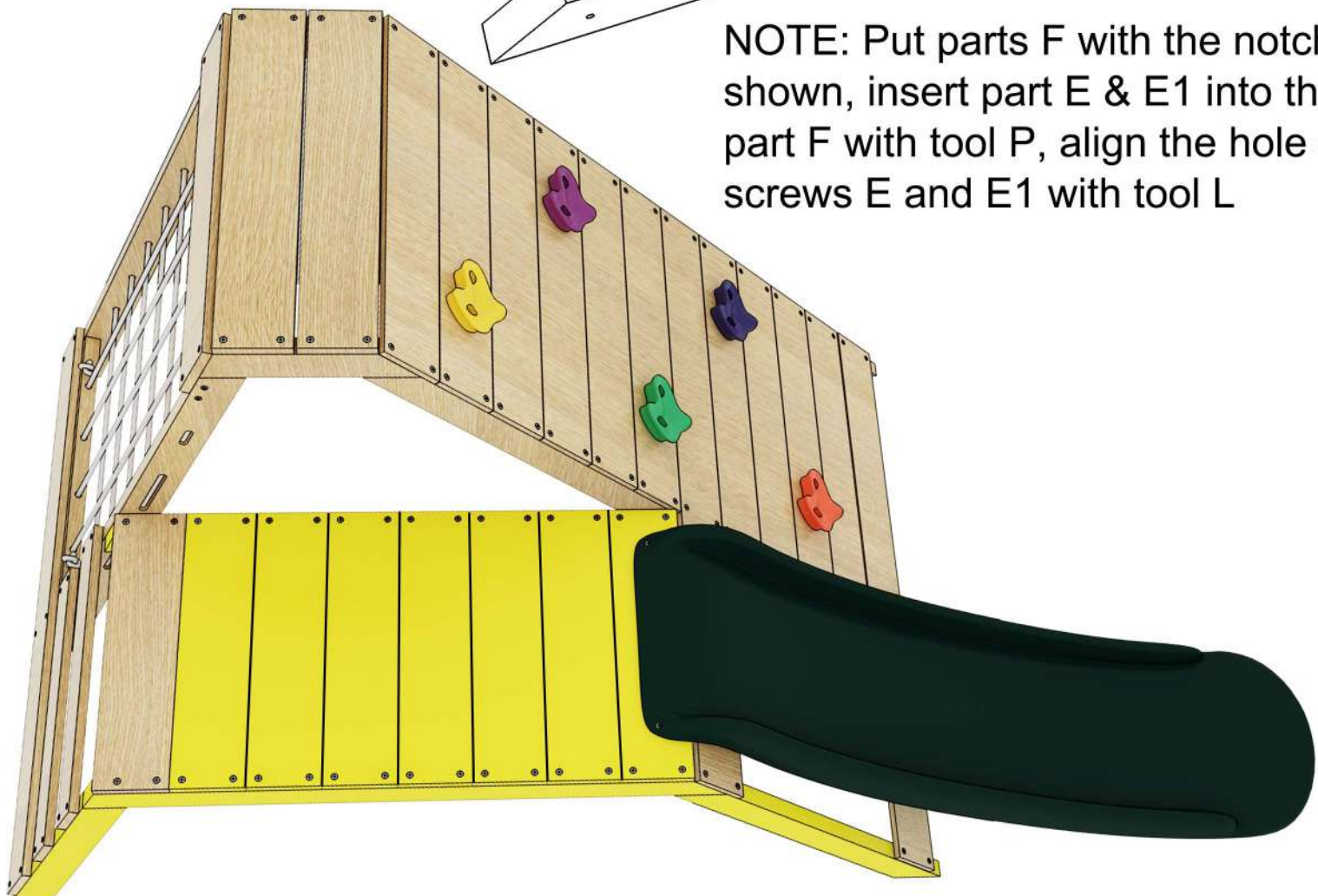

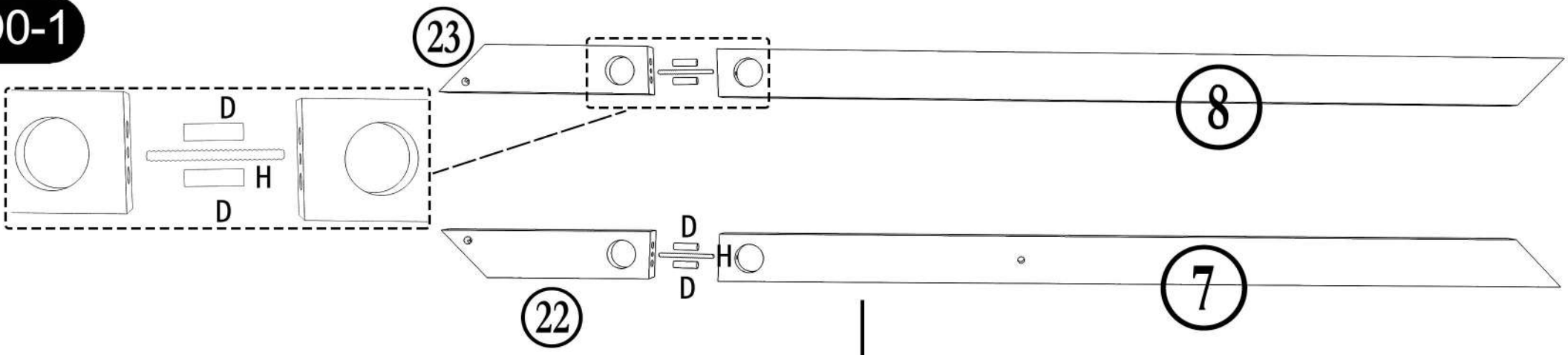

H	$\phi 6 \times 80$	2
D	$\phi 8 \times 30$	4

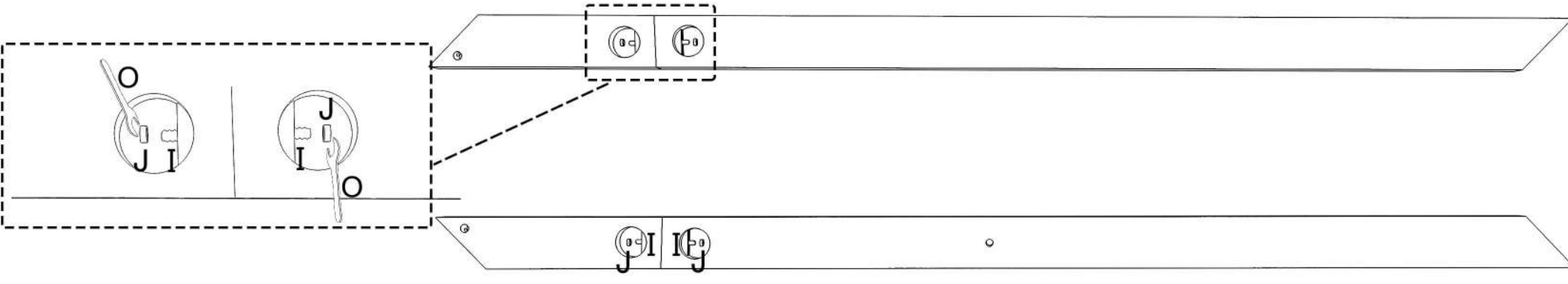
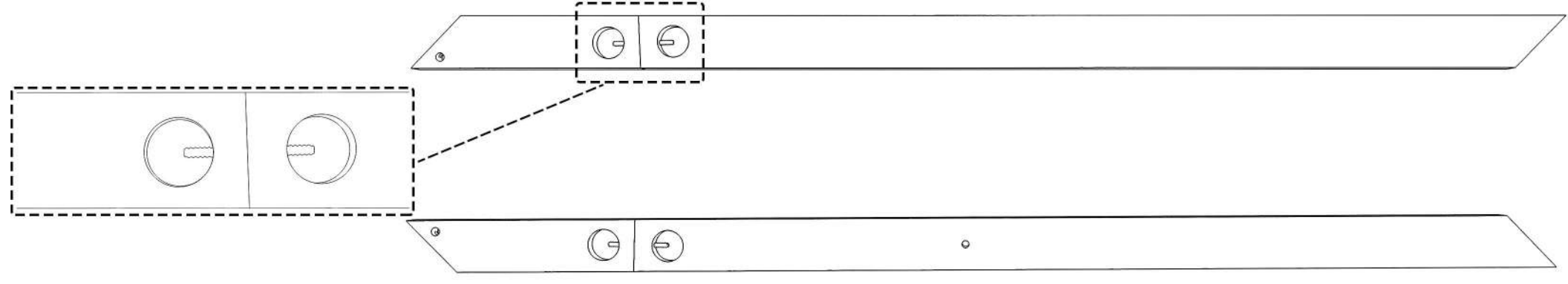

I		4
J	$M6 \times 10$	4
O	10mm	2

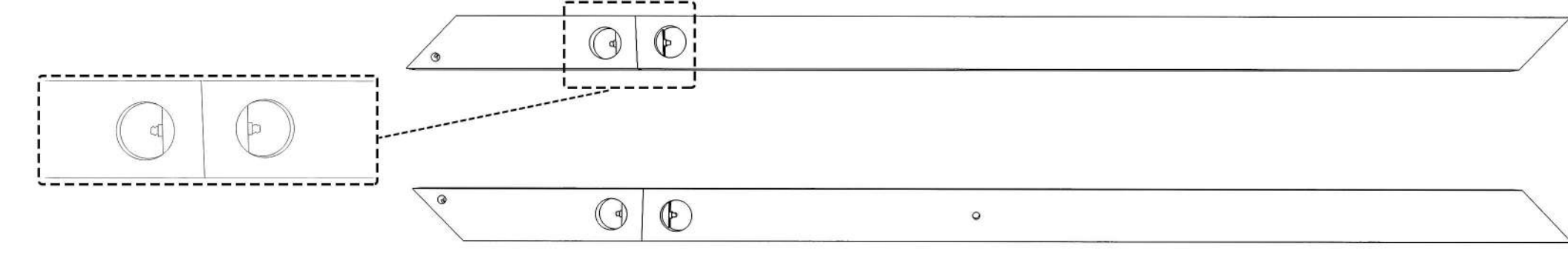



K φ40×5 4

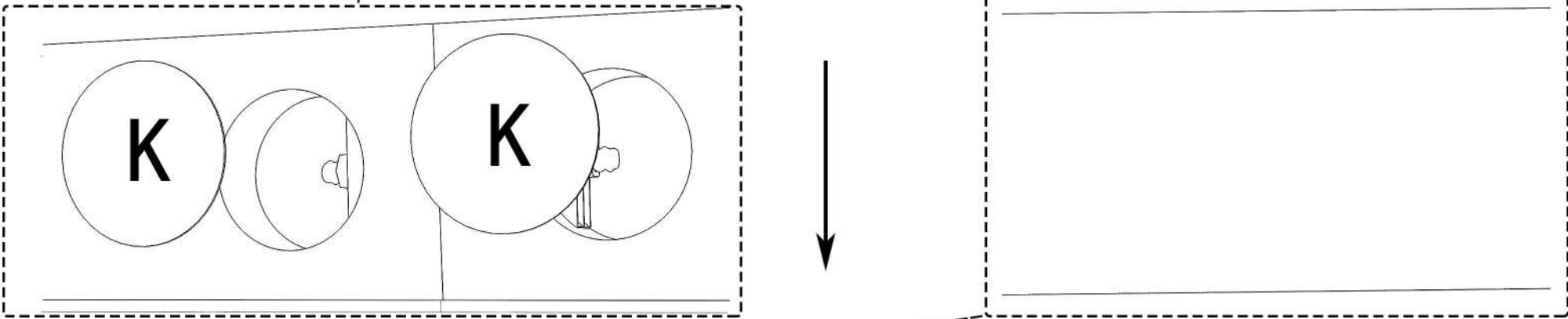
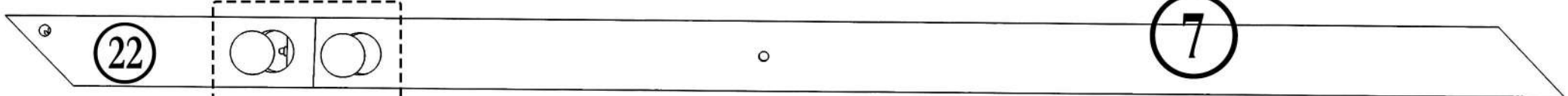

23 + 8

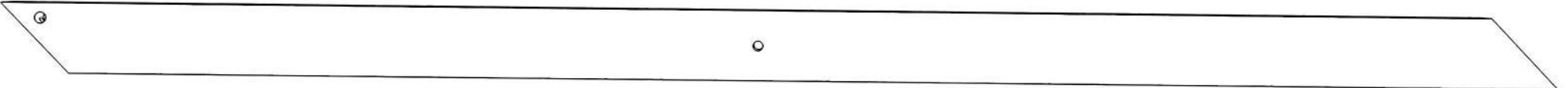

22 + 7

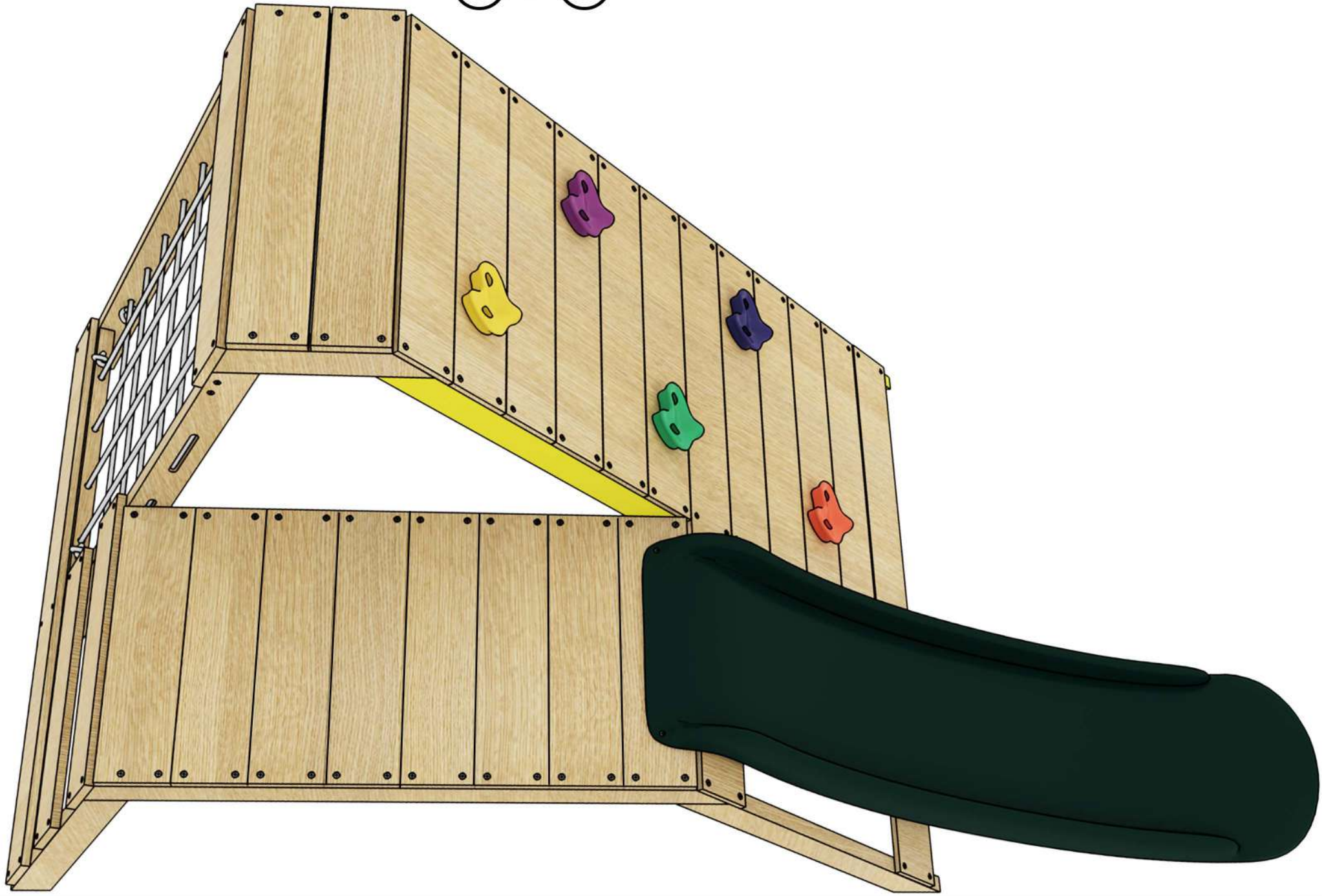

D1-1

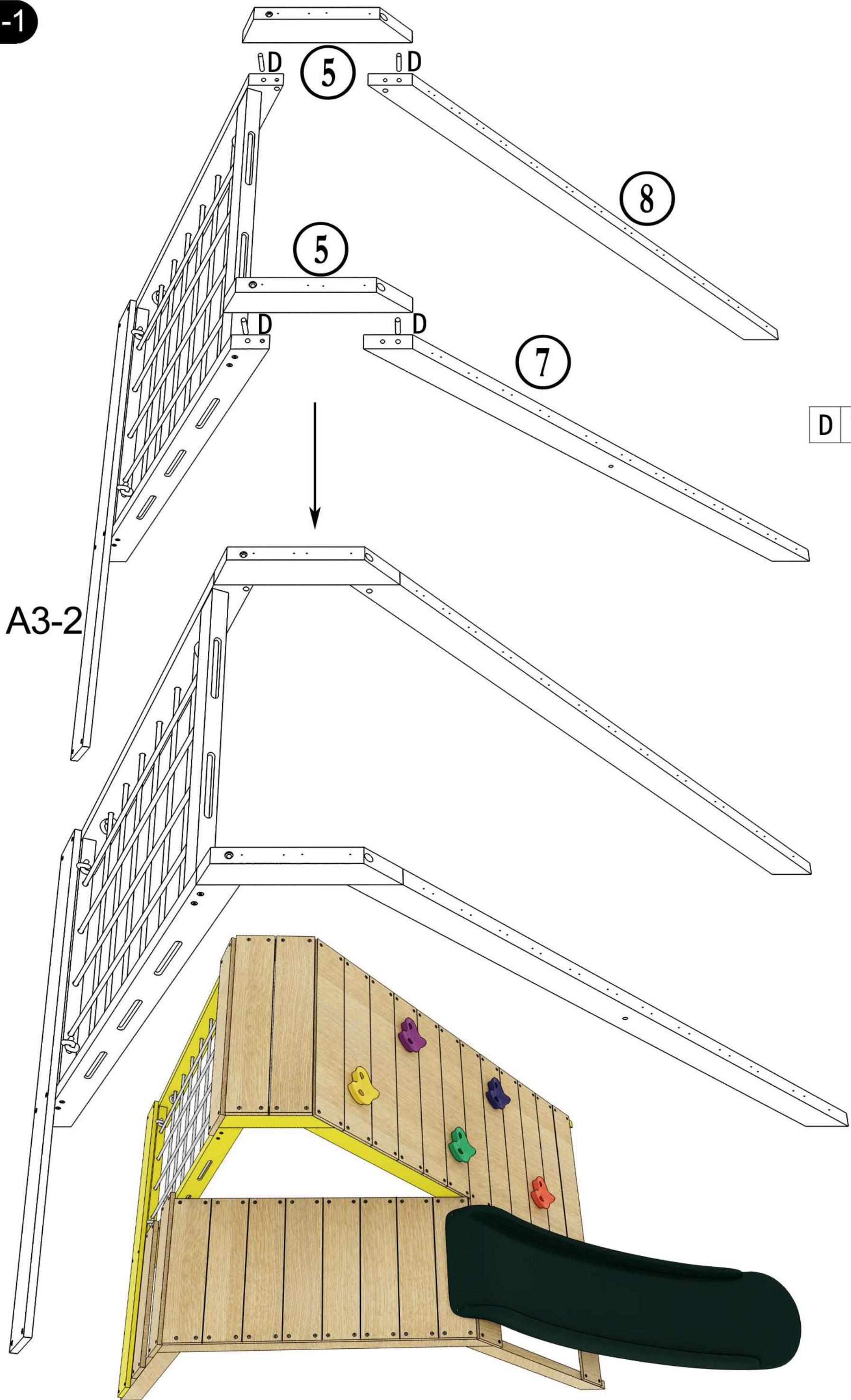





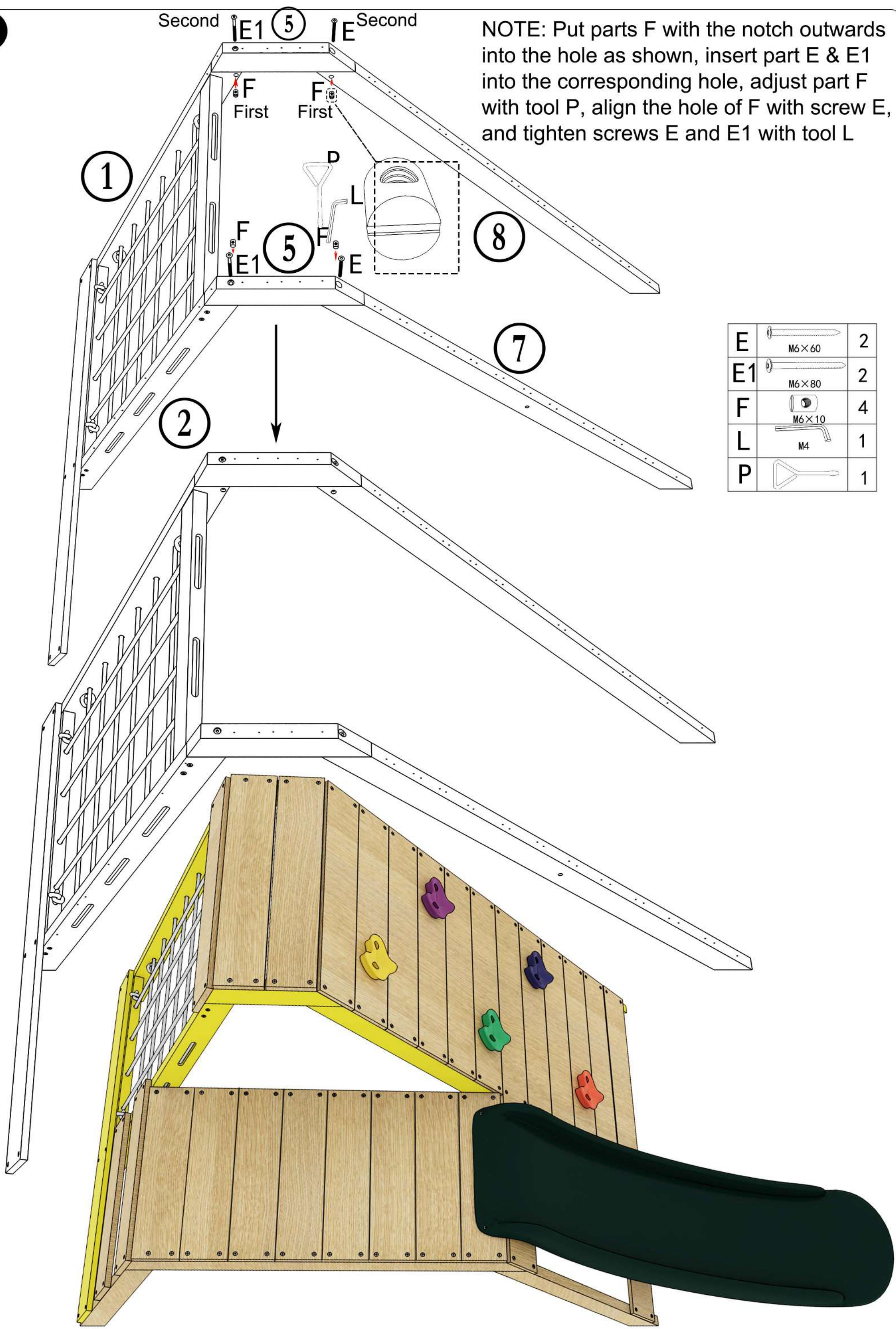

Second E1 5 E Second

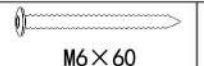
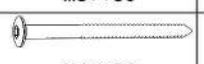
NOTE: Put parts F with the notch outwards into the hole as shown, insert part E & E1 into the corresponding hole, adjust part F with tool P, align the hole of F with screw E, and tighten screws E and E1 with tool L



E		2
E1		2
F		4
L		1
P		1

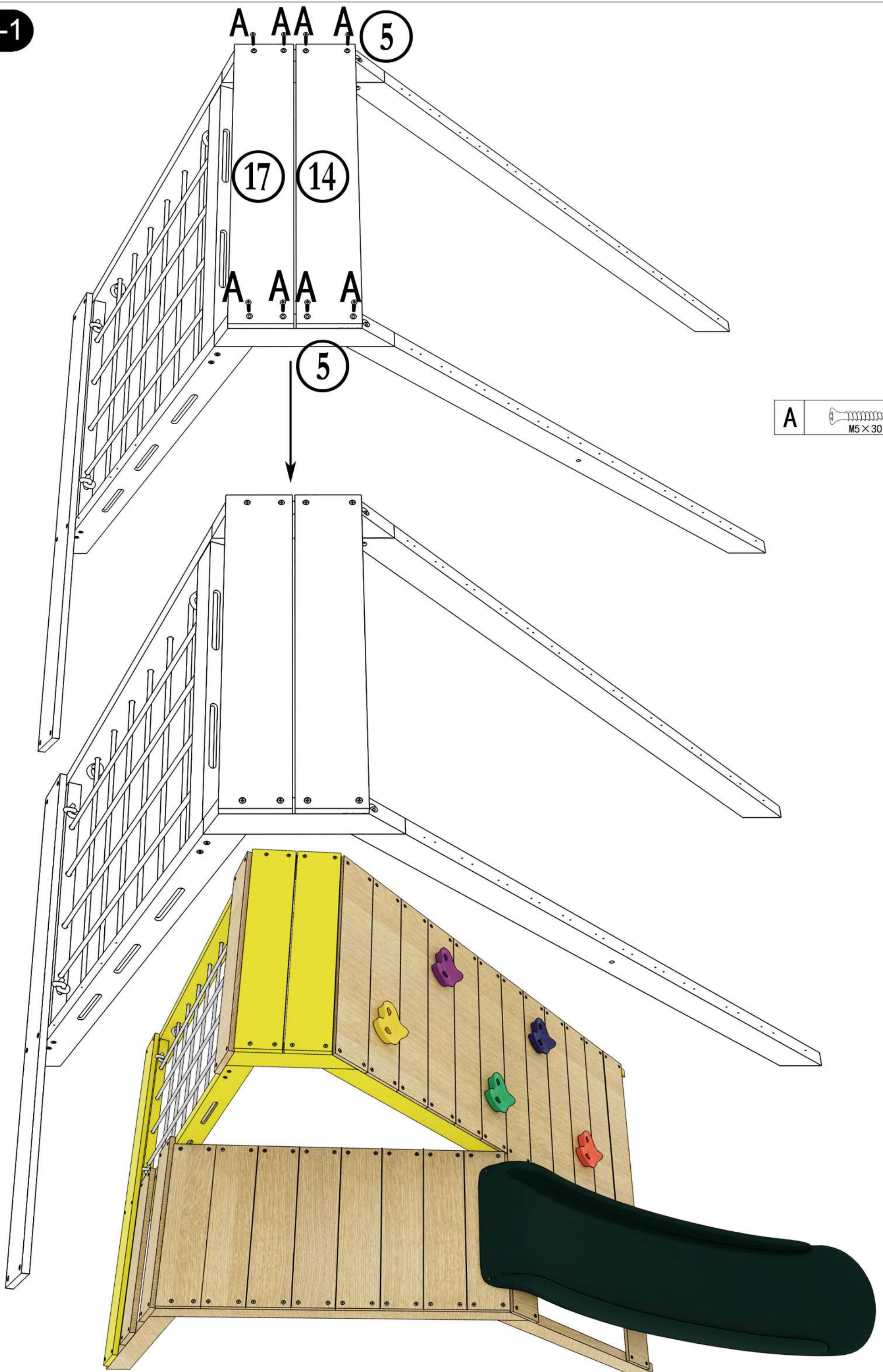

D3-1

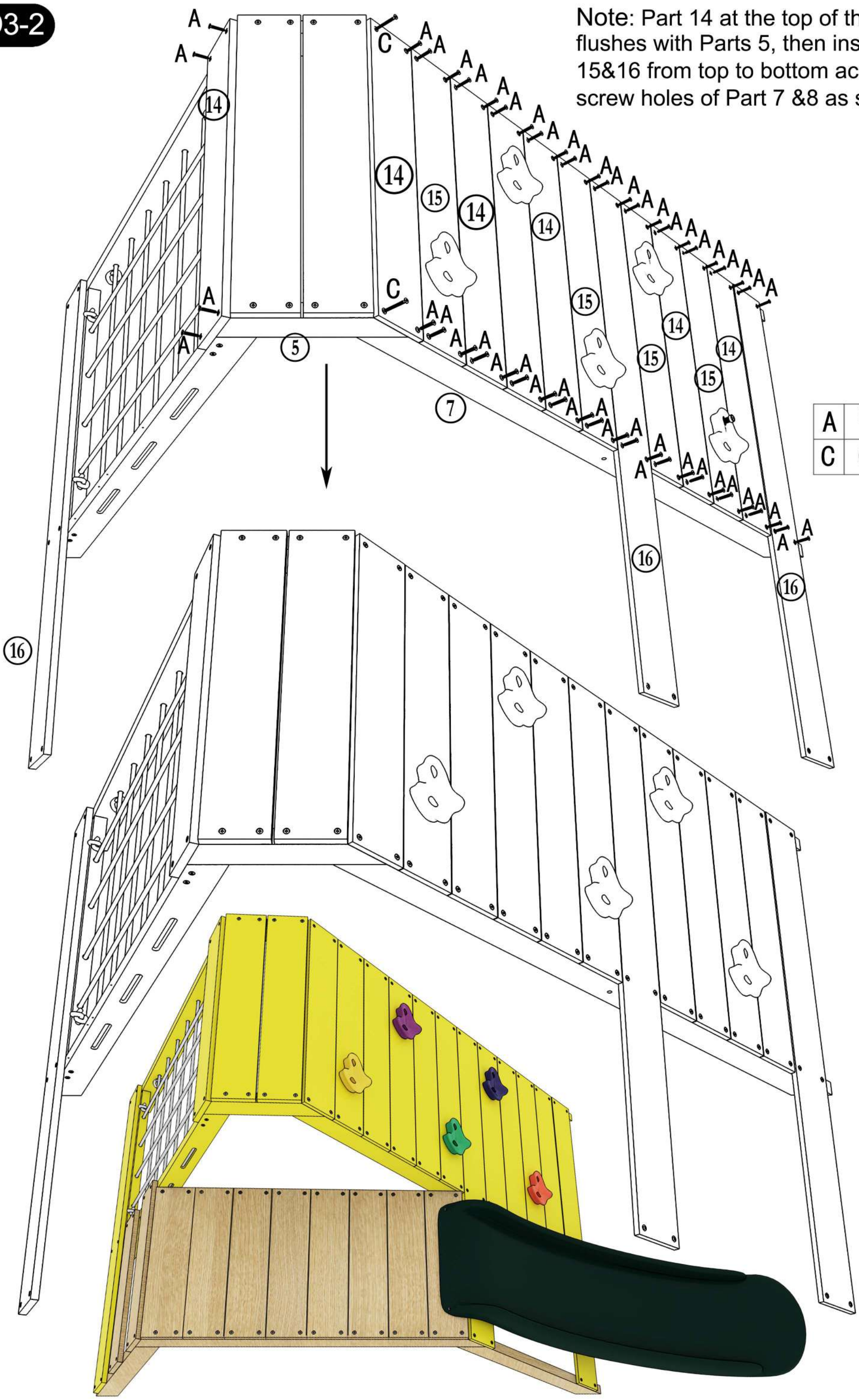

A	 M5 x 30	8
---	--	---

Note: Part 14 at the top of the right side flushes with Parts 5, then install Parts 14, 15&16 from top to bottom according to the screw holes of Part 7 &8 as shown.



A	 M5 x 30	50
C	 M5 x 50	2

D4-1

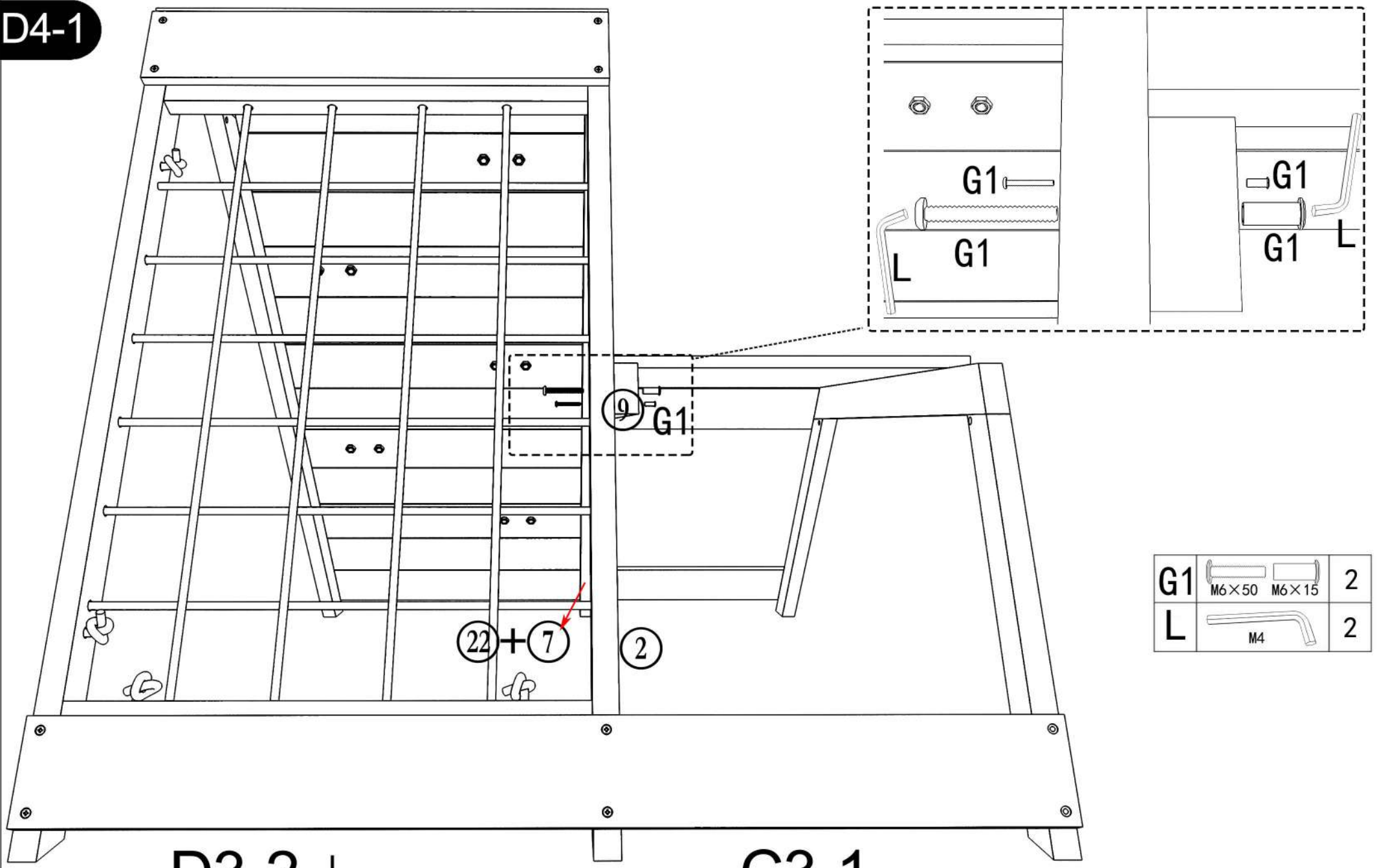

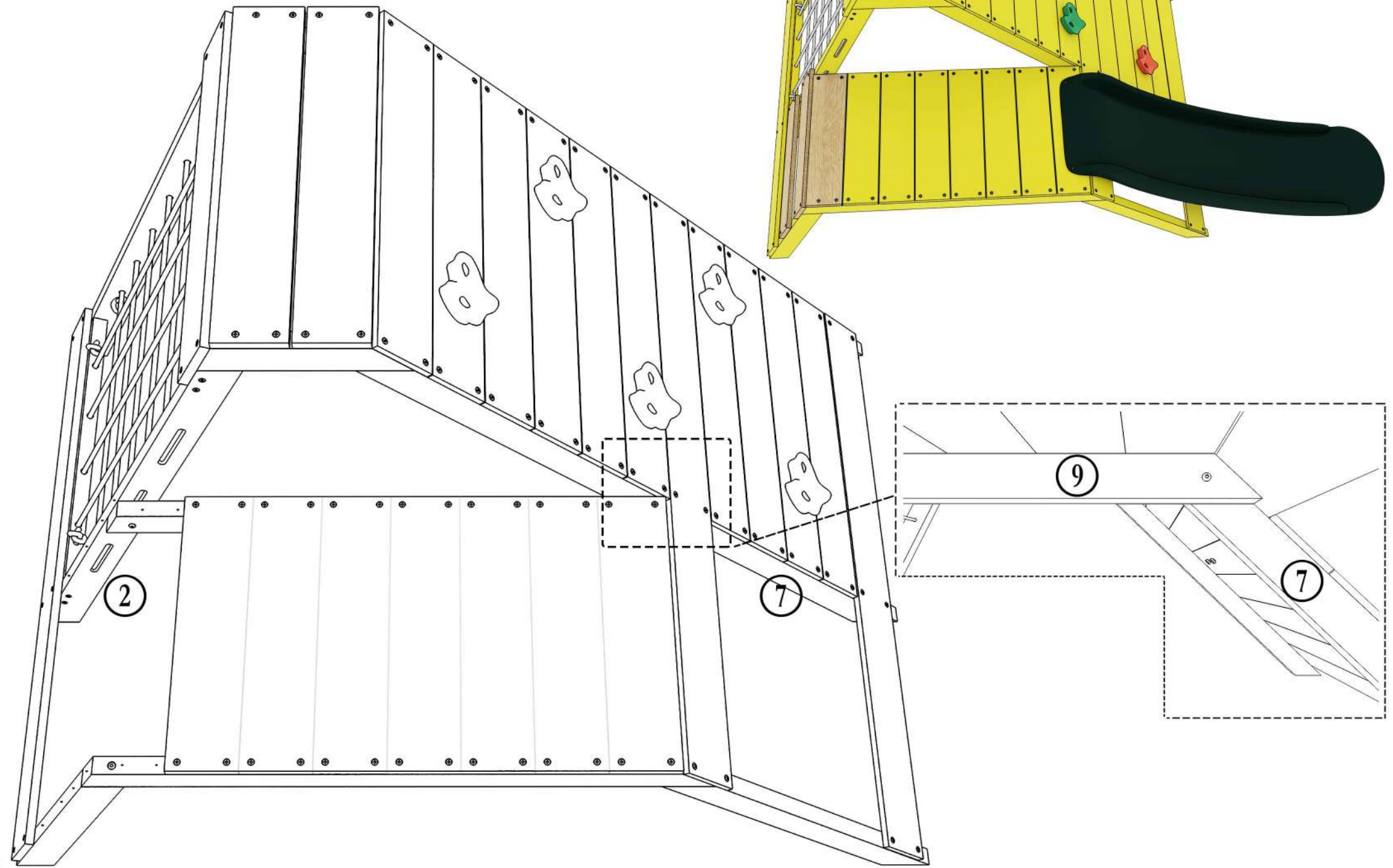

D3-2

C3-1

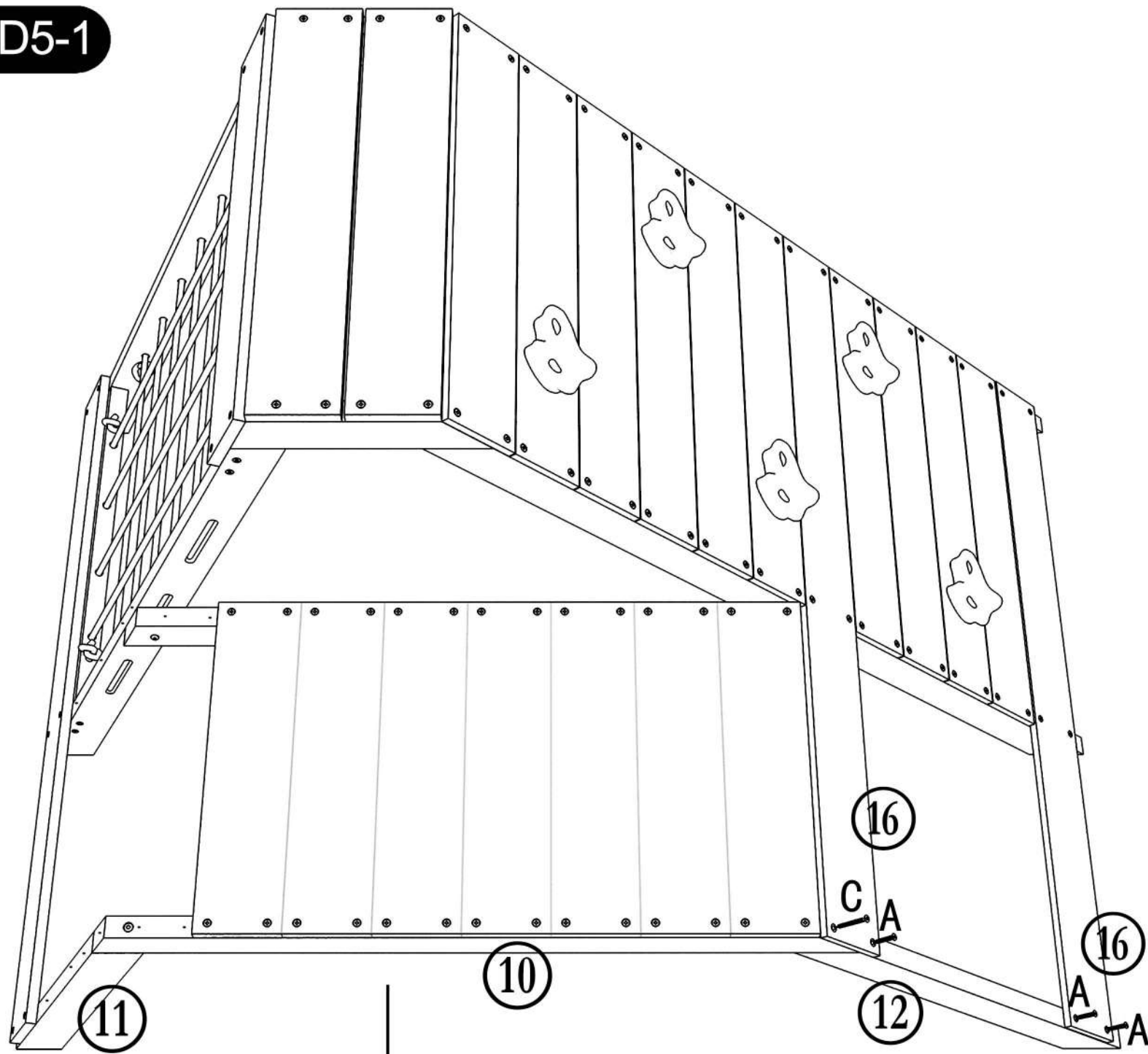

D5-1



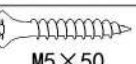

A	 M5 × 30	3
C	 M5 × 50	1

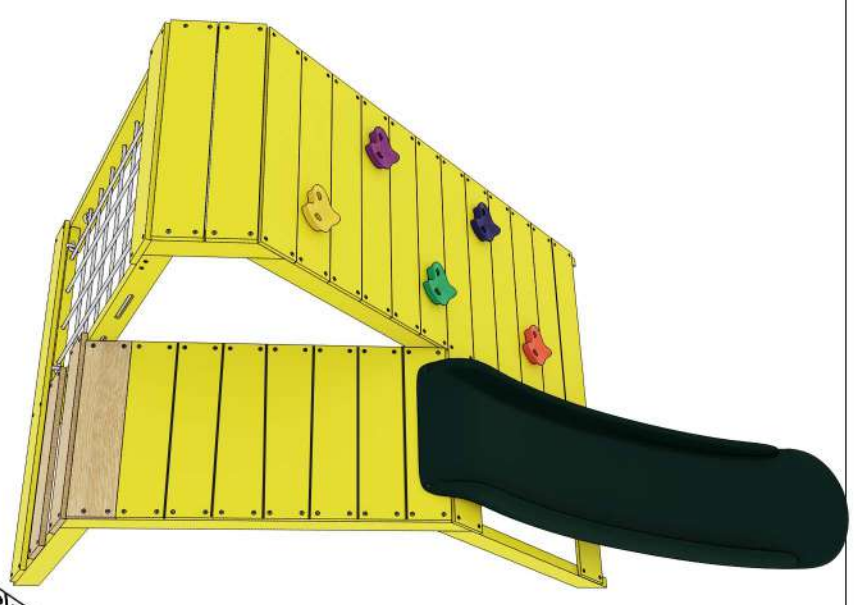
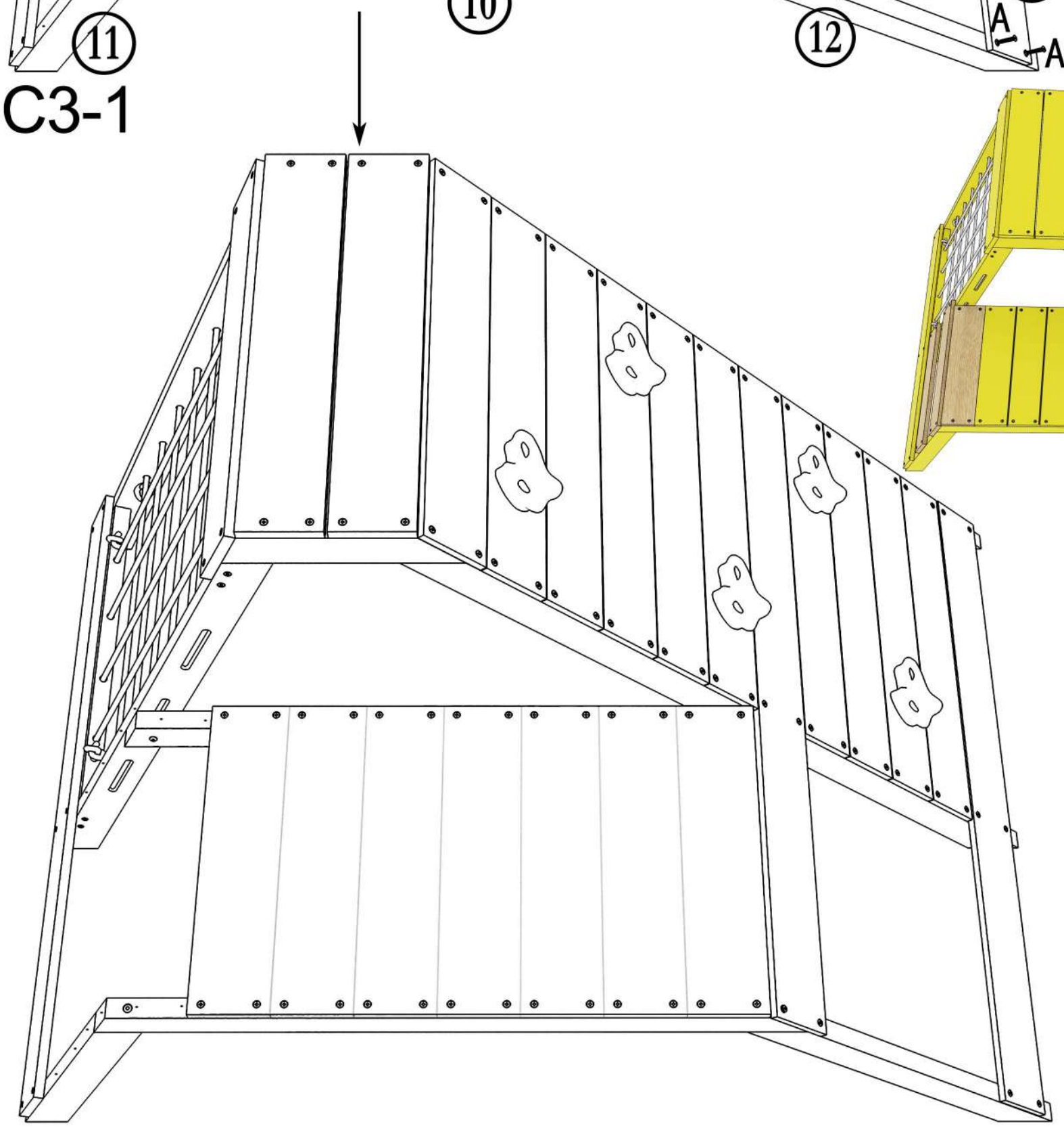
C3-1

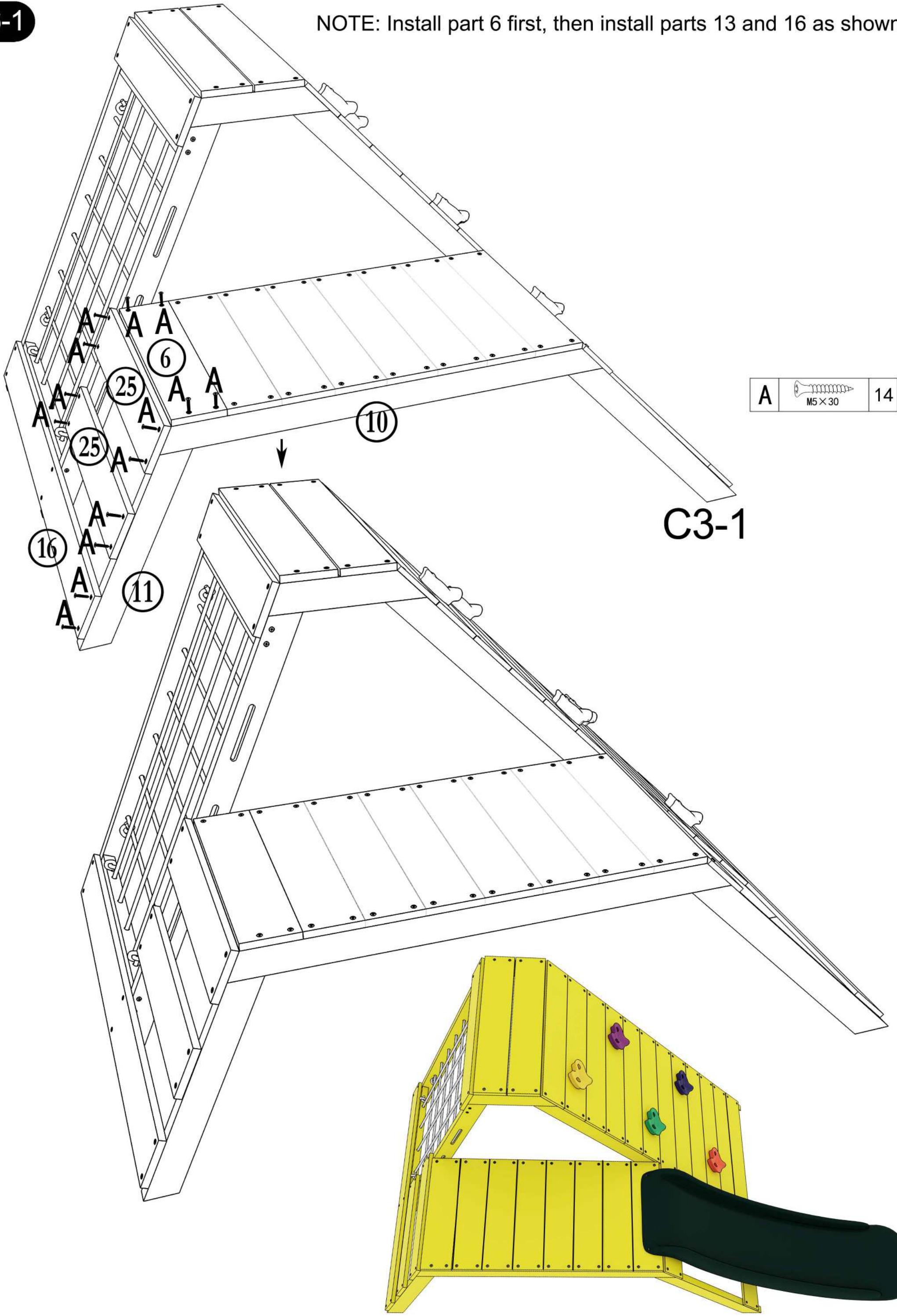

NOTE: Install part 6 first, then install parts 13 and 16 as shown



A	 M5 x 30	14
---	--	----

D7-1

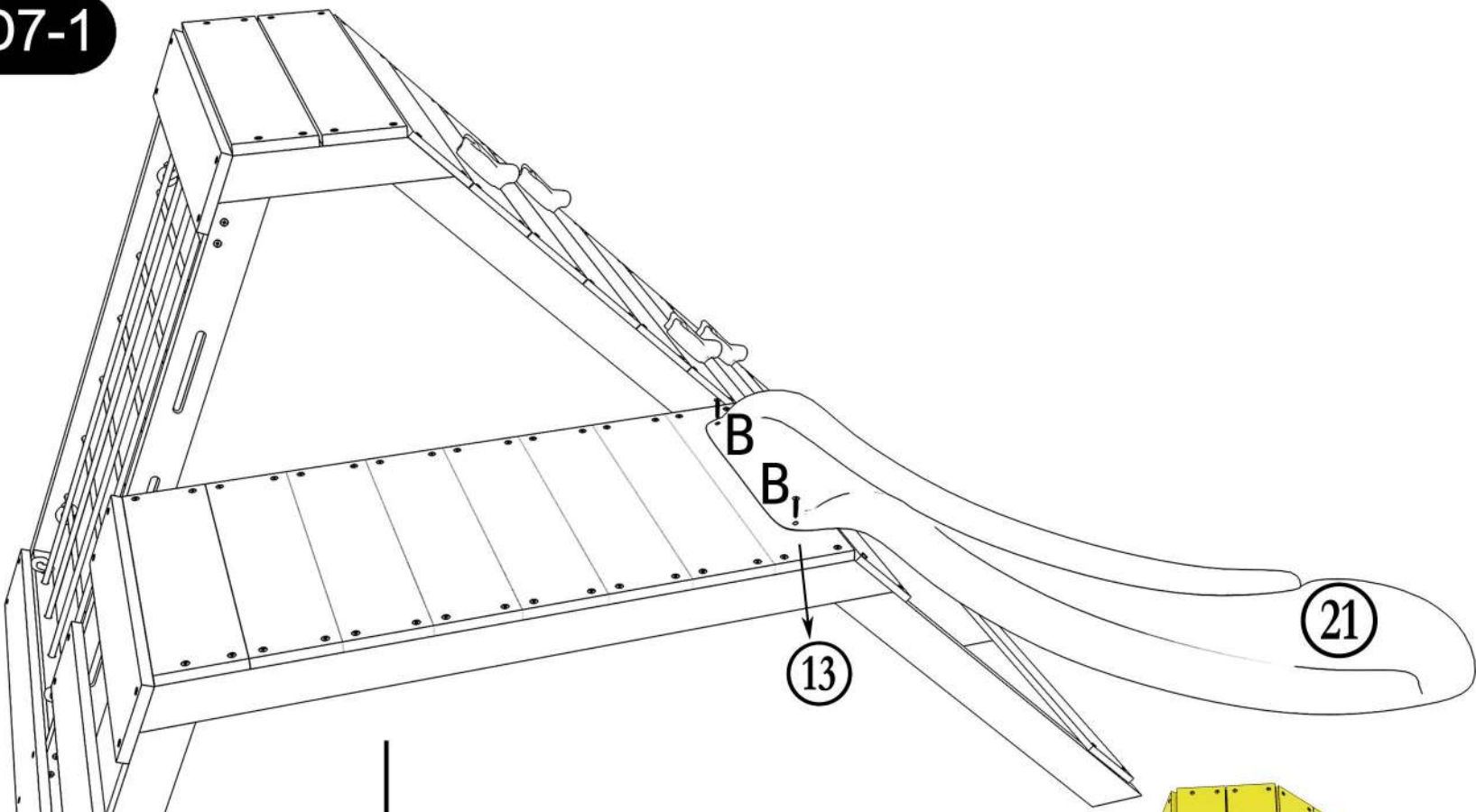

<b>B</b>	 M5×16	<b>2</b>
----------	--	----------

