

avenlur

Hawthorn by Avenlur

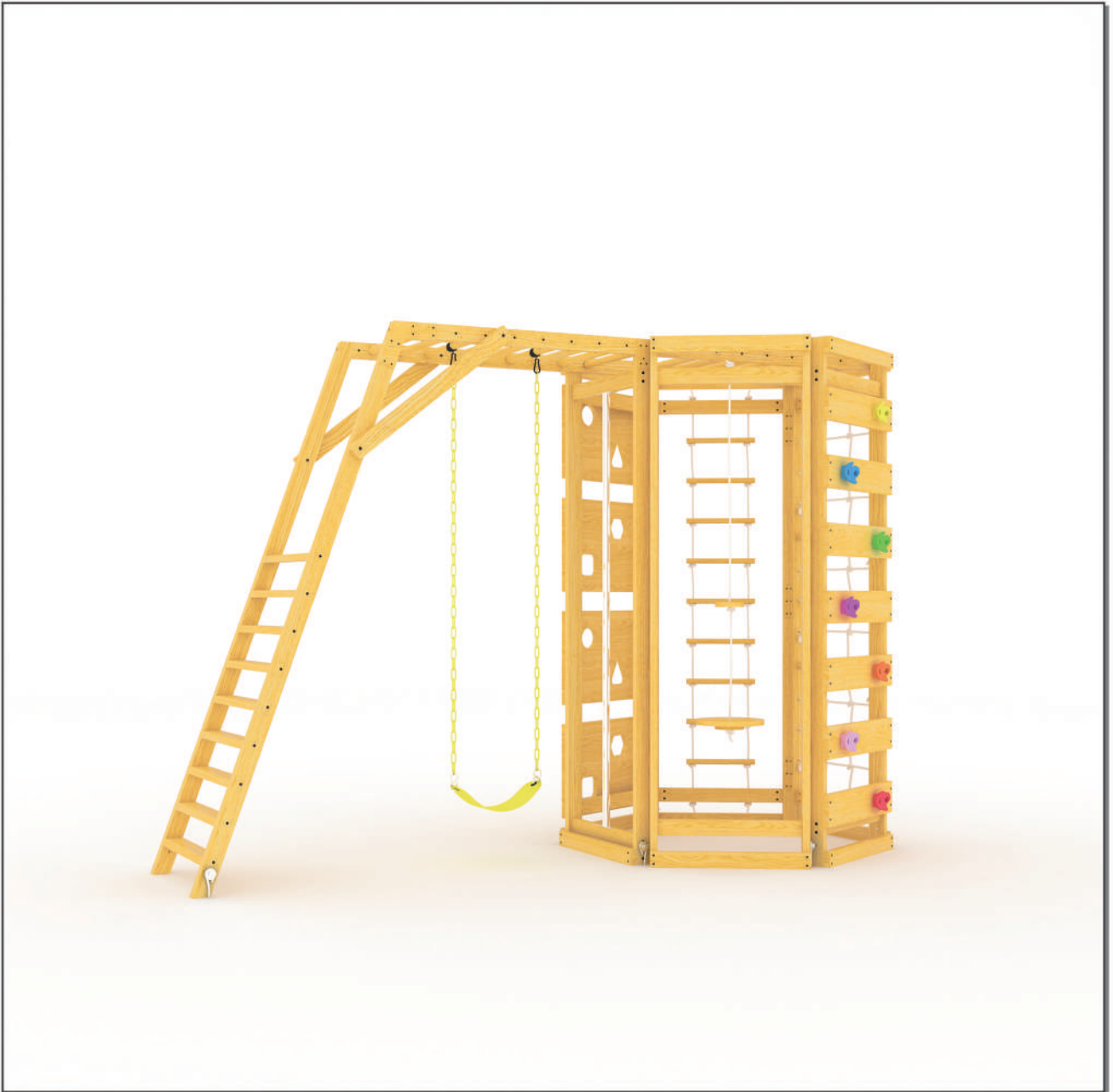

Need Help?

CALL US AT 888.697.3931 / M-F 9AM - 5PM PT (12PM - 8PM ET)
OR EMAIL US AT INFO@AVENLUR.COM

PLEASE READ THIS BEFORE STARTING ASSEMBLY

PLEASE RETAIN THESE INSTRUCTIONS FOR FUTURE REFERENCE. KEEP THEM IN A SAFE PLACE, WHERE YOU CAN REFER TO THEM AS NEEDED. IN ORDER TO PROVIDE YOU WITH THE MOST EFFICIENT SERVICE, IT IS REQUIRED THAT YOU PROVIDE US WITH THE PART NUMBERS WHEN ORDERING PARTS.

PLEASE HAVE THE FOLLOWING INFORMATION WHEN YOU MAKE YOUR CALL:

1-MODEL NAME OF THE PRODUCT LOCATED ON THE FRONT OF THE ASSEMBLY MANUAL

2-DESCRIPTION OF THE PART FROM THE PARTS LIST

3- CONTACT US AT: AVENLUR- 110 S.NEWMAN ST., HACKENSACK, NJ 07601, 888-697-3931

READ THE ASSEMBLY MANUAL COMPLETELY, PAYING SPECIAL ATTENTION TO THE IMPORTANT TIPS AND SAFETY INFORMATION. WE ADVISE OUR CUSTOMERS TO HIRE PROFESSIONAL HELP FOR INSTALLING THIS PLAYSET.

SEPARATE AND IDENTIFY ALL PARTS TO MAKE SURE THAT YOU HAVE ALL OF THE PARTS LISTED. IF YOU CAN'T FIND ALL OF THE PARTS, CHECK THE PACKING MATERIAL. SMALL PARTS MAY HAVE FALLEN OUT OF THE PACKET AND INTO THE MAIN BOX DURING TRANSIT.

PLEASE HAVE AN ELECTRIC SCREWDRIVER AVAILABLE FOR ASSEMBLY.

PLEASE NOTE: THE WOOD IS TREATED WITH ANTI CORROSIVE TREATMENT WHICH MAY RESULT IN VERY SMALL CRACKS OR ROUGH SURFACES IN AREAS. THIS IS VERY NORMAL AND STANDARD. THIS WILL NOT AFFECT THE SAFETY AND STABILITY OF THE WOOD AND THE SWINGSET.

Equipment is recommended for use by **ages 3 and older**. **Children ages 1-3 may use the baby swing, which can be purchased separately**. Structures are **not intended for public use**. **Avenlur does not warranty any of its residential structures subjected to commercial use such as: Daycare, Preschool, Nursery School, Recreational Park, or any similar Commercial Application.**

Please follow all recommendations below. **Failure to do so may result in the warranty being void and/or safety violations that could result in serious injury**. This manual contains helpful information concerning Assembly Preparation, Installation Procedure, and Required Maintenance. Always keep the safety of your children in mind as your play structure is being built and as your children play on the set. Before your children play on the set please review the Operation Instructions with them to help ensure their safety.

WARNING:

Children must NOT use this playcenter until unit has been completely assembled and inspected by an adult to insure set has been properly installed and anchored.

WARNING:

This Symbol points out important safety instructions which, if not followed, could endanger the personal safety of yourself and your children and/or damage your property. You **MUST** read and follow all instructions in this manual before attempting to use this playcenter.

WARNING:

CONTINUOUS ADULT SUPERVISION REQUIRED!

WARNING:

STRANGULATION HAZARDS

1. Never allow children to play with ropes, clotheslines, pet leashes, cables, chains or cord-like items when using this playcenter or to attach items to playcenter.
2. Never allow children to wear loose fitting clothing, ponchos, hoods, scarves, capes, necklaces or items with draw-strings, cords or ties when using this playcenter.
3. Never allow children to wear bike or sport helmets when using this playcenter.
4. Failure to prohibit these items increases the risk of serious injury and death to children from entanglement and strangulation.

WARNING:

SERIOUS HEAD INJURY HAZARD

Maintain shock absorbing materials under and around playcenter as recommended in the installation & operation instructions, installation over concrete, asphalt, dirt grass, carpet and other hard surfaces creates a risk of serious injury or death from falls to the ground.

Positioning Your Playcenter

1. The playcenter is designed to be installed on a level surface by an Adult with an Adult helper. Place in a flat area of your yard to minimize ground preparation.
2. Choose a leveled location for the equipment, this can reduce the likelihood of the play set tipping over and loose-fill surfacing material washing away during heavy rains.
3. Place the equipment not less than **6 ft (1.8 m)** from any structure or obstruction such as a fence, garage, house, overhanging branches, laundry lines, or electrical wires.
4. Provide enough room so that the children can use the equipment safely. For example, for structures with multiple play activities, a slide should not exit in front of a swing.
5. It is a good idea to place your playcenter in an area that is convenient for adults to watch children at play.
6. Create a site free of obstacles that could cause injuries- such as low overhanging tree branches, overhead wires, tree stumps and/or roots, large rocks, bricks and concrete. Additional suggestions in the Suggested Playground Surfacing Section.

Suggested Playground Surfacing

1. Do not install home playground equipment over concrete, asphalt, packed earth, artificial grass, or any other hard surface. A fall onto a hard surface can result in serious injury to the equipment user.
2. Do not install loose fill surfacing over hard surfaces such as concrete or asphalt. Shredded bark mulch, wood chips, fine sand and fine gravel, are added as shock absorbing materials after assembly. If used properly these materials can absorb some of the impact of a child's fall.
3. All surface material should extend a minimum of 6 feet in all directions around the play area.
4. Do not apply playground surfacing until after the unit is completely constructed. Playcenter should not be built on top of surfacing.
5. Use containment, such as digging out around the perimeter and/or lining the perimeter with landscape edging.
6. Installations of rubber tiles or poured-in-place surfaces (other than loose-fill materials) generally require a professional and are not "do-it-yourself" projects.
7. Use Playground Surfacing Materials (other than loose-fill materials) which comply with the safety standard ASTM F1292 Standard Specification of Impact Attenuation of Surfacing Materials within the Use Zone of Playground Equipment.

Operating Instructions:

NOTE: Your children's safety is our No.1 concern.

Observing the following statements and warnings reduces the likelihood of serious or fatal injury. Please review these safety rules regularly with your children.

1. On-site adult supervision is required.
2. Instruct children not to walk close to, in front of, behind, or between moving swings or other moving playground equipment.
3. Instruct children to sit in and never stand on swings.
4. Instruct children not to twist the chains and ropes and not to loop them over the top support bar, since this may reduce the strength of the chain or rope.
5. Instruct children not to jump from swings or other playground equipment in motion.
6. Instruct children to not to push empty seats. The seat may hit them and cause serious injury.
7. Instruct and teach children to sit in the center of the swings with their full weight on the seats.
8. Instruct children not to use the equipment in a manner other than intended.
9. Instruct children to always go down slides feet first. Never slide head first.
10. Instruct children to look before they slide to make sure no one is at the bottom.
11. Instruct children to never run up a slide, as this increases their chances of falling.
12. The parents should dress children appropriately. (Examples would include the use of well-fitting shoes and the avoidance of ponchos, scarfs, and other loose-fitting clothing that is potentially hazardous while using equipment).

13. Instruct children not to climb when the equipment is wet.
14. Instruct children to never jump from high areas. They should always use the ladder, ramp or slide.
15. Instruct children to never crawl on top of the roof.
16. Verify that any suspended climbing ropes, chain, or cable are secured at both ends and that they cannot be looped back on it.
17. Instruct children not to attach items to the playground equipment that are not specifically designed for use with the equipment, such as, but not limited to, jump ropes, clothes line, pet leashes, cables and chain as they may cause a strangulation hazard.
18. Instruct children to never wrap their legs around swing chain. Instruct children to never slide down the swing chain. Instruct children to remove their bike or other sports helmet before playing on playground equipment.

Maintenance Instructions:

At the beginning of each play season:

1. Tighten all hardware.
2. Lubricate all metallic moving parts per manufacturer's instructions.
3. Check all protective coverings on bolts, pipes, edges and corners. Replace if they are loose, cracked, or missing.
4. Check all moving parts including swing seats, ropes, cables, and chains for wear, rust, or other deterioration. Replace as needed.
5. Check metal parts for rust. If found, sand and repaint using a non Lead-based paint meeting the requirements of 16 CFR 1303.
6. Check all wood members for deterioration and splinters. Sand down splinters and replace deteriorating wood members.
7. Reinstall any plastic parts, such as swing seats or any other items that were removed for the cold season.
8. Rake and check depth of loose fill protective surfacing materials to prevent compaction and to maintain appropriate depth. Replace as necessary.

Twice a month during play season:

1. Tighten all hardware.
2. Check all protective coverings on bolts, pipes, edges and corners. Replace if they are loose, cracked, or missing.
3. Rake and check depth of loose fill protective surfacing materials to prevent compaction and to maintain appropriate depth. Replace as necessary.

Once a month during play season:

1. Lubricate all metallic moving parts per manufacturer's instructions.
2. Check all moving parts including swing seats, ropes, cables, and chains for wear, rust, or other deterioration. Replace as needed.

At the end of each play season or when the temperature drops below 32° F:

1. Remove plastic swing seats and other items as specified by the manufacturer and take indoors or do not use.
2. Rake and check depth of loose fill protective surfacing materials to prevent compaction and to maintain appropriate depth. Replace as necessary.

Last but not least:

Varnish paint by nature will fade when outdoors within 1-2 years due to exposure to sunlight and the elements. You may purchase outdoor varnish paint and apply a new coating every few years to keep the varnish color fresh.

Additional Maintenance:

1. Check the swing beam and hardware every two weeks due to wood expansion and contraction. It is particularly important that this procedure be followed at the beginning of each season.
2. Inspect wood parts monthly. The grain of the wood sometimes will lift in the dry season causing splinters to appear. Light sand may be necessary to maintain a safe playing environment. Treat your playcenter with stain regularly, to help prevent severe checking/splitting and other weather damage.
3. A waterborne transparent stain has been applied to your playcenter. This is done for color only. Once or twice a year, depending on your climate conditions, you must apply some type of protection (sealant) to the wood of your unit. Prior to the application of sealant, lightly sand any "rough" spots on your playcenter. Please note this is a requirement of your warranty.
4. Assembling and maintaining the playcenter on a level location is very important. As your children play, your playcenter will slowly dig its way into the soil, and it is very important that it settles evenly. Make sure the playcenter is level and true one each year or at the beginning of each play season.

Disposal Instructions:

When the Playcenter use is no longer desired, it should be disassembled and disposed of in such a way that no unreasonable hazards will exist at the time the unit is discarded.

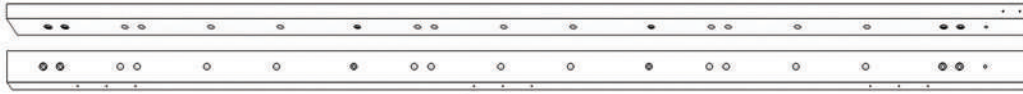

① x1 76.4in

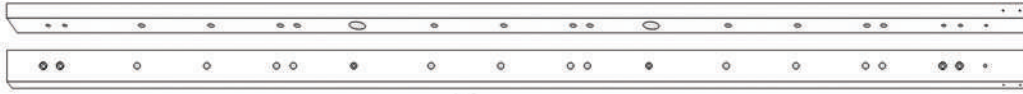

② x1 76.4in



③ x1 78.7in



④ x1 78.7in



⑤ x1 78.7in

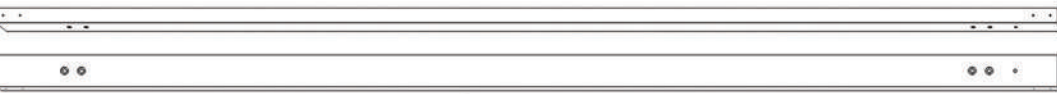

⑥ x1 78.7in



⑦ x1 78.7in

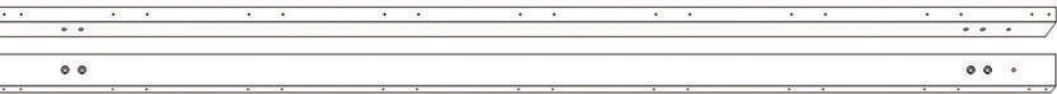

⑧ x1 78.7in



⑨ x1 76.4in

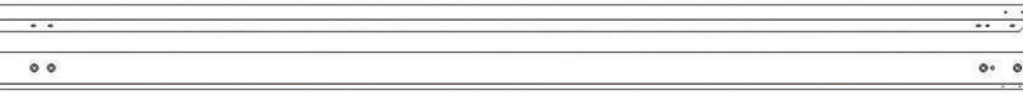

⑩ x1 76.4in



⑪ x1 78.7in

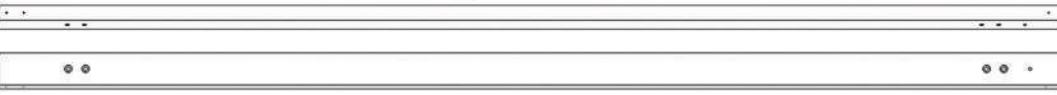

⑫ x1 78.7in

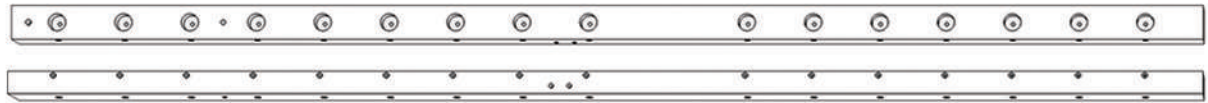

⑬ ×1 82.7in

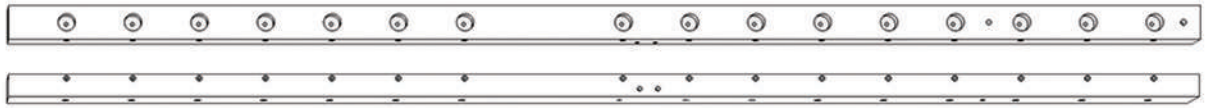

⑭ ×1 82.7in



⑮ ×1 84.4in



⑯ ×1 84.4in



⑰ ×2 29.5in



⑱ ×9 20.9in



⑲ ×16 21.7in



⑳ ×2 22.6in



㉑ ×11 23.6in



㉒ ×2 21.4in



㉓ ×5 21.4in



㉔ ×1 21.4in



㉕ ×1 21.4in



㉖ ×1 21.4in



㉗ ×2 21.4in

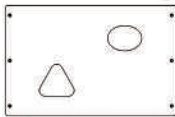

㉘ ×2 23.6in

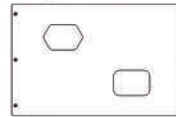

㉙ ×2 23.6in



㉚ ×7 23.6in

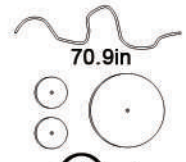

㉛ ×1



㉜ ×1



㉝ ×1



㉞ ×1



㉟ ×7



㊱ ×3 106.3in



㊲ ×1 189in

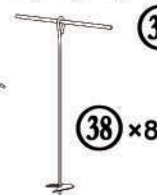

㊳ ×8



㊴ ×18



㊵ ×4



㊶ ×2



㊷ ×2



M4×20

Ⓐ ×32



M4×30

Ⓑ ×166



M5×40

Ⓒ ×52



M5×50

Ⓓ ×44



M7×50

Ⓔ ×36



M10×40

Ⓕ ×14



M6×60

Ⓖ ×4



M6×20

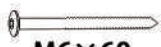

M6×60

Ⓗ ×48



M6×80

Ⓘ ×20



M10×13

Ⓙ ×68

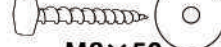

M8×50

Ⓚ ×8

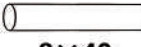

8×40

Ⓛ ×8



M4

Ⓜ ×2



M8

Ⓝ ×1



M16

Ⓞ ×1

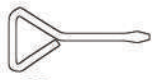

Ⓟ ×1

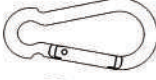

Ⓠ ×2



Ⓡ ×2

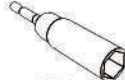



Ⓡ ×1

A1-1

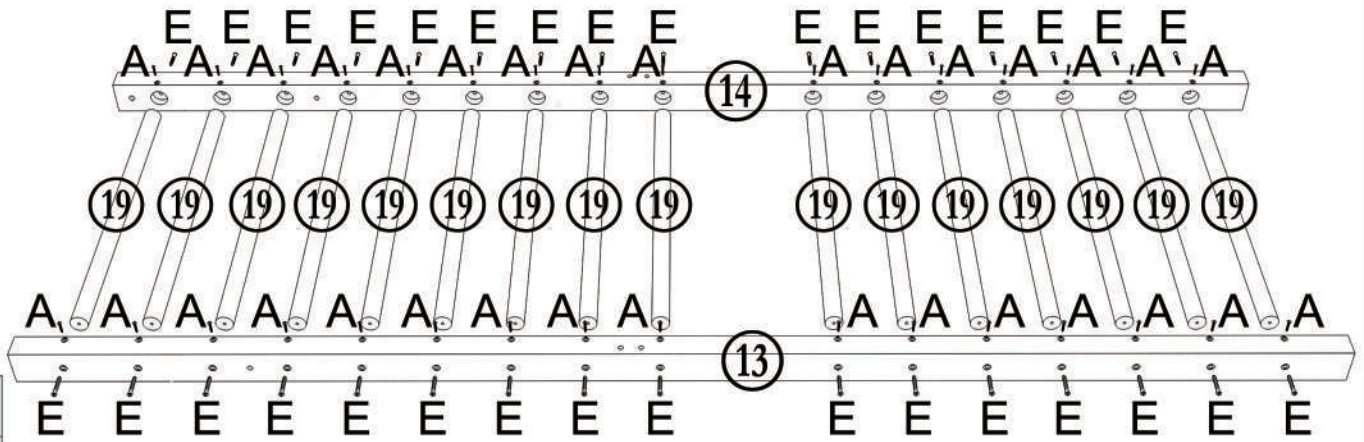
NOTE: Check all connections and bolts for tightness at least twice monthly during use. Do not use if screws are loose.



⑬	1		
⑭	1		
⑰	16		
A		M4X20	32
E		M7X50	32

A1-2

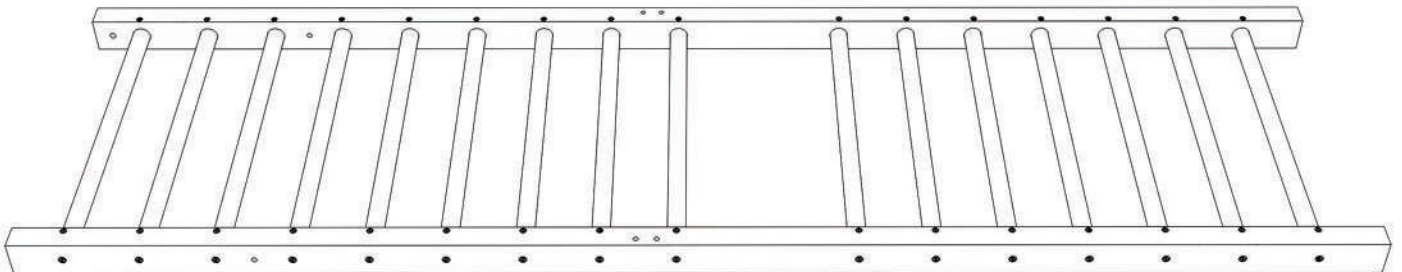

A2-1

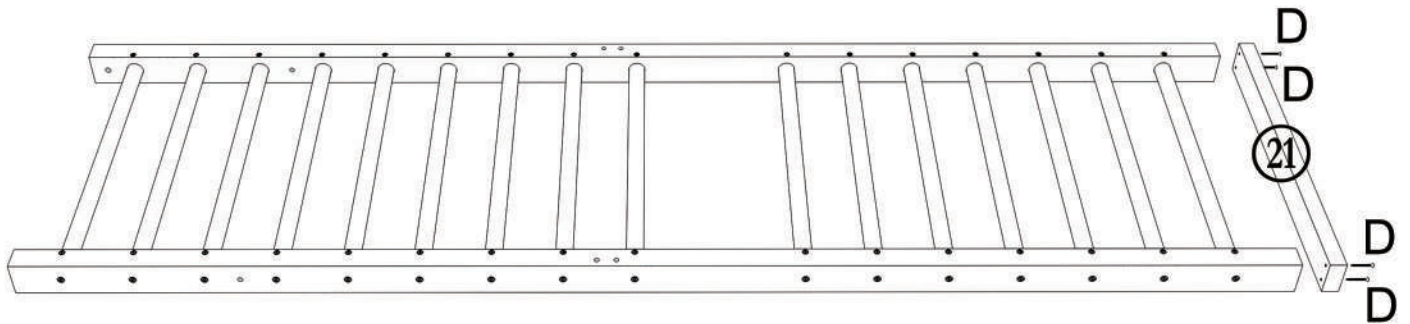

21	1	
D	 M5X50	4

A2-2

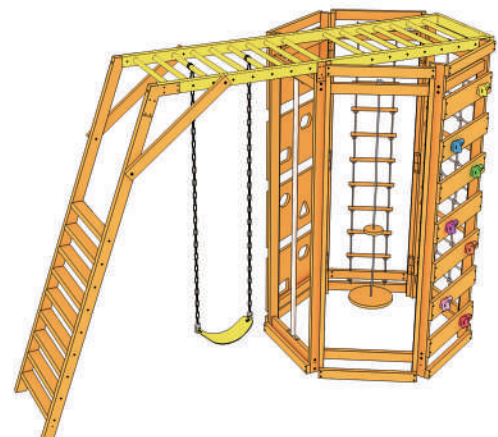
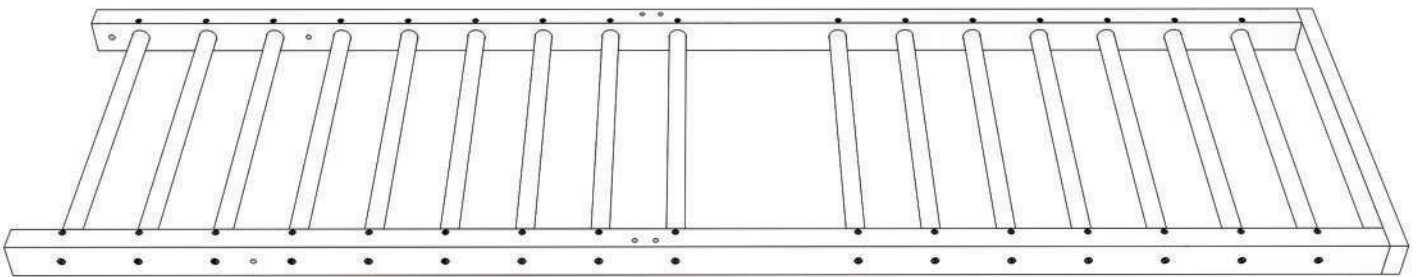

A3-1

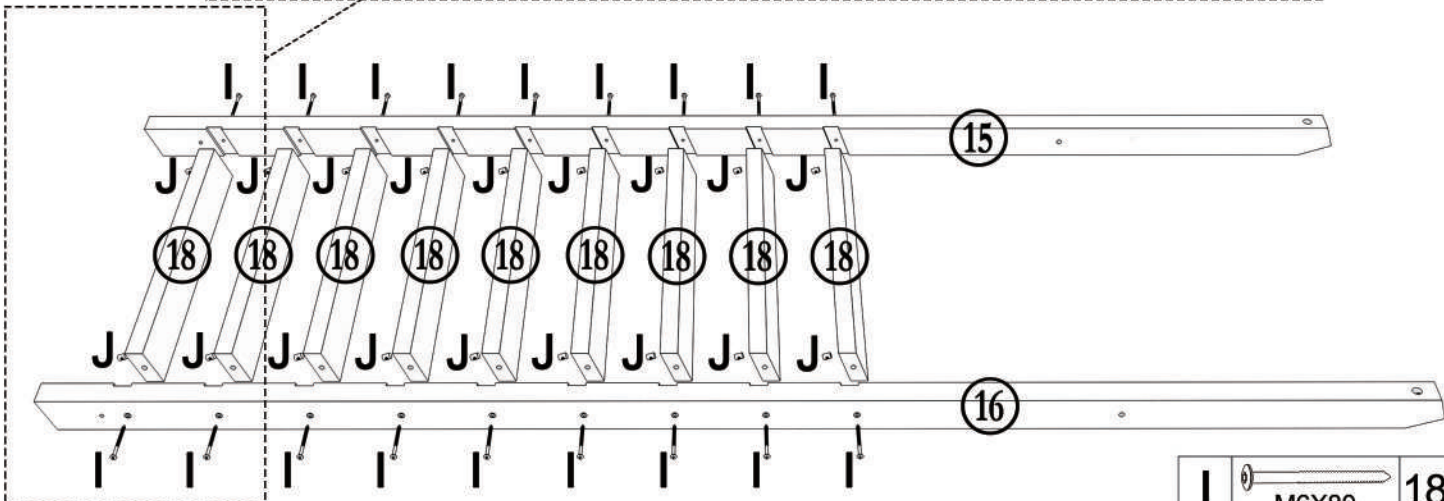
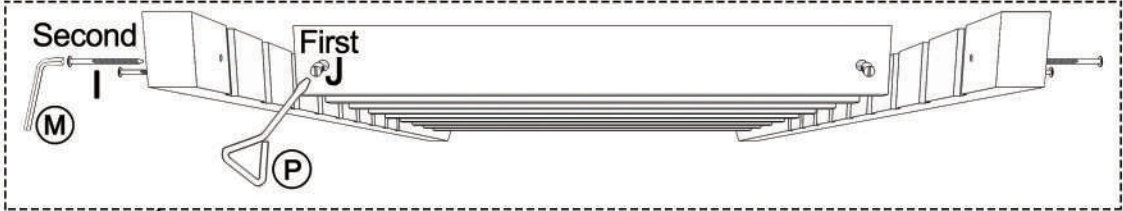

Note: Put Part J with the notch outwards into the hole as shown, insert Part I into the corresponding hole, adjust Part J with tool P, align the hole of Part J with Part I, and tighten Part I with tool M.

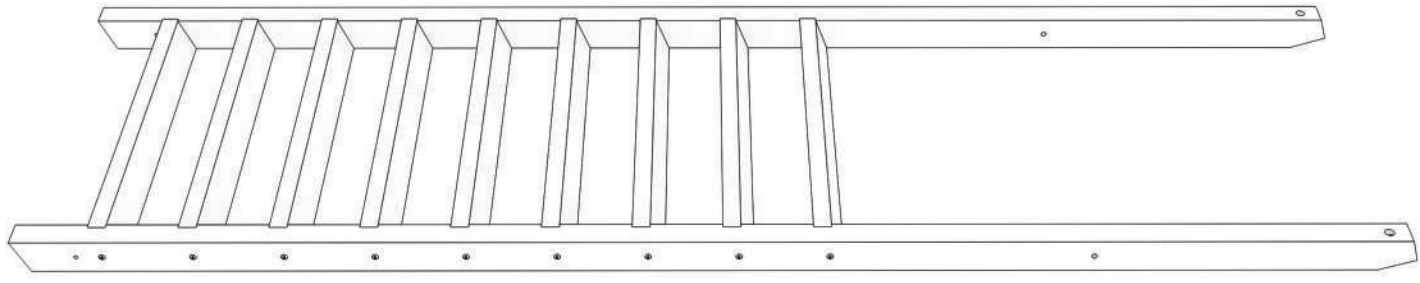

		I	M6X80	18
(15)	1	J	M10X13	18
(16)	1	M	M4	1
(18)	9	P		1

A3-2

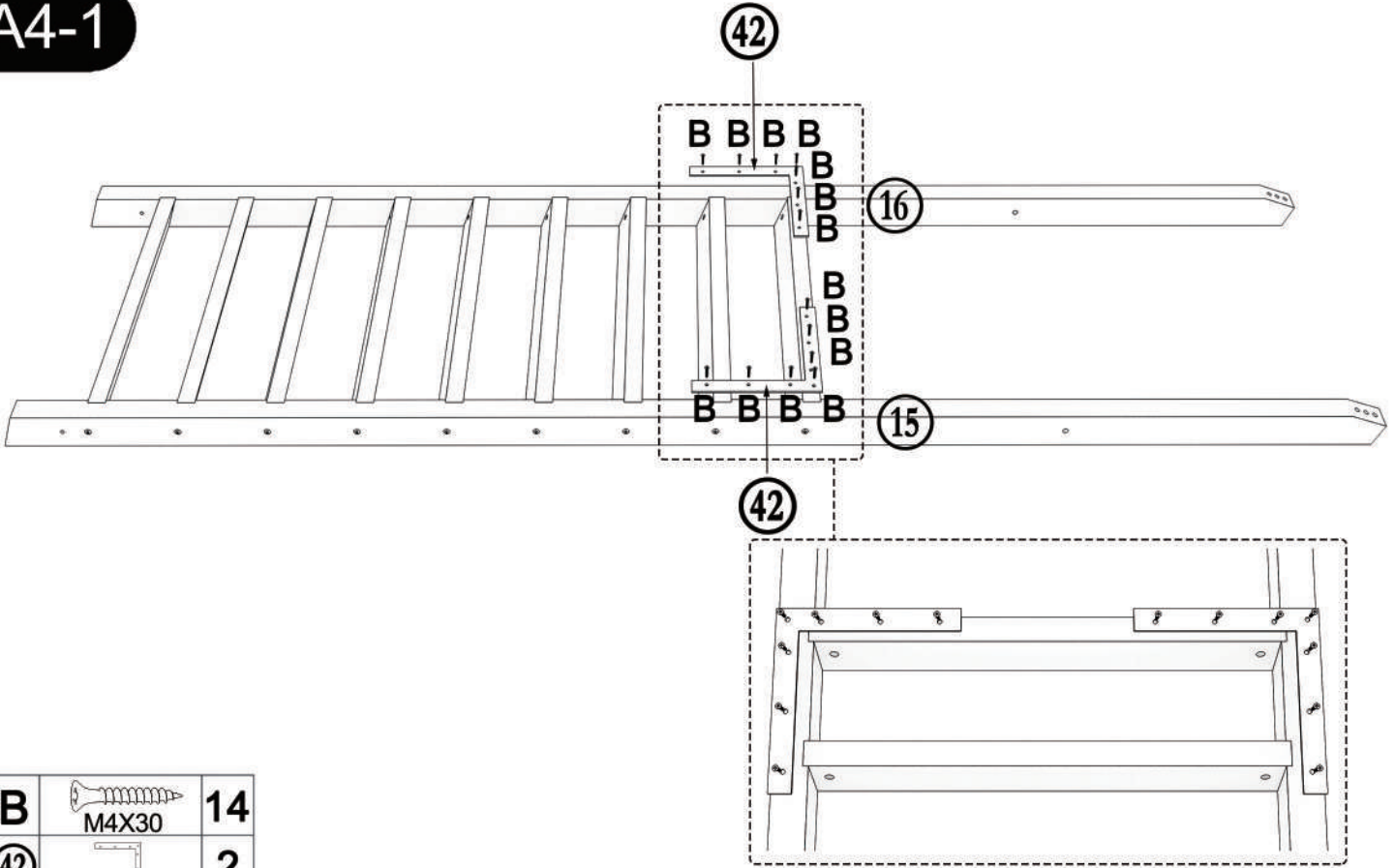

A4-1





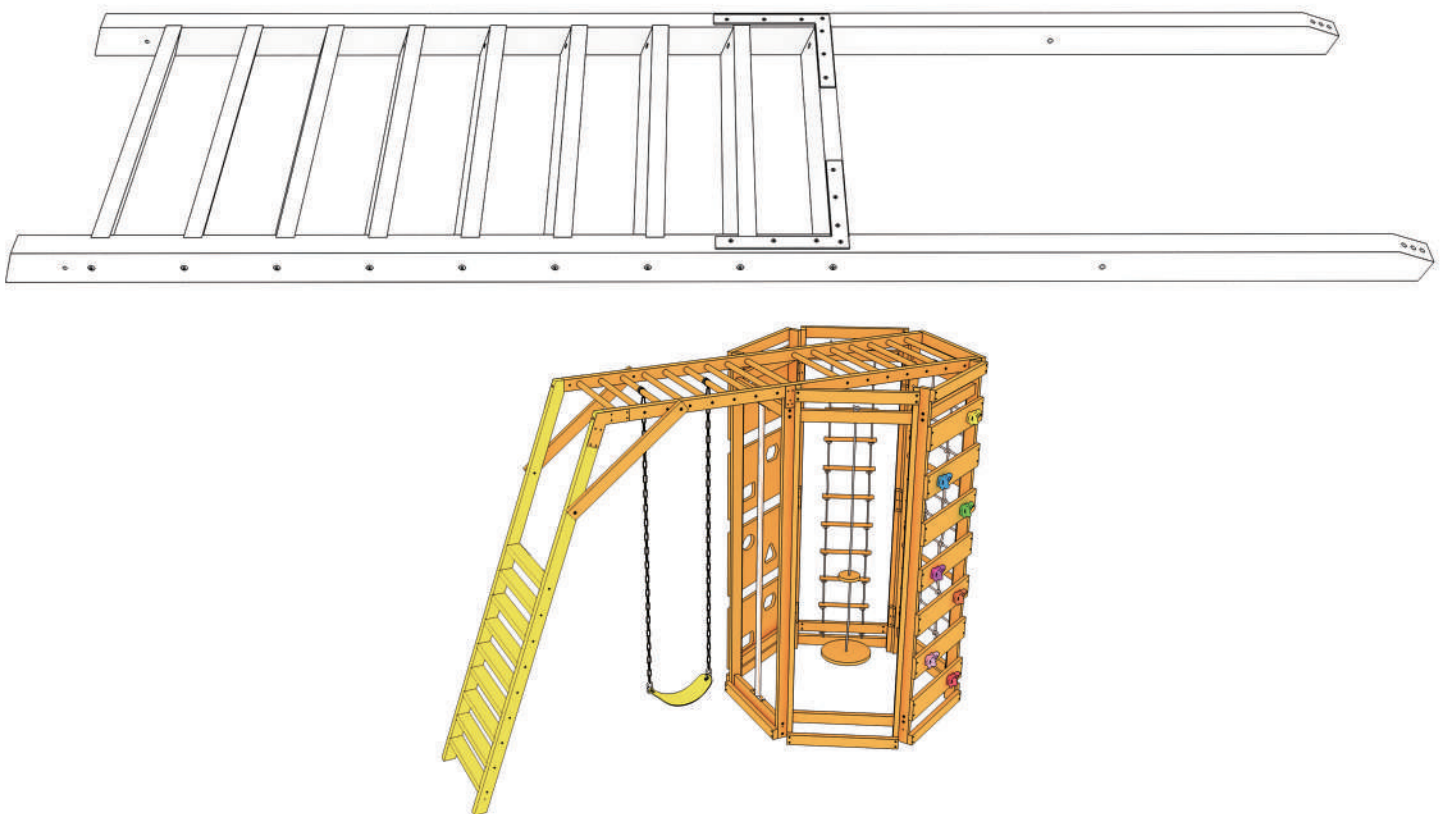

B	 M4X30	14
42		2

A4-2

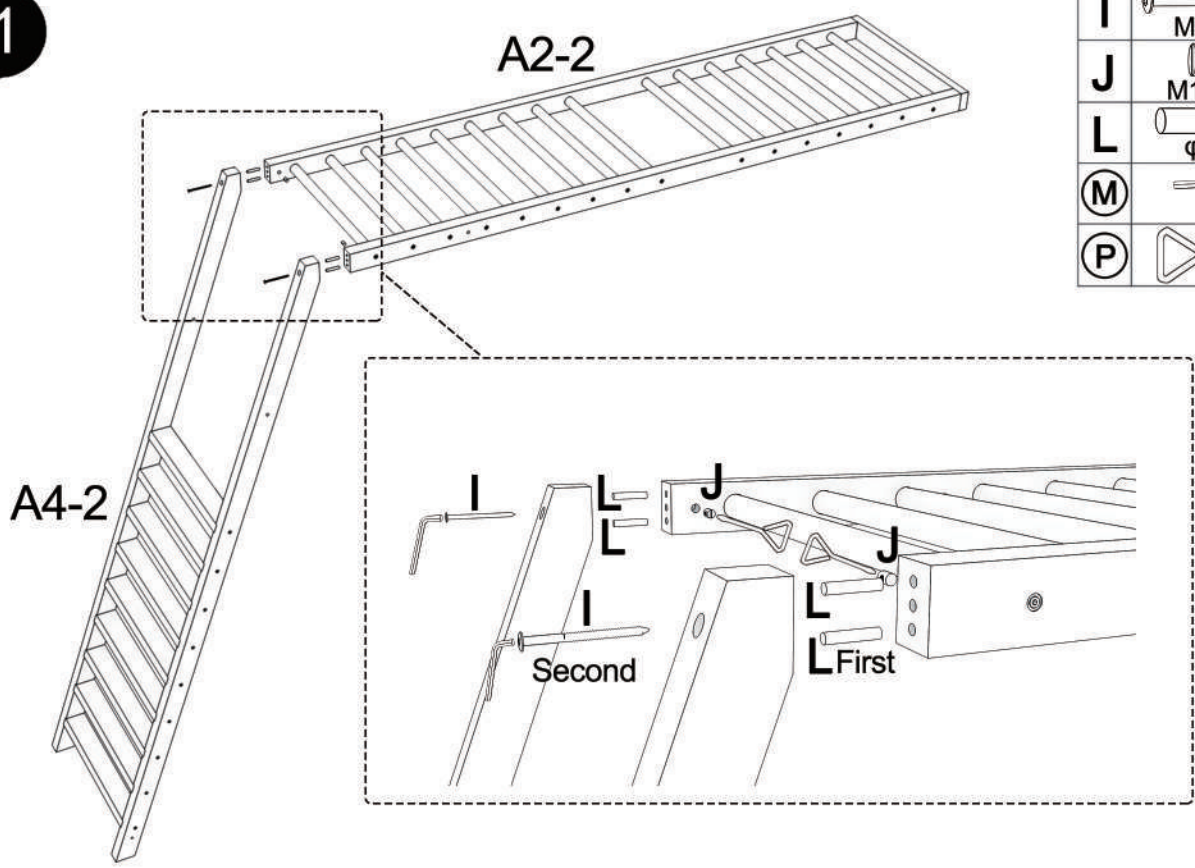

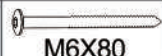
A5-1

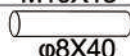

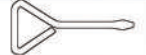
I		2
J		2
L		4
(M)		1
(P)		1

A5-2

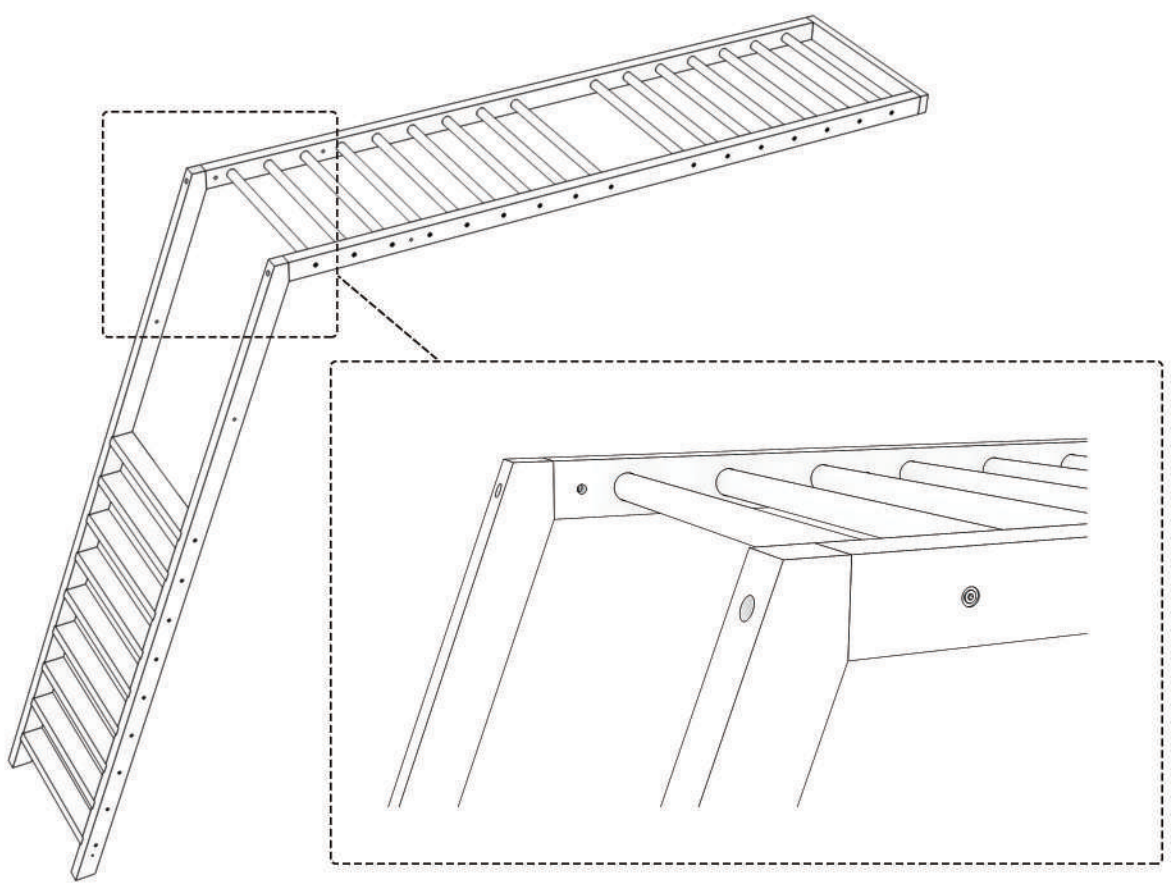

A6-1

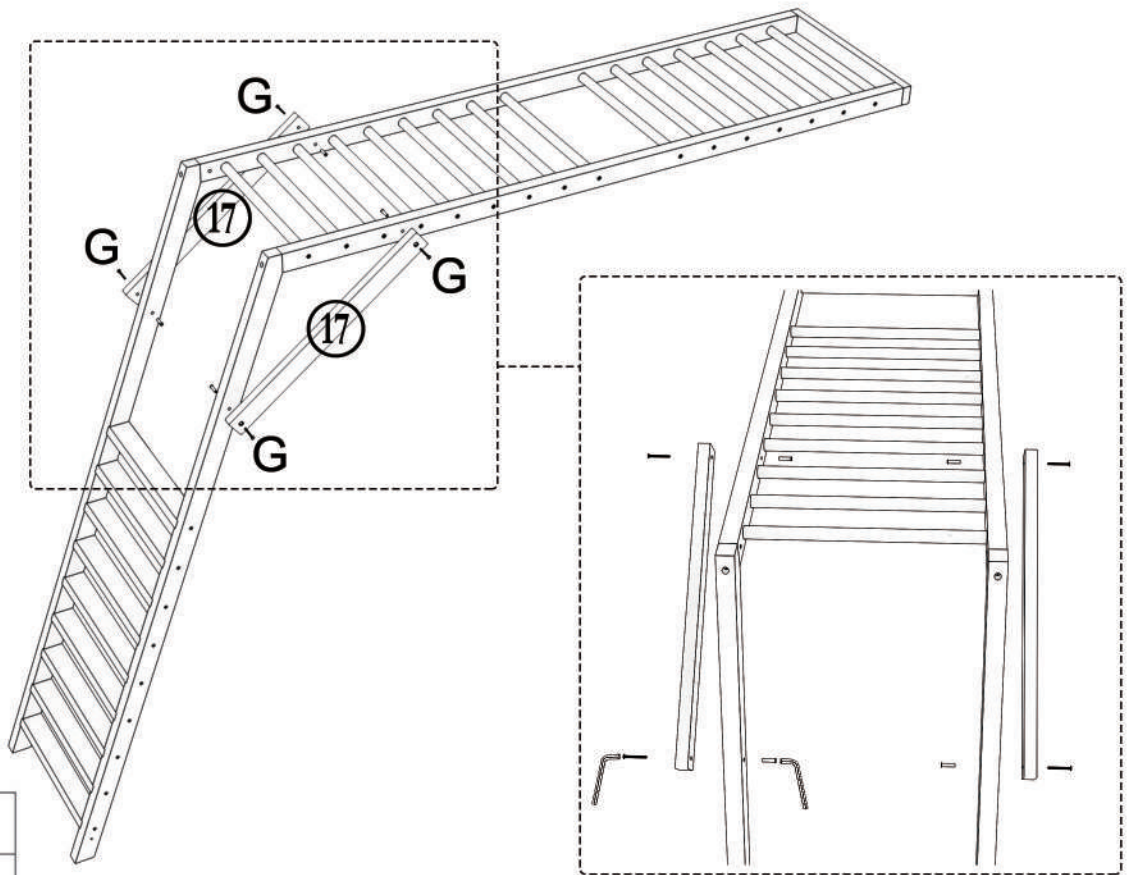

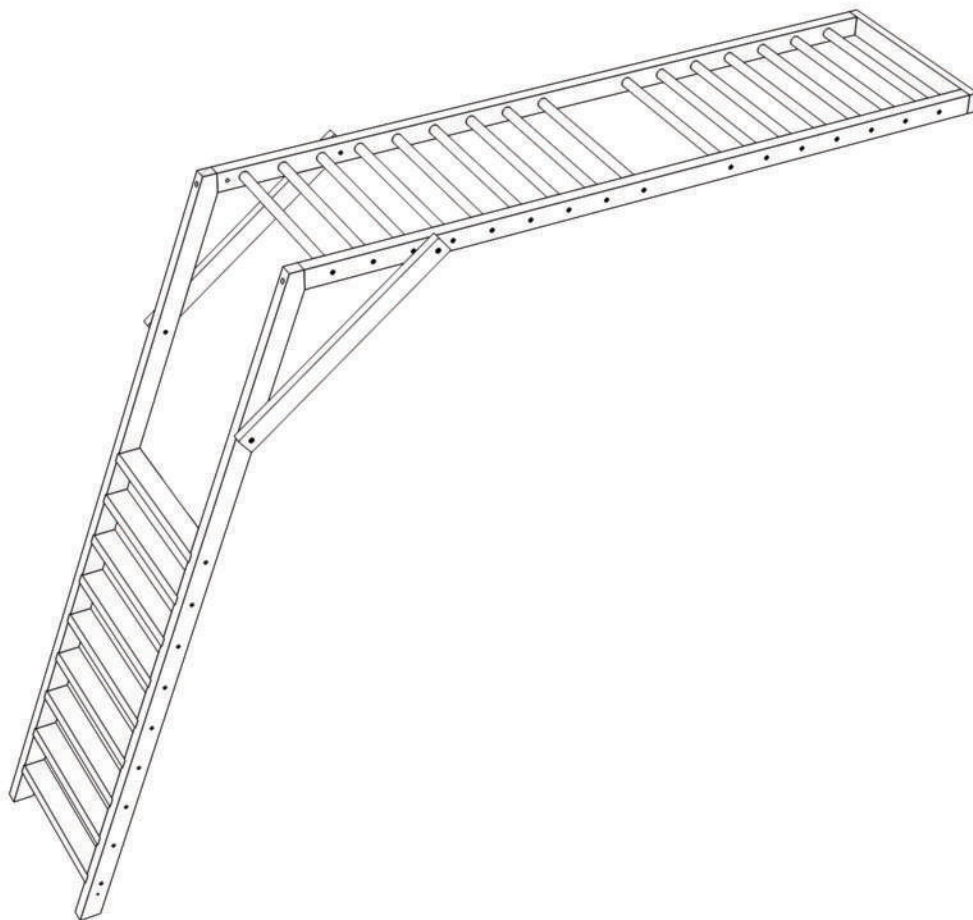

17	2	
G	M6X60 M6X20	4
M	M4	2

A6-2

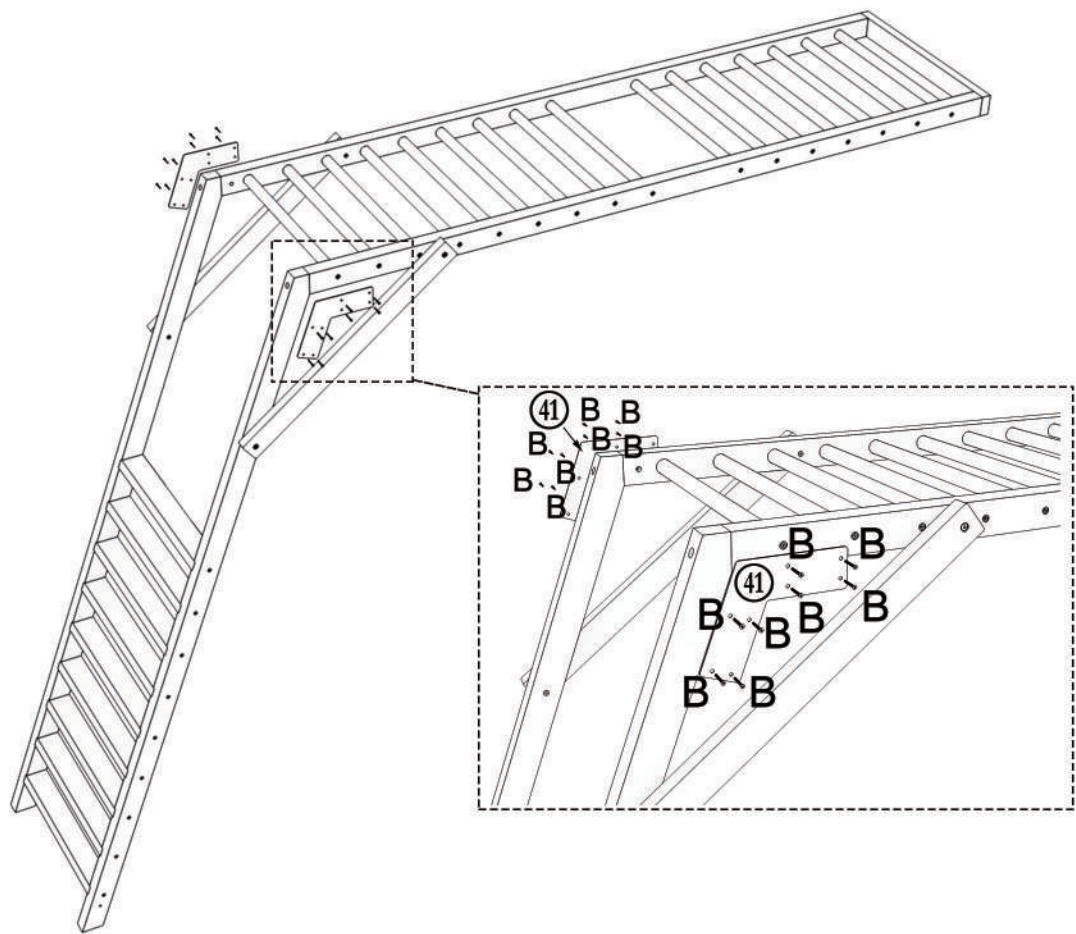

A7-1



B		16
41		2

A7-2

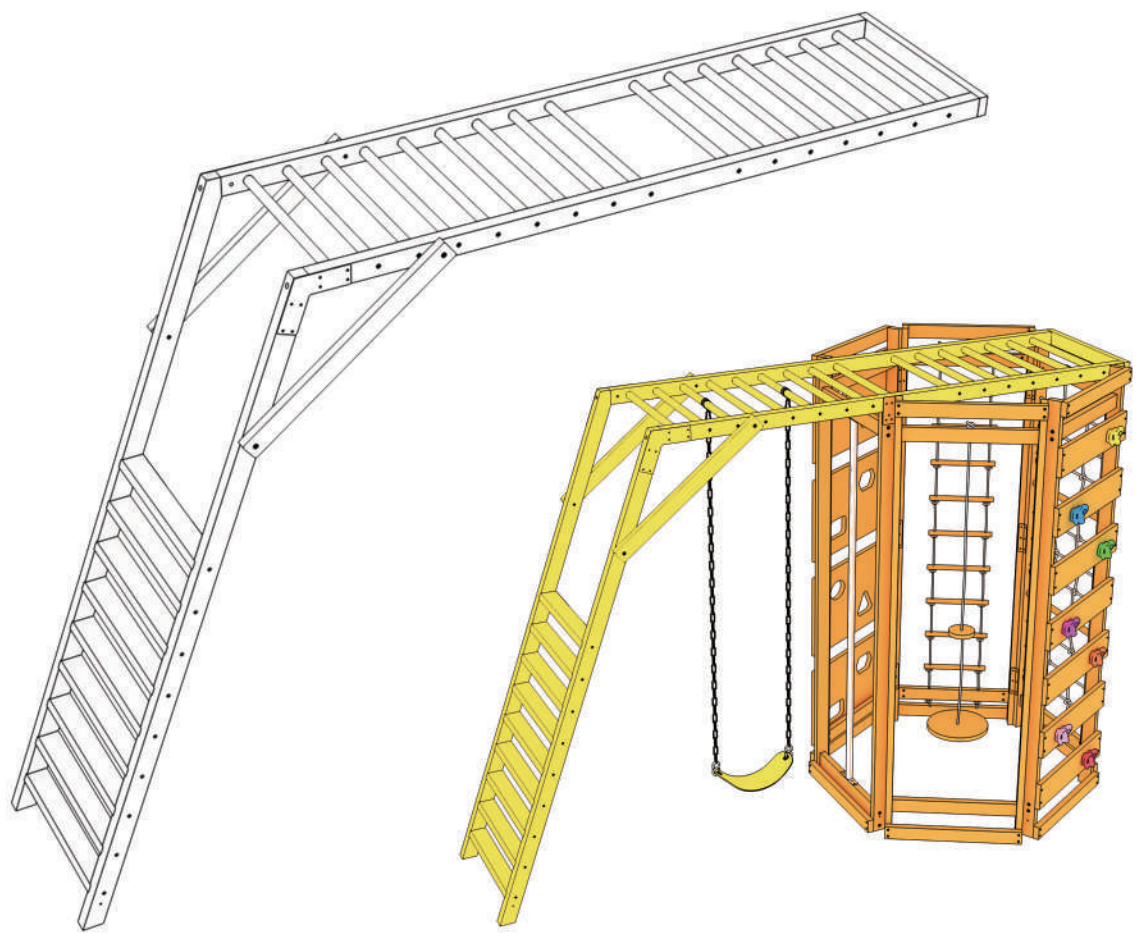

B1-1

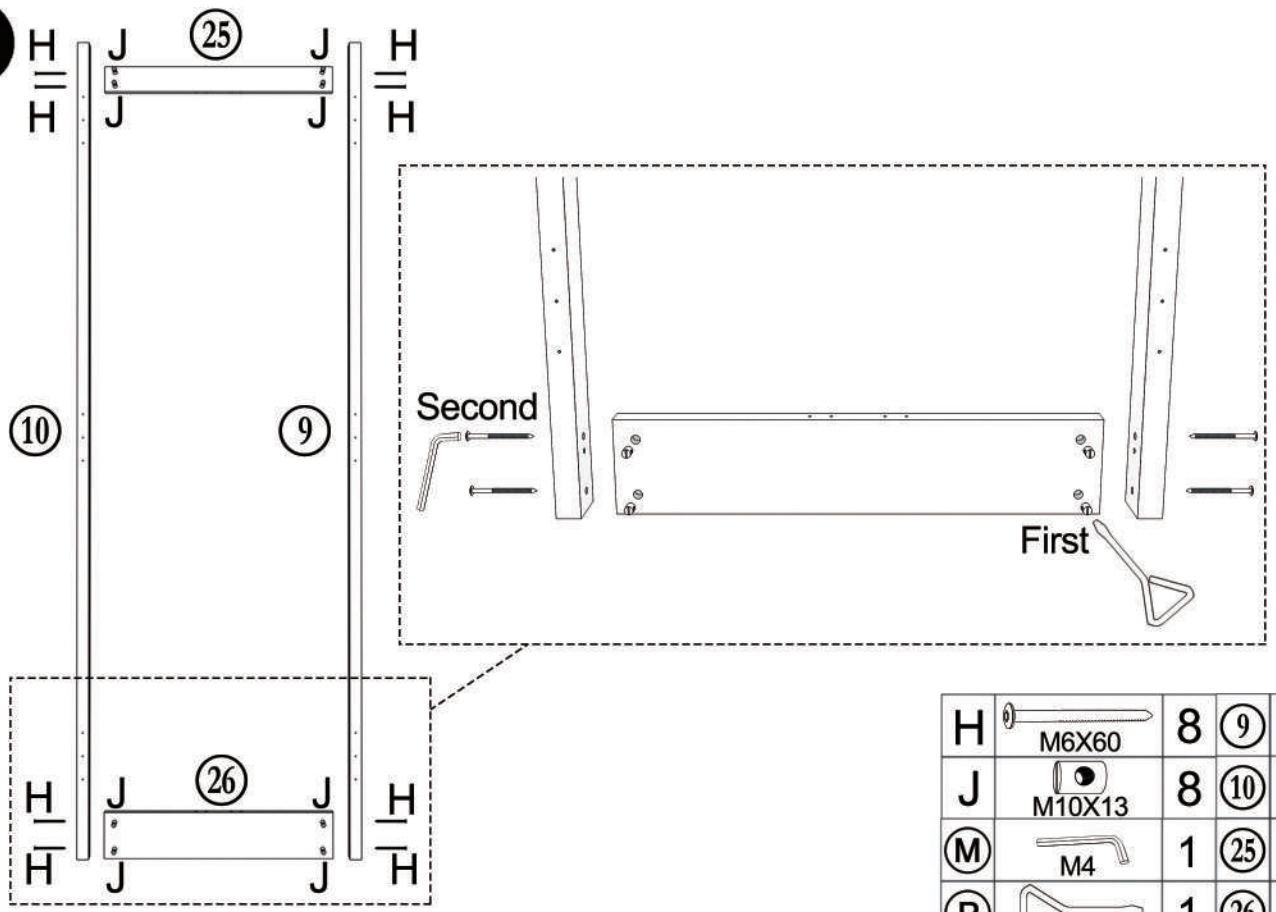

B1-2

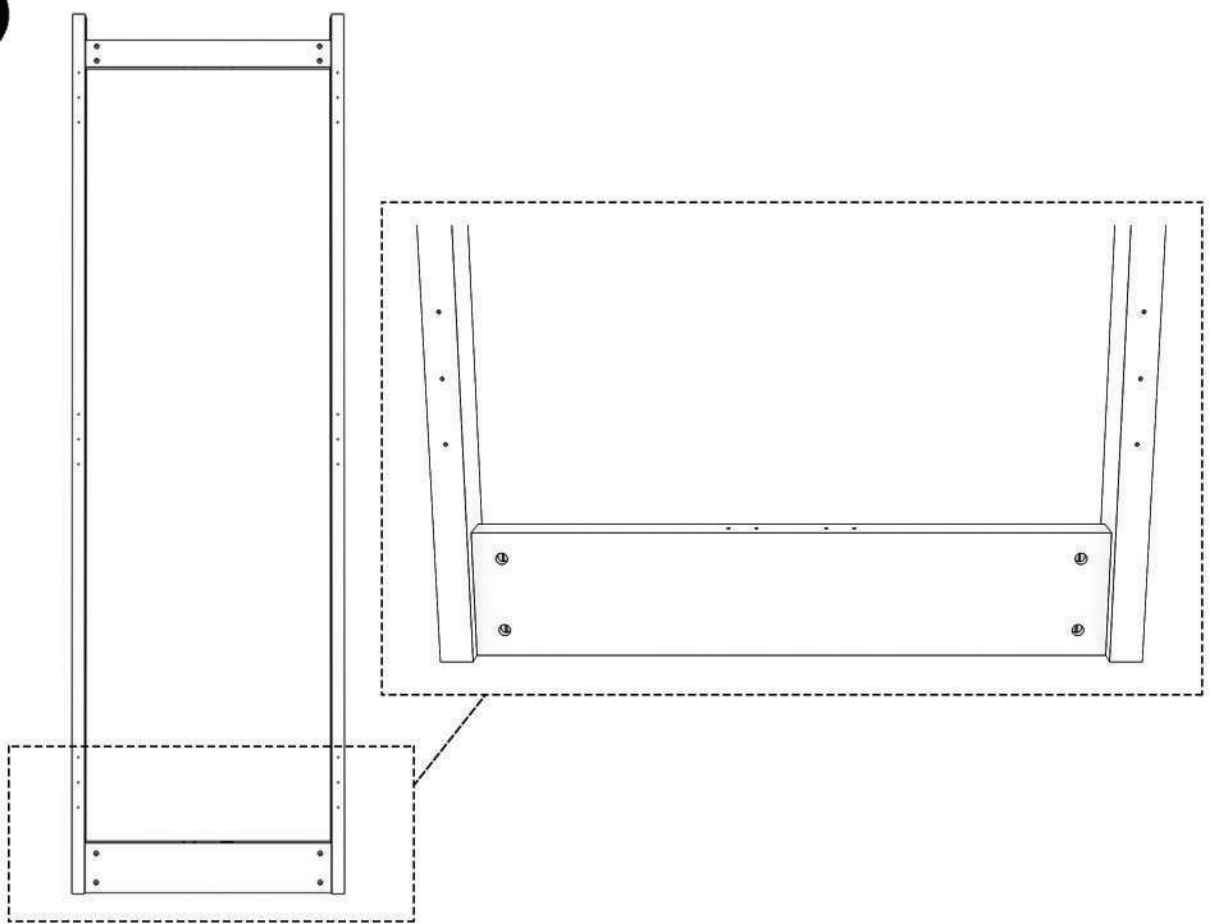

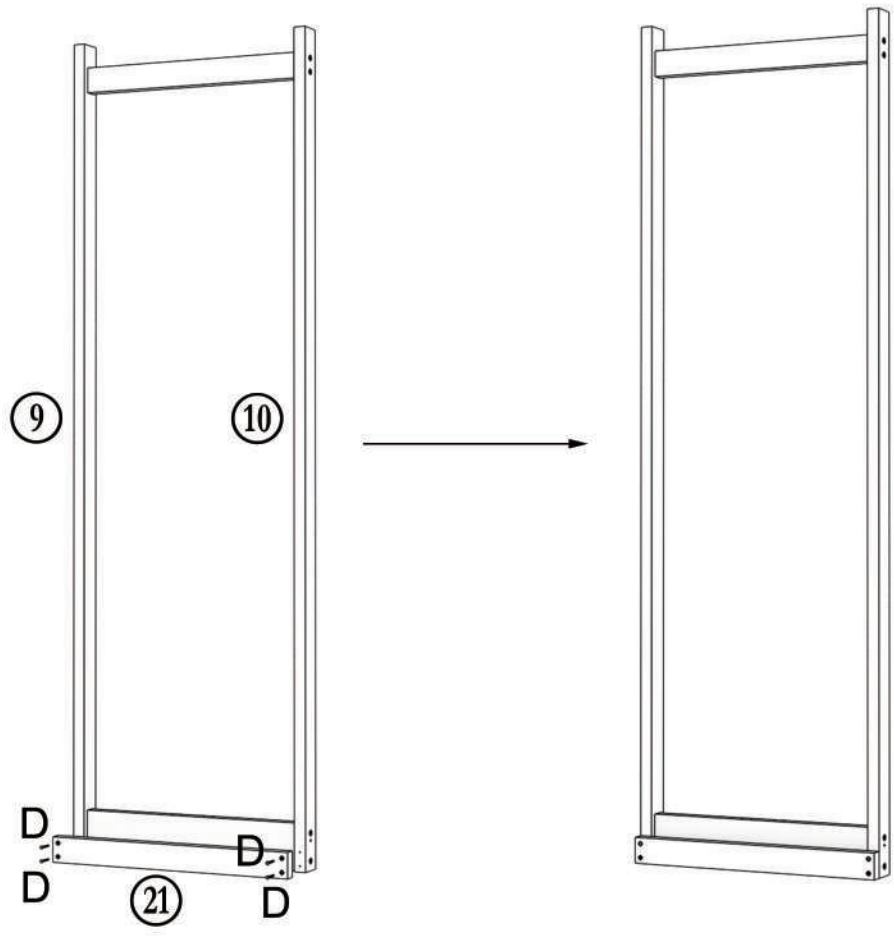

B2-1



21	1	
D	 M5X50	4

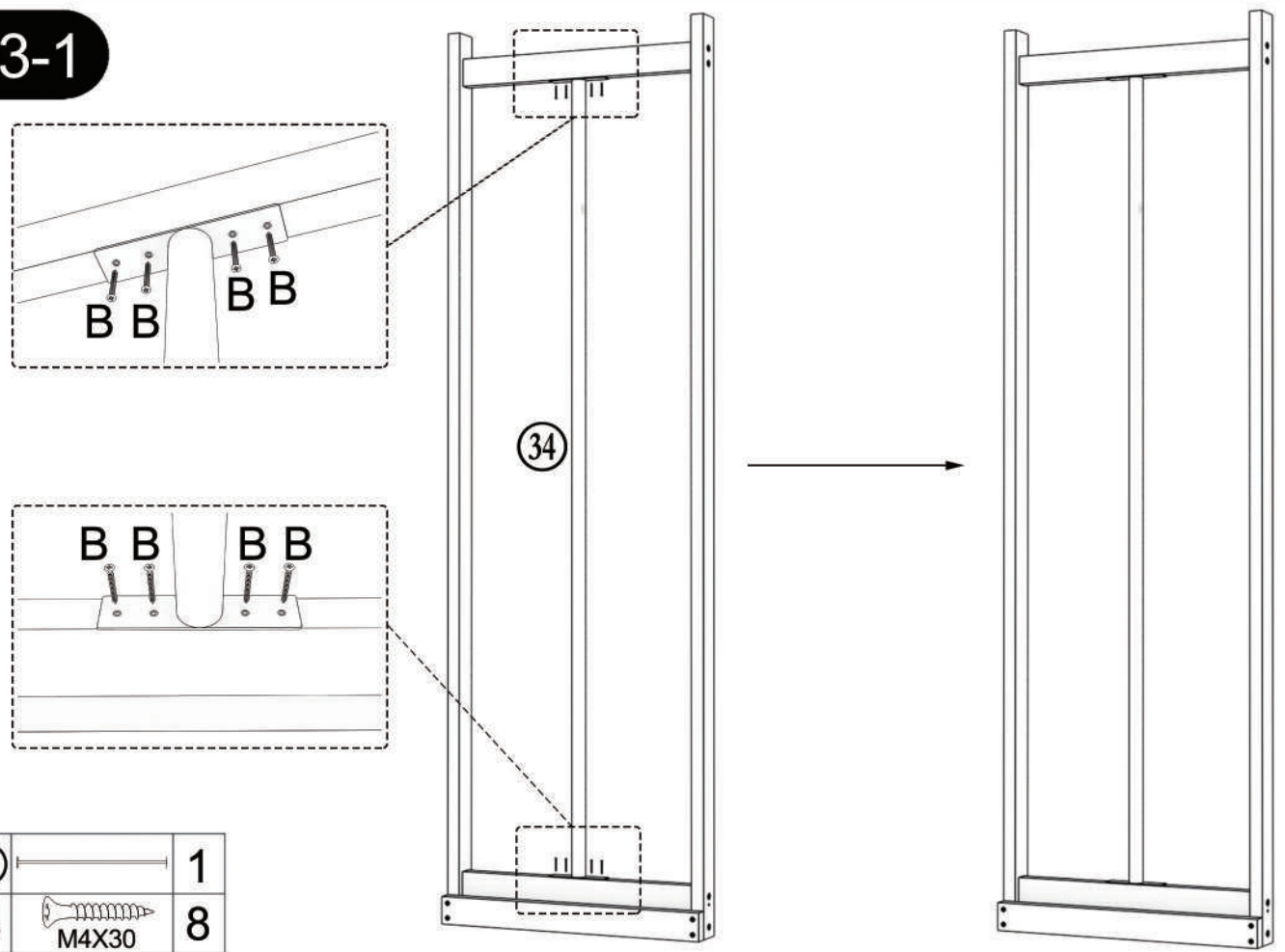

B3-1



34		1
B	 M4X30	8

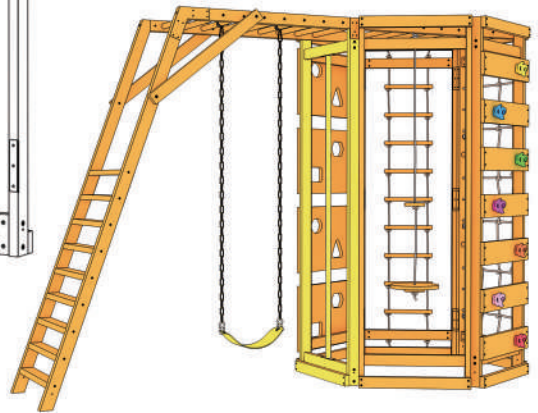
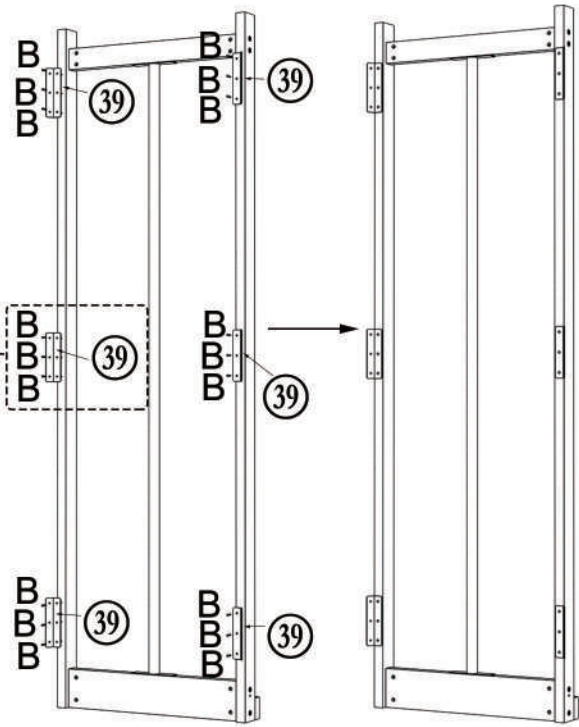
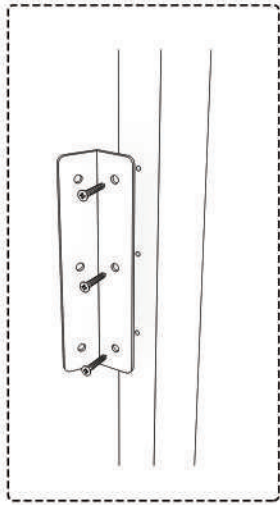



B4-1

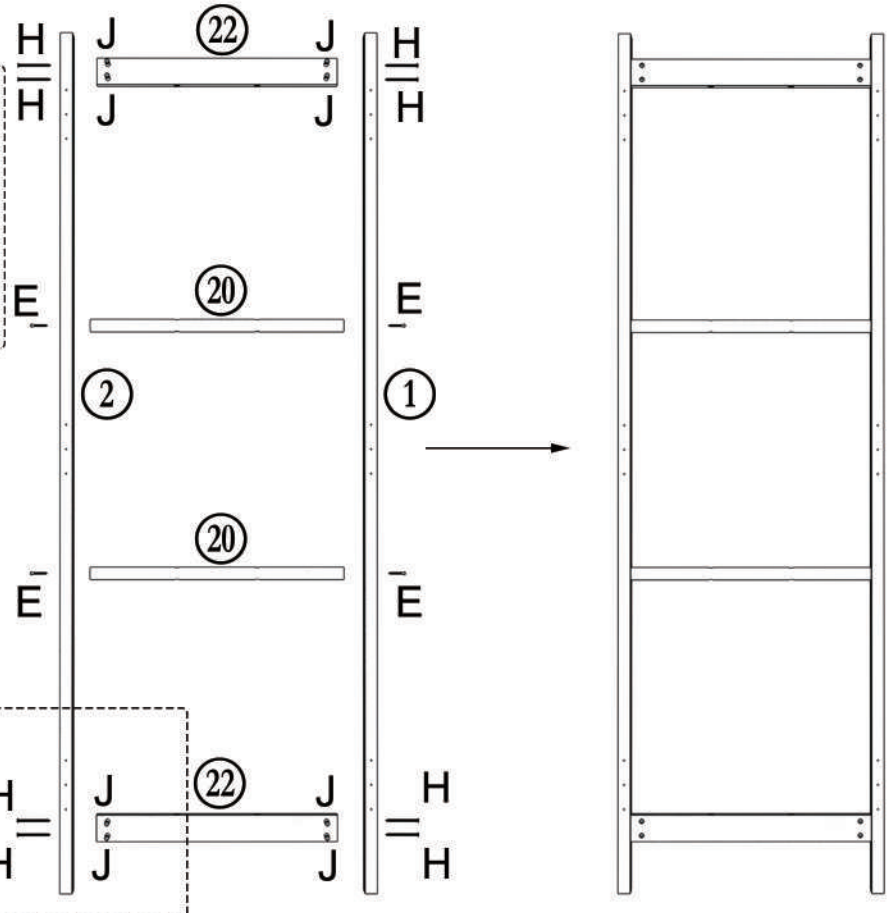
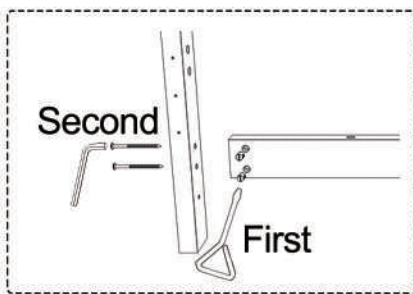

B	 M4X30	18
39		6

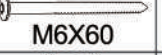
C1-1

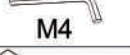

1	1	
2	1	
20	2	
22	2	
E	 M7X50	4
H	 M6X60	8
J	 M10X13	8
M	 M4	1
P		1

C2-1

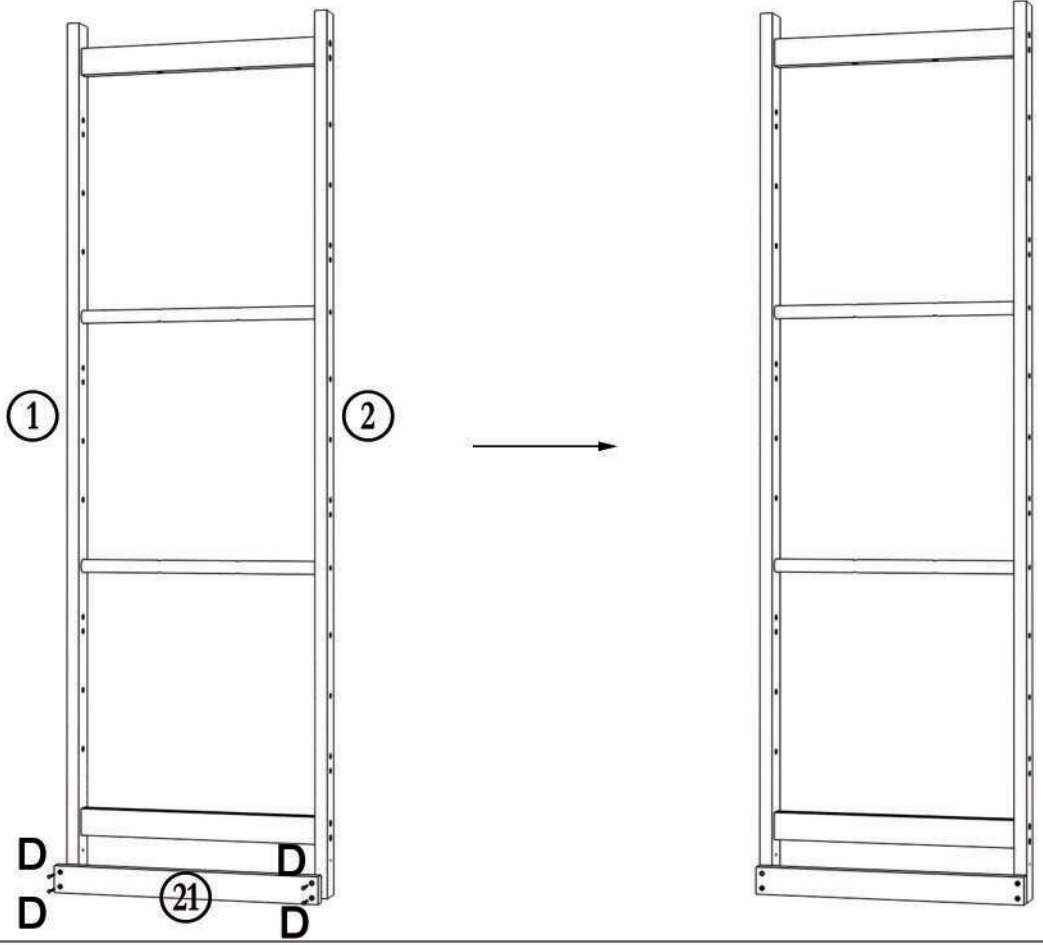

21	1
D	 4
M5X50	

C3-1

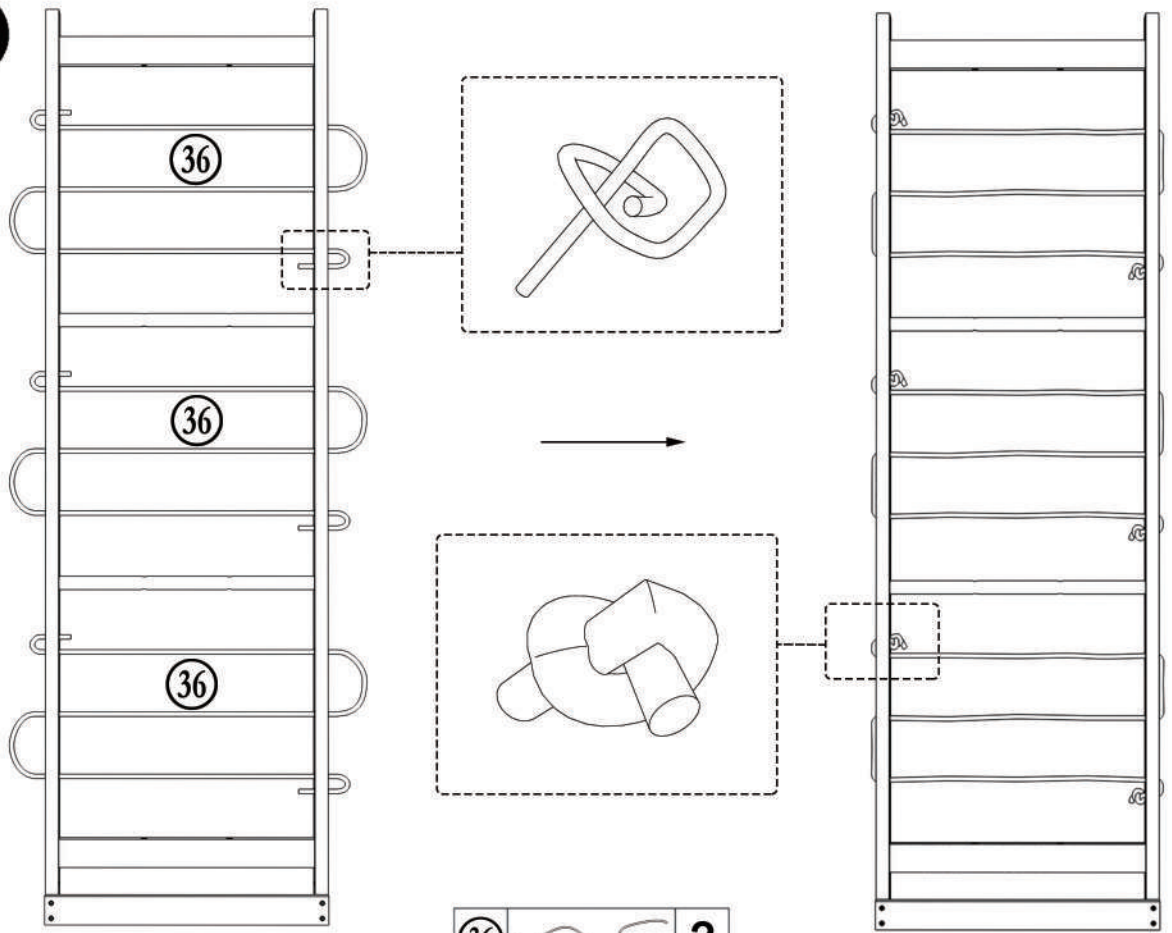

36		3
----	-------------------------------------------------------------------------------------	---

C4-1

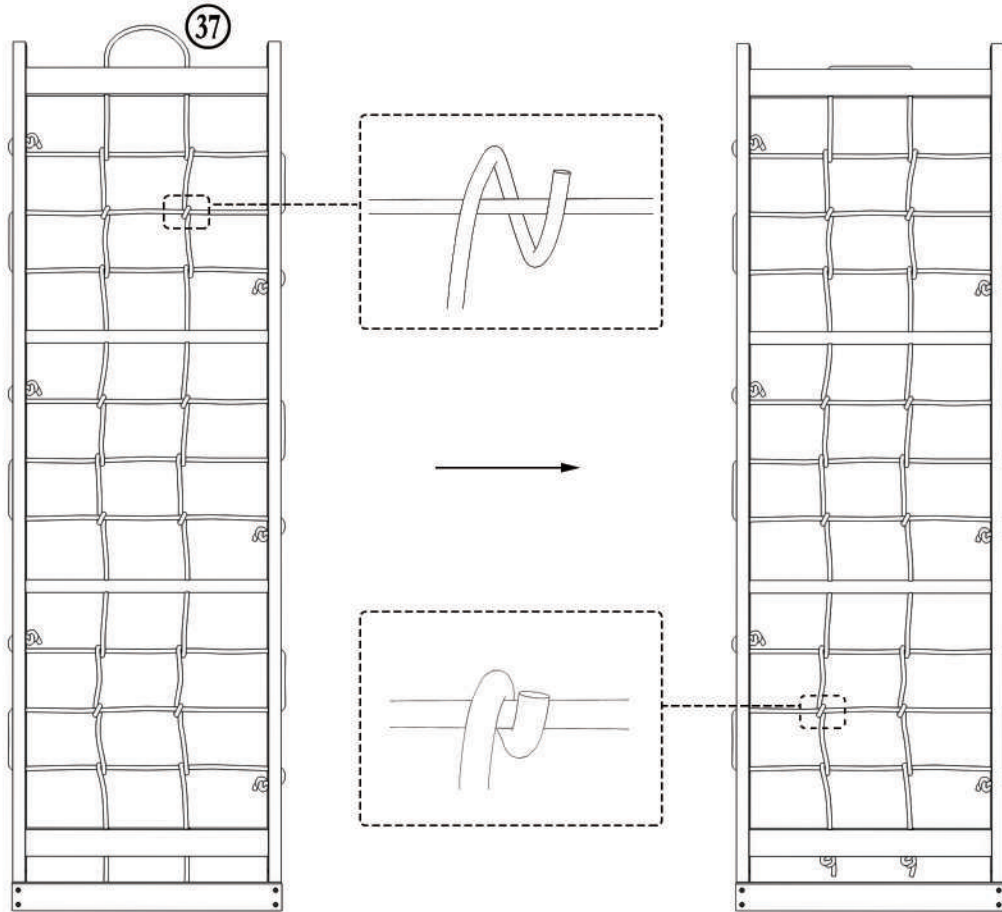

37		1
----	--	---

C5-1

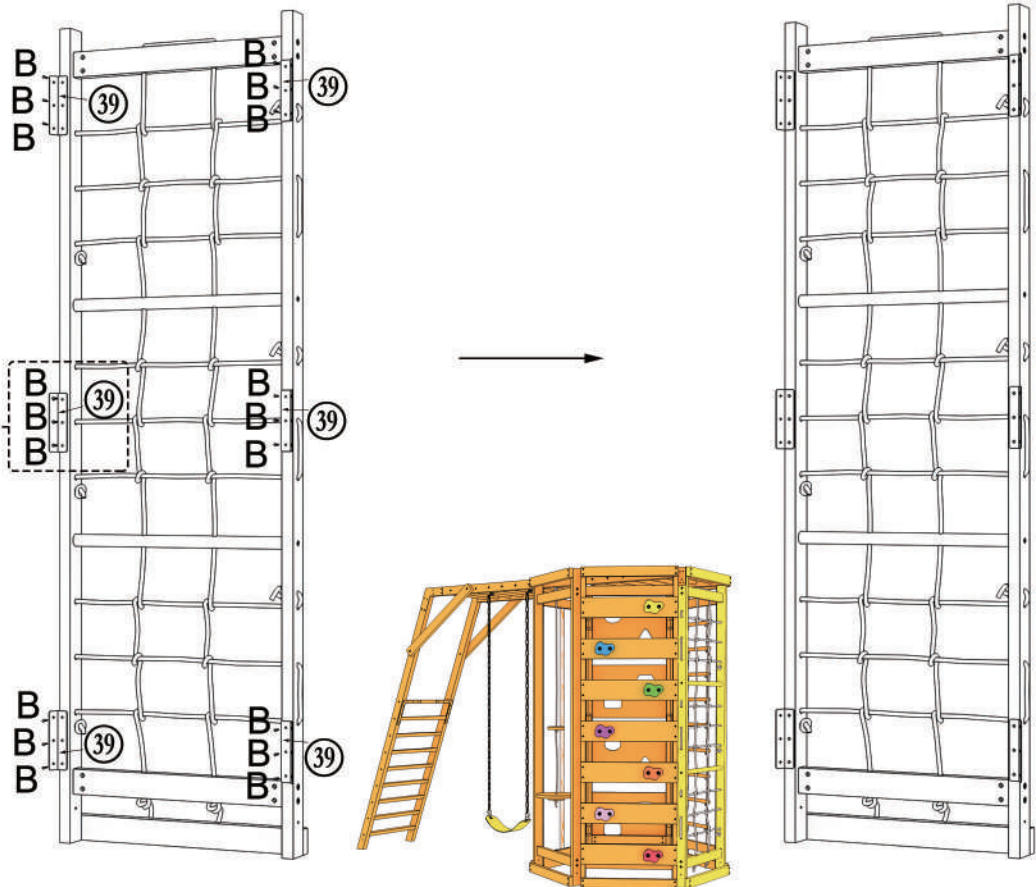
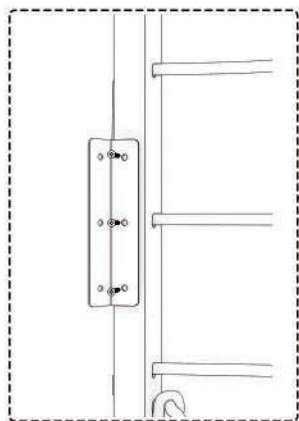

B		18
39		6

D1-1

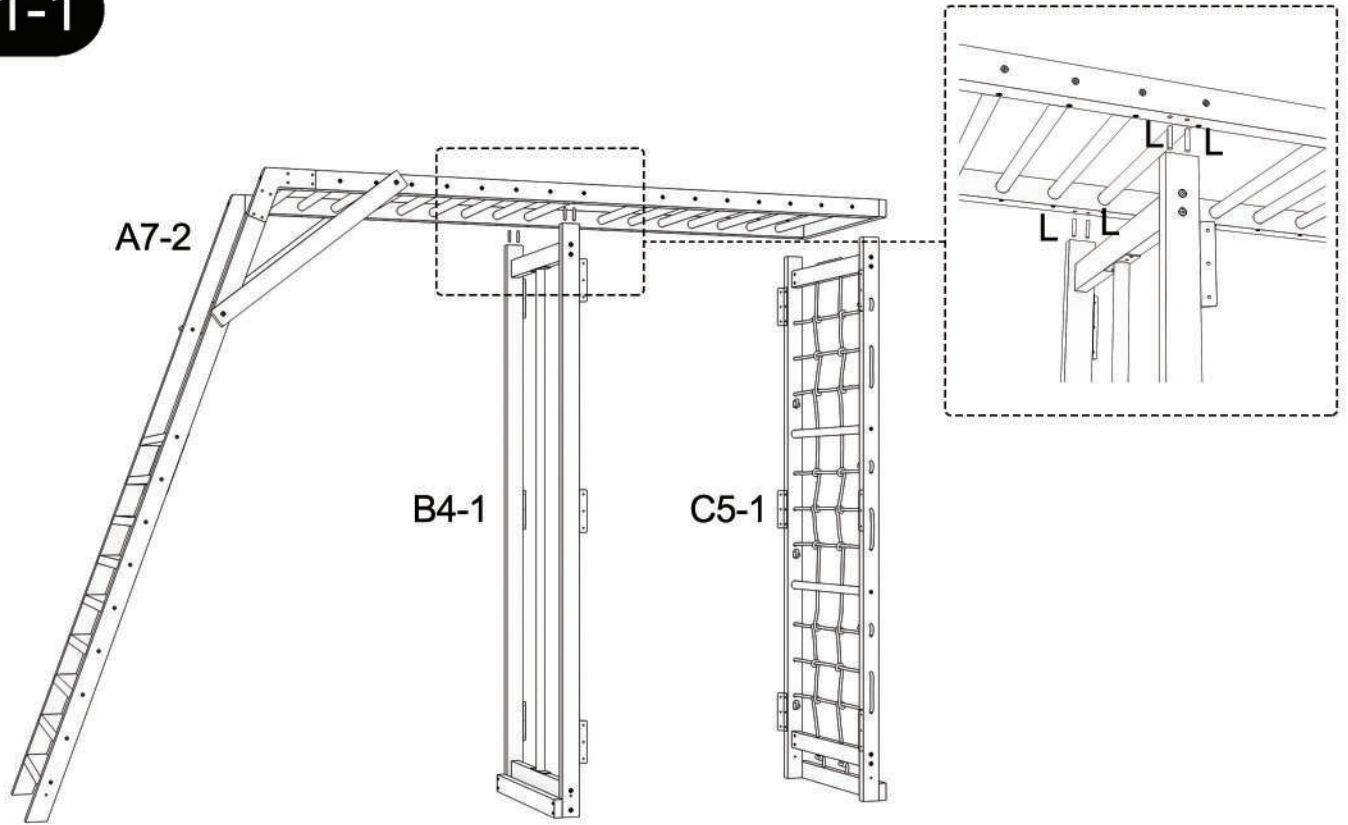

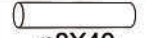

L		4
	$\phi 8 \times 40$	

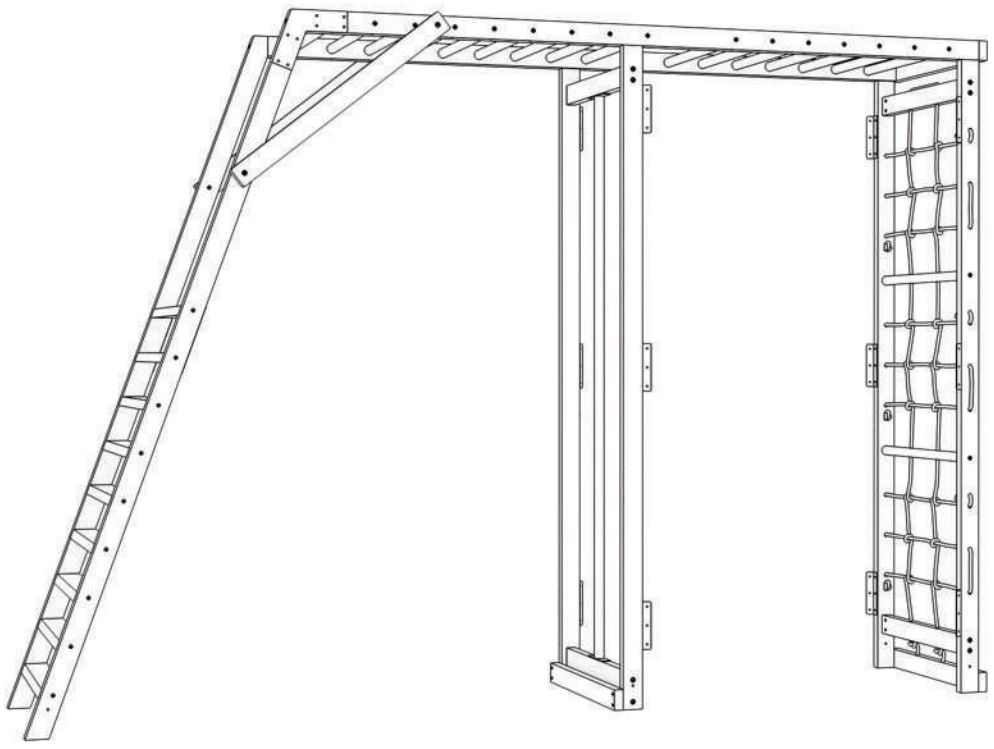
D1-2

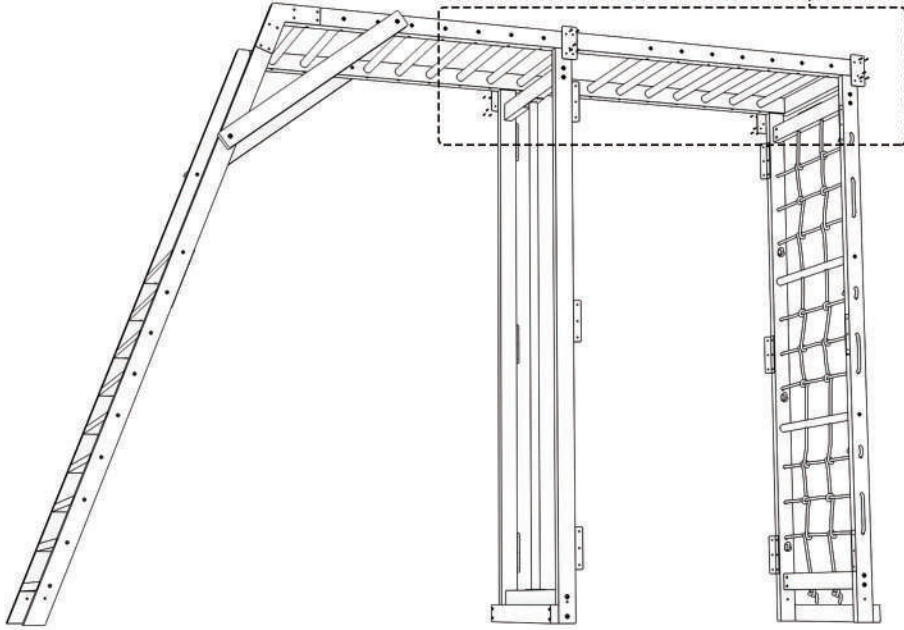
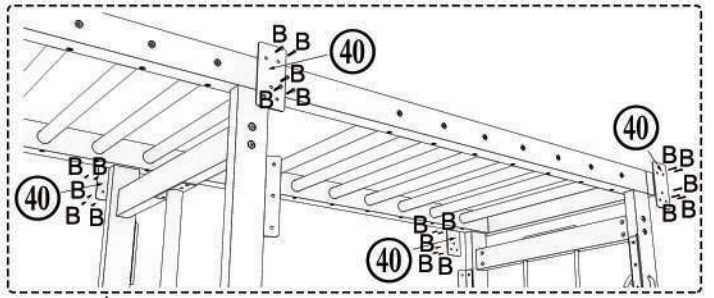

D2-1





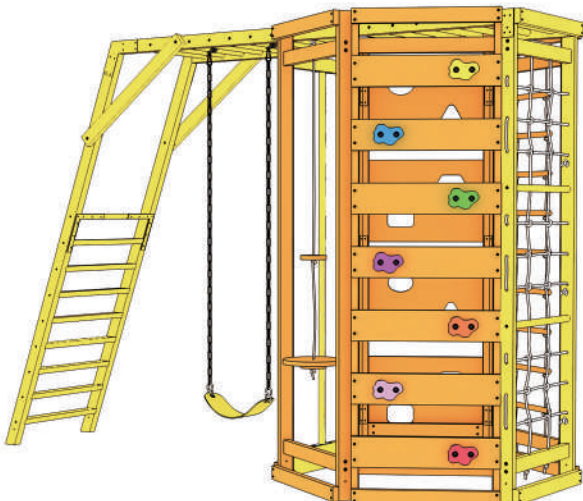
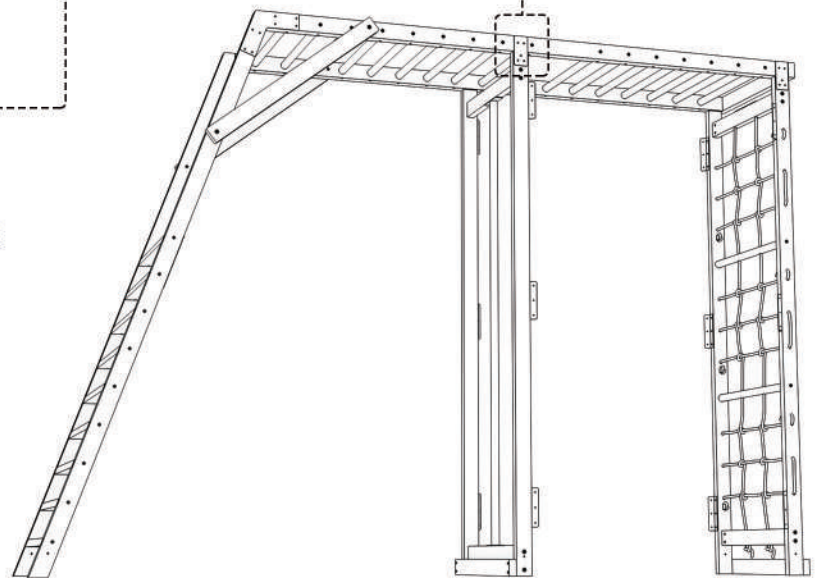
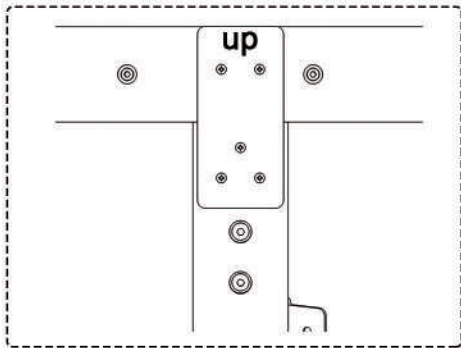

B	 M4X30	20
40		4

D2-2

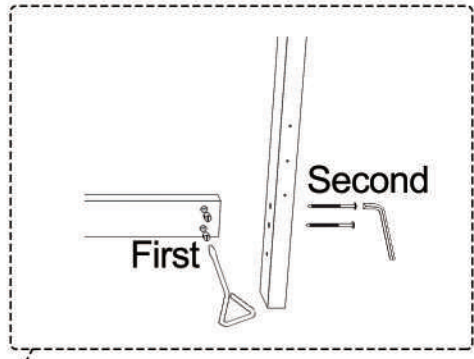
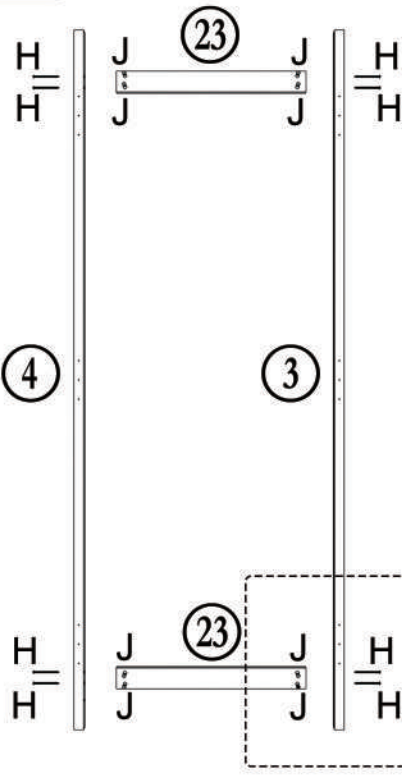

E1-1



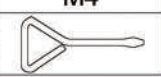

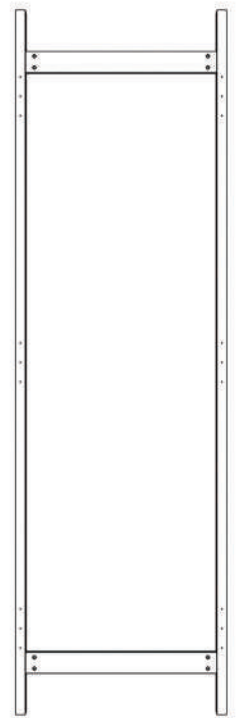
		H		M6X60	8
(3)	1	J		M10X13	8
(4)	1	(M)		M4	1
(23)	2	(P)			1

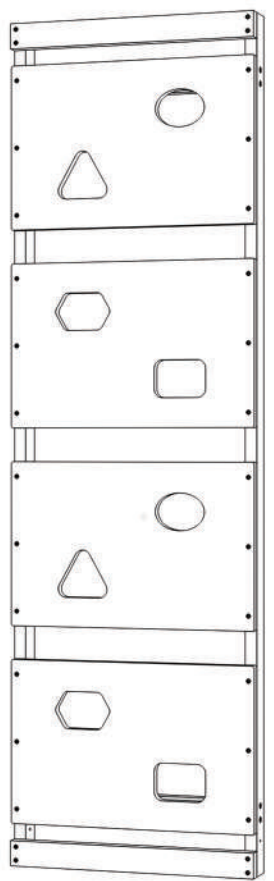
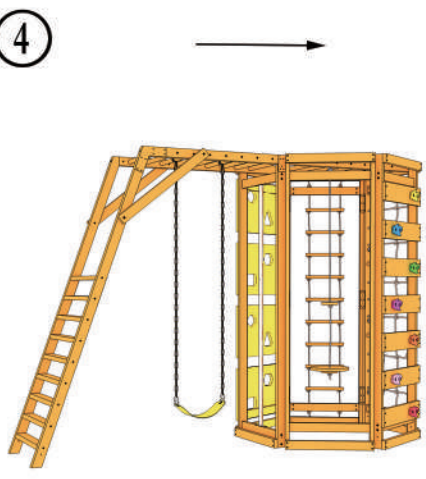
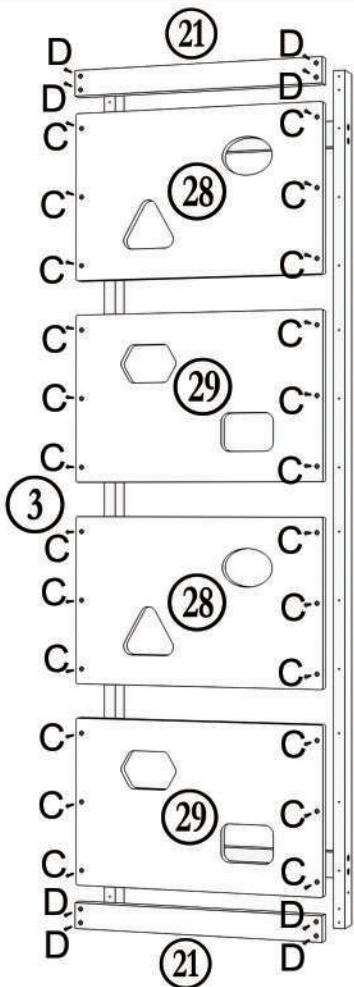

E2-1



(21)	2			
(28)	2			
(29)	2			
C		M5X40	24	
D		M5X50	8	

F1-1

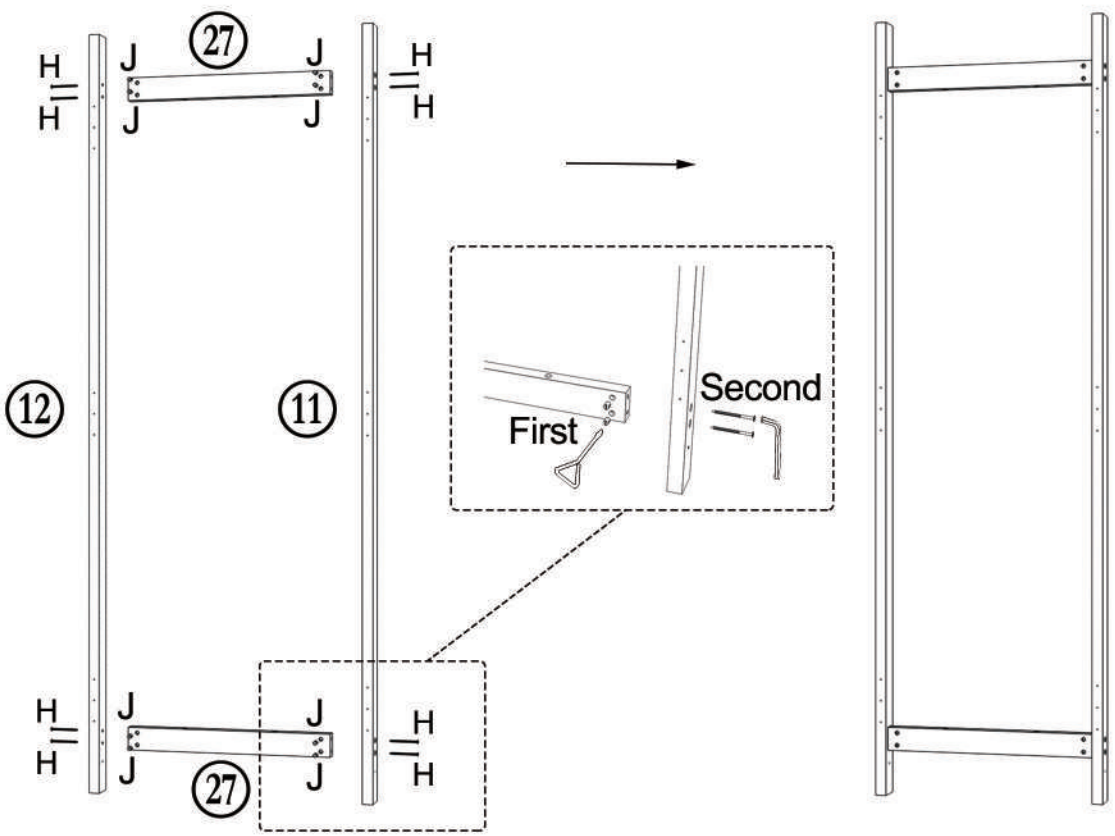

(11)	1
(12)	1
(27)	2
H	M6X60 8
J	M10X13 8
M	M4 1
P	1

F2-1

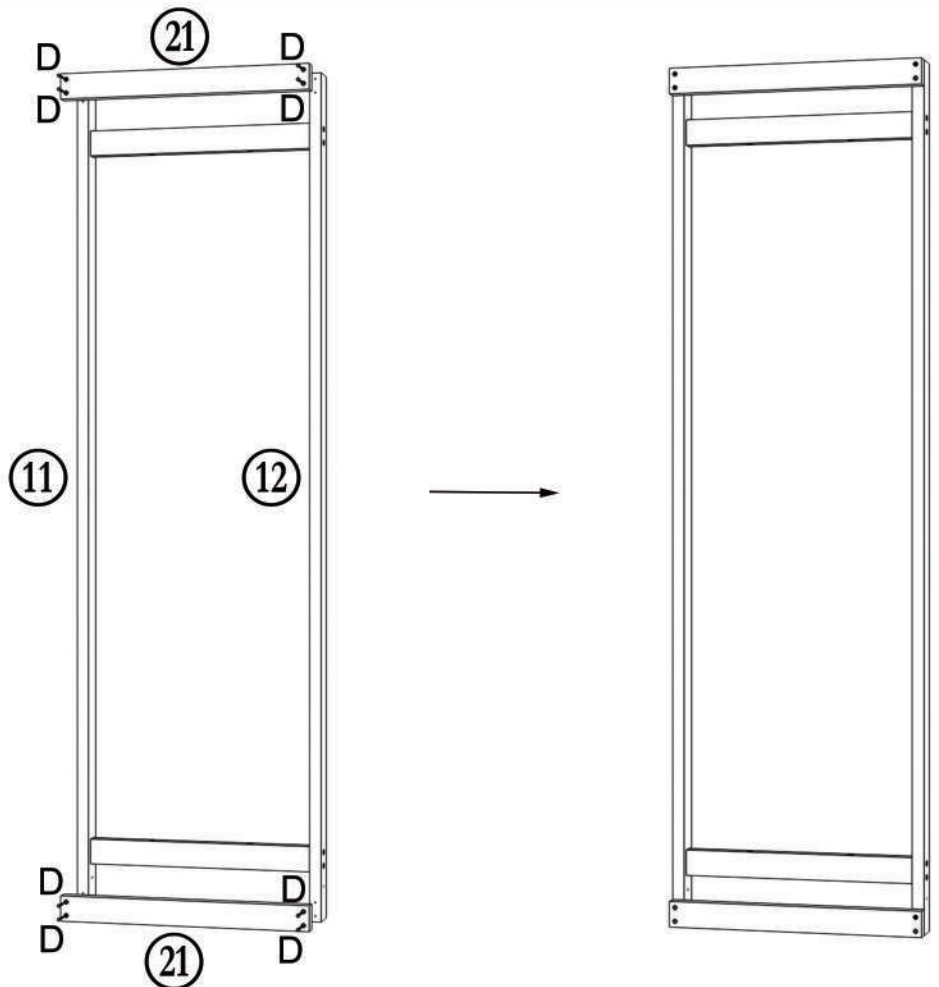

(21)	2
D	M5X50 8



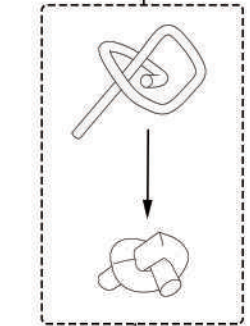
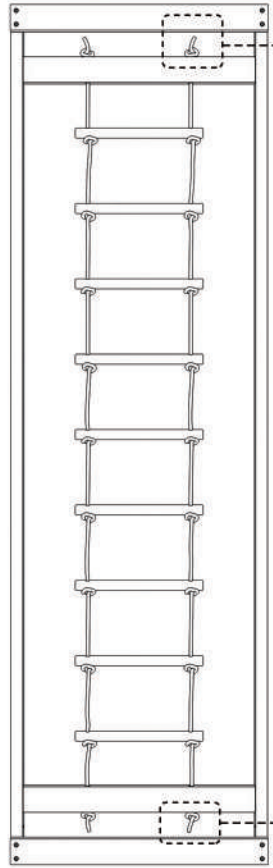
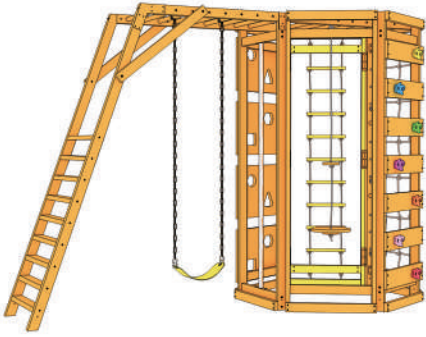
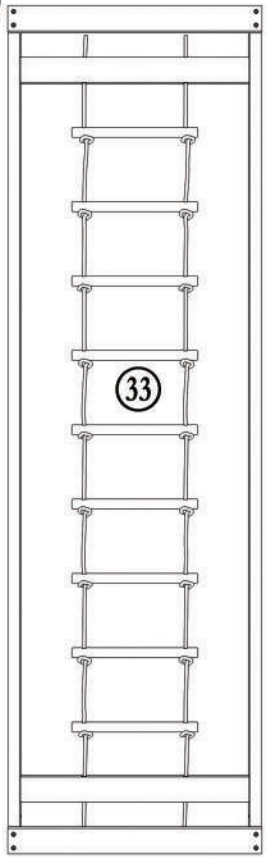

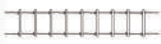
F3-1

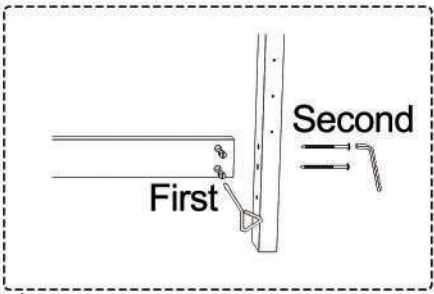
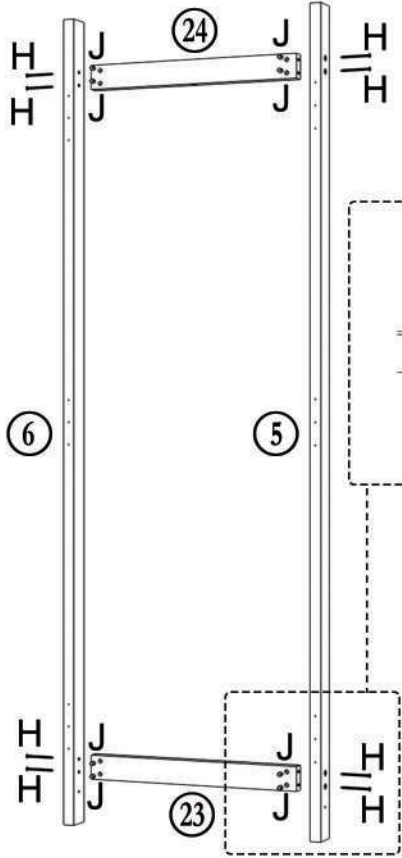

33		1
----	--------------------------------------------------------------------------------------	---

G1-1



5	1	H		8
6	1	J		8
23	1	M		1
24	1	P		1

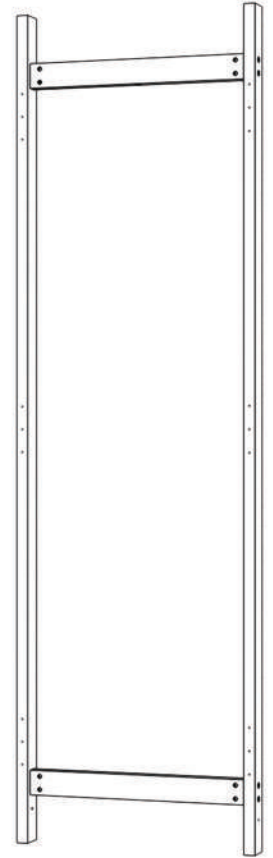

G2-1

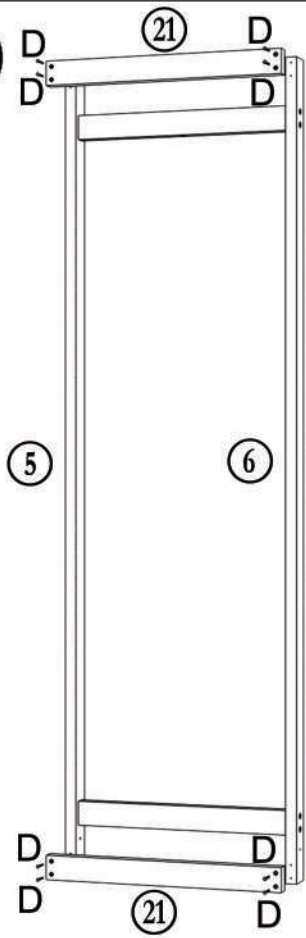

21	2
D	 8
M5X50	

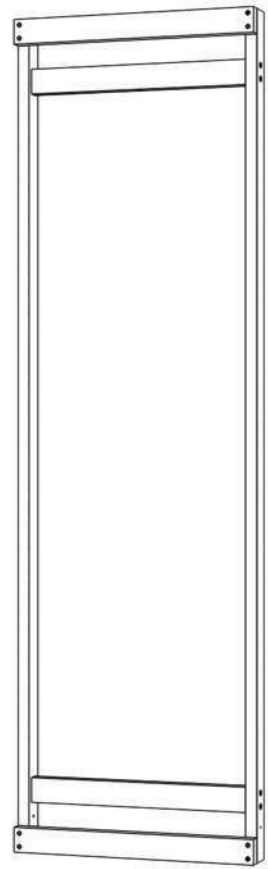

G3-1

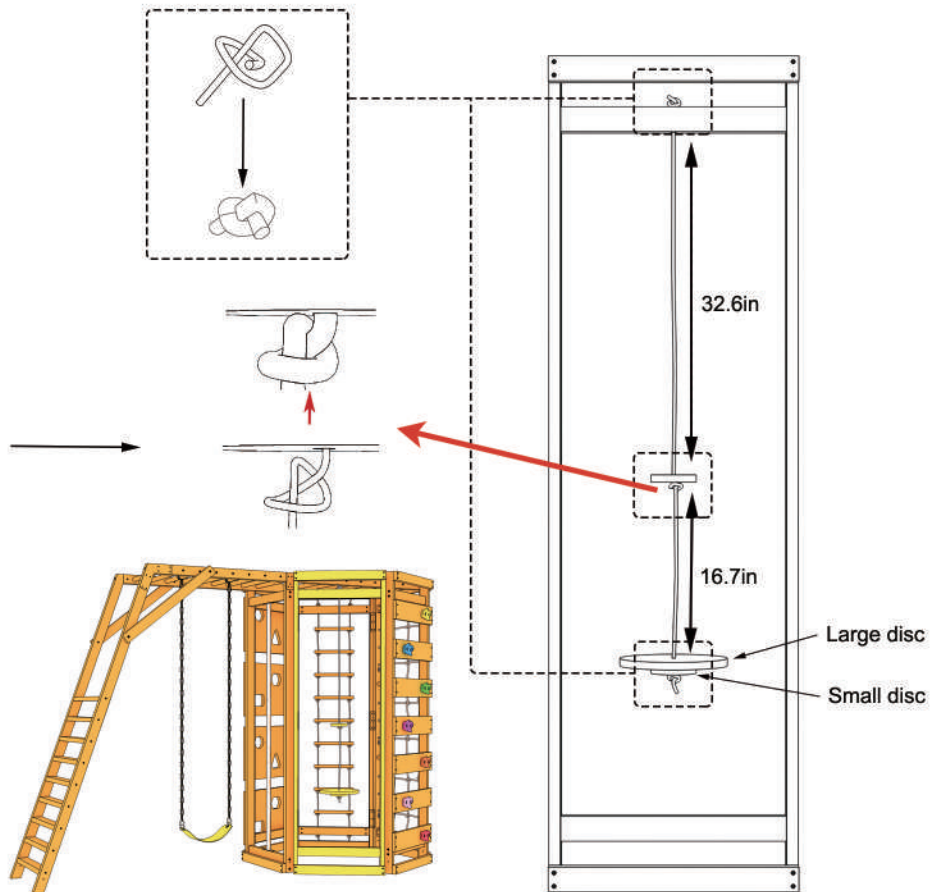
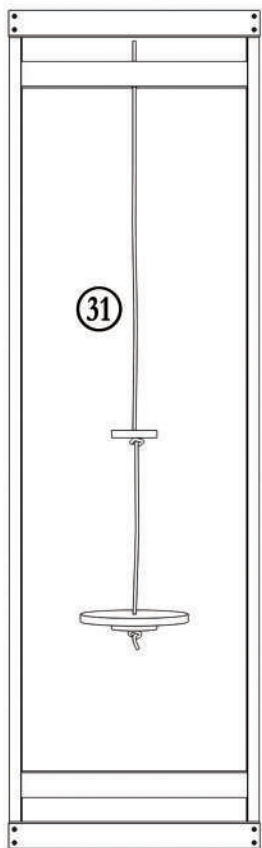

31		1
----	-------------------------------------------------------------------------------------	---

H1-1

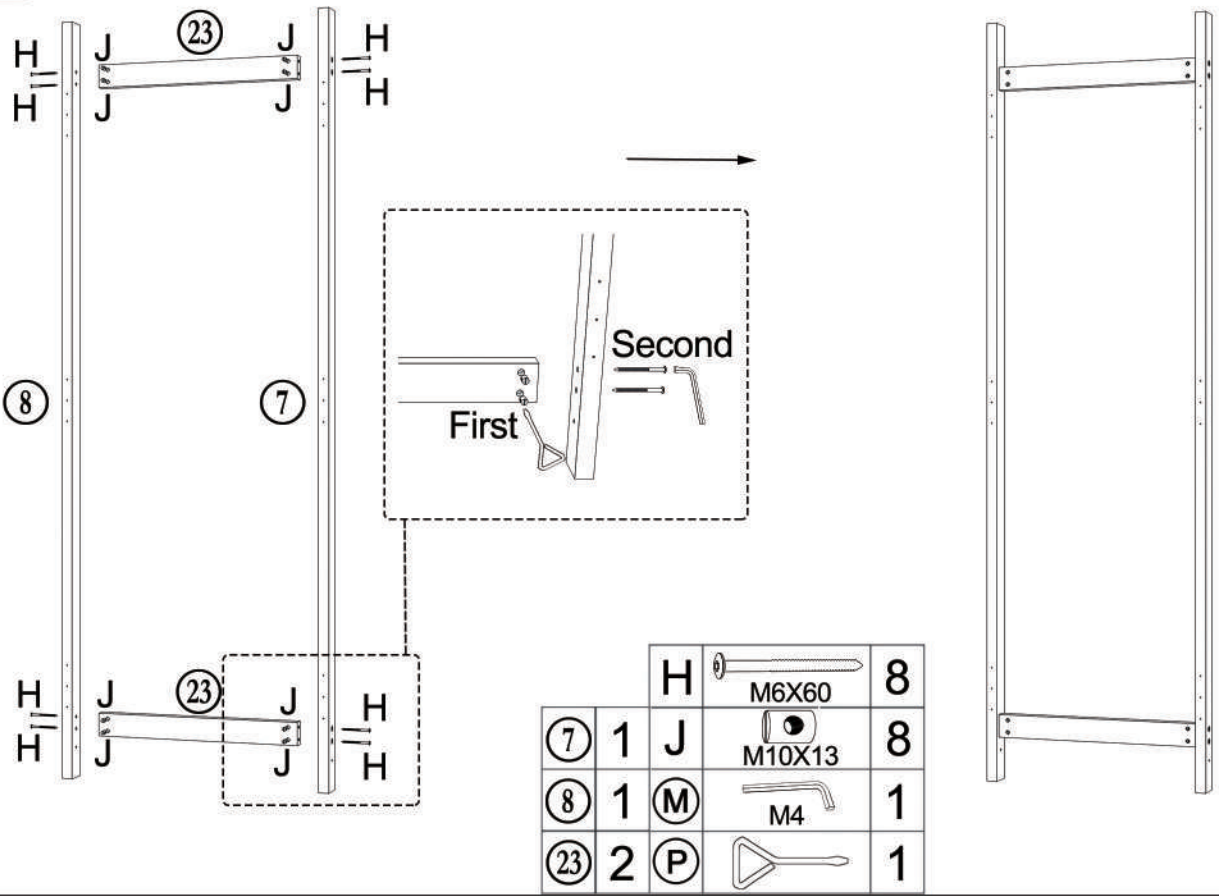

		H		8
		J		8
⑦	1	Ⓜ		1
⑧	1	Ⓜ		1
⑳	2	Ⓟ		1

H2-1

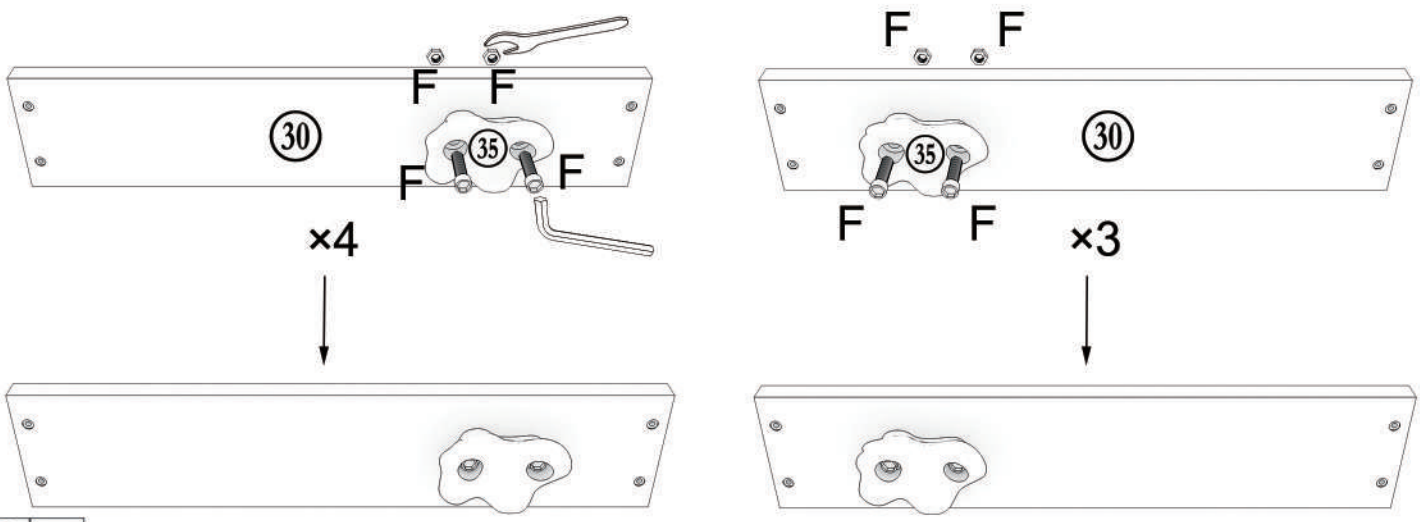

Note: Tighten Screws F



③①	7		
③⑤			7
F		M10X40	14
Ⓝ		M8	1
Ⓞ		M16	1

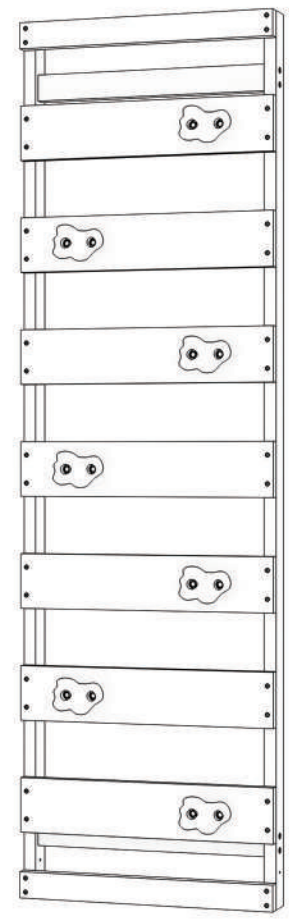
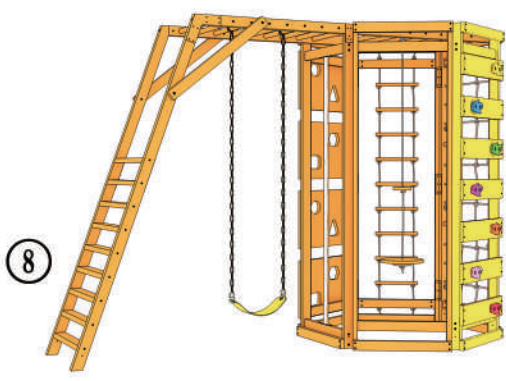
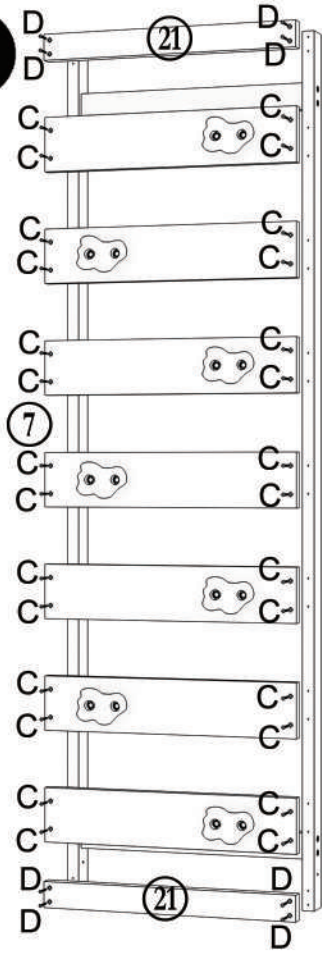

H3-1

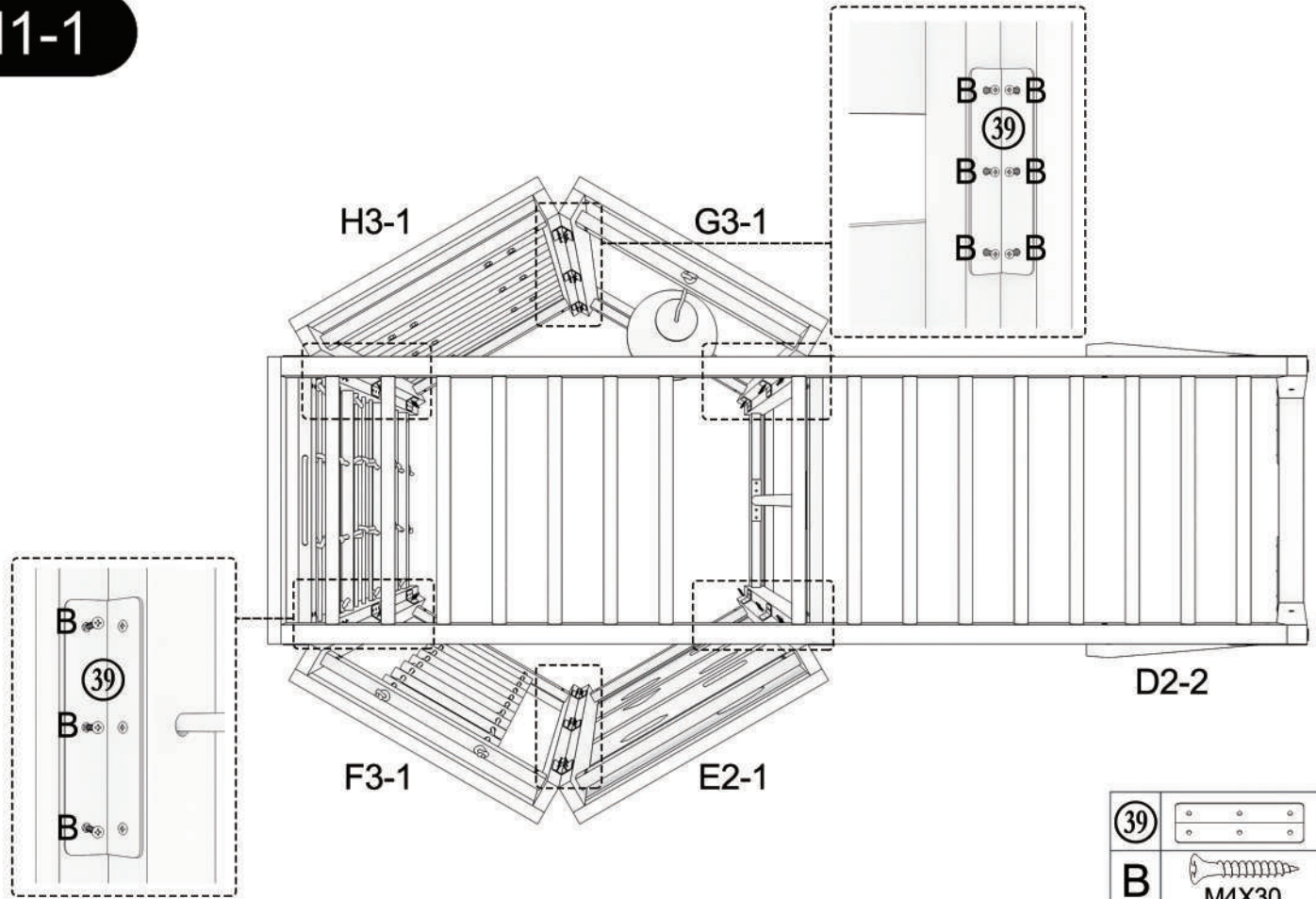

(21)	2		
C		M5X40	28
D		M5X50	8

I1-1



(39)			6
B		M4X30	72

I1-2

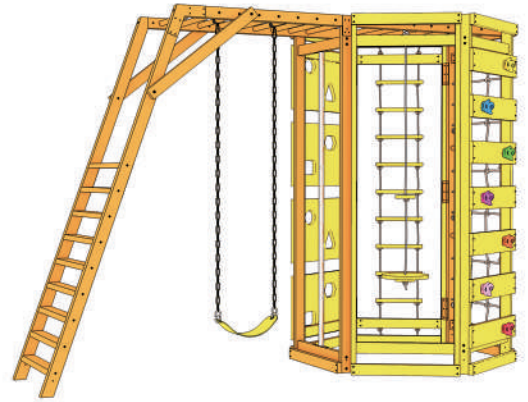
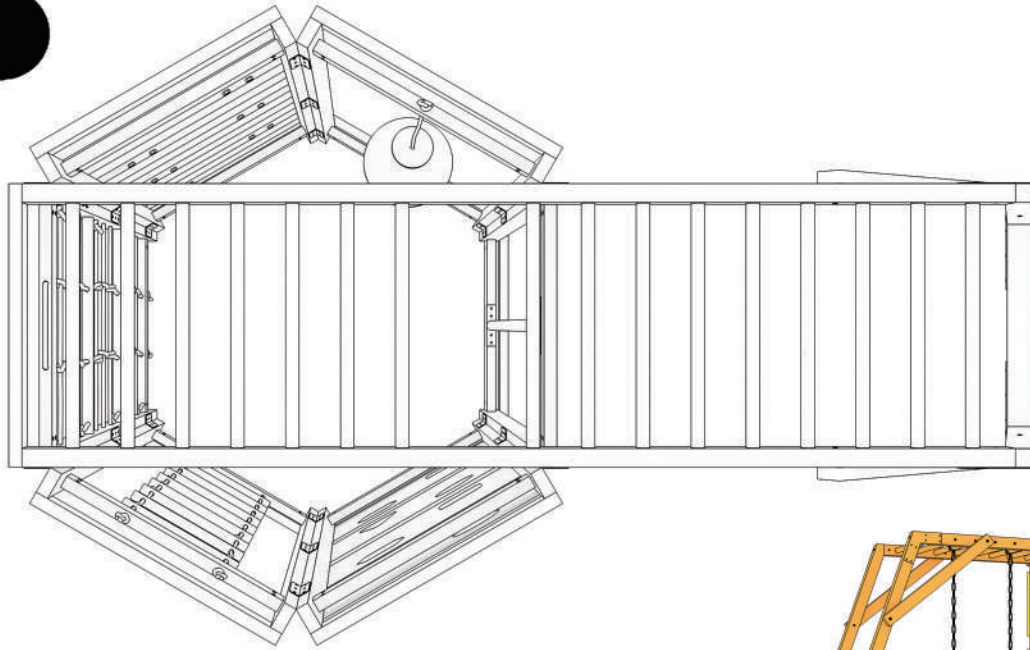

I2-1

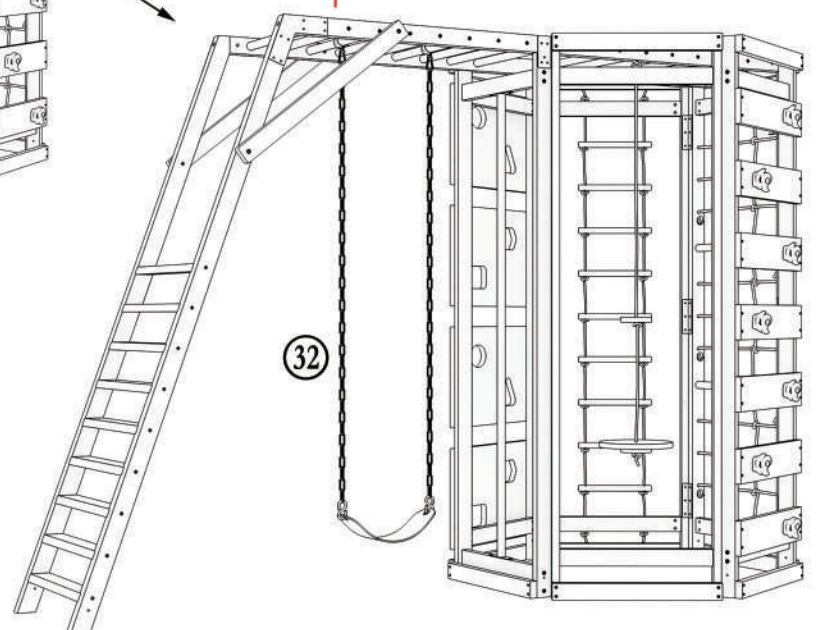
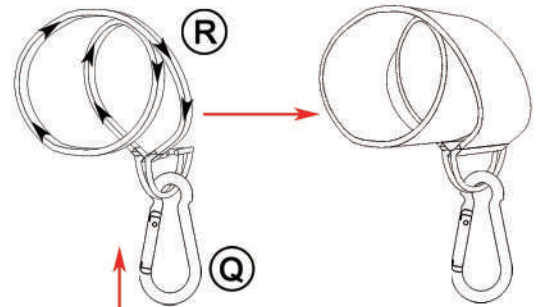
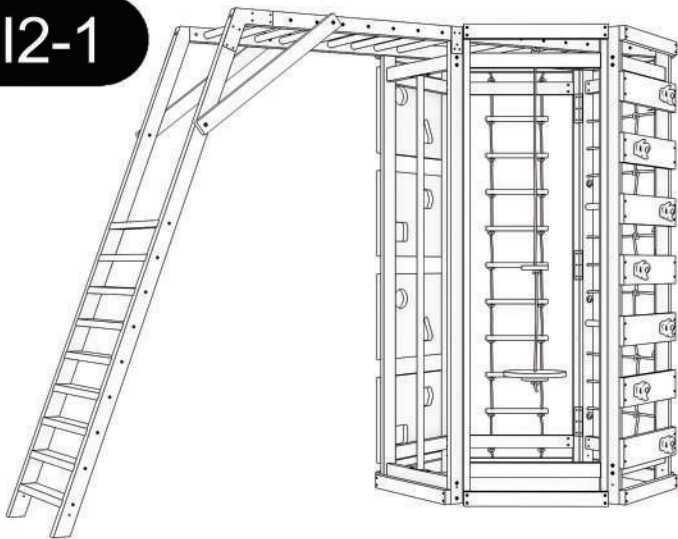

NOTE: The swing is hung from the third and sixth round bars from left to right.

Q		2
R		2
32		1

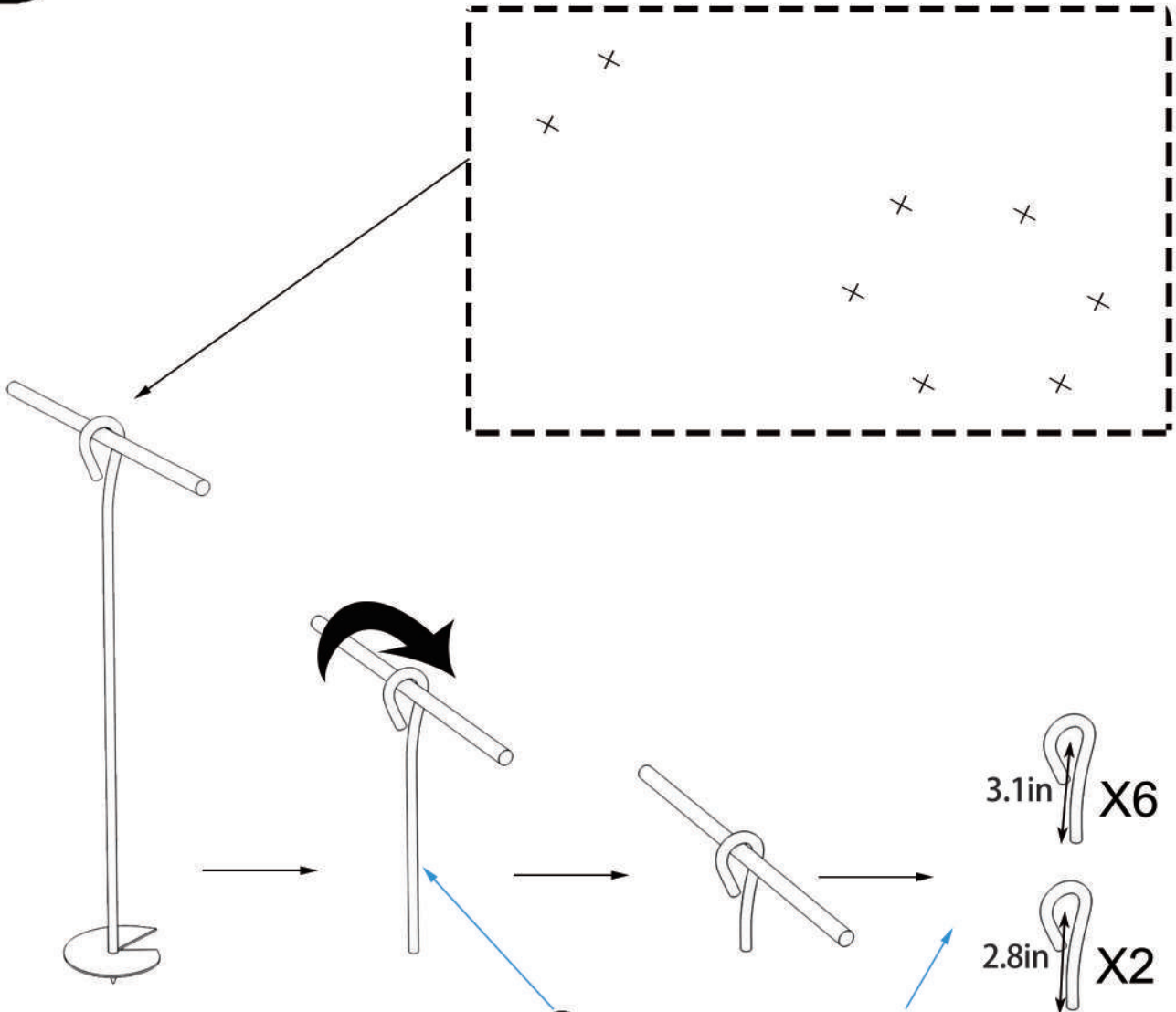

Note: Parts 38 are pushed into underground by a downward clockwise rotation, until the highest point of Parts 38 is 3.1in as shown.

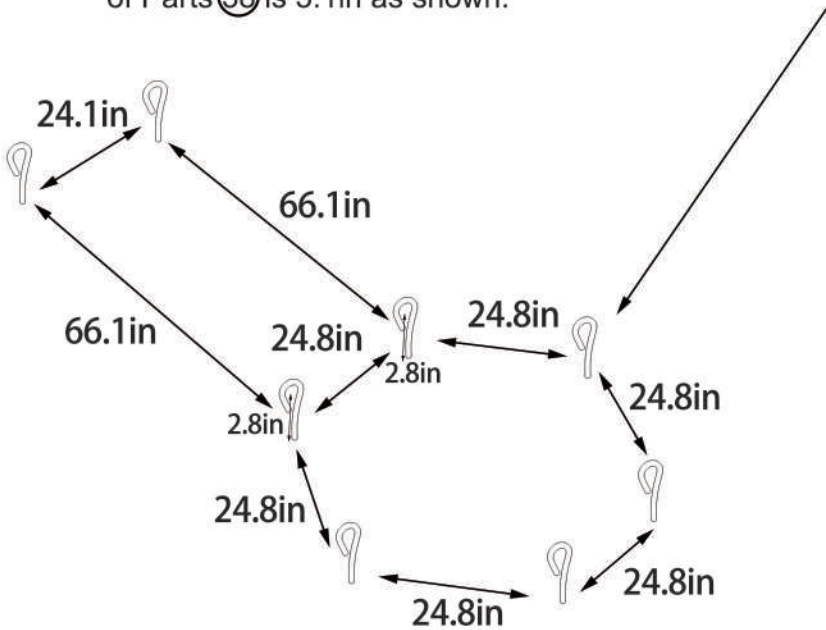

38		8
----	--	---

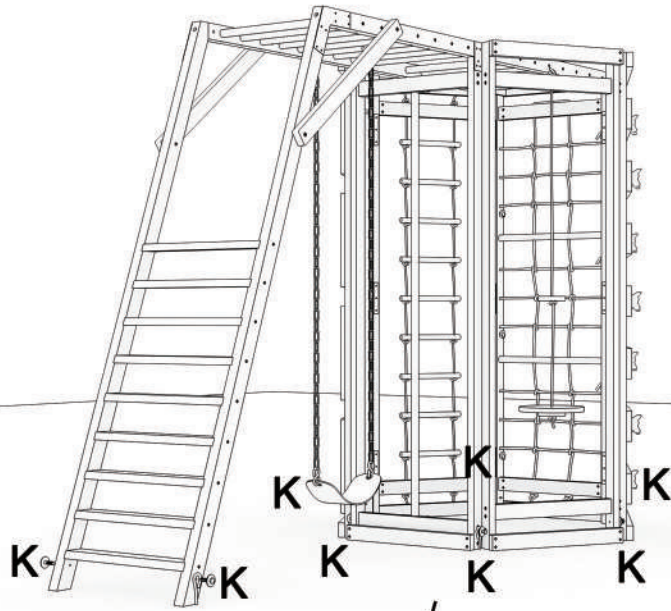

Note: When installing Parts 38 the ground must be flat and compacted, If not , it must be padded to make it flat and compacted.

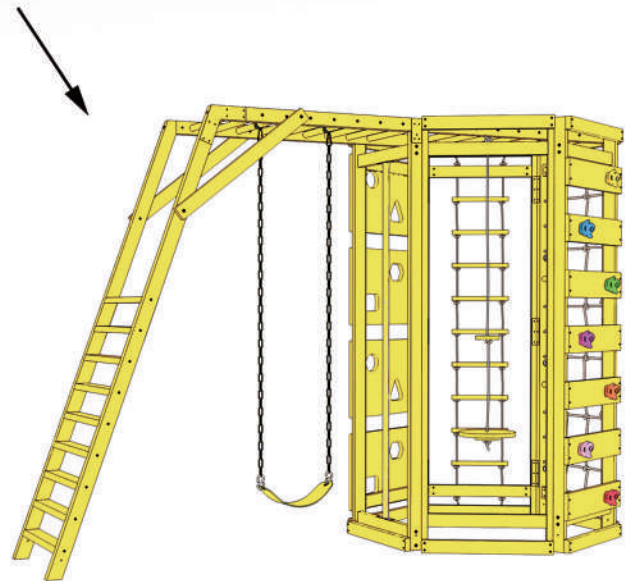
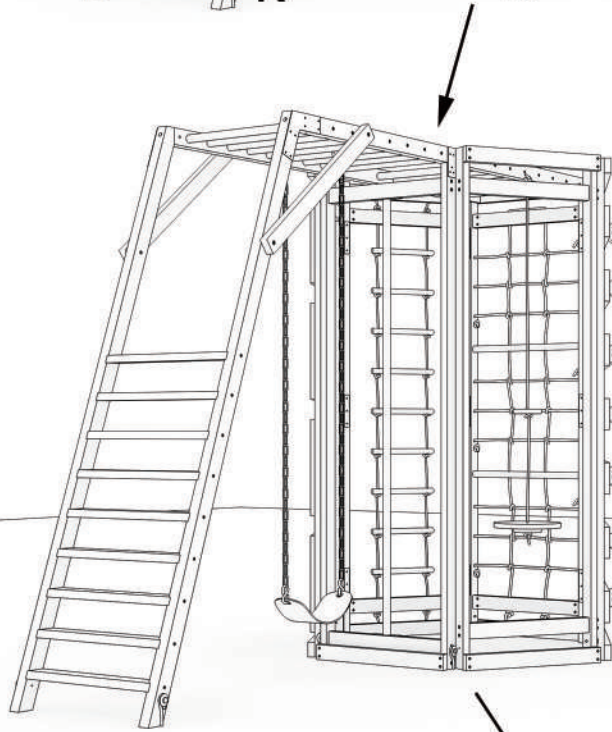

K	 M8×50	8
S		1

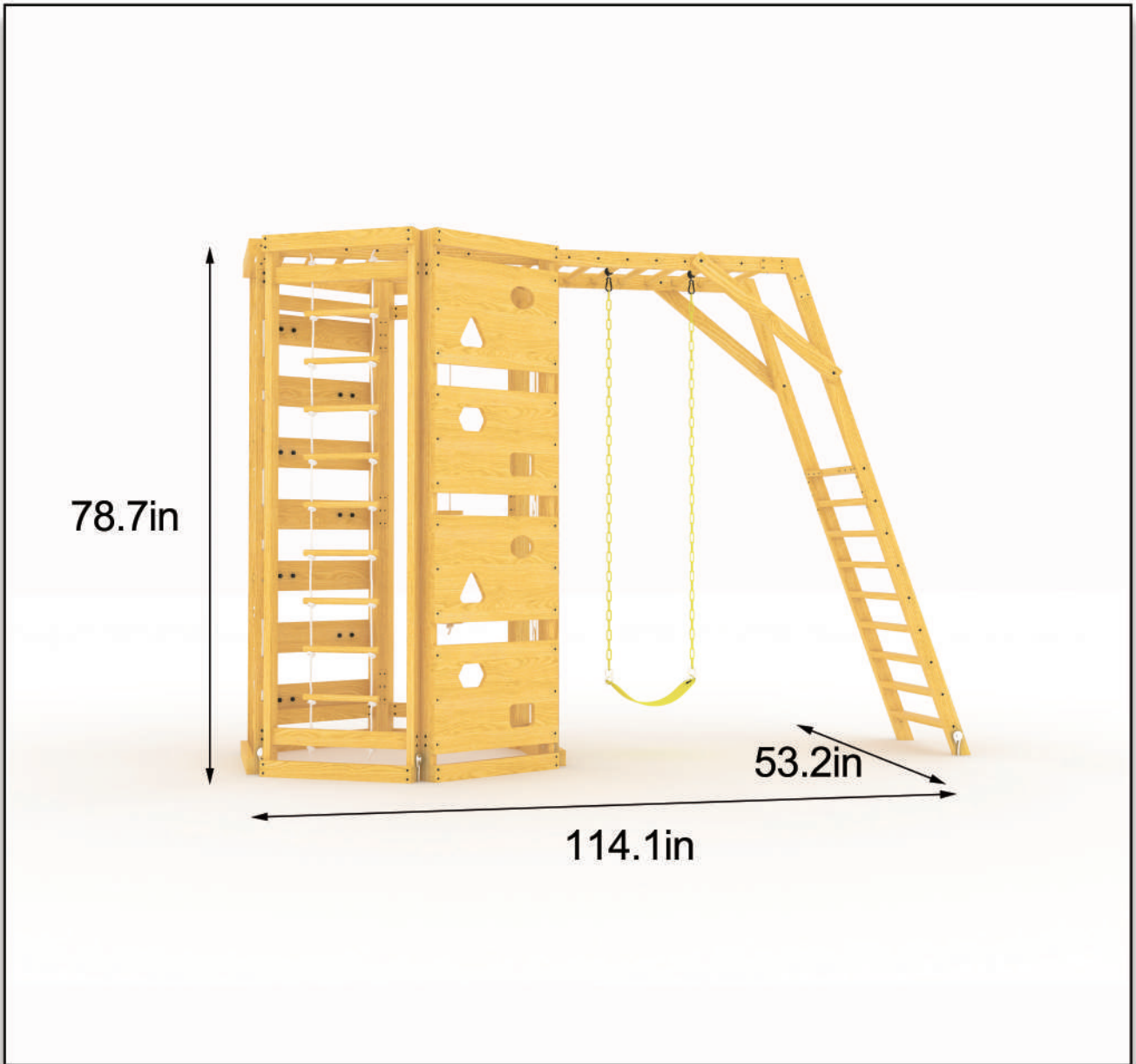

**FOR ADDITIONAL ASSISTANCE
PLEASE CALL US AT 888-697-3931
M-F 9AM-5PM PT (12PM-8PM ET)
OR EMAIL US AT**

info@avenlur.com