

ASSEMBLY, MAINTENANCE, & **USER MANUAL**

MODEL # SJG209



 **WARNING**

Read all precautions and instructions in this manual before using this equipment. Save this manual for future reference.

Ages: 4-8

Maximum occupancy: 2 users

Maximum weight: 162 lbs.



Skywalker Holdings LLC
P.O. Box 574, Brigham City, UT 84302

TABLE OF CONTENTS

Part List.....	3
Part Identification.....	4-5
Exploded Drawing.....	6
Assembly.....	7-18
Installation.....	19
Maintenance & Care Information.....	20
Safety information.....	21
Instructions for Use.....	22
Warning Label Placement.....	23
Playground Surfacing Materials Information.....	24
Limited Warranty.....	25-26



STOP EVERYTHING YOU'RE DOING AND REGISTER YOUR PRODUCT

Find our warranty registration online by typing in: www.skywalkertrampolines.com/registration/

You'll need to have the following information handy:

- Name
- Address
- Phone number
- Date of purchase
- Email address
- Product model number
- Product serial number
- Retailer the product was purchased from

HEY WE'VE GOT SOMETHING REALLY IMPORTANT TO SAY

Check us out online! We've got **assembly videos** (for those of you who prefer movies over books), **FAQs** (so you know you're not the only one who needs help), fascinating **blog posts (5 Tips to Keep Your Kids Active)**, and most importantly, find us on social media! Because we want to be your friend. **We'd love to see how you are using our products!**

Website: skywalkertrampolines.com

Facebook: facebook.com/skywalkertrampolines

YouTube: youtube.com/c/SkywalkerTrampolines

Pinterest: pinterest.com/swtrampolines

Twitter: twitter.com/swtrampolines

Instagram: instagram.com/skywalker_trampolines



WARNING

CHOKING HAZARD- Small parts not for children under 3 years.



WARNING

Adult assembly required.

PART LIST

Key No.	Qty.	Description
1	1	Curved Tube Frame
2	4	Ball Handle Swing
3	2	Gymnast bar
4	2	Free Swinging Ring
5	1	Curved Tube 1
6	2	Upright
7	1	Joint
8	1	Swinging Tube
9	1	Top Frame 1
10	1	Top Frame 2
11	2	M8X65mm Button Bolt
12	12	M8 Locknut
13	32	M8X20mm Button Bolt
14	44	M8 Arc Washer
15	1	Curved Tube 2
16	2	Curved Tube Frame 2
17	1	Hex Key
18	1	Wrench
19	2	Anchor
20	1	M8 Washer
#	1	User's Manual

ORDERING REPLACEMENT PARTS

We get it, sometimes things happen, but the fun shouldn't stop just because you need a new bolt or screw. To order replacement parts, check out our website at: www.skywalkertrampolines.com or call our toll-free Customer Care Hot-line at **1-866-603-Jump (5867)**, Monday - Thursday 8 a.m. to 5 p.m., Friday 8 a.m. to 3 p.m. (excluding holidays).

Our customer service team will ask you a few questions in order to get the replacement part sent out as soon as possible. We're not trying to complicate your life, we promise.

When calling, make sure to have the following information ready:

- The model # of the product (see the front cover of this manual)
- The key # and description of the part (see the part list above)
- The quantity of parts needed (only you know the answer to that one)

BEFORE YOU BEGIN

Thanks for choosing ActivPlay! We're just as excited as you are to help your family live an active (but most importantly **FUN**) lifestyle. This model is one of our favorites, and we're confident you'll love it too. We want to make things easier for you, so we have listed all the important information that you (and your little outdoor adventurers) need to know. Make sure you brush up on the warnings, instructions, assembly, maintenance, and use of your new product, because there will be a pop quiz at the end (Okay, not **REALLY**, but if you're still reading this, props to you! You're awesome.).

PART IDENTIFICATION

Before you begin, take a look at the drawings below to make sure you have all the parts. The numbers in the squares to the left (key numbers) will help you identify the parts during assembly.

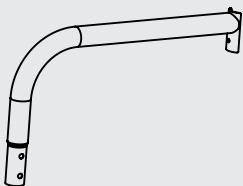

1 Curved Tube Frame (x1)

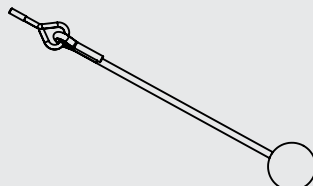

2 Ball Handle Swing (x4)

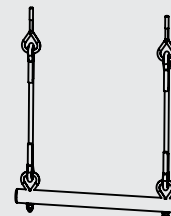

3 Gymnast Bar (x2)

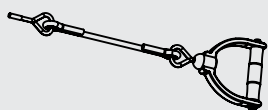

4 Free Swinging Ring (x2)

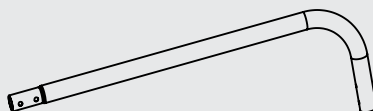

5 Curved Tube 1 (x1)

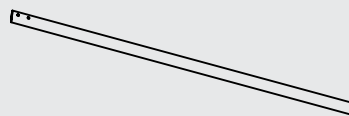

6 Upright (x2)

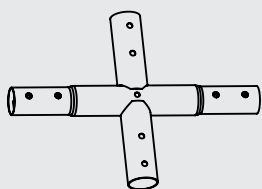

7 Joint (x1)

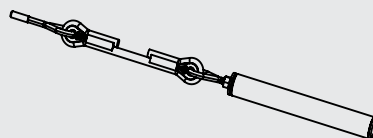

8 Swinging Tube (x1)

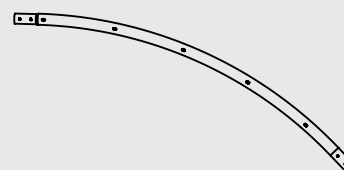

9 Top Frame 1 (x1)

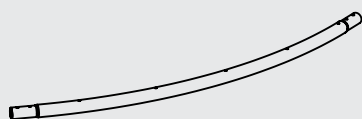

10 Top Frame 2 (x1)

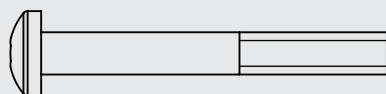

11 M8X65mm Button Bolt (x2)

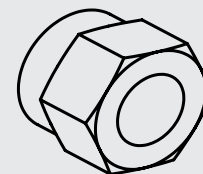

12 M8 Locknut (x12) (11 pre-installed)

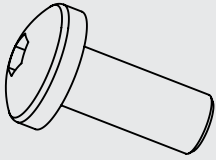

13 M8X20mm Button Bolt **(x32)**



14 M8 Arc Washer **(x44)**
(11 pre-installed)

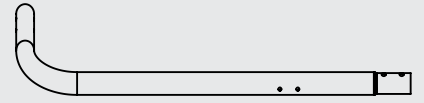

15 Curved Tube 2 **(x1)**

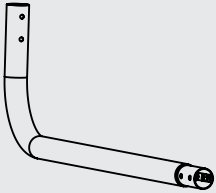

16 Curved Tube Frame 2 **(x2)**

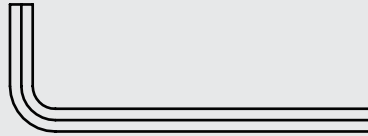

17 Hex Key **(x1)**

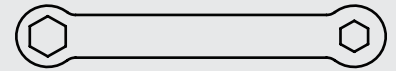

18 Wrench **(x1)**

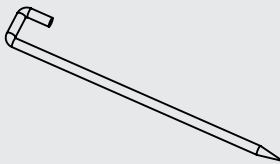

19 Anchor **(x2)**

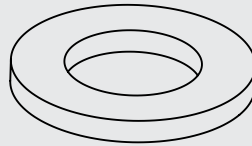

20 M8 Washer **(x1)**

EXPLODED DRAWING

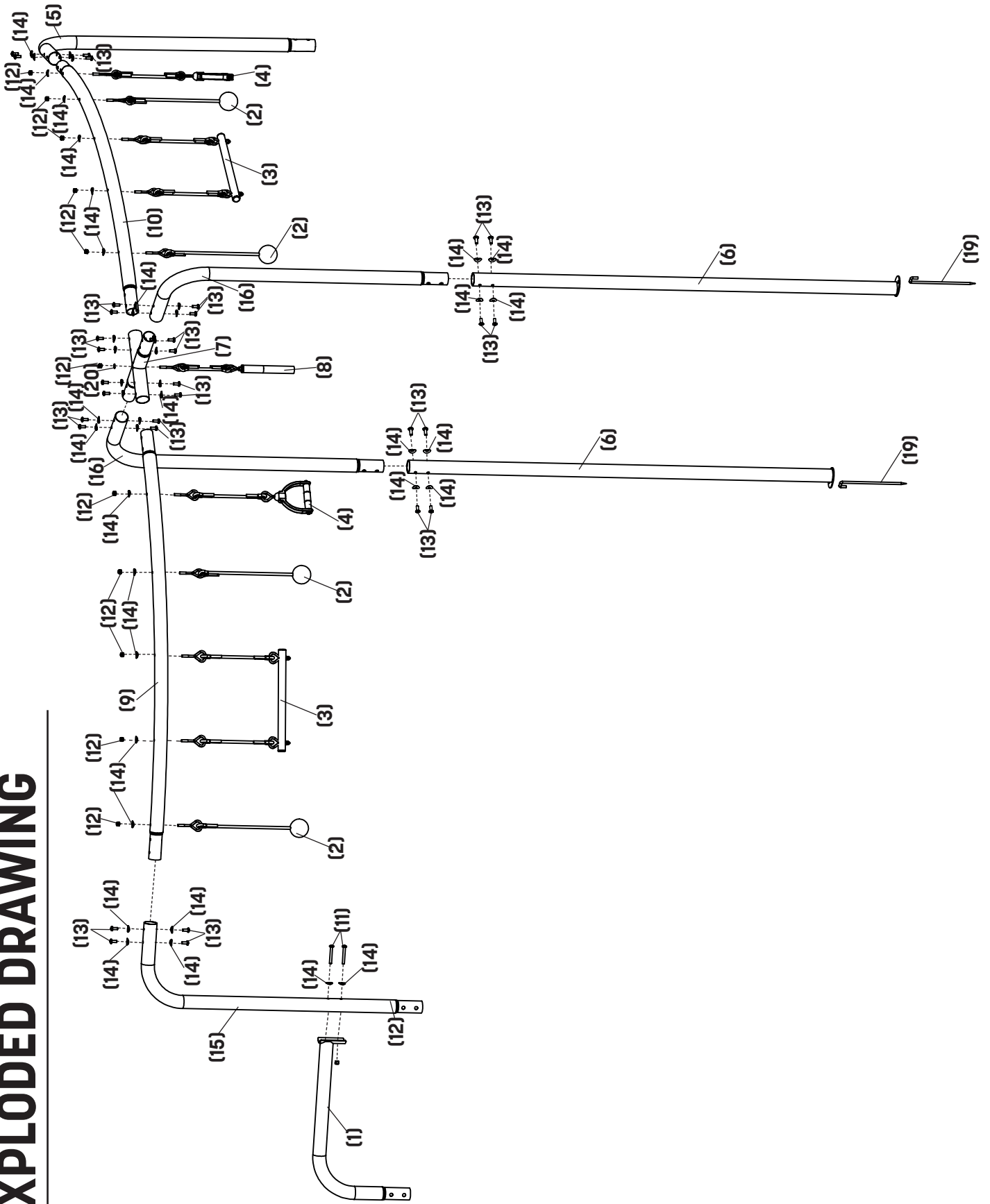

ASSEMBLY

READ THIS BEFORE YOU BEGIN

- We've provided some tools to help with assembly, but you're more than welcome to use your own
- The assembly steps refer to parts by their descriptions and key numbers (see the part list on page 3)
- The assembly steps are written in a specific order, and if you don't follow them exactly, you may end up having to start all over again
- Most importantly, this may not be the easiest thing you've ever done, but it will be **worth it**. Trust us.

STEP 1

Register your Hanging Jungle Line. For info on **warranty registration**, see page 2.

STEP 2

In order to attach the Hanging Jungle Line to your jungle gym, you may need to adjust the position of your hanging bridge and monkey bars. When facing your jungle gym, the hanging bridge will need to sit in the middle of the side facing you and the monkey bars will need to sit in the middle of the side to the right of you. See the image below for an example.

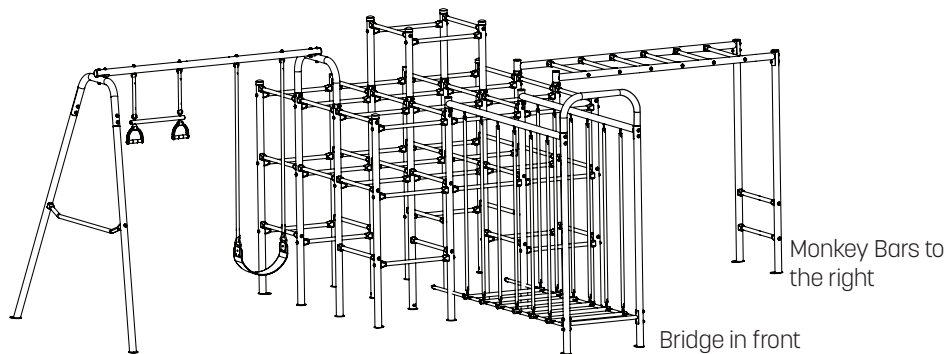

STEP 3

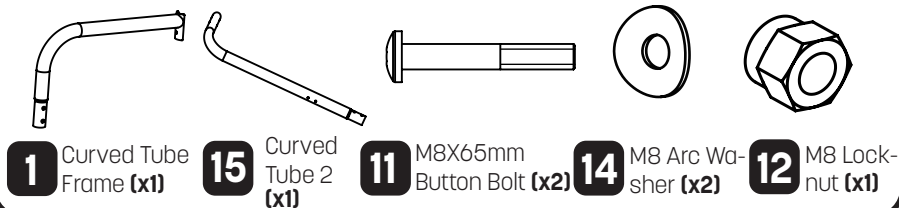

To begin, connect the Curved Tube Frame **(1)** to the Curved Tube 2 **(15)** as shown below with the two M8X65mm Button Bolts **(11)**, two M8 Arc Washers, using **(14)** the M8 Locknut **(12)** on the bottom bolt.

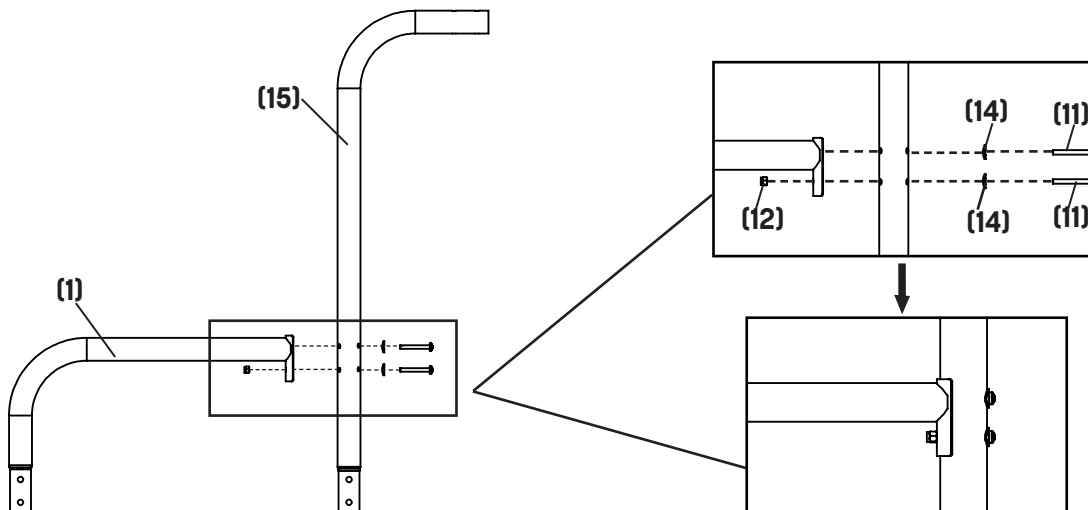

ASSEMBLY

STEP 4

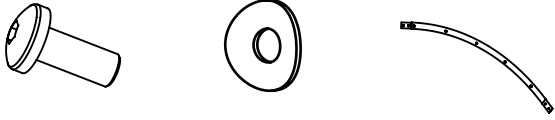

- 13** M8X20mm Button Bolt (x4) **14** M8 Arc Washer (x4) **9** Top Frame 1 (x1)

Now, attach the Curved Tube 2 (15) from the previous step to the *smaller side* of the Top Frame 1 (9). *The round holes in the Top Frame 1 (9) should be facing up.* Use four M8x20mm Button Bolts (13) and four M8 Arc Washers (14) to secure.

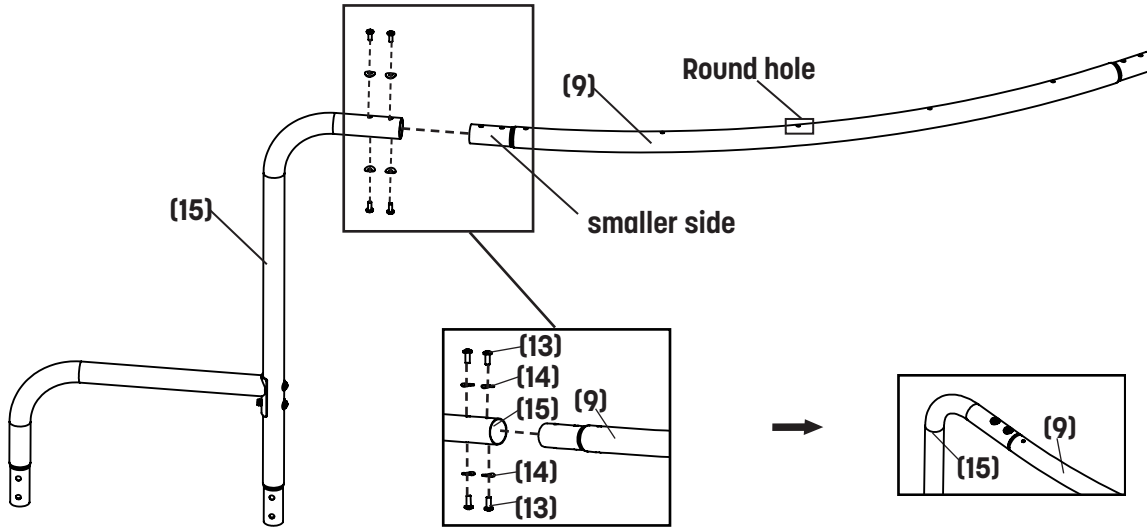

STEP 5

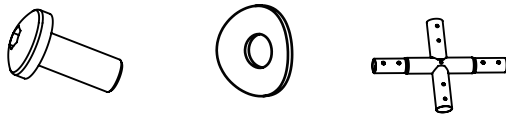

- 13** M8X20mm Button Bolt (x4) **14** M8 Arc Washer (x4) **7** Joint (x1)

Connect a shorter side of the Joint (7) to the free end of the Top Frame 1 (9) with four M8X20mm Button Bolts (13) and four M8 Arc Washers (14) as shown. *Make sure the round hole in the middle of the joint is facing up.*

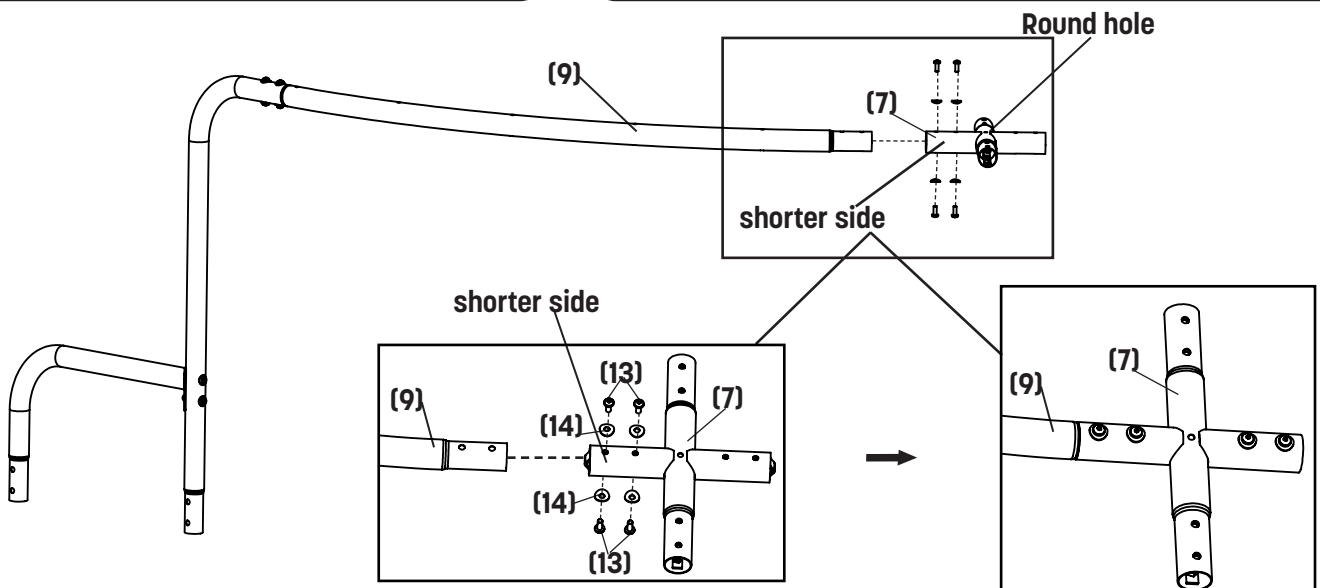

STEP 6

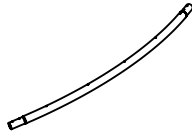
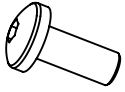

13 M8X20mm
Button Bolt (x4)

14 M8 Arc Wash-
er (x4)

10 Top Frame
2 (x1)

Now connect the Top Frame 2 **(10)** to the Joint **(7)** on the remaining short side with four M8X20mm Button Bolts **(13)** and four M8 Arc Washers **(14)** as shown. *The round holes in the Top Frame 2 **(10)** should be facing up.*

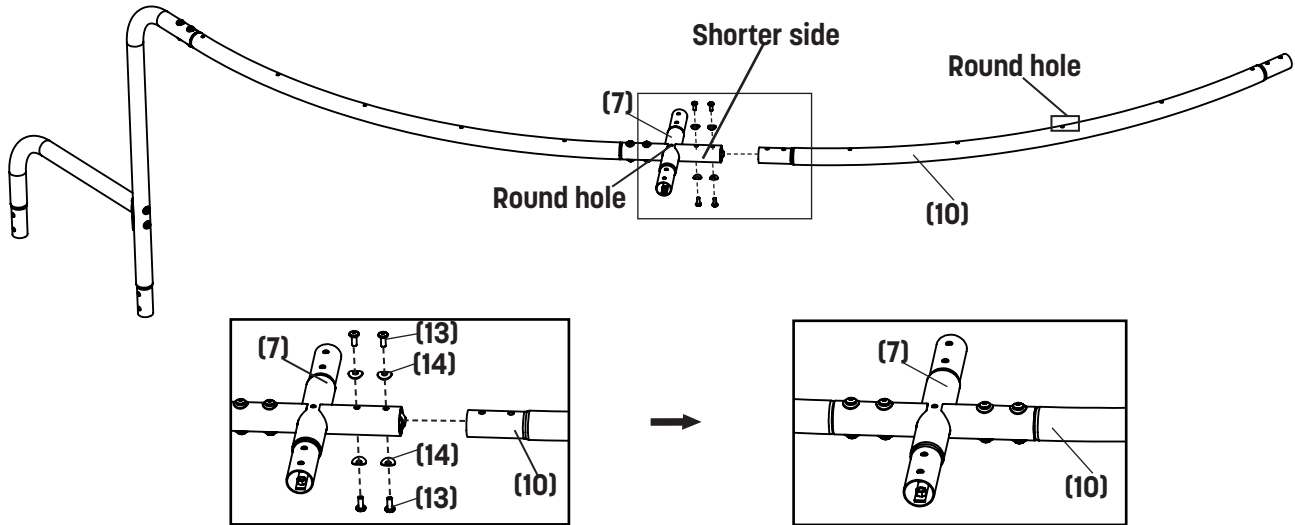

STEP 7

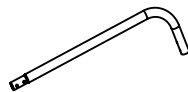
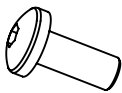

13 M8X20mm
Button Bolt (x4)

14 M8 Arc Wash-
er (x4)

5 Curved
Tube1 (x1)

Attach the Curved Tube 1 **(5)** to the free side of the Top Frame 2 **(10)** with four M8X20mm Button Bolts **(13)** and four M8 Arc Washers **(14)** as shown.

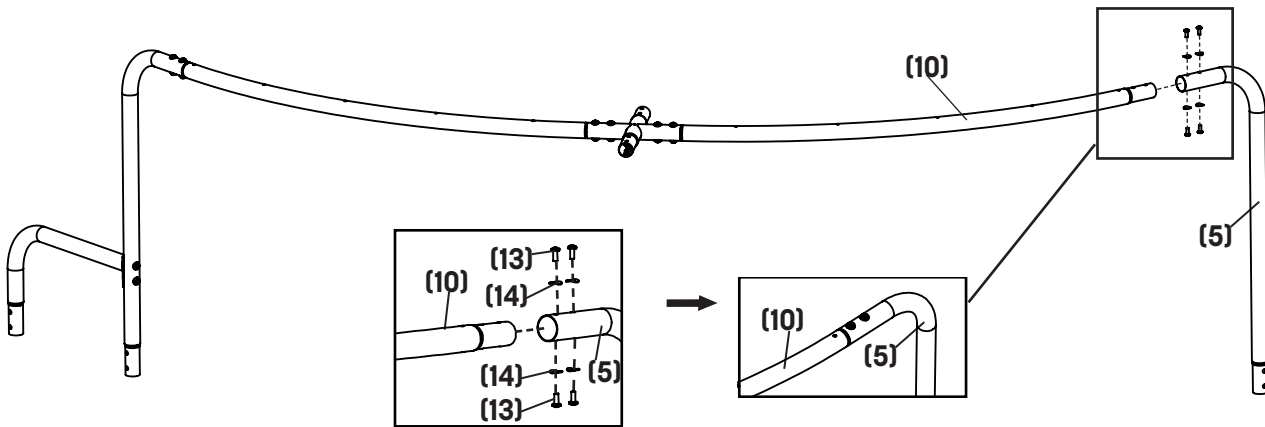

ASSEMBLY

STEP 8

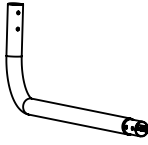
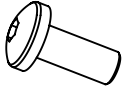

13 M8x20mm
Button Bolt (x8)

14 M8 Arc Wash-
er (x8)

16 Curved Tube
Frame 2 (x2)

Attach Curved Tube Frame 2 (16) to each free end of the Joint (7). Secure each tube with four M8x20mm Button Bolts (13) and four M8 Arc Washers (14) as shown (a total of eight M8x20mm Bolts and eight M8 Arc Washers will be used.)

At this point in assembly, the hanging jungle line should be able to stand on its own.

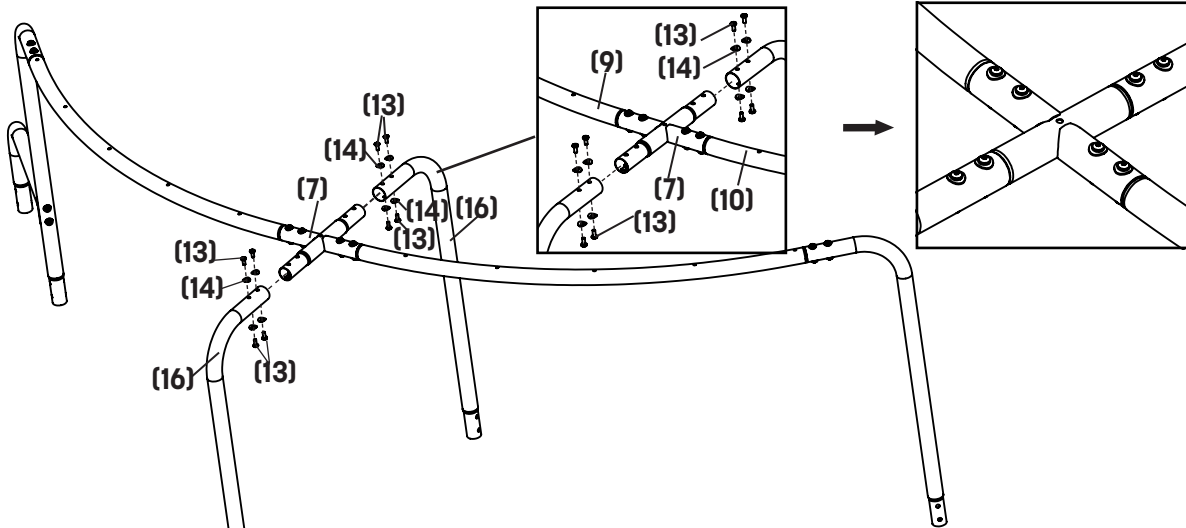

STEP 9

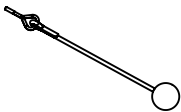

2 Ball Handle
Swing (x1)

14 M8 Arc Washer
(x1)

12 M8 Lock-
nut (x1)

Attach a Ball Handle Swing (2) in the location shown below by sliding it up through the bottom of the Top Frame 1 (9) and securing at the top with a M8 Arc Washer (14) and a M8 Locknut (12) as shown.

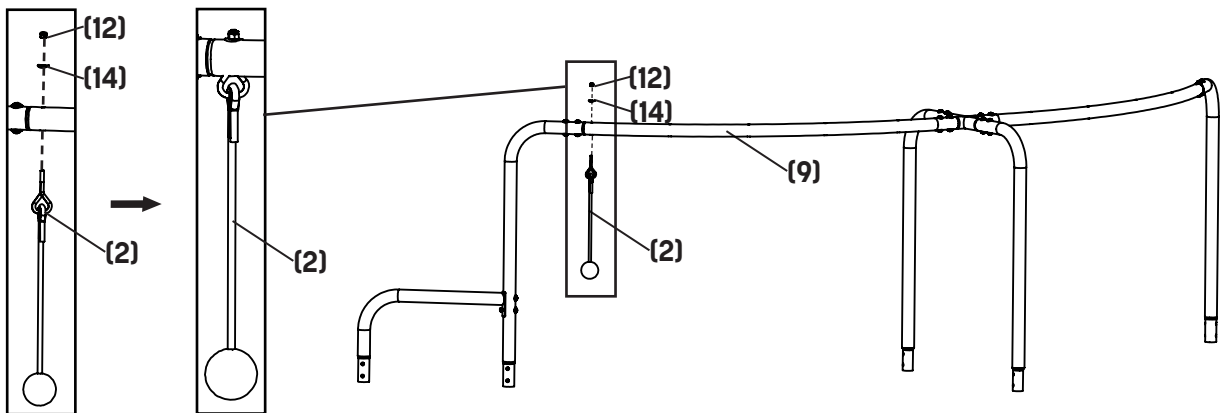

STEP 10



Now attach a Gymnast Bar **(3)** next to the ball handle swing **(2)** you just placed on the Top Frame **(9)**. Use two M8 Arc Washers **(14)** and two M8 Locknuts **(12)** to secure.

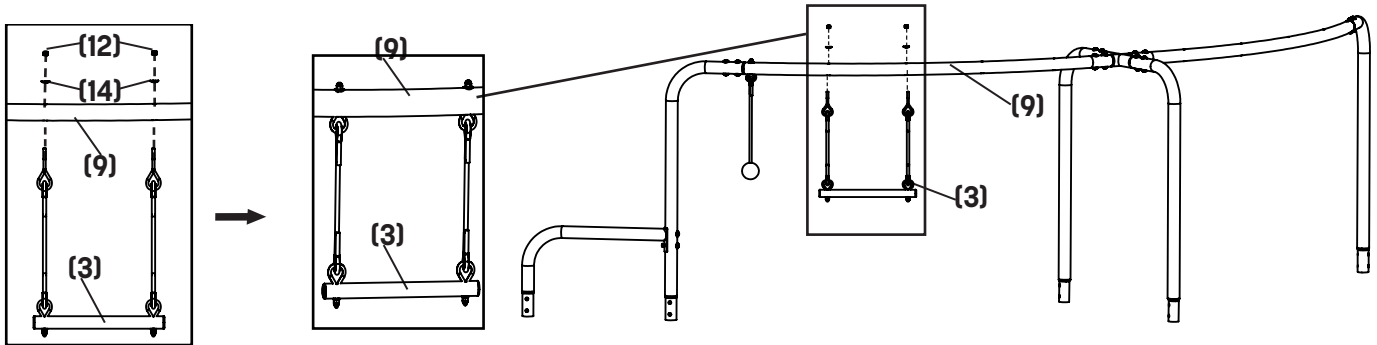

STEP 11



Attach another Ball Handle Swing **(2)** to the Top Frame **(9)** with a M8 Arc Washer **(14)** and a M8 Locknut **(12)** as shown.

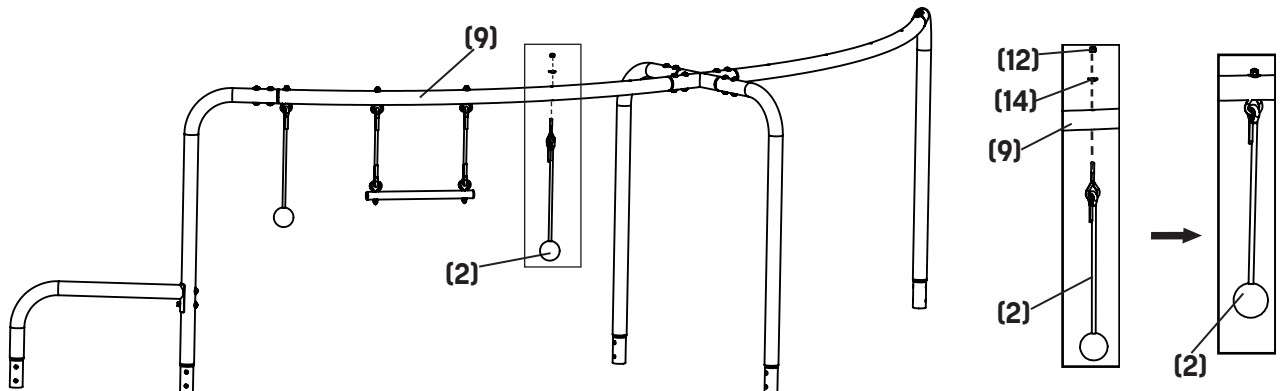

ASSEMBLY

STEP 12

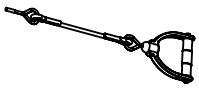

4 Free Swinging Ring (x1)



14 M8 Arc Washer (x1)



12 M8 Locknut (x1)

Now, attach a Free Swinging Ring **(4)** to the Top Frame **(9)** with the M8 Arc Washer **(14)** and a M8 Locknut **(12)** as shown.

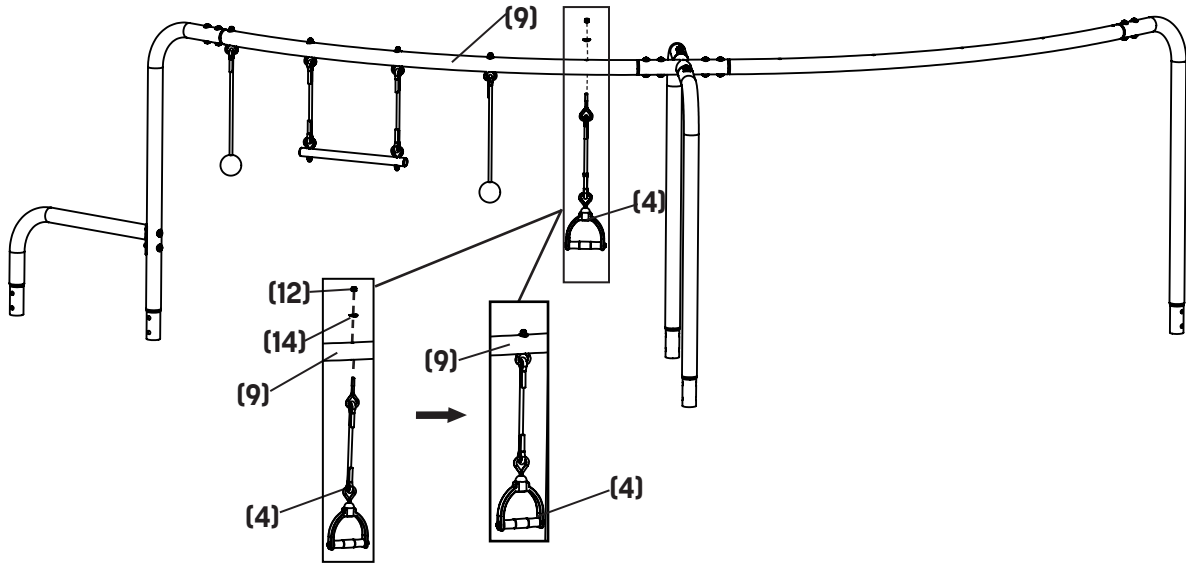

STEP 13

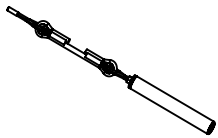

8 Tube Swinging Ring (x1)

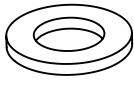

20 M8 Washer (x1)



12 M8 Locknut (x1)

Attach the Swinging Tube **(8)** to the Joint **(7)** with the M8 Washer **(20)** and the M8 Locknut **(12)** as shown.

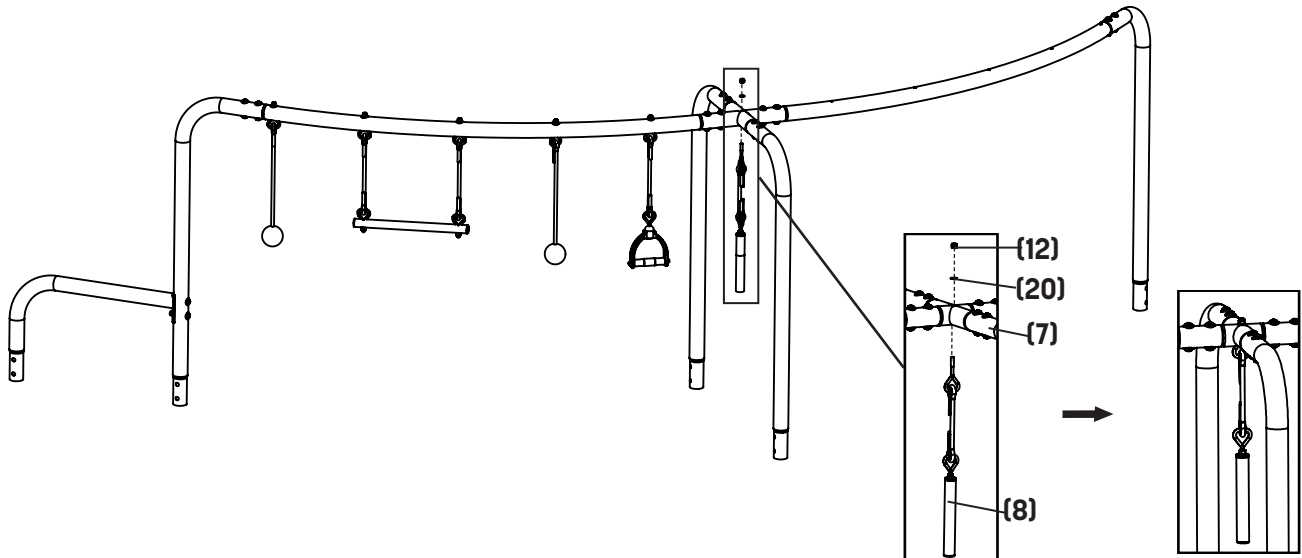

STEP 14

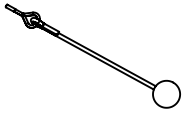

2 Ball Handle Swing (x1)



14 M8 Arc Washer (x1)



12 M8 Locknut (x1)

Attach another Ball Handle Swing **(2)** to the Top Frame 2 **(10)** with the M8 Arc Washer **(14)** and the M8 Locknut **(12)** as shown.

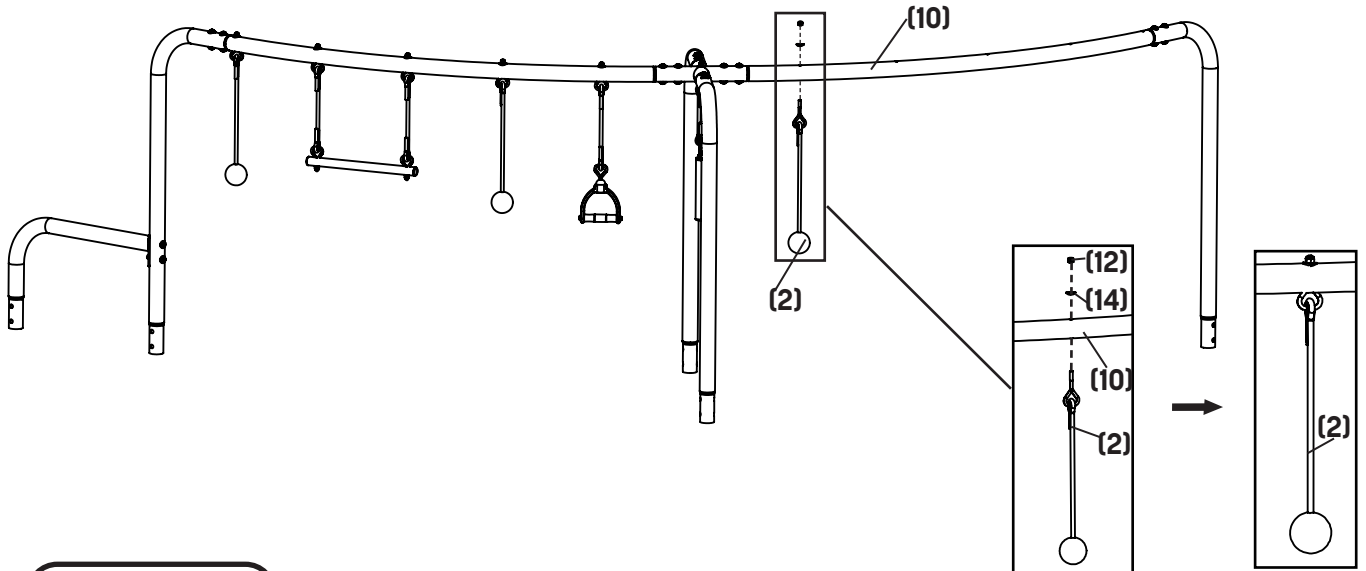

STEP 15

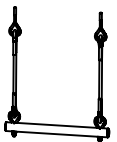

3 Gymnast Bar (x1)



14 M8 Arc Washer (x2)



12 M8 Locknut (x2)

Attach a Gymnast Bar **(3)** to the Top Frame 2 **(10)** with two M8 Arc Washers **(14)** and two M8 Locknuts **(12)** as shown.

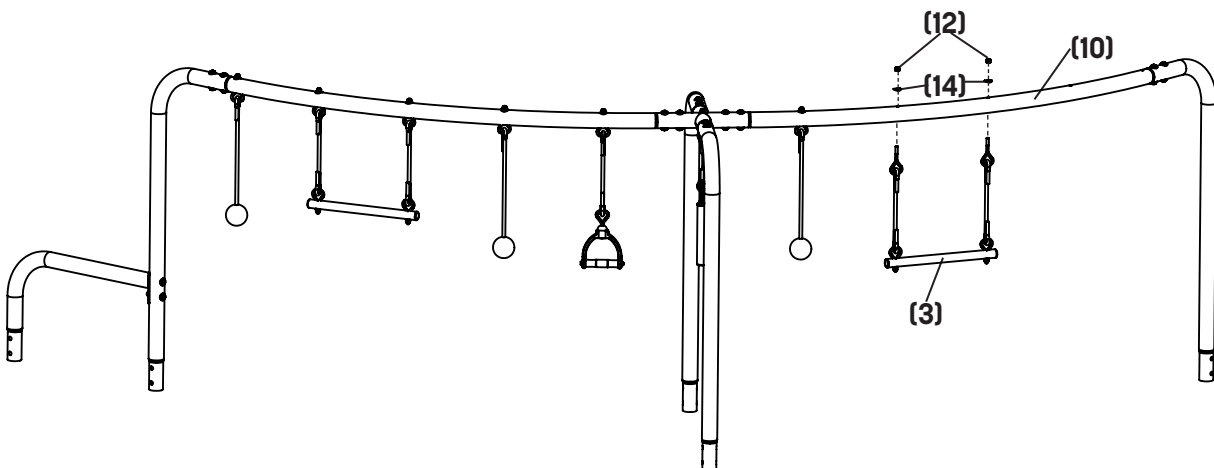

ASSEMBLY

STEP 16

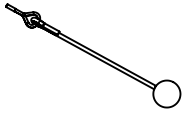

2 Ball Handle Swing (x1)



14 M8 Arc Washer (x1)



12 M8 Locknut (x1)

Now attach the last Ball Handle Swing **(2)** to the Top Frame 2 **(10)** with the M8 Arc Washer **(14)** and the M8 Locknut **(12)** as shown.

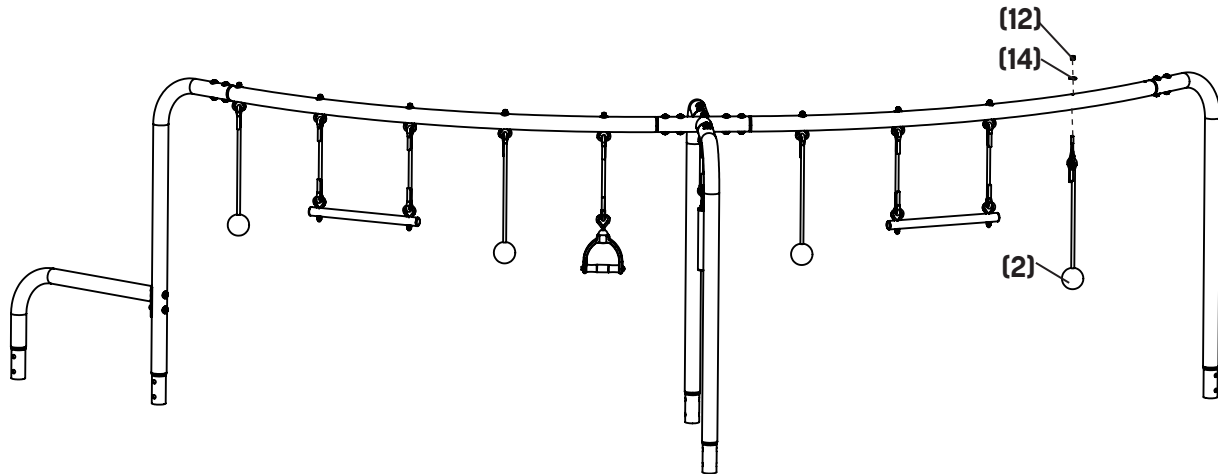

STEP 17



4 Free Swinging Ring (x1)



14 M8 Arc Washer (x1)



12 M8 Locknut (x1)

Finally, attach the second Free Swinging Ring **(4)** to the Top Frame 2 **(10)** with the M8 Arc Washer **(14)** and the M8 Locknut **(12)** as shown.

Now, all the hanging pieces are installed.

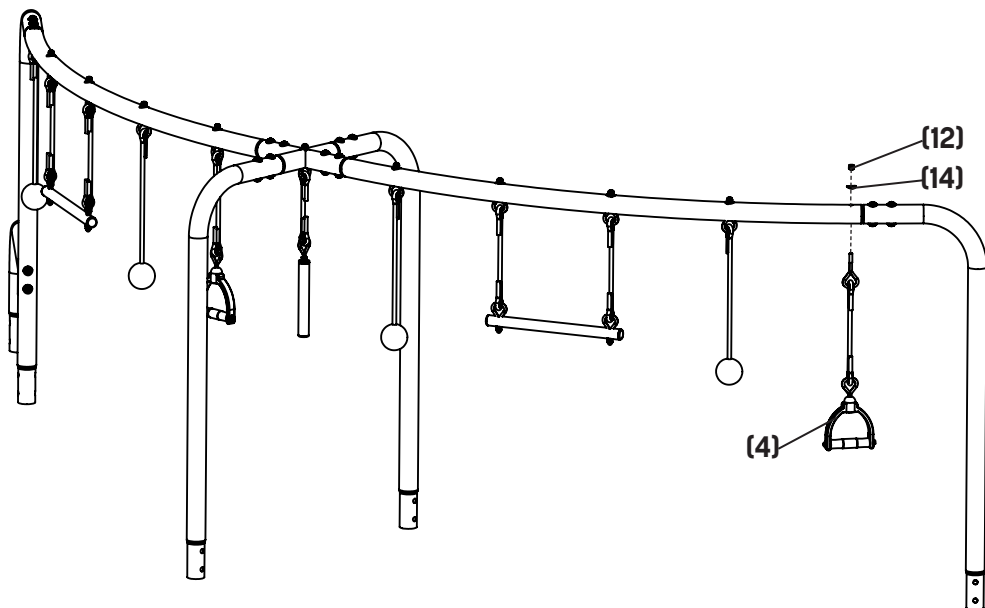

STEP 18



You will need another person for the next two steps. Attach the two Uprights (6) to the Curved Tube Frame 2 (16) in the middle of the Hanging Jungle Line with four M8X20mm Button Bolts (13) and four M8 Arc Washers (14).

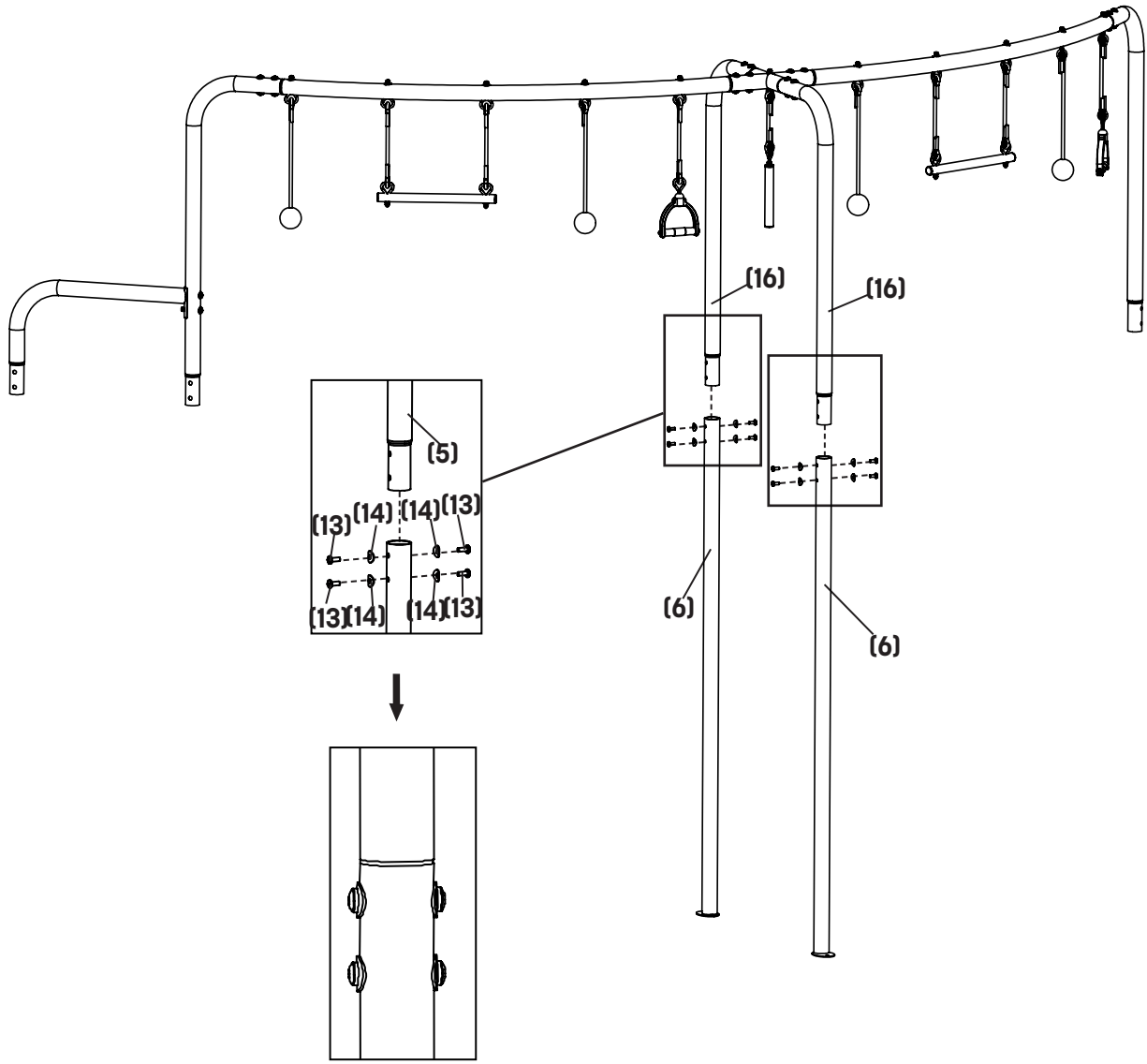

ASSEMBLY

STEP 19

- ① You will now need to remove the U Tube from your existing Hanging Bridge. After removing, keep the four M8x65mm Button Bolts, four M8 Arc Washers and two M8 Locknuts from the U tube.
- ② Now, insert the Curved Tube Frame (1) and the Curved Tube 2 (15) of the Hanging Jungle line to the top of the Hanging Bridge where you just removed the U tube. Use the hardware you reserved to secure.
- ③ Now, remove the Inner cap from the Monkey Bars, keeping the two M8X65mm Button Bolts, two M8 Arc Washers and the M8 locknut from the Monkey Bars. Insert the Curved Tube (5) of the Hanging Jungle Line into the Monkey Bar. Secure with the reserved M8X65mm Button Bolts, two M8 Arc Washers and the M8 locknut as shown.

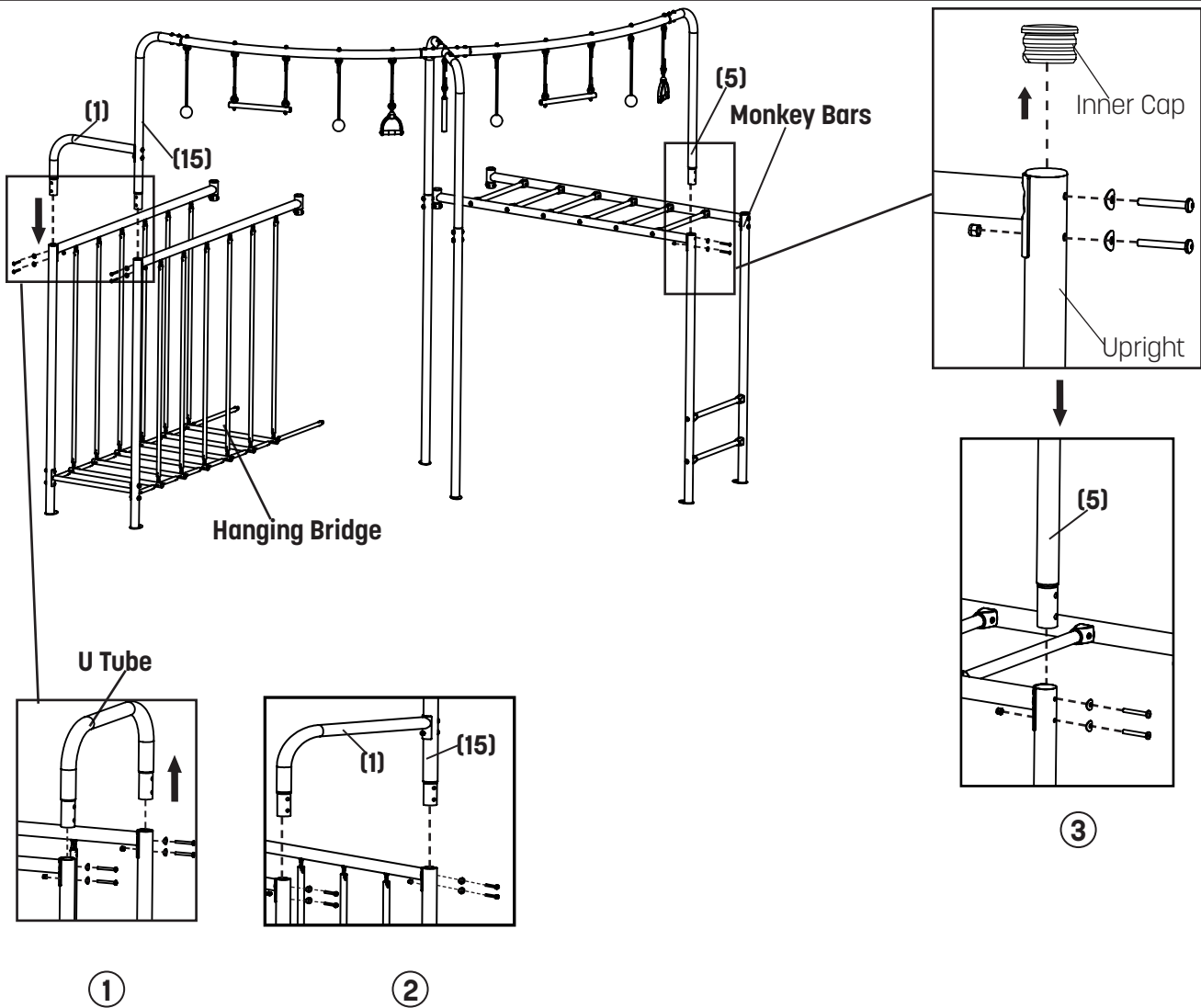

STEP 20

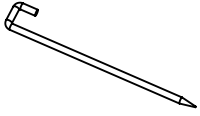

19 Anchor (x2)

Place an anchor **(19)** through the foot of each foot of the middle support tubes. Firmly push or hammer the anchors **(19)** into the ground. Take care that they are not a tripping hazard.

Do not skip this step, the anchors **(19)** are used to prevent tipping, overturning, or lifting of the support legs.

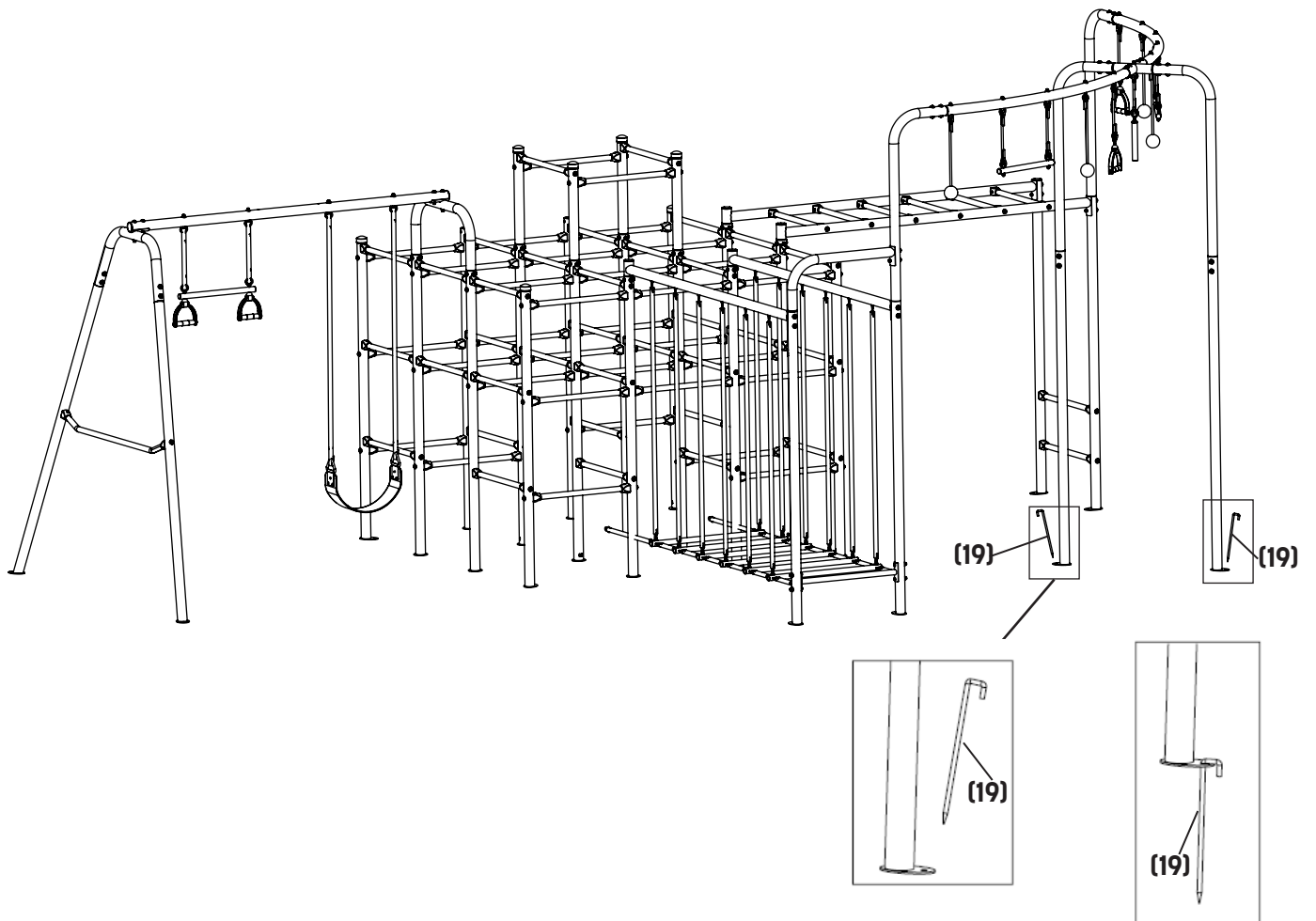

ASSEMBLY

STEP 21

Congratulations on completing your Activplay Hanging Jungle Line (*See, we knew you could do it!*) If you love the product, we want to hear from you! Please leave us a review on the retailer's site you purchased this product from, on our Facebook page, or on any other review site. We'd really appreciate it. If we could, we'd give you a gold star.

Are you frustrated or have some suggestions? Contact us directly. We promise we're not trying to ruin your life. We will do everything we can to make it right. See contact info on page 2-3.

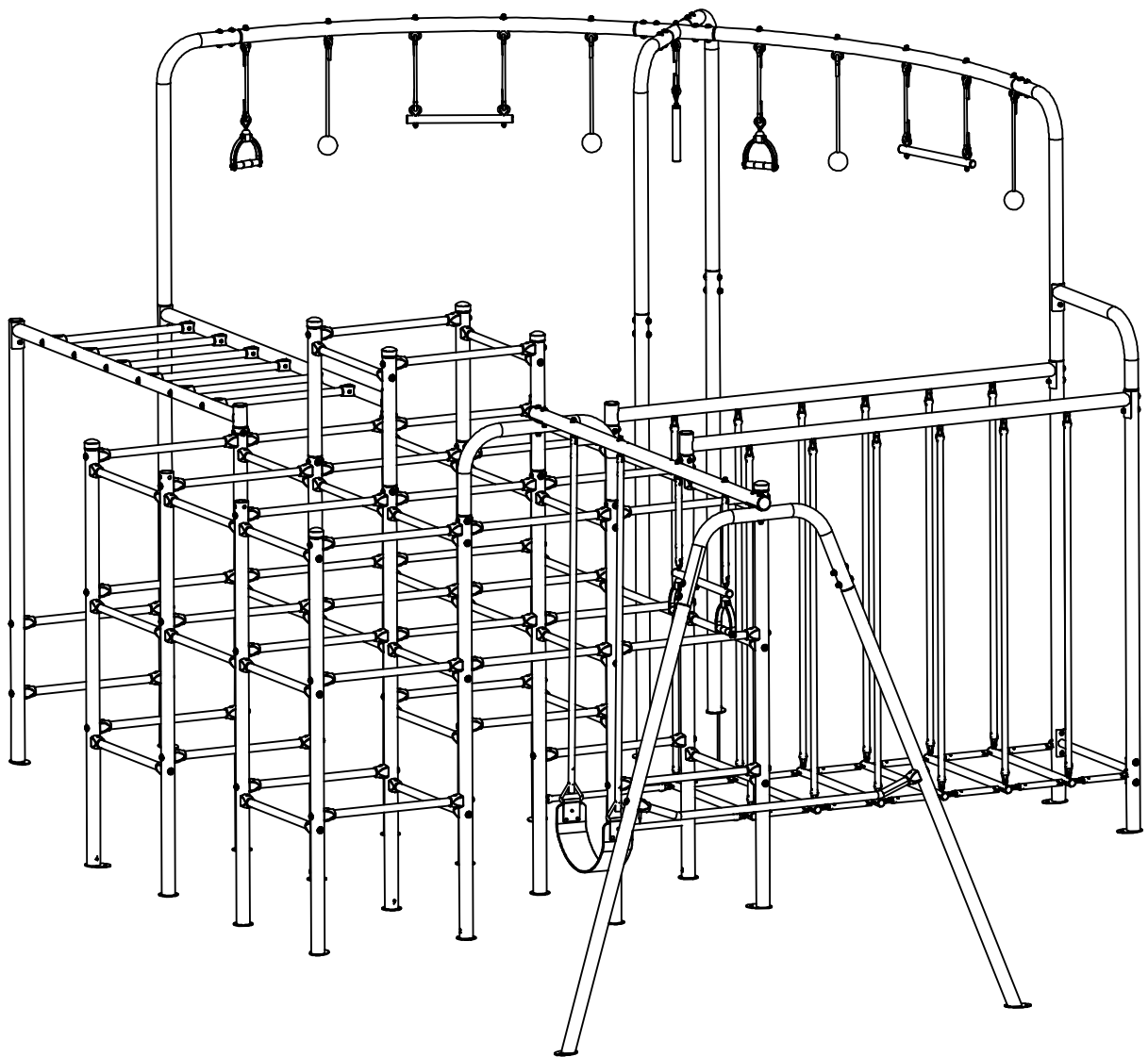

INSTALLATION

WARNING!

To reduce the risk of serious injury, read all important precautions and instructions in this manual and all warnings on the Hanging Jungle Line before assembly and use of this product.

1. It is the responsibility of the owner and supervisors of this Hanging Jungle Line to make sure all users obey the safety instructions printed in this material.
2. This product is intended for use by children ages 4-8.
3. Use the Hanging Jungle Line only as described in this manual.
4. Always use the Jungle Gym and its accessories under adult supervision.
5. Total weight capacity is 162 lbs.
6. Be sure that Jungle Gym and its accessories are on a level surface, not less than 6 ft (1.8m) from any structure or obstruction such as a fence, garage, house, overhanging branches, laundry lines, or electrical wires.
7. Do not install over concrete, asphalt, packed earth, grass, carpet, or any other hard surface. The maximum fall height for the product is 6.5 ft (2 m). A fall onto a hard surface can result in serious injury or death. The Jungle Gym and its accessories should never be placed on a hard surface such as concrete or asphalt.
8. It is recommended that the Jungle Gym Set be anchored to the ground. Be certain that all anchoring devices are placed below the level of the playing surface or below ground to prevent tripping. Anchors are sold separately.
9. It is recommended that the Jungle Gym and its accessories be placed on shock absorbing surface. Shredded bark mulch, wood chips, fine sand or fine gravel are considered to be acceptable shock absorbing surfaces when installed and maintained at a sufficient depth under and around Jungle Gym and its accessories.
10. Do not let children use equipment until properly assembled and anchored.
11. Always inspect the Jungle Gym and its accessories before use and replace any worn, defective, or missing parts and tighten any bolts that have become loose. (Users may be hurt if the Jungle Gym is used when it is in poor condition.)

MAINTENANCE & CARE INFORMATION

Congratulations and high five on successfully assembling your new Skywalker Sports Jungle Gym Base and/or accessories. Now, the best way to keep your new Skywalker Sports Jungle Gym Base and/or accessories in tip-top shape, is to follow this checklist periodically:

At the beginning of each play season:

- Tighten all hardware
- Lubricate all metallic moving parts
- Check metal parts for rust. If found, sand and repaint using a nonlead-based paint
- Reinstall any plastic parts, such as swing seats or any other items that were removed for the cold season

Twice a month during play season:

- Tighten all hardware
- Check all protective coverings on bolts, pipes, edges, and corners. Replace if they are loose, cracked, or missing
- Rake and check depth of loose fill protective surfacing materials to prevent compaction and to maintain appropriate depth. Replace as necessary
- Spot clean frame when dirt accumulates

Once a month during play season:

- Lubricate all metallic moving parts
- Check all moving parts including swing seats, ropes, cables, and chains for wear, rust, or other deterioration and replace as needed

At the end of each play season or when the temperature drops below 32°F:

- Remove plastic swing seats and other items as specified by the manufacturer and take indoors or do not use
- Rake and check depth of loose fill protective surfacing materials to prevent compaction and to maintain appropriate depth. Replace as necessary
- Owners shall be responsible for maintaining the legibility of the warning labels

Disposal Instructions: If discarding, disassemble and dispose of the Jungle Gym Base Station in such a way that no unreasonable hazards will exist at the time the Jungle Gym Base Station is discarded.

If any these conditions exist, this product should be disassembled or otherwise protected from being used until the condition is fixed.

JUNGLE GYM SAFETY INFORMATION

A Jungle Gym is a recreational product.

The information on this manual identify important safety precautions. The precautions are not all-inclusive, because a Jungle Gym can be used in ways that this manual cannot cover completely.

Using the Jungle Gym Safely

Adult Supervision of Children

Children using the Jungle Gym must be supervised by adults at all times

Adults may pay particular attention to:

- Entering and exiting the Jungle Gym safely
- Appropriate clothing, no loose-fitting clothing, scarfs, ponchos or clothing that is potentially hazardous
- Do not attach items to the Jungle Gym that are not specifically designed for use with the equipment, such as but not limited to, jump ropes, clothesline, pet leashes, cables, extension cords, garden hose and chains as they may cause a strangulation hazard
- Darkness increases the chances of a fall. Do not use the Jungle Gym unless there is plenty of lighting provided

Electrocutions Hazard Associated with the Metal Frame of the Jungle Gym

The Jungle Gym frame is made of metal. It is not grounded and will conduct electricity. For this reason, an electrocution hazard exists. No light, electric heaters, extension cords or household electrical appliances are to be permitted in or on the Jungle Gym at any time.

Placing the Jungle Gym in a Safe Place

To avoid injury, the Jungle Gym must be kept away from objects and possible hazards including electric power wiring, tree limbs, and fences. Do not place the Jungle Gym near any other recreational device or structures such as a swimming pool or hot tub. The Jungle Gym must be placed on a level surface before use. The area around the Jungle Gym must always have plenty of light.

For the Supervisor

Be familiar with the information in this manual and enforce all of the safety rules. Help new users and all user to the Jungle Gym. All Jungle Gym users must have someone watch them, regardless of the skill or age of the user. Keep the Jungle Gym free of any objects that could interfere with the proper use of the Jungle Gym such as but not limited to, jump ropes, clothesline, pet leashes, cables, extension cords, garden hose and chains as they may cause a strangulation hazard.

For the Jungle Gym User

Do not use the Jungle Gym when under the influence of drugs or alcohol. Do not attempt to jump onto or off of the Jungle Gym. Wear clothing that does not have drawstrings, hooks, loops or anything else that can get caught in the Jungle Gym.

INSTRUCTIONS FOR USE

To reduce the risk of serious injury, read and follow all of the warnings, precautions, and instructions in this manual before you use this equipment. Warnings and instructions for care, maintenance, and use of this Jungle Gym Base Station are included to promote safe enjoyable use of this equipment.

1. The Jungle Gym Hanging Jungle Line is designed for up to 2 persons and has a 162 lb. total weight limit.
2. On-site adult supervision for children of all ages at all times is required.
3. Instruct children not to walk close to, in front of, behind, or between moving items. Instruct children to keep a safe distance away to keep from being struck by items in play.
4. Instruct children not to twist swing chains or ropes or loop them over the top support bar since this may reduce the strength of the chain rope.
5. Instruct children to avoid swinging empty seats. These may strike other children or come back and strike you.
6. Teach children to sit in the center of the swings with their full weight on the seats. DO NOT allow children to stand on the seats and DO NOT allow children to lean to the side or collide with other playmates.
7. Instruct children not to use the equipment in any manner other than intended.
8. Instruct children not to get off equipment while it is in motion. Do not allow children to jump from moving play items.
9. Dress children in appropriate clothing while playing on and around the equipment. Do not allow the children to wear loose fitting clothing, hood and neck drawstrings, scarves, cord-connected items, capes, and ponchos. These items can cause death by strangulation.
10. Do not allow children to play on equipment when it is wet. Injury due to slips or falls may occur.
11. Instruct children not to attach items to the playground equipment that are not specifically designed for use with the equipment, such as, but not limited to, jump ropes, clothesline, pet leashes, cables and chain as they may cause a strangulation hazard.
12. Instruct children to always grasp the Jungle Gym frame rails while playing and climbing.
13. Check the openings between rollers and sliding surfaces of rollers slides for materials that could be potentially hazardous.
14. Make sure that suspended climbing ropes, chain, or cable are secured at both ends and cannot be looped back on itself.
15. Instruct children to remove their bike or other sports helmets before playing.
16. Dress children with well-fitting and full foot enclosing footwear. Do not wear clogs, flip flops, and sandals.
17. **WARNING:** Lawn swings are designed for use by children two years of age and older. The use by children under the age of two can result in entrapment between the seat and back rest because the child's body may pass through the opening, causing entrapment of the child's head. Such entrapment may result in strangulation. NEVER place children in a rearward facing position or with legs between the seat and backrest.
18. Instruct children to step on and off of the Jungle Gym Station, do not jump.
19. Check bolts before every use. Tighten any bolts that have become loose before allowing children to play.

Don't forget to check us out online! **We'd love to hear from you.**

Website: skywalkertrampolines.com

Facebook: facebook.com/skywalkertrampolines

YouTube: youtube.com/channel/UCUty7EqwIGouK5ovzGpHGGrw/feed

Pinterest: pinterest.com/swtrampolines

Twitter: twitter.com/swtrampolines?lang=en

Instagram: instagram.com/skywalker_trampolines/?hl=en

WARNING LABEL PLACEMENT

The labels shown on this page have been attached to the Jungle Gym Hanging Jungle Line in the indicated locations. If one of the labels or is missing or illegible, call our Customer Care Hotline toll-free at **1-866-603-JUMP (5867)**, Monday to Thursday, 8 a.m. to 5 p.m., and Friday, 8 a.m. to 3 p.m. Mountain Time, to order a free replacement label.



⚠ WARNING/ADVERTENCIA

Age Grading: 4-8 years
 Total Maximum Occupancy: 8 Children

Model	User Max	Weight Capacity
SJG200	3 children	243 lbs.
SJG201	2 children	162 lbs.
SJG202	1 child	81 lbs.
SJG203.1	1 child	81 lbs.
SJG204	See SJG201 & SJG203.1	
SJG205	1 child	81 lbs.
SJG206	See SJG205 & SJG208	
SJG207	See SJG202 & SJG209	
SJG208	1 child	81 lbs.
SJG209	2 children	162 lbs.

The total maximum weight not to exceed 648 lbs.

Model SJG209
 Hanging Jungle Line
 Made in China
 Skywalker Holdings, LLC
 PO Box 574, Brigham City, UT, 84302 U SA
www.Skywalkertrampolines.com
 Factory address: Qingda Industrial Park
 Chengyang Qingdao Shandong China

PLAYGROUND SURFACING MATERIALS

The following information is from Section 4 of the United States Consumer Product Safety Commission's (USCPSC) Outdoor Home Playground Safety Handbook for playground surfacing material.

X3. SECTION 4 OF THE CONSUMER PRODUCT SAFETY COMMISSION'S OUTDOOR HOME PLAYGROUND SAFETY HANDBOOK

X3.1 Select Protective Surfacing – One of the most important things you can do to reduce the likelihood of serious head injuries is to install shock-absorbing protective surfacing under and around your play equipment. The protective surfacing should be applied to a depth that is suitable for the equipment height in accordance with ASTM Specification F1292. There are different types of surfacing to choose from; which ever product you select, follow these guidelines:

X3.1.1 Loose Fill Materials:

X3.1.1.1 Maintain a minimum depth of 9 inches of loose-fill materials such as wood mulch/chips, engineered wood fiber (EWF), or shredded/recycled rubber mulch for equipment up to 8 feet high; and 9 inches of sand or pea gravel for equipment up to 5 feet high. NOTE: An initial fill level of 12 inches will compress to about a 9-inch depth of surfacing over time. The surfacing will also compact, displace, and settle, and should be periodically refilled to maintain at least a 9-inch depth.

X3.1.2 Use a minimum of 6 inches of protective surfacing for play equipment less than 4 feet in height. If maintained properly, this should be adequate. (At depths less than 6 inches, the protective material is too easily displaced or compacted.) NOTE: Do not install home playground equipment over concrete, asphalt, or any other hard surface. A fall onto a hard surface can result in serious injury to the equipment user. Grass and dirt are not considered protective surfacing because wear and environmental factors can reduce their shock absorbing effectiveness. Carpeting and thin mats are generally not adequate protective surfacing. Ground level equipment such as a sandbox, activity wall, playhouse or other equipment that has no elevated play surface does not need any protective surfacing.

X3.1.3 Use containment, such as digging out around the perimeter and/or lining the perimeter with landscape edging. Don't forget to account for water drainage.

X3.1.3.1 Check and maintain the depth of the loose-fill surfacing material. To maintain the right amount of loose-fill materials, mark the correct level on play equipment support posts. That way you can easily see when to replenish and/or redistribute the surfacing.

X3.1.3.2 Do not install loose fill surfacing over hard surfaces such as concrete or asphalt.

X3.1.4 Poured-In-Place Surfaces or Pre-Manufactured Rubber Tiles – You may be interested in using surfacing other than loose-fill materials like rubber tiles or poured-in-place surfaces.

X3.1.4.1 Installations of these surfaces generally require a professional and are not "do-it-yourself " projects.

X3.1.4.2 Review surface specifications before purchasing this type of surfacing. Ask the installer/ manufacturer for a report showing that the product has been tested to the following safety standard: ASTM F 1292 Standard Specification for Impact Attenuation of Surfacing Materials within the Use Zone of Playground Equipment. This report should show the specific height for which the surface is intended to protect against serious head injury. This height should be equal to or greater than the fall height – vertical distance between a designated play surface (elevated surface for standing, sitting, or climbing) and the protective surfacing below – of your play equipment.

X3.1.4.3 Check the protective surfacing frequently for wear.

X3.1.5 Placement – Proper placement and maintenance of protective surfacing is essential. Be sure to:

X3.1.5.1 Extend surfacing at least 6 feet from the equipment in all directions.

X3.1.5.2 For to-fro swings, extend protective surfacing in front of and behind the swing to a distance equal to twice the height of the top bar from which the swing is suspended.

X3.1.5.3 For tire swings, extend surfacing in a circle whose radius is equal to the height of the suspending chain or rope, plus 6 feet in all directions.

This information has been extracted from the CPSC publications "Playground Surfacing – Technical Information Guide" and "Handbook for Public Playground Safety." Copies of these reports can be obtained by sending a postcard to the: Office of Public Affairs, U.S. Consumer Product Safety Commission, Washington, D.C., 20207 or call the toll-free hotline: 1-800-638-2772.

LIMITED WARRANTY

Skywalker Holdings, LLC warrants its products to be free from defects in material and workmanship under normal use and service conditions. **The steel frame is warranted for three (3) years after the date of purchase. All other parts are warranted for one (1) year after the date of purchase.** Warranty coverage extends only to the original retail purchaser from the date of original purchase. This warranty is only valid concerning products used for residential use. Products used for commercial use, such as schools and daycares, will not be covered.

WHAT IS NOT COVERED?



Weather Damage: The warranty does not cover damage due to the effects or acts of nature, such as earthquakes, wind, hurricanes, tornadoes, lightning, rain, fire, snow, excessive heat and cold conditions and/or sun damage. During the winter months the soft materials will need to be removed and stored in a dry place out of the snow. If left unprotected in the winter months, some components may become damaged, voiding this warranty.



Fading and Rust: Our products are fully galvanized and/or powder-coated. We do not warrant against rust or corrosion. Some areas may have higher air salt content, higher humidity, heavier rain and heavier snow. We do not warrant against fading. We suggests customers use a UV protectant to extend the life of the product.



Loss or damage to Product: caused by shipping, abuse, misuse, improper/abnormal usage or unauthorized repairs are not covered by this warranty and may also void the warranty.



Unauthorized Replacement Parts: The warranty will become void if any defects or damages are associated with the use of unauthorized replacement parts. All replacement parts must be obtained from an authorized retailer.



Assembly Service: The warranty does not cover acts or omissions provided by a third-party assembly service. It is the customer's responsibility to check all boxes and confirm all components are included and in their proper condition before installation occurs.

INSPECTION AND REPLACEMENT PARTS:

1. Your product should be inspected upon unpacking and set up and thereafter on a regular basis. Worn, damaged or broken parts should be replaced immediately and before each use.
2. Call the Skywalker Holdings Customer Service Department at 1-866-603-5867 to file a warranty claim. Be prepared to provide the following information: name, shipping address, a copy of your original sales receipt, a brief description of the problem and cause, product model number and serial number. We may also ask for photos of the damaged/defective parts.
3. Customer service will review your claim and contact you with further instruction.

NOTE: All requested information must be provided in order to review your warranty claim.

To order replacement parts for your product please visit www.skywalkertrampolines.com

Skywalker Holdings, LLC, PO Box 574, Brigham City, UT 84302 USA.

Printed in China © 2020 Skywalker Holdings, LLC

NOTE: Skywalker Holdings, LLC is not responsible or liable for indirect, special or consequential damages arising out of or in connection with the use or performance of the product or other damages with respect to any economic loss, loss of property, loss of revenue or profits, loss of enjoyment or use, cost of removal, installation or other consequential damages. Some states do not allow the exclusion or limitation of incidental or consequential damages. Accordingly, the above limitation may not apply to you.

The warranty extended hereunder is in lieu of all other warranties and any implied warranty of merchantability or fitness for a particular purpose is limited in its scope and duration to the terms set forth herein. Some states or countries do not allow limitations on how long an implied warranty lasts. Accordingly, the above limitation may not apply to you. This warranty gives you specific legal rights. You may also have other rights which vary state to state or country to country.

This warranty is valid only in the country the product was purchased.