

SLC-400G LEG CURL

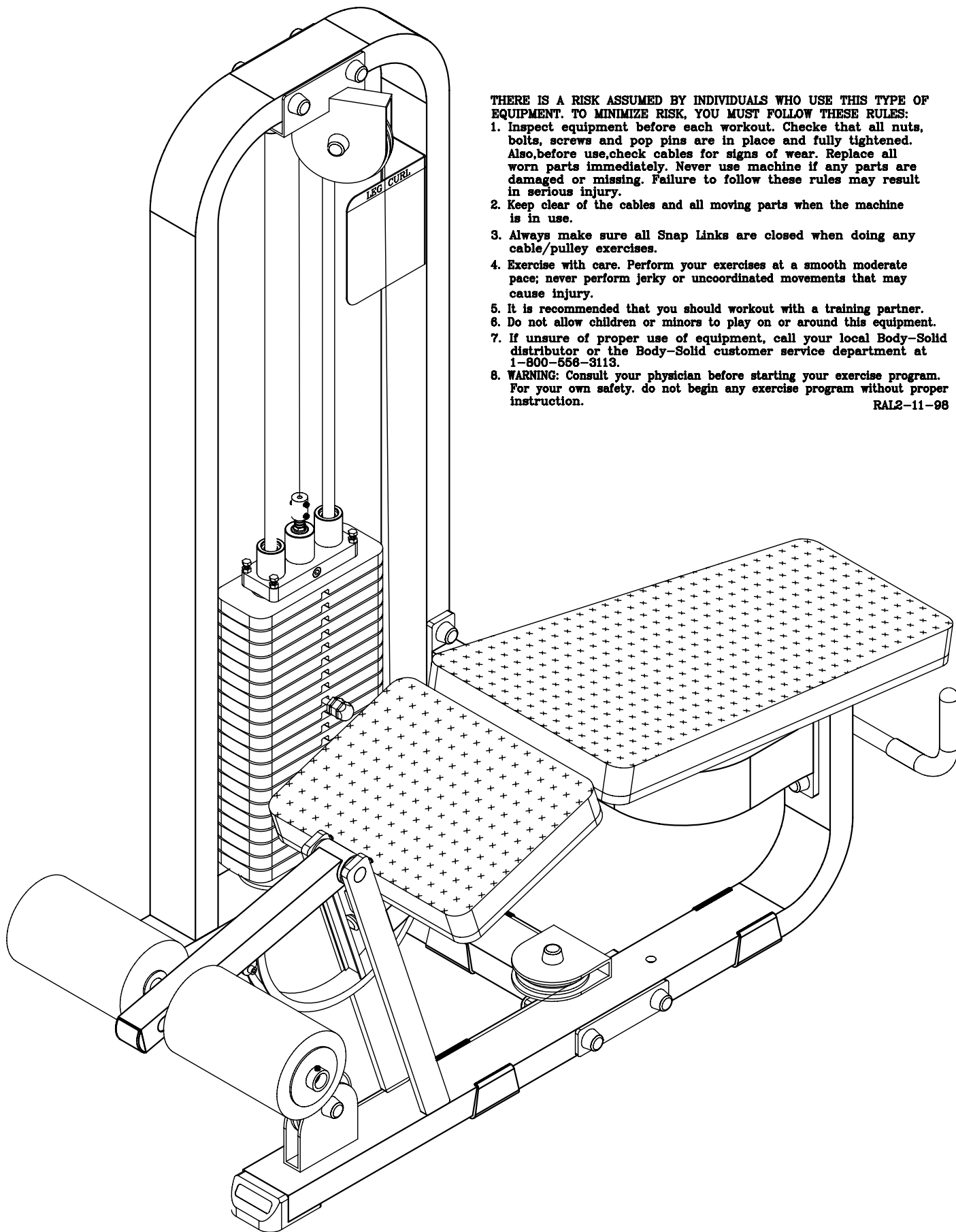









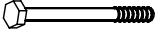
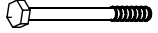
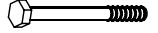
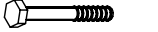





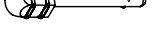

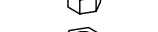

















THERE IS A RISK ASSUMED BY INDIVIDUALS WHO USE THIS TYPE OF EQUIPMENT. TO MINIMIZE RISK, YOU MUST FOLLOW THESE RULES:

1. **Inspect equipment before each workout. Check that all nuts, bolts, screws and pop pins are in place and fully tightened. Also, before use, check cables for signs of wear. Replace all worn parts immediately. Never use machine if any parts are damaged or missing. Failure to follow these rules may result in serious injury.**
2. **Keep clear of the cables and all moving parts when the machine is in use.**
3. **Always make sure all Snap Links are closed when doing any cable/pulley exercises.**
4. **Exercise with care. Perform your exercises at a smooth moderate pace; never perform jerky or uncoordinated movements that may cause injury.**
5. **It is recommended that you should workout with a training partner.**
6. **Do not allow children or minors to play on or around this equipment.**
7. **If unsure of proper use of equipment, call your local Body-Solid distributor or the Body-Solid customer service department at 1-800-556-3113.**
8. **WARNING: Consult your physician before starting your exercise program. For your own safety, do not begin any exercise program without proper instruction.**

RAL2-11-98

VERSION 200505

	Qty.
 A1. 1/2"X5 1/2" HEX HEAD BOLT -----	[6PCS]
 A2. 1/2"X5 1/4" HEX HEAD BOLT -----	[3PCS]
 A3. 1/2"X5" HEX HEAD BOLT -----	[2PCS]
 A4. 1/2"X3 3/4" HEX HEAD BOLT -----	[2PCS]
 A5. 1/2"X2 1/4" HEX HEAD BOLT -----	[4PCS]
 A6. 5/16"X1 1/4" HEX HEAD BOLT ----	[6PCS]
 A7. 7/16"X1 1/2" ROUND BOLT -----	[1PCS]
 A8. 5/16"X3/8" SET SCREW -----	[3PCS]
 A9. 5/8" ROUND BOLT -----	[1PCS]
 A10. 10LB BALL PIN -----	[1PCS]
 A11. 5/16"X1 1/2" ROUND BOLT -----	[1PCS]
 A12. ϕ 1/2"X22L SLEEVE -----	[1PCS]
 B1. 1/2" NYLON LOCK NUT -----	[17PCS]
 B2. 5/8" LOCK NUT -----	[1PCS]
 B3. 5/16" NYLON LOCK NUT -----	[1PCS]
 C1. 1/2" ROUND END CAP WASHER --	[33PCS]
 C2. ϕ 1" CHROME WASHER -----	[2PCS]
 C3. 5/16" (I.D)WASHER -----	[6PCS]
 C4. 5/16" SPRING WASHER -----	[6PCS]
 C5. 5/8" SPRING WASHER -----	[1PCS]

	Qty.
 D1. 1/2" BOLT CAP -----	[33PCS]
 D2. 2"X4" END CAP (9211-014)-----	[1PCS]
 D3. 2"X2"X1.8t END CAP (9211-087)----	[1PCS]
 D5. ϕ 3" NYLON WASHER (9214-008)-----	[4PCS]
 D6. ϕ 4" RUBBER DONUT (9310-017)-----	[2PCS]
 D7. ϕ 6" PULLEY (9213-009)-----	[1PCS]
 D8. ϕ 4 1/2" PULLEY (9213-010)-----	[3PCS]
 D9. 2"X4" FOOT CAP (9211-028)-----	[3PCS]
 D10. ϕ 3/4" SHAFT COLLAR (9211-046)---	[2PCS]
 D11. 2"X4" RUBBER DOUNT (9212-009)--	[3PCS]
 D12. ϕ 1"X10" RUBBER GRIP (9310-029)--	[2PCS]
 D14. ϕ 150X250 FOAM ROLLER (9161-016)	[2PCS]
 D15. CHROME TOP PLATE (8400-002)---	[1PCS]
 D16. WEIGHT SELECTOR BAR (8220-060)	[1PCS]
 D17. STEEL CABLE -----	[1PCS]
 D18. ϕ 3/4"X8L STEEL BUSHING (8110-014)-----	[2PCS]
 D19. ϕ 5/8" ROUND END CAP (9211-015)	[4PCS]
 D20. ϕ 1" SHAFT COLLAR (8130-024)----	[2PCS]

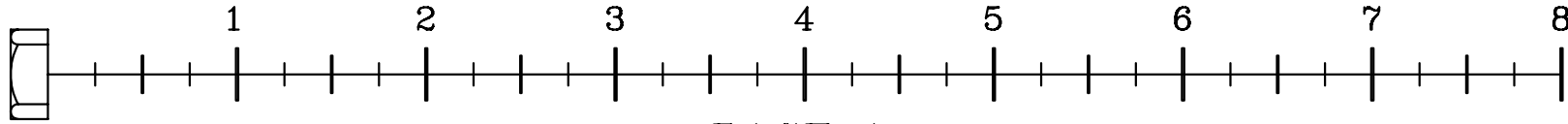
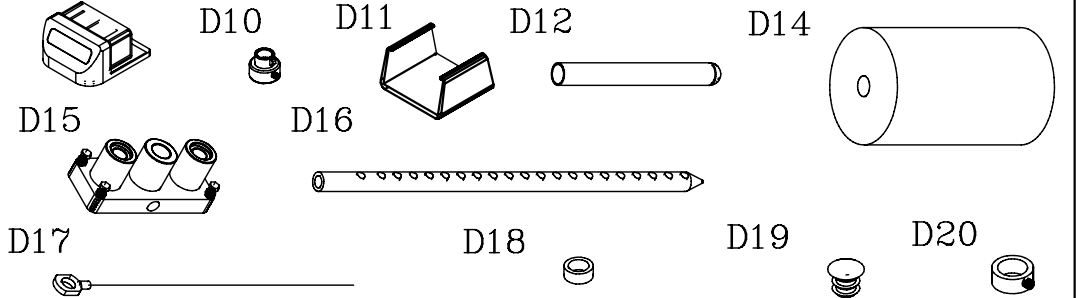

A [1PCS] WEIGHT STACK FRAME

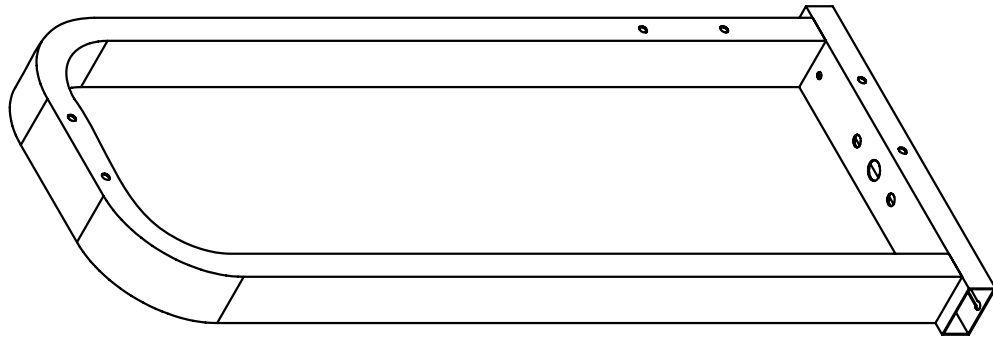

D [1PCS] MAIN BODY FRAME

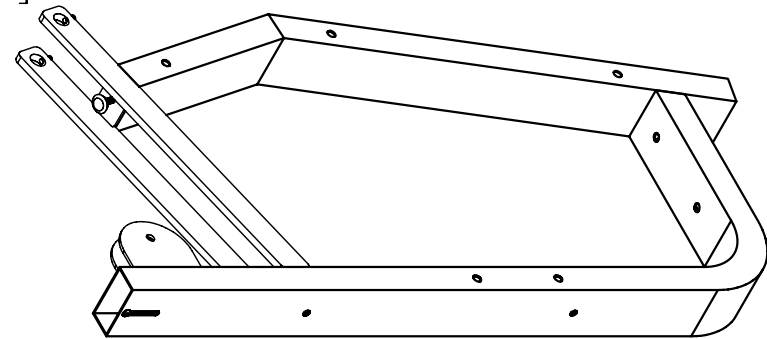

B [1PCS] BOTTOM PULLEY FRAME

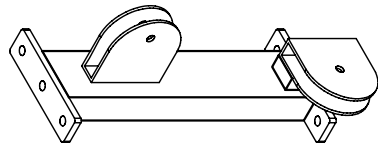

E [1PCS] HANDLE BAR

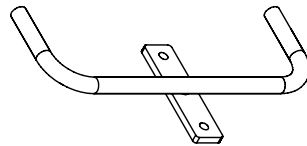

F [1PCS] LEG CURL FRAME

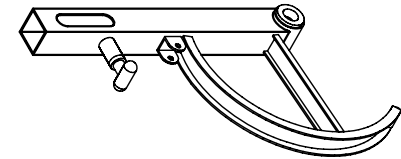

C [1PCS] MIDDLE SUPPORT FRAME

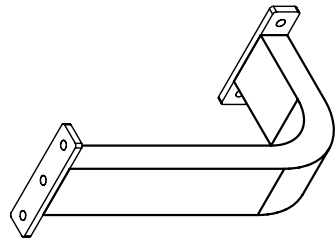

G [1PCS] TOP PULLEY FRAME

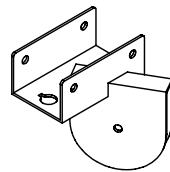

H [1PCS] ROLLER BAR FRAME



I [2PCS] CHROME GUIDE ROD

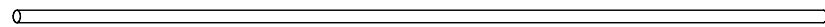

M [1PCS] BACK PAD

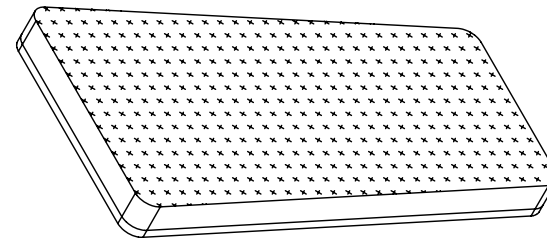

N [1PCS] SEAT PAD

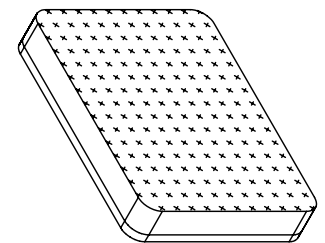

J-1 [1PCS]
FOOT ROLLER BAR
($\phi 1$ "X610mm)

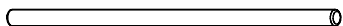

K [3PCS]
2"X8" PLATE

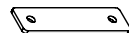

L [6PCS]
PAD BRACKET



SLC-400G

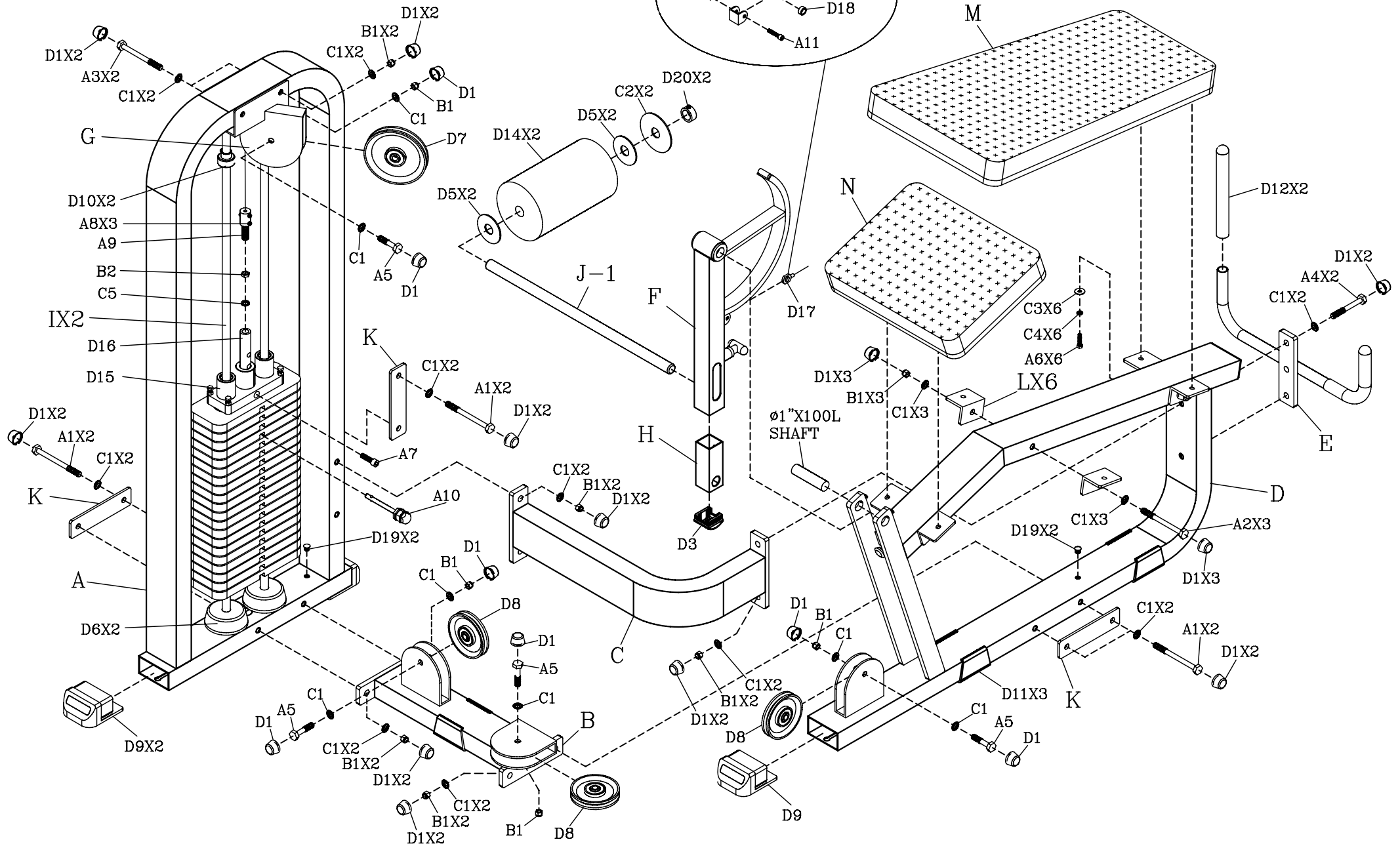

SLC-400G LEG CURL

ASSEMBLY STEPS

STEP-1

NOTE: DO NOT TIGHTEN NUTS AND BOLTS SECURLY UNTIL YOU HAVE COMPLETED ALL ASSEMBLY STEPS.

- Attach **A** Weight Stack Frame and **D** Main Body Frame to **B** Bottom Pulley Frame.
- Attach **C** Middle Support Frame to **A** Weight Stack Frame.
- Attach **C** Middle Support Frame and **E** Handle Bar to **D** Main Body Frame.
- Attach **F** Leg Curl Frame to **D** Main Body Frame.

STEP-2

- Attach **L** Pad Brackets to **D** Main Body Frame.
- Slide **H** Roller Bar Frame into **F** Leg Curl Frame.
- Slide **J** Foot Roller Bar into **H** Roller Bar Frame and attach **D14** Foam Rollers.
- Attach **M** Back Pad and **N** Seat Pad to **L** Pad Brackets.

**CAUTION: DO NOT OVERTIGHTEN PAD BOLTS.
OVERTIGHTENING WILL STRIP
T-NUTS IN THE WOOD.**

STEP-3

- Attach **I** Chrome Guide Rods and **D6** Rubber Donuts to **A** Weight Stack Frame.
- Slide Weight Stack and **D15** Chrome Top Plate onto **I** Chrome Guide Rods.
- Attach **G** Top Pulley Frame to **A** Weight Stack Frame and attach **D17** Steel Cable.

STEP-4

- Attach Pulleys and Cables as shown.
- Attach End Caps and Grips.
- TIGHTEN ALL NUTS AND BOLTS SECURELY.
- Attach Bolt Caps.

SAFETY RULES

1. Periodically check that all nuts,bolts and screws are fully tightened on your LEG CURL MACHINE.
2. Exercise with care. Perform your exercises at a smooth moderate pace; never perform jerky or uncoordinated movements that may cause injury.
3. It is recommended that you should workout with a training partner.
4. **Warning:** CONSULT YOUR PHYSICIAN BEFORE STARTING YOUR EXERCISE PROGRAM. IT IS ADVISABLE TO HAVE A PHYSICAL EXAMINATION BEFORE YOU ENTER ANY EXERCISE PROGRAM. FOR YOUR OWN SAFETY, DO NOT BEGIN ANY EXERCISE WITHOUT PROPER INSTRUCTION.

SLC-400G
LEG CURL

