

GSCL-360

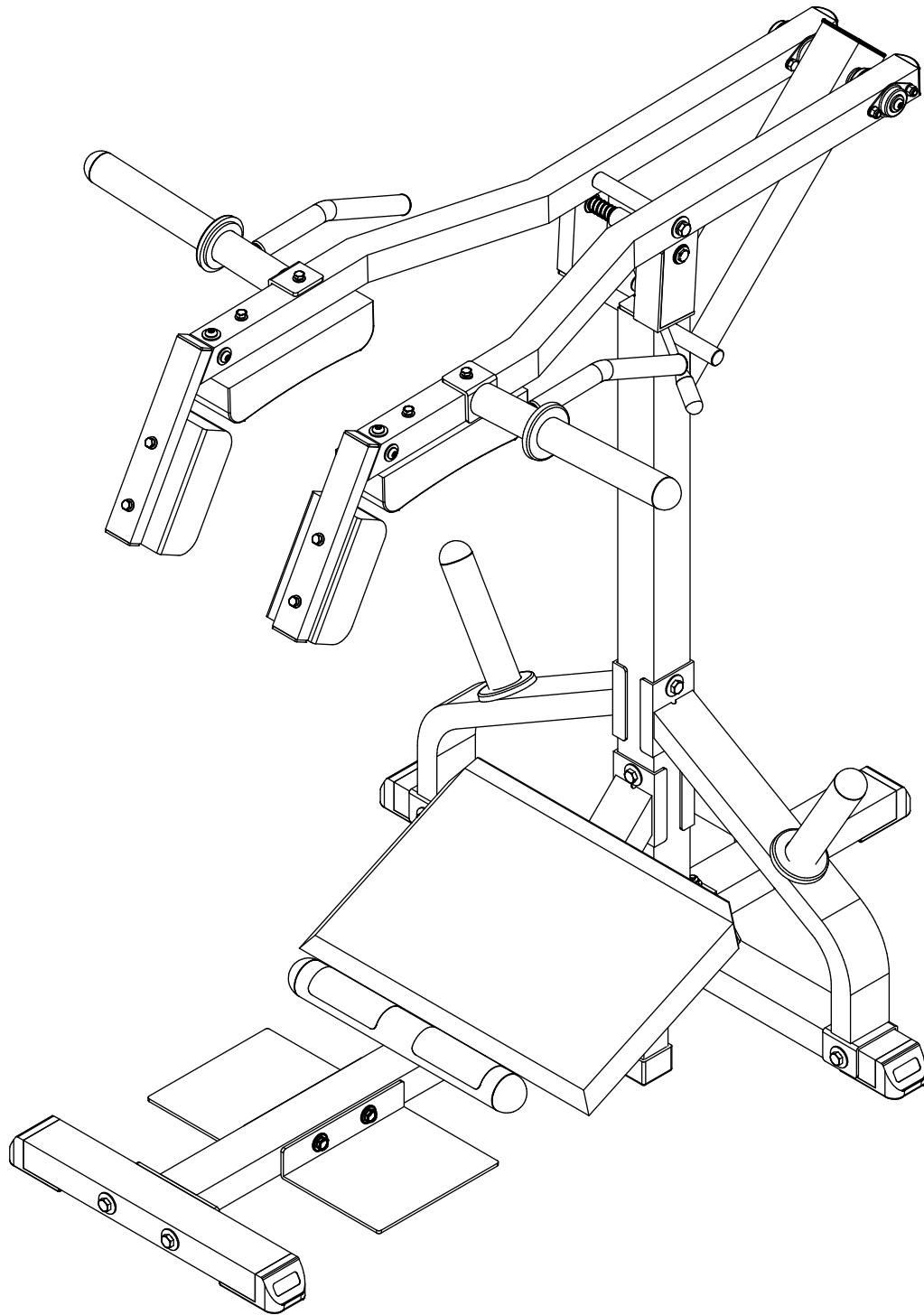

VERSION 0210

GSCCL-360

HARDWARE ILLUSTRATION SHEET

	Qty.
A1. M12x100 HEX HEAD BOLT	[12PCS]
A2. M10x100 HEX HEAD BOLT	[2PCS]
A3. M10x70 CARRIAGE BOLT	[2PCS]
A4. M8x70 HEX HEAD BOLT	[2PCS]
A5. M8x65 HEX HEAD BOLT	[2PCS]
A6. M8x40 HEX HEAD BOLT	[4PCS]
A7. 3/8"x2 3/4" HEX HEAD BOLT (pre-installed)	[4PCS]
A8. M12x25 HEX HEAD BOLT (pre-installed)	[2PCS]
A9. M12x70 HEX HEAD BOLT (pre-installed)	[2PCS]
A10. M10x16 ROUND BOLT (pre-installed)	[10PCS]
B1. M12 NYLON LOCK NUT	[12PCS]
B2. M10 NYLON LOCK NUT	[4PCS]
B3. 3/8" NYLON LOCK NUT (pre-installed)	[4PCS]
C1. M12 (I.D) WASHER (4 are pre-installed)	[28PCS]
C2. M10 (I.D) WASHER (10 are pre-installed)	[16PCS]
C3. M8 (I.D) WASHER	[8PCS]
C4. M8 SPRING WASHER	[8PCS]
C5. 3/8" (I.D) WASHER (pre-installed)	[8PCS]
C6. M20 (I.D) WASHER (pre-installed)	[2PCS]
C7. M12 SPRING WASHER (pre-installed)	[2PCS]

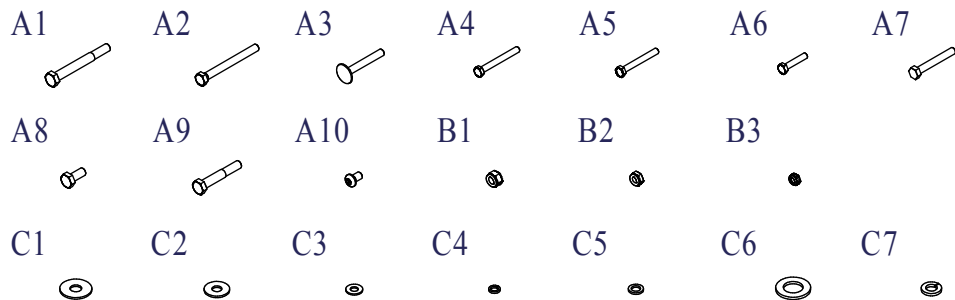

PARTS ILLUSTRATION SHEET

	Qty.
D1. 2"x2" PLASTIC COVER (9310-020)	[2PCS]
D2. 50x50 END CAP (9211-087)	[2PCS]
D4. 25x50 END CAP (9211-086)	[8PCS]
D5. Ø1" ROUND END CAP (9211-021)	[2PCS]
D6. Ø49.5 ROUND END CAP (9211-074)	[4PCS]
D7. 50x75 FOOT CAP (9211-025)	[5PCS]
D8. Ø60 ROUND END CAP (9211-075)	[2PCS]
D9. 50x75 RUBBER DOUNT (9212-011)	[1PCS]
D10. Ø90x10t RUBBER DOUNT (9310-016)	[4PCS]
D11. NON SKID TAPE (9630-003)	[2PCS]
D12. Ø20x1.5x70L STEEL SPRINGS (8840-012)	[1PCS]
D13. STORAGE PIN (8220-086)	[1PCS]
D14. OILITE BUSHING Ø20xØ26 (8520-003) (pre-installed)	[2PCS]
E1. BEARING 6004zz (pre-installed)	[4PCS]

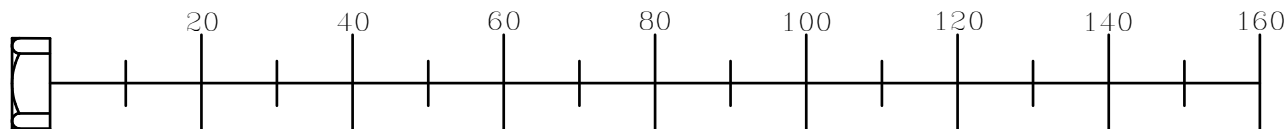
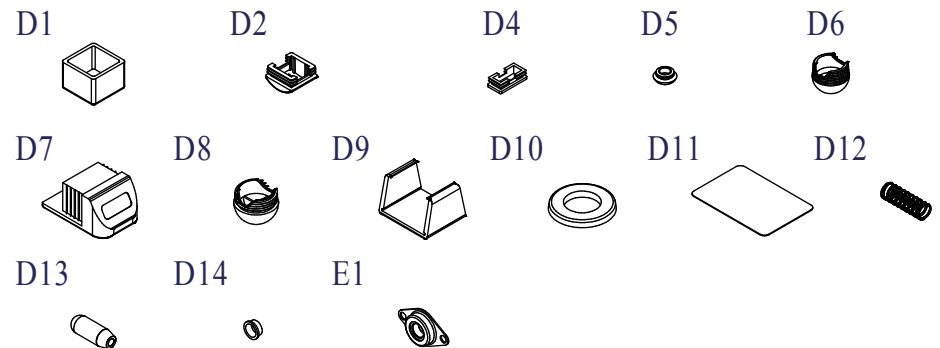

GSCL-360 PARTS ILLUSTRATION SHEET

A [1PCS]

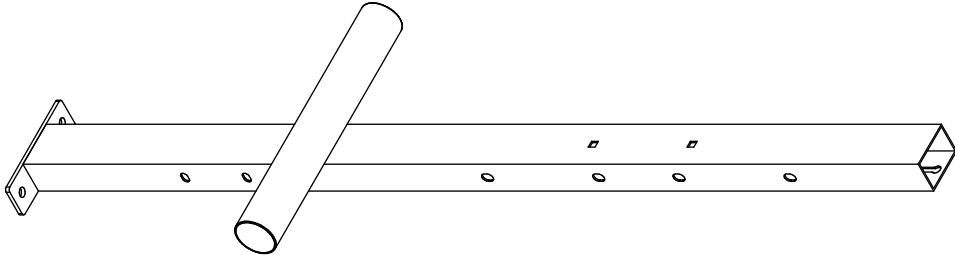

C [1PCS]

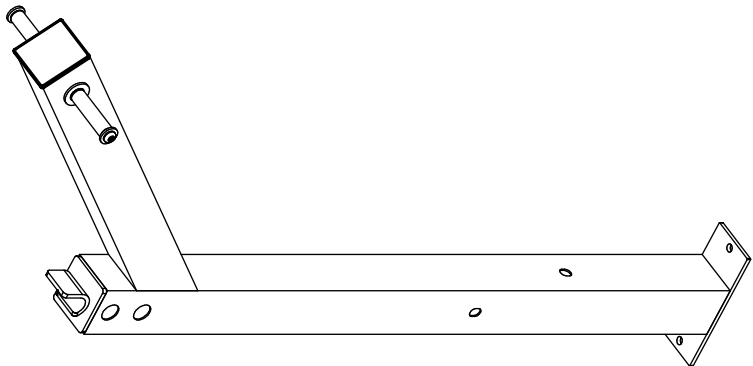

B [2PCS]

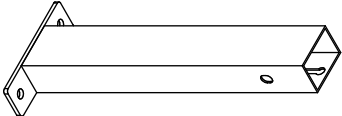

D [2PCS]

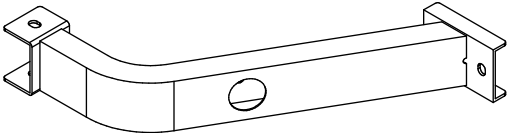

E [1PCS]

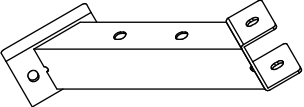

F [1PCS]

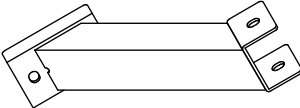

H [1PCS]

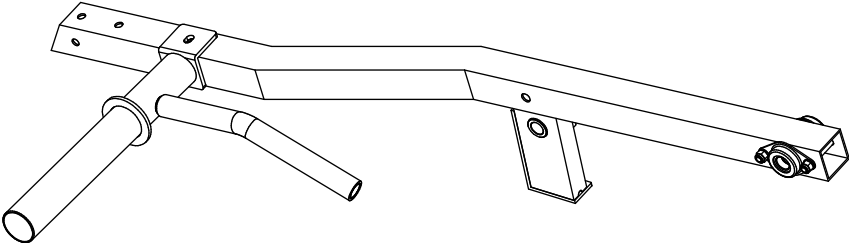

G [1PCS]

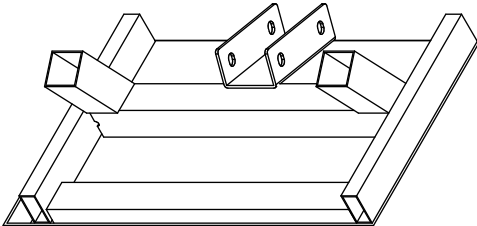

I [1PCS]

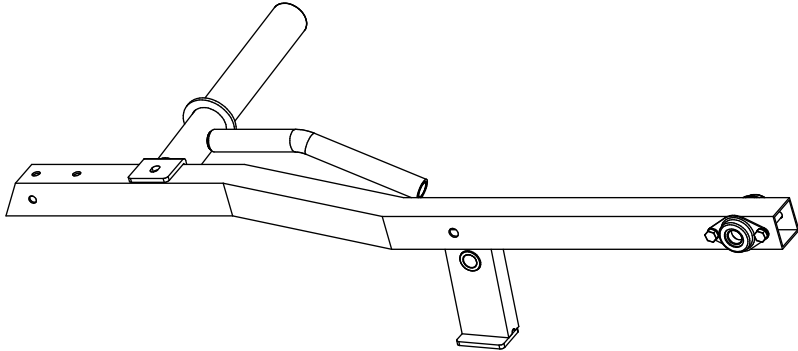

GSCL-360 PARTS ILLUSTRATION SHEET

J [2PCS]

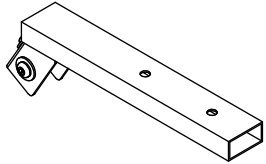

K [2PCS]

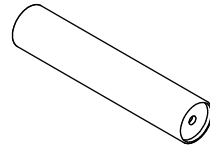

L [1PCS]

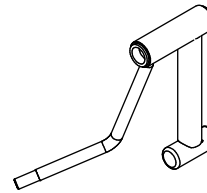

S [1PCS]
8210-058

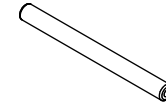

M [1PCS]

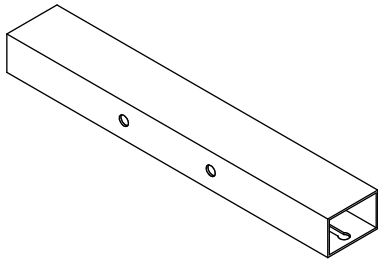

N [1PCS]
8220-094

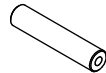

O [1PCS]
8220-087

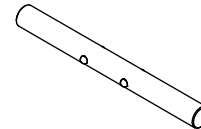

P [2PCS]

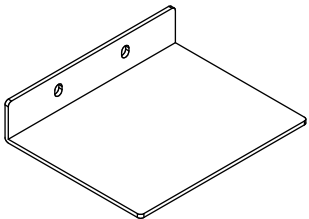

Q [2PCS]
9133-001

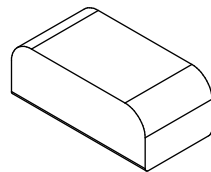

R [2PCS]
9133-002

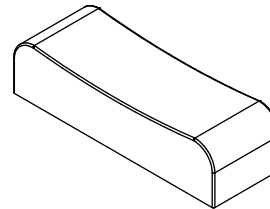

GSCL-360

Assembly Step 2

