

MODEL 73897



Security Outdoor Lantern

IMPORTANT SAFETY INSTRUCTIONS AND INSTALLATION GUIDE



FEIT ELECTRIC COMPANY
PICO RIVERA, CA, USA
(800) 543-3348 | FAX (562) 908-6360

www.feit.com

LIMITED WARRANTY

This product is warranted to be free from defects in workmanship and materials for up to 5 years from date of purchase. If it fails to do so, please contact Feit Electric at info@feit.com or call 1-866-326-BULB (2852) for instructions on replacement. This replacement is the sole remedy available and liability for incidental or consequential damage is expressly excluded. Do not return the product to the store. For comments please contact: Feit Electric Customer Service 4901 Gregg Road, Pico Rivera, CA 90660. www.feit.com.

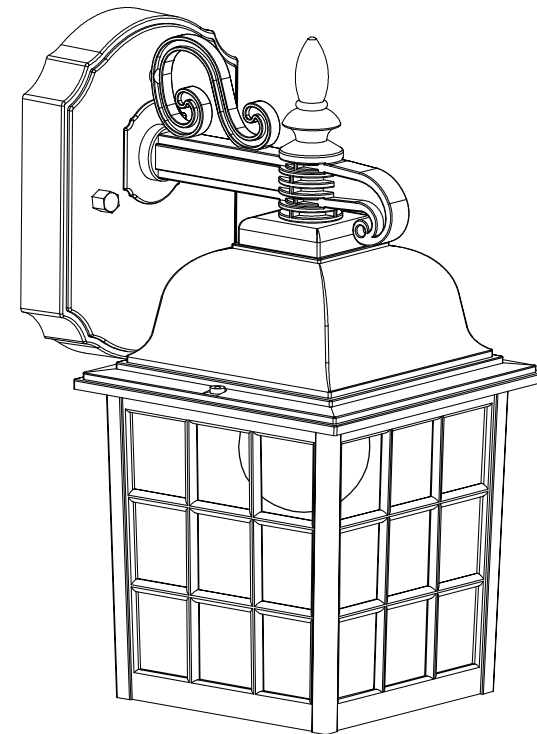

READ BEFORE INSTALLATION

SAVE THESE INSTRUCTIONS



WARNING:

This product may represent a possible shock or fire hazard if improperly installed or attached in any way. Product should be installed in accordance with the owners manual, current electrical codes and/or the current National Electric Code (NEC).

RISK OF ELECTRIC SHOCK: TURN OFF THE MAIN POWER AT THE CIRCUIT BREAKER BEFORE INSTALLING.

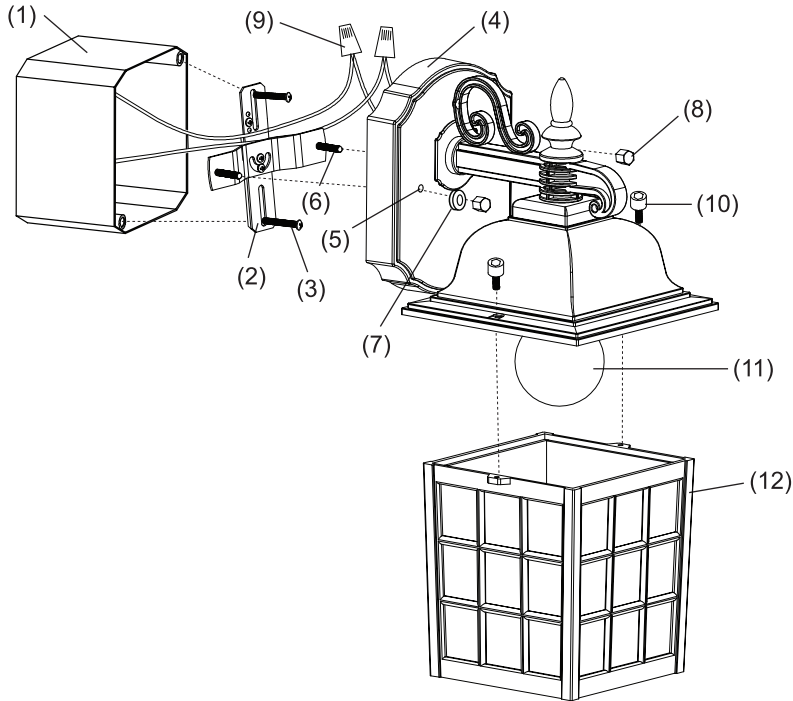

- | | | |
|-------------------------------------|--------------------------------|------------------|
| 1. J-Box (not included) | 6. Fixture Mounting Screws (2) | 10. Shade Screws |
| 2. Fixture Cross Bar (1 piece) | 7. Rubber Washers (2) | 11. LED diffuser |
| 3. J-Box Mounting Screws (2 pieces) | 8. Canopy Mounting Nuts (2) | 12. Shade |
| 4. Canopy | 9. Wire Nuts (3) | |
| 5. Canopy Holes | | |

PARTS INCLUDED TOOLS REQUIRED

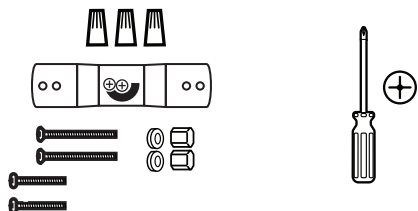

PRE-INSTALLATION

Remove the existing light fixture and disconnect house power supply wires.

INSTALLATION

1. Unscrew canopy mounting nuts and remove fixture crossbar.

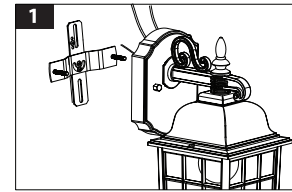

2. Pull power supply wires to the side and install fixture crossbar onto J-box with the screws provided.

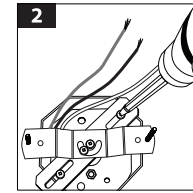

3. Using the wire nuts provided, connect bare grounding wire from the fixture to the house ground. Connect the white fixture wire to the neutral house wire. Connect the black fixture wire to the power supply wire.

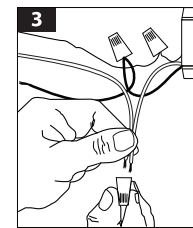

4. Adjust crossbar fixture screws and tighten center swiveling screws. Insert canopy holes through fixture mounting screws.

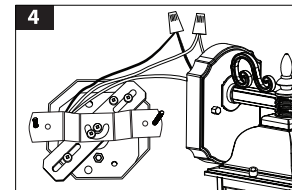

5. Position into place and secure fixture by installing washers and canopy mounting nuts. Place rubber washers onto fixture then tighten nuts.

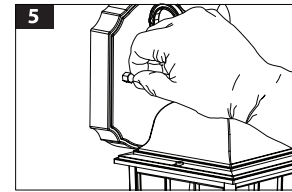

6. CAULKING AROUND THE FIXTURE

Caulk between the Light Fixture and the wall surface with silicone sealant (not included).

IMPORTANT WIRING INFORMATION

Always follow the recommended wire strip lengths and wiring combinations when connecting wires.

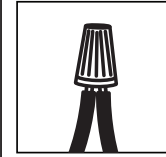

Hold stripped ends next to each other and align frayed strands (do not twist wires).

Push wires firmly into wire nut. Using your fingers, twist wire nut clockwise until tight. Check for tightness by pulling wires.

CAUTION

WARNING: Risk of fire. Use only on 120 volt 60Hz circuits. Suitable for wet locations. Do not use with dimmers. Before installing your lighting fixture, thoroughly review enclosed installation manual. If you do not have sufficient electrical wiring experience, please refer to a do-it-yourself wiring handbook or have your fixture installed by a qualified licensed electrician. All electrical connections must be in accordance with Local and National Electrical Code (NEC) Standards. Reliable operating temperature is 0°F –120°F. For more information visit www.feit.com or call our toll free number 1-866-326-BULB.