



TACTICAL



**Fighter®** was established in 1998 in Czech Republic, **Europe**. It is now a world recognized brand. Not only in Europe but in the **USA** and **Latin America** as well.

In addition to the development of traditional products, we bring to the market completely new products for combat training.

Thanks to having our production partly located in the Czech Republic, we are able to significantly accelerate development. Our partners, coaches, and professional athletes, help us to constantly improve our products.

All products from this catalog are designed by our team in the Czech Republic.

For actual offer and prices of Fighter® products visit: [www.fighters-inc.com](http://www.fighters-inc.com) for the USA [www.fighters-europe.com](http://www.fighters-europe.com) for Europe



TACTICAL TARGET



TRAINING BAG



TACTICAL SLEEVE



TRAINING SHIELDS



TRAINING BATON



SPECIAL USE VELCRO



PROTECTIVE TRAINING SUITE



OTHER GEAR

For the Czech Republic: [www.hayashi.cz](http://www.hayashi.cz) | [info@hayashi.cz](mailto:info@hayashi.cz) | +420 608 953 591



VIDEO

# TACTICAL TARGET SCUTUM



The Fighter Scutum 2in1 rounded shield is specially made for training punches with a baton or similar weapon such as a tonfa, escrima, etc. The front white layer is made of a special rubber fabric that is highly resistant to punches and abrasions. The shield has been tested for a long time with a steel baton. The shield is equipped with four handles for greater training variability.

The back of the shield with handles is removable. After removal, the back is covered with Velcro, thanks to which the shield can be attached to the Power wall.

The filling is made of a special foam mixture, so the shield absorbs even the strongest blows perfectly.



1108SD





How to use Scutum on a wall? Go to page ► 14!



How to use Scutum on a tree? Go to page ► 14!



- width 46 cm (18"), height 66 cm (25"), thickness 25 cm (9½")
- extremely durable materials
- all materials used are made in the EU
- product is made in The Czech Republic
- easy to wash

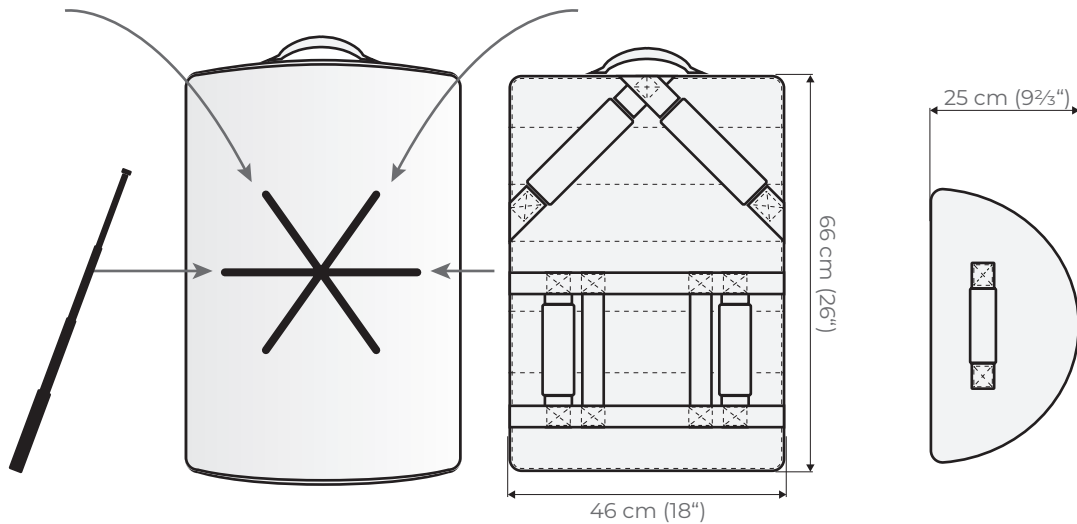



## FREE-STANDING BAG **UNIVERSAL 3in1**

The universal free-standing punching bag Fighter 3in1 offers a completely new training experience.

The main function is to use it as a free-standing bag. Because most of the weight is at the bottom, the bag gives you great feedback after punching or kicking.

Thanks to the weight of the base (approx. 38 kg, 83 pounds) and the weight located on the

bottom of the bag (approx. 15 kg, 35 pounds) the bag is very stable. There is additional velcro on the bottom of the bag and inside of the base. This ensures sufficient attachment of the bag to the base. At the same time, with 4 integrated handles, you can easily carry the base and use the bag in different places.

The canvas of the bag and the base is made of a very durable

Hitex Polyplan from Austria. This material is also very easy to maintain. The bag's filling is made of several layers. Closest to the coat is the Trocellen PE from Italy. Below is PUR HD from the Czech Republic and the core is made of recycled rubber crumb. The base is supplemented by sand. Thanks to these materials, the bag can also be used outdoors. However, the maintenance instructions

must be followed! The whole bag was developed in the Czech Republic in cooperation with athletes from various martial arts disciplines.





VIDEO

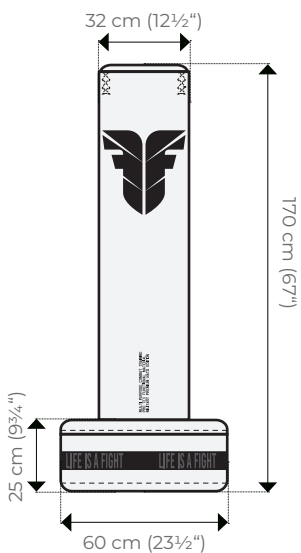

- 3in1: free-standing bag, dummy and hanging heavy bag
- Suitable for the gym and home
- Easy handling
- Easy to wash
- Durable material
- Height ~ 5 ft 7 in (170 cm)
- Weight: base ~ 83 pounds (38 kg), bag ~ 50 pounds (23 kg)
- Made in Europe
- Suitable for outdoor use (see maintenance instructions)
- Protected by a Czech utility model no. 34704 and an international patent application PCT/IB2021/056217



VIDEO



# PROTECTIVE SLEEVE



Protective Sleeve for the punching bag is specially made for training with steel weapons such as a baton. The white layer is made of a special rubber fabric, which is highly resistant.

The sleeve was tested by hitting it with steel baton and also with the end of firearm weapons.

The cover is attached with Velcro.

- *baton protection*
- *Made in EU*





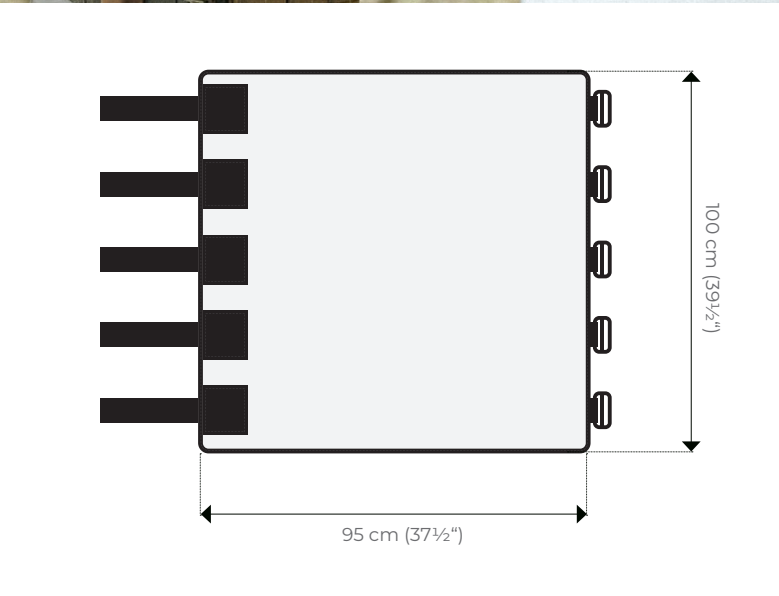
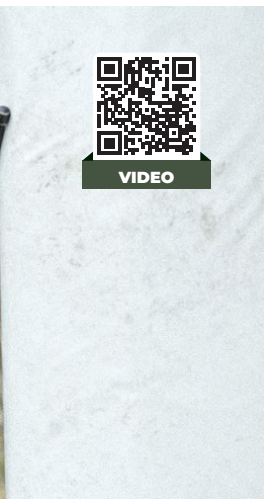



VIDEO

## CURVED SHIELD **MULTIGRIP**

Multi-grip shield is rugged and durable. Great for a punch, kick or strike. Curved shield is ideal for all your MMA, Muay Thai and combat training demands. Super shock absorbing foam welcomes every offensive blow and strike. Slightly contoured design is ideal for any athlete and trainer.

Multi-position nylon webbing and padded handles on the back, top, sides and bottom make for comfortable holding positions and allow custom training options.

- **Size:**  
35 cm x 75 cm x 15 cm  
(13¾" x 29½" x 6")
- **Durable PVC**
- **Super shock absorbing foam**
- **4 straps on sides and 4 on back**



FKSH-14





FKSH-13



FKSH-15

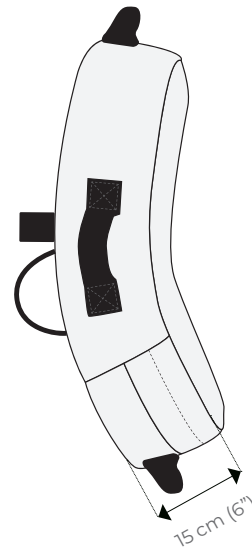
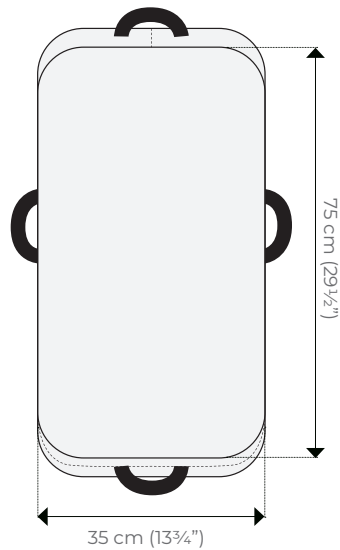



VIDEO



## LARGE ROUND SHIELD



Provides unlimited options for various trainings thanks to its light weight, two handles, and durable PVC/polypropylene material. For specific training, specific equipment is needed. This traditional punch or kick shield provides almost 18 inches or hitting area for direct kicks and punches.

- Made of PVC
- Two grip bars for easy handling
- 45 cm x 15 cm (17¾" x 6")



FKSH-18



FKSH-16



FKSH-17

# KICK PADS **THAI MAXI**

Made of high-endurance PVC. Large square design with one padded handle and two adjustable velcro straps for comfortable handling. Lightweight yet almost 6 inches thick. Ideal for long Muay Thai training classes where coaches have to use great strength to resist hundreds of hard kicks and punches. For these reasons, these Kick Pads are much better than the traditional heavy-weight pads.



VIDEO

F01602-TSC



F01602-TSC

F01602-TSD

# ROUND **TARGET**



Provides a stiff shock-resistant area to absorb strikes. The outer Red and Black PVC surface covers an inner solid foam core. This mitt comes with a solid hand grip and hook and loop adjustable Velcro wrist strap to give the wearer a secure hand hold position.

- 2 straps
- reinforced pu foam inside
- 25 cm (10")



FFM-1523  
LITE ultralight (0.32 Kg, 0.7 pound)

- Padded grip handle and two velcro straps
- Six inches of reinforced pu foam inside
- Rigid and durable outside pvc is easy to clean
- 20 cm x 40 cm x 15 cm (8" x 15¾" x 6")





VIDEO



# TRAINING STICK

The training stick is for practising full contact training with baton and similar weapons. The tough core is covered with protective foam and water resistant heavy duty textile. Training stick is also equipped with a handle.

- *light weight*
- *suitable for full-contact*
- *water resistant*
- *length 66 cm (26")*



TRABAT-1



# TRAINING BATON

Overall length of this training stick is 53 cm (21"). We choose this size as it is the most common length of steel expandable batons. This makes it ideal to practice techniques with a real baton.

- *real baton size*
- *suitable for full-contact*
- *water resistant*
- *length 53 cm (21")*



TRABAT-2

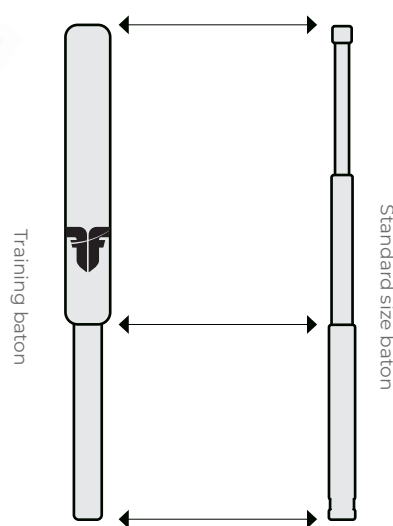



*Extender Velcro XL is great for use with a tree, pole or boxing bag.*



VIDEO



*OSB board covered with velcro is made to be mounted on wall. You can attach a Scutum or other mitts.*

## SPECIAL USE

To make your training easy and more diverse, we have a smart solution to train without a sparring partner. It is based on super strong velcro, that affixes your mitts and targets.

You can choose between two solutions. A board you can attach to a wall or a sleeve which can be used on a tree, boxing bag or a pole.

- *smart solution*
- *super strong velcro*
- *no opponent needed*

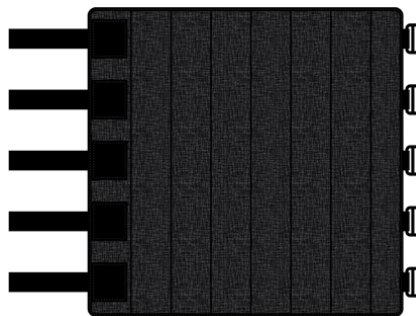

**FFS-04**

*Extender Velcro XL  
Size 100 cm x 90 cm (39½" x 35½")*

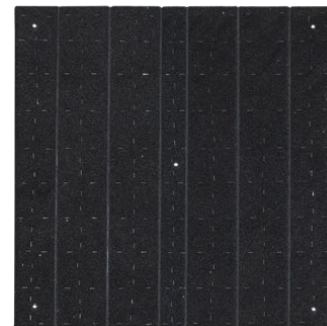

**FPWS-02**

*OSB board covered with velcro.  
Size 62 cm x 62 cm (24½" x 24½")*





PROTECTIVE TRAINING SUITE  
COMMING SOON...





VIDEO

## BOXING GLOVES **SPEED**



These FIGHTER brand gloves fit great and can be used for different types of training. They are a perfect option, especially made for beginners, students training or cardio fitness. Inside the glove padding is firm, a machine mold foam provides sufficient protection and comfort.

- *Wide cuff with industrial velcro wrist straps*
- *Perfect for cardio fitness and boxing students training*
- *Comfortable wear with secure wrist strap*
- *Firm and evenly padded - one-piece injection molded glove*



**TH1612PU KHB**

khaki/black

8 oz, 10 oz, 12 oz, 14 oz, 16 oz



**TH1612PU RDB**

red/black

8 oz, 10 oz, 12 oz, 14 oz, 16 oz



VIDEO

## MMA GLOVES **COMPETITION**



These Mixed Martial Arts Gloves are made of high-quality synthetic leather with three sections separated by flexibility joints for maximum freedom of movement. The first section of thick padding covers from the knuckles to the first finger joint with no gaps. Second section is perforated for cooling and the padding protects the back of the hand. Third section is the unique wrist cuff that secures the wrist with the double strapping system.

- *Three section gloves for maximum freedom of movement*
- *Equipped with padded thumb joint protection.*
- *Double closure system provides fast and secure fit.*



**FMG-002CBK**  
black/camo  
M, L, XL



**FMG-002CKH**  
white/camo  
M, L, XL



VIDEO

# HEAD GUARD **SHOCK**

„Versatile head guard for all martial arts“. Steel mask makes for ultimate face safety for both armed and unarmed combat.

- *Steel mask*
- *Genuine leather*



**JE999-BLK**  
*black*  
M, L



**JE999-KHC**  
*khaki*  
M, L



## SHIN GUARDS **ERGO**

This Fighter Thai Ergo model is made of artificial leather. They are specially molded to provide safety and comfort during training. Padding is reinforced in shin area for even higher security. Its light construction and ergonomic shape gives you freedom of movement. Lining is anti-slip and breathable. Velcro with buckle fastening system for stable positioning.

- *Velcro with buckle*
- *Unique design*
- *Anti-slip and breathable lining*
- *Light construction*
- *Reinforced padding*
- *Ergonomic shape*



**FSG-004KBC**  
khaki/camo  
XS, S, M, L, XL



**FSG-004BB**  
black  
XS, S, M, L, XL



# BELLY PAD **TARGET**



This body target made by Fighter is great part of trainers gear. Its multi-layered 6 cm thick construction gives you support during intensive and heavy training. Padded shoulder straps are designed for maximum comfort and can be customized to your body.

- *Superior protection*
- *Free hands during training*



**FBP-03**  
black/khaki



# GROIN GUARD **FIGHTER**



A new addition from Fighter for groin protection. The classic steel resin molded cup has been modified to be worn with a modern jock strap instead of the traditional 3 string models. It is extremely comfortable and still provides the necessary protection.

- *High endurance*
- *Easy to use*



**JE1577**  
black  
S, M, L, XL





**fighter**  
MARTIAL ARTS EQUIPMENT

DESIGNED | **IN THE**  
TESTED | **CZECH**  
PRODUCED | **REPUBLIC**

LIFE IS A FIGHT LIFE IS A FIGHT

[www.hayashi.cz](http://www.hayashi.cz) | [info@hayashi.cz](mailto:info@hayashi.cz) | + 420 608 953 591