

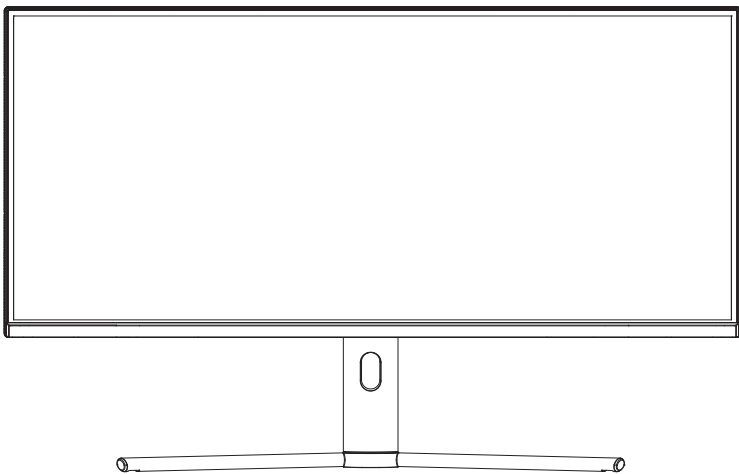

TITAN ARMY

# USER MANUAL FOR MONITOR



C34CHR

## Precautions

Please read this manual carefully before using the product and keep it in a safe place.

---

- Keep the monitor away from water sources or damp places, such as bath rooms, kitchens, basements and swimming pools.
- Make sure the monitor is placed on a flat surface. If the monitor falls down, it may cause human injury or device damage.
- Store and use the monitor in a cool, dry and well ventilated place, and keep it away from emission and heat sources.
- Do not cover or block the vent hole in the rear casing, and do not use the product on a bed, sofa, blanket or similar objects.
- The range of the supply voltage of the monitor is printed on the label on the rear casing. If it is impossible to determine the supply voltage, please consult the distributor or local power company.
- If the monitor will not be used for a long period, please cut off the power supply to avoid electric shock in rainy days and damage due to abnormal supply voltage.
- Please use a reliable grounded socket. Do not overload the socket, or it may cause fire or electric shock.
- Do not put foreign matters into the monitor, or it may cause short circuits resulting fire or electric shock.
- Do not disassemble or repair this product by self to avoid electric shock. If faults occur, please contact the after-sales service directly.
- Do not pull or twist the power cable forcedly.
- Please use a reliable grounded socket. Do not overload the socket, or it may cause fire or electric shock.

# Package Content

## Packing list

- Please check that the package of the monitor contains all parts. If any part is lost, please contact the distributor.
- The color and shape of parts may vary with models. Figures in this User Manual are for reference only.
- Cables supplied may vary with purchased products. Figures in this User Manual are for reference only.



Monitor



Stand

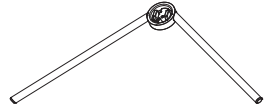

Base

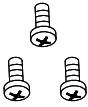

Screws x3

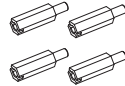

Mount studs x4

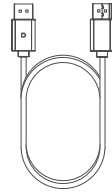

DP signal cable

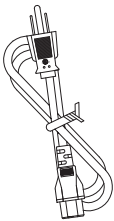

Power cable



User manual

- Redundant screws can be used as spare screws.

# Installation

## Installation of base

1. Open the package and take out the product with the foam still attached. Gently place it on a desktop or table.
2. See picture fasten the stand stem and base with a screw.

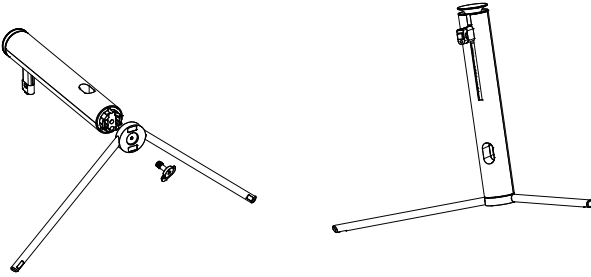

3. Press the button to remove the stand plate, Fix the stand plate into the stand stem with the supplied screws.

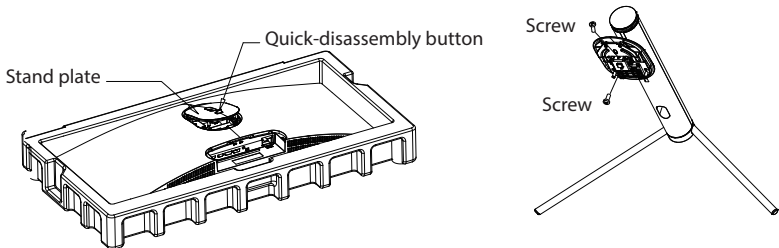

4. Fix the whole assembled stand into the monitor, and check carefully to make sure it is fastened.

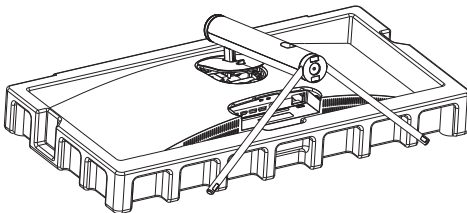

# Installation

- Stand the monitor up on the assembled base. (Note: Do not squeeze the screen directly with your hands during the process of standing up the monitor to prevent it from breaking)

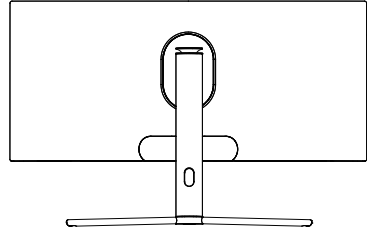
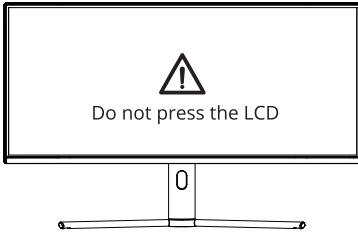

## Installation of mount

- Open the package to take out foams and put them on a flat tabletop.

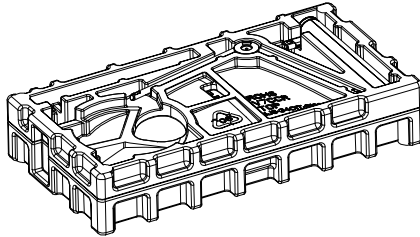

- Press the button to remove the stand plate, then tighten the included four mount studs onto the mounting holes on back of monitor. Install the monitor on the wall, mount, or fixture as desire.

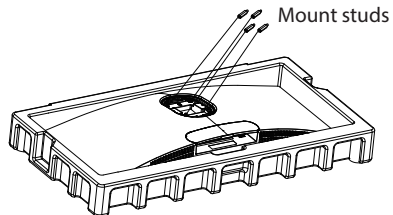
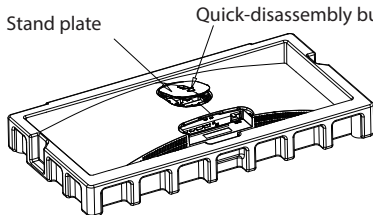

## Installation

---

3. During hanging of the product, do not pinch the screen with hand to avoid damage to the screen.  
Tips: The mounting hole distance of the mount for the product is 75x75mm.

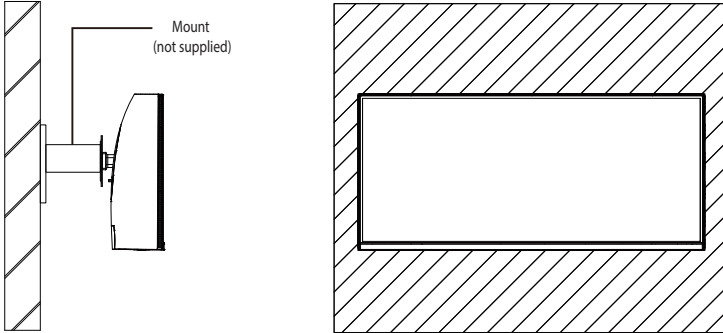

Notes: To prevent the monitor on the mount from failing, please install it firmly and protect it fully.  
Do not place or hang any object on the mount, and the using height of the mount should be less than 2 meters.

# Adjustment of monitor

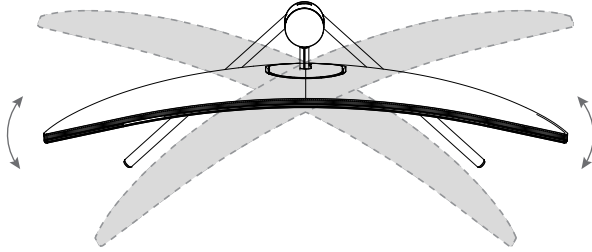

Rotation angle  
 $\pm 15^\circ (\pm 2.0^\circ)$

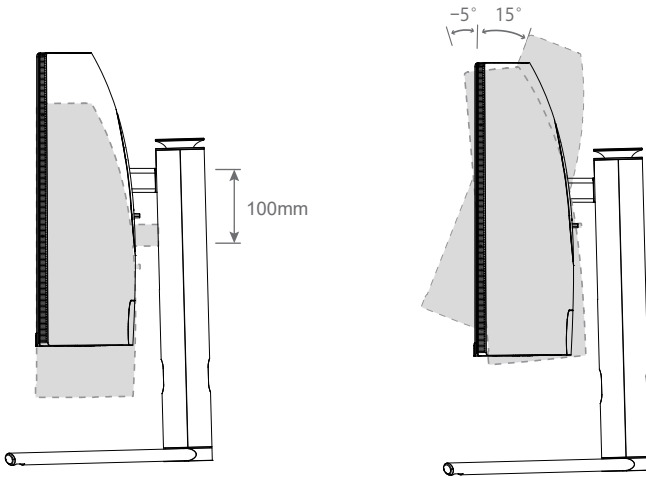

Height adjustment  
100mm( $\pm 5.0$ mm)

Tilting angle  
 $-5.0^\circ (\pm 2.0^\circ) \sim +15^\circ (\pm 2.0^\circ)$

# Instructions

## Description of buttons

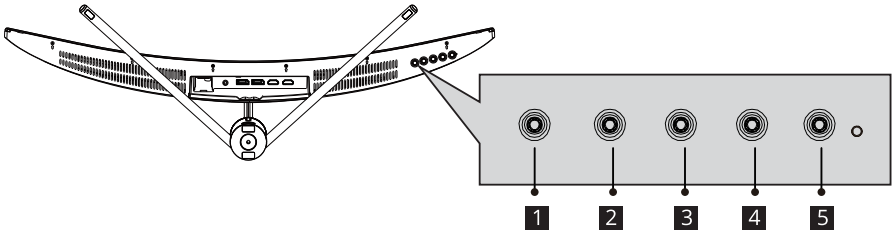

| Button | Function  |
|--------|---|
| 1      | Menu button: Press to enter sub-menus/ quickly enter the main menu.                 |
| 2      | Down button: Press to move down in the menu/quickly adjust the Game Crosshair.      |
| 3      | Up button: Press to move up in the menu/quickly adjust the Contextual Model.        |
| 4      | Exit/hot key: Press to return to the previous menu/quickly adjust the Input Signal. |
| 5      | Power button: Press to turn on/off the monitor.                                     |

## Explanation of indicator light

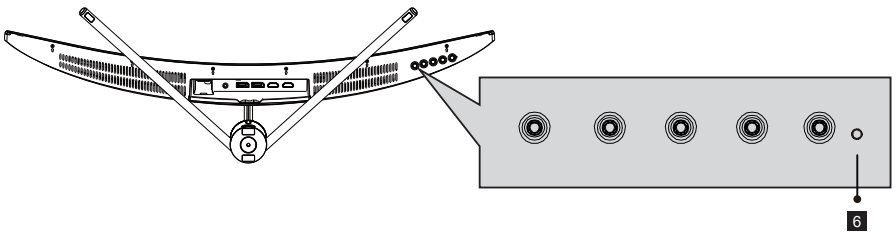

6. Indicator: Steady blue light indicates that power is on and the monitor is operating normally. A red light indicates no video source, no horizontal or vertical signal detected or low voltage. No light indicates a shutdown condition. Make sure your computer is turned on and that all video cables are fully plugged in and/or connected.



# Instructions

## Cabling

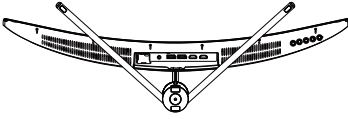

- \* The bottom interface configuration at the back of the varies with products.
- \* Note: If the power cable or signal cable is damaged, you must replace it with special soft cables or special components purchased from the manufacture or maintenance department.

### HDMI Interface

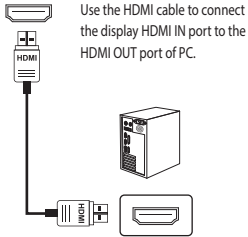

Use the HDMI cable to connect the display HDMI IN port to the HDMI OUT port of PC.

### DP Port

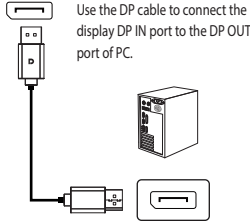

Use the DP cable to connect the display DP IN port to the DP OUT port of PC.

### AUDIO OUT

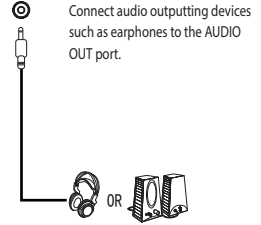

Connect audio outputting devices such as earphones to the AUDIO OUT port.

### AC IN Interface

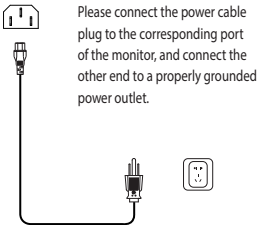

Please connect the power cable plug to the corresponding port of the monitor, and connect the other end to a properly grounded power outlet.

# OSD Menu

- The color and shape of the OSD menu may be slightly different of shown.
- OSD menu may be changed by function improvements.

The screen display (OSD) menu can be used to adjust settings of the monitor and is shown on the screen after the monitor is powered on and the **M** button is pressed.

1. Press the button **M** to activate the browser screen.

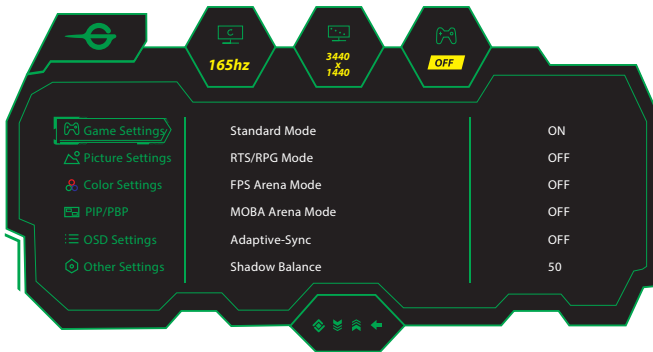

2. Press **▼** or **▲** to scroll through the functions.

- Select the desired function, and press **M** to enter the sub-menu.
- Press **▼** or **▲** to scroll through sub-menus, and press **M** key to select and confirm the desired function.
- Press **▼** or **▲** to select one option, and press **M** to confirm settings and exit from the current menu.

3. Press **E** to exit from the menu screen.

# OSD Menu

- The functions list in this manual are for reference only.

| Main Menu        | Sub Menu           | Option                        |
|------------------|--------------------|-------------------------------|
| Game Settings    | Standard Mode      | Off/On                        |
|                  | RTS/RPG Mode       | Off/On                        |
|                  | FPS Arena Mode     | Off/On                        |
|                  | MOBA Arena Mode    | Off/On                        |
|                  | Adaptive-Sync      | Off/On                        |
|                  | Shadow Balance     | 0-100                         |
|                  | Response Time      | Off/Standard/Fast/Ultrafast   |
|                  | Refresh Rate       | Off/On                        |
|                  | Game Crosshair     | Off/On                        |
|                  | Game Time          | Off/On                        |
|                  | Dynamic Brightness | Off/Normal/Expert/Elaboration |
|                  | HDR                | Off/HDR Standard              |
|                  | MPRT               | Off/On                        |
|                  | Ambient Lighting   | Off/On                        |
| Picture Settings | Brightness         | 0-100                         |
|                  | Contrast           | 0-100                         |
|                  | DCR                | Off/On                        |
|                  | Contextual Model   | Off/On                        |
|                  | Low Blue Light     | 0-100                         |
|                  | Sharpness          | 0-5                           |
|                  | Gamma              | 1.8/2.0/2.2/2.4/2.6/S.curve   |
|                  | Aspect Ratio       | Wide Screen/4:3/1:1/Auto      |
| Color Settings   | Warm               | Off/On                        |
|                  | Natural            | Off/On                        |
|                  | Cool               | Off/On                        |
|                  | User1              | Off/On                        |
|                  | User2              | Off/On                        |
|                  | User3              | Off/On                        |
|                  | Hue                | 0-100(R/G/B/C/M/Y)            |
|                  | Saturation         | 0-100(R/G/B/C/M/Y)            |

# OSD Menu

| Main Menu      | Sub Menu          | Option   |
|----------------|-------------------|--|
| PIP/PBP        | PIP/PBP Mode      | Off/PIP Mode/PBP 2Win 1:1  |
|                | Sub-Signal Source | DP1/DP2/HDMI1/HDMI2  |
|                | Audio Source      | Auto/DP1/DP2/HDMI1/HDMI2   |
|                | PIP Position      | Top Right/Top Left/Bottom Right/Bottom Left  |
|                | PIP Size          | Small/Medium/Large   |
|                | Window Swap       | Off/On   |
| OSD Settings   | Language          | 简体中文/English/한국어 / عربي / Portugues do Brasilazil / Deutsch/Nederland/<br>Suomi/Français/Ελληνικά/Indonesia/Italiano/日本語/Malaysia/Polksie/<br>Português/Русский/Español/ไทย/Українська/ Tiếng Việt/繁体中文/Türkçe |
|                | OSD Time Out      | 5-60   |
|                | OSD H-Position    | 0-100  |
|                | OSD V-Position    | 0-100  |
|                | OSD Transparency  | 0-5  |
|                | Hotkey1 Setting   | Brightness/Contrast/Volume/Mute/Shadow Balance/Game Crosshair/<br>Refresh Rate/Game Time/Contextual Model/PIP/PBP Mode/Input Signal<br>/Dynamic Brightness/HDR   |
|                | Hotkey2 Setting   |  |
|                | Hotkey3 Setting   |  |
| OSD Lock       | Off/On            |  |
| Other Settings | Input Signal      | Auto/DP1/DP2/HDMI1/HDMI2   |
|                | Volume            | 0-100  |
|                | Mute              | Off/On   |
|                | Auto Power        | Off/On   |
|                | Eyeshield Remind  | Off/On   |
|                | Reset             | No/Yes   |
|                | Information       | Input Source: /Resolution: /Mode: /HDR Ver:  |

## Parameters

|                          |               |  |
|--------------------------|---------------|--|
| Product name             |               | Liquid Crystal Display   |
| Screen size              |               | 34inch   |
| Aspect ratio             |               | 21:9   |
| Viewing angle            |               | 178°(H) / 178°(V)  |
| Pixel pitch              |               | 0.2317(H)×0.2317(V)mm  |
| Contrast ratio           |               | 3000:1(TYP)  |
| Color                    |               | 16.7M  |
| Resolution               |               | 3440 x 1440  |
| Refresh rate             |               | 165Hz  |
| Power supply             |               | 100-240V~ 50/60Hz 2.0A<br>The standard voltage and power supply may vary with countries, please refer to the label at the back of the product. |
| Product dimensions       | Without stand | 808.7x363.3x123.2mm  |
|                          | With stand    | 808.7x510.7x256.1mm  |
| Tilting angle            |               | Forward tilting-5°±2.0° ; Backward tilting15°±2.0°   |
| Height range             |               | 100±5mm  |
| Rotation angle           |               | ±15°(±2.0°)  |
| Environmental conditions | Action        | Temperature: 0°C~ 40°C (32°F ~ 104°F)<br>Humidity: 10%~90% RH (non-condensing)   |
|                          | Storage       | Temperature: -20°~ 60° (-4°F ~ 140°F)<br>Humidity: 5%~95% RH (non-condensing)  |



The terms HDMI and HDMI High-Definition Multimedia Interface, and the HDMI Logo are trademarks or registered trademarks of HDMI Licensing Administrator, Inc. in the United States and other countries.



"This device complies with Part 15 of the FCC rules. Operation is subject to the following two conditions:  
(1) this device may not cause harmful interference, and  
(2) this device must accept any interference received, including interference that may cause undesired operation."