

TENWAYS

energized urban ride

Installation
Manual

CGO600

01

Unwrap your TENWAYS e-bike

- (1) Take out the bike, the seatpost, and the tool box.
- (2) Remove (and recycle) all wrapping material.
- (3) Save the bike box and tool box for future use.

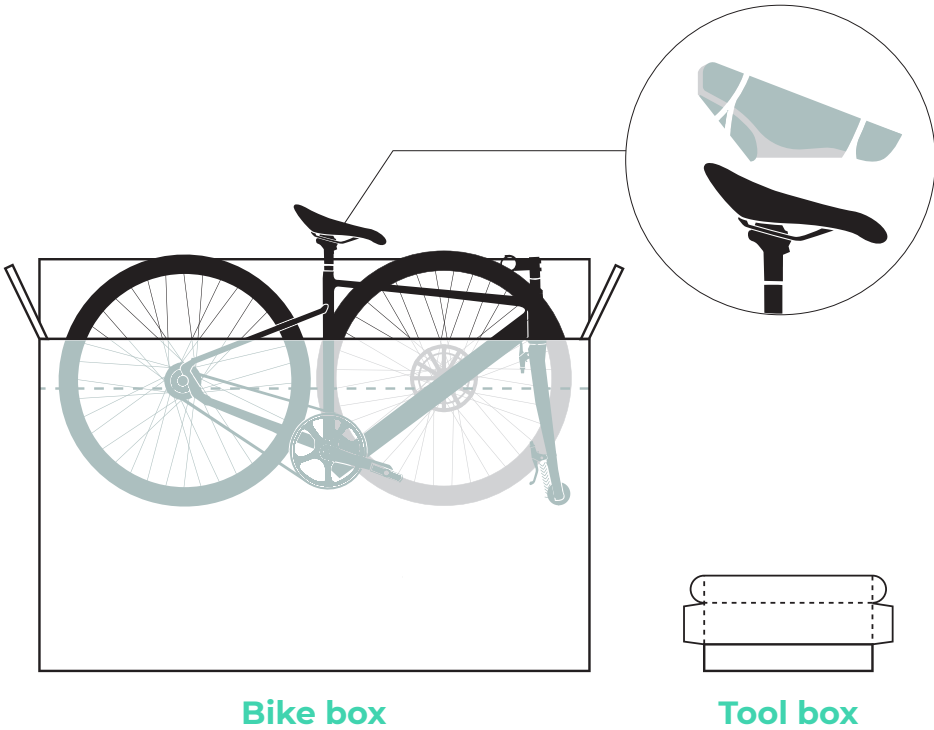

Tool box checklist



10mm
Wrench



15mm
Wrench



3mm
Hex Key



4mm
Hex Key



5mm
Hex Key



Phillips
Screwdriver



Cycling
Pump



Rear Light



Rear Light
USB
Charger



Adapter

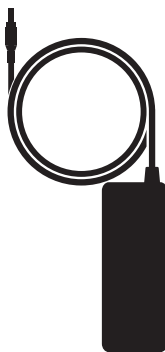

Charger

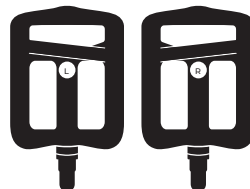

Bicycle Pedals

02

Take out the front wheel

- (1) Take out the front wheel.

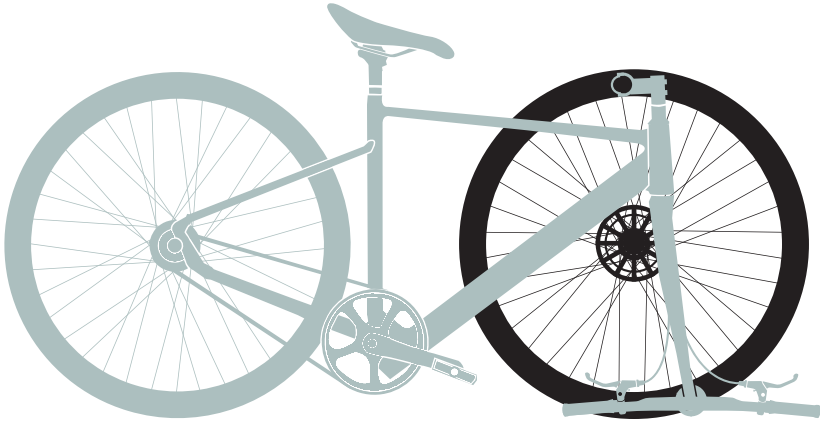

- (2) Remove (and recycle) the plastic covers from both sides of the wheel hub.

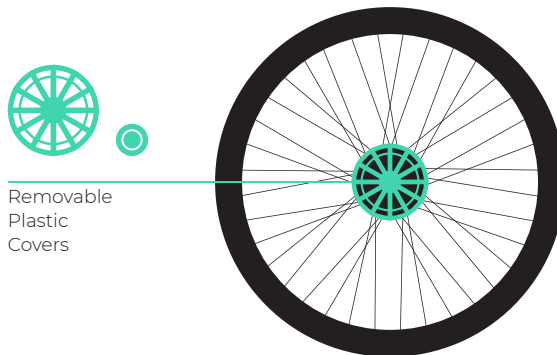

Removable
Plastic
Covers

3

Rotate the stem to the front

- (1) Hold the head tube in one hand.



- (2) Use the other hand to rotate the stem to the front-facing direction.

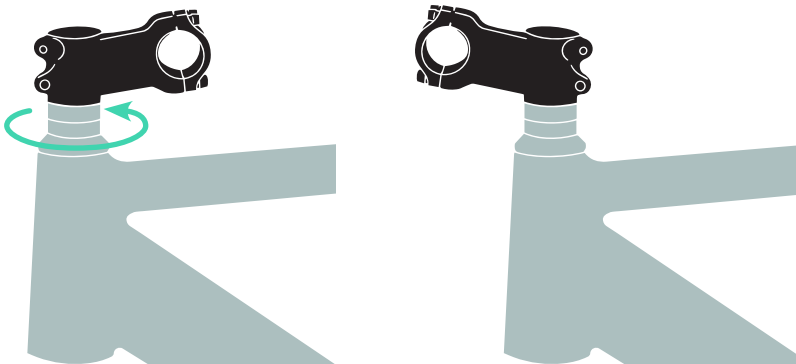

04

Take off the front attachment of the stem

- (1) Use a 4mm hex key to unscrew the 4 handlebar clamp bolts by turning counterclockwise.

⚠ Be careful not to lose the bolt washers.

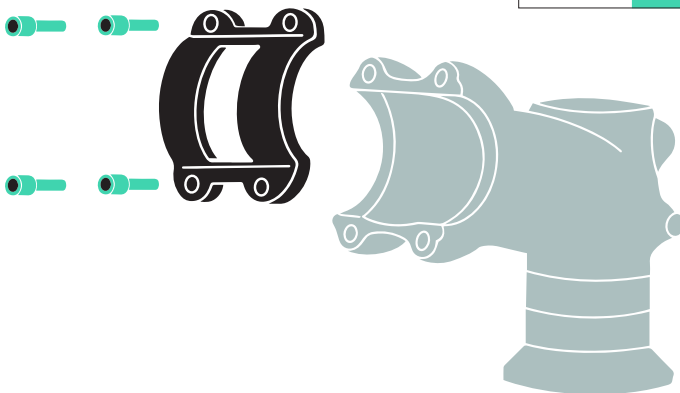
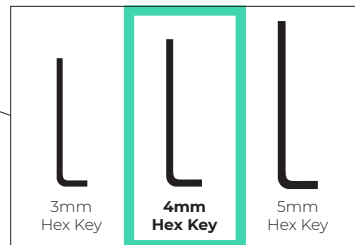
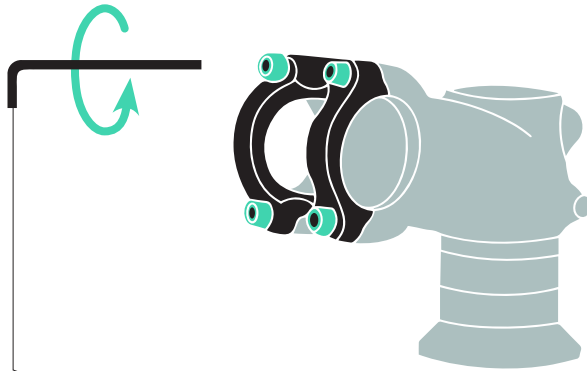

05

Install the handlebar

- (1) Place the handlebar at an appropriate position, make sure the "cross symbol" is located at the center.

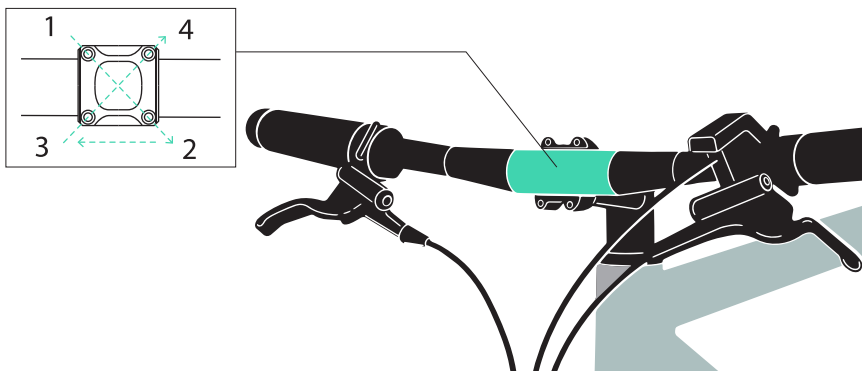

- (2) Use a 4mm hex key to install the 4 bolts by turning clockwise. The sequence is shown in the picture above. Please do not fully tighten them yet.

- (3) Once the bolts and the handlebar are in the right place, tighten the bolts fully with appropriate force.

 The max torque of these 4 bolts is 6Nm. If the handlebar is installed correctly, the brake lever should be 45° to the ground once the front wheel is installed.

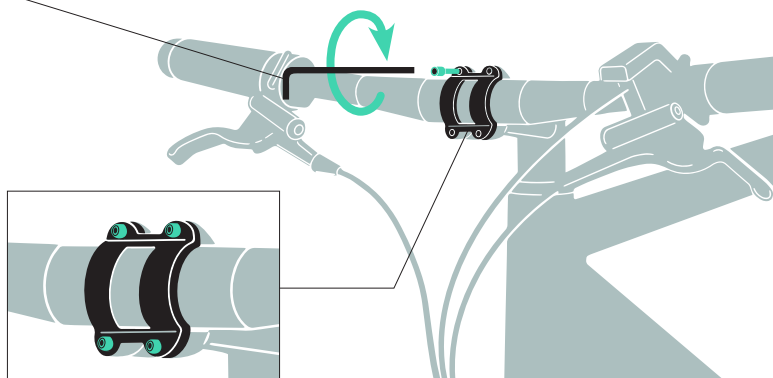

06

Install the front light

- (1) Rotate the front light to the upright position.
- (2) Use the Phillips screwdriver to secure the front part of the light's installation bolt.

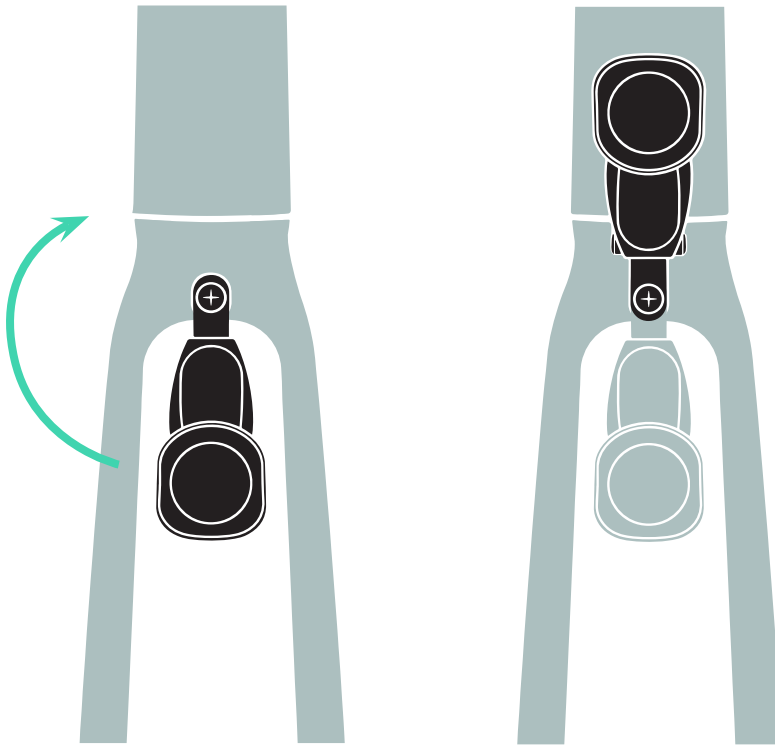

- (3) Use a 10mm wrench to tighten the rear nut by turning clockwise.
- (4) Use a 3mm hex key to tighten the bolt at the middle of the light.

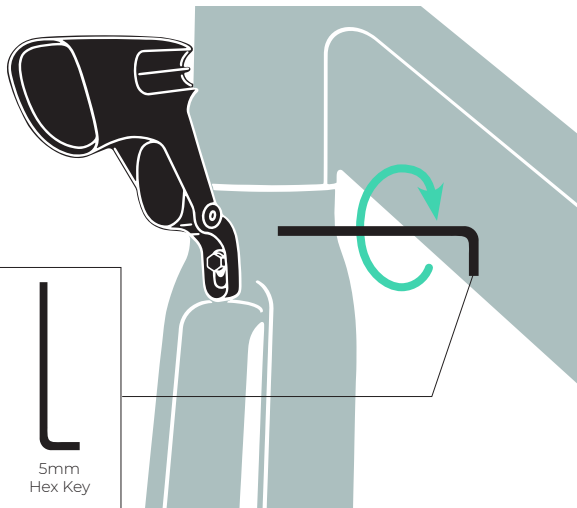
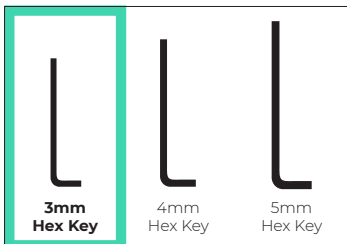
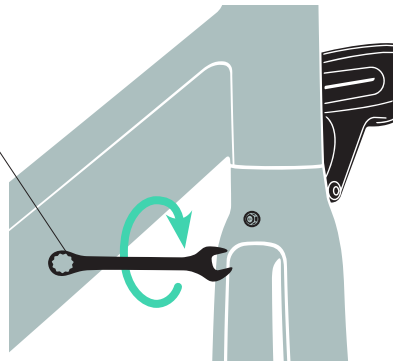
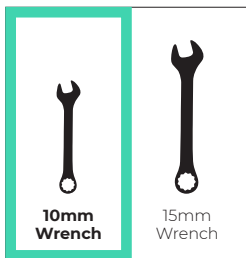

07

Take out the front wheel's quick release

- (1) Open the front wheel's quick release.
- (2) Loosen the adjusting nut, and remove the plastic cover.

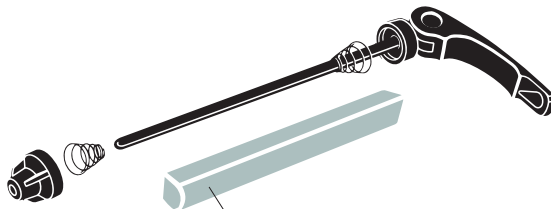
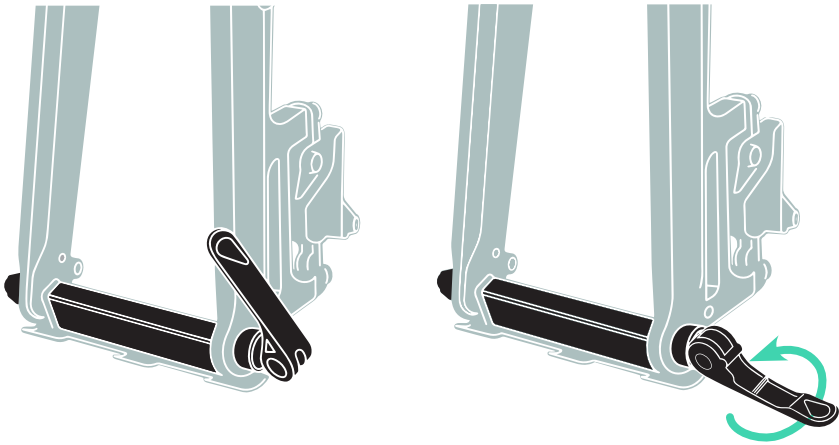

You will no longer need this

8

Remove the plastic insert from the brake caliper

- (1) Please keep the plastic insert for future use. It can help to protect the brake caliper when the front wheel is detached.

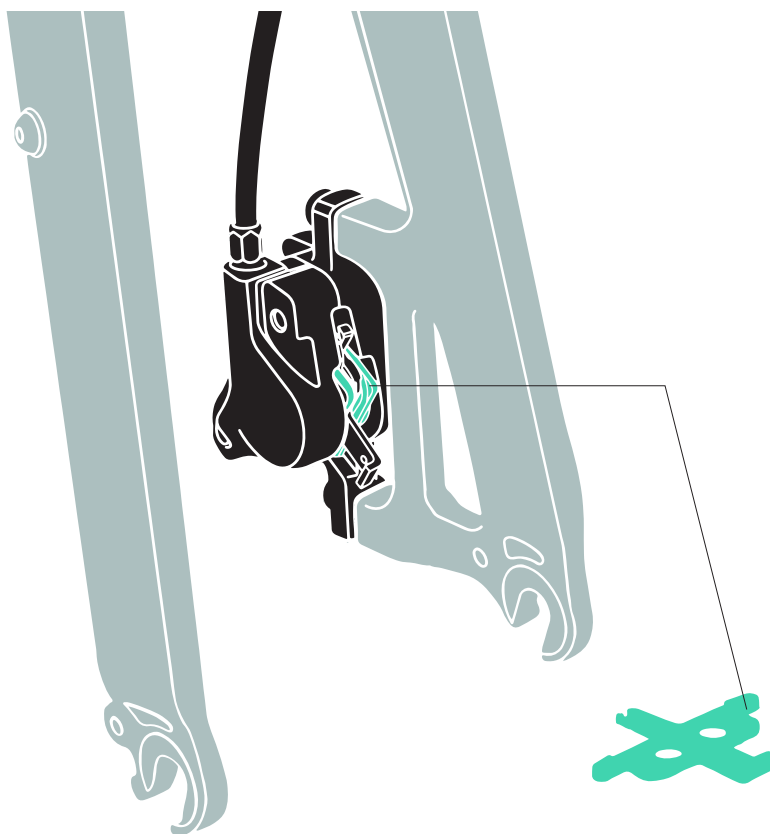

09

Install the front wheel

 This step is extremely important, so please read carefully.

- (1) Move the quick release lever to an open position, and firmly install the front wheel.

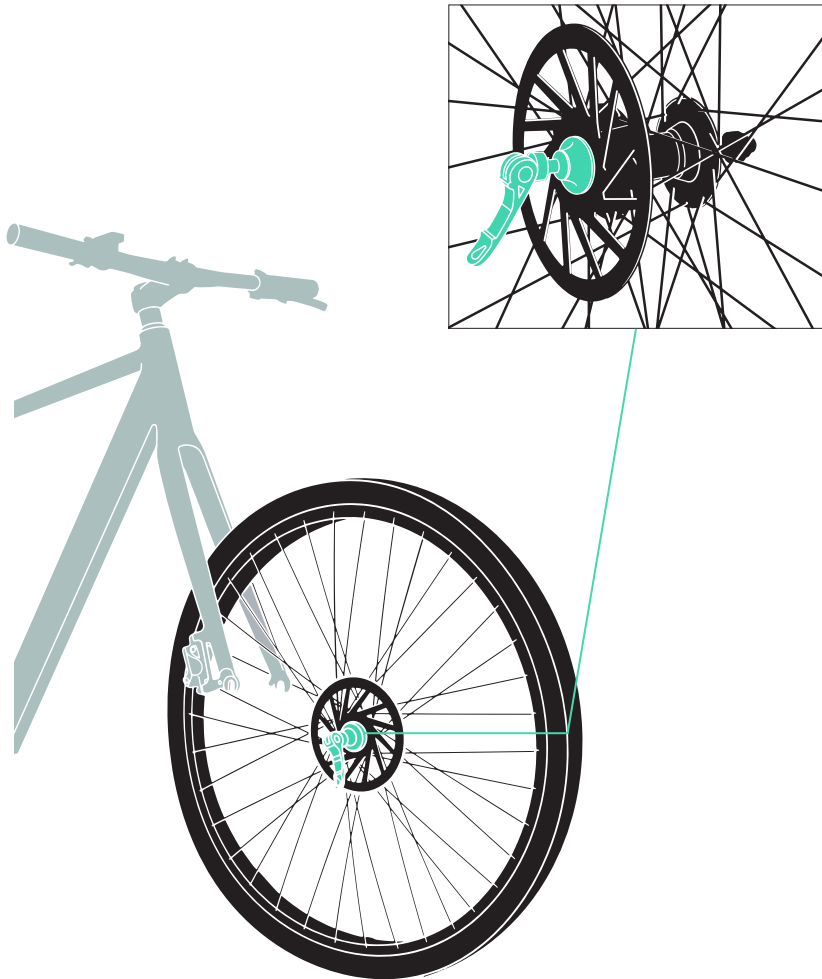

 This step is extremely important, so please read carefully.

- (2) Open and close the quick release lever with one hand, while gradually tightening the adjusting nut clockwise with the other hand.
- (3) Continue tightening the nut until you feel resistance from the lever when it reaches a parallel position with the hub.
- (4) Grip the front fork with your fingers and use the palm of your hand to apply force to the quick release lever. It should take considerable force to tighten the lever completely.
- (5) Once fully closed, the lever should be at a position shown in the picture below.

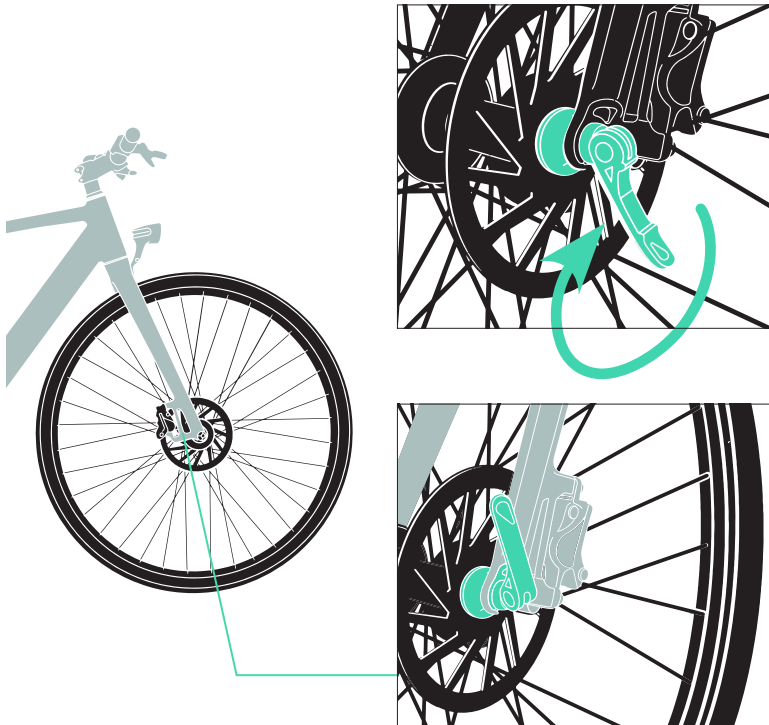

Check The Di

- (1) Loosen the bolts of the brake caliper with a 5mm hex key, so it can be moved slightly.

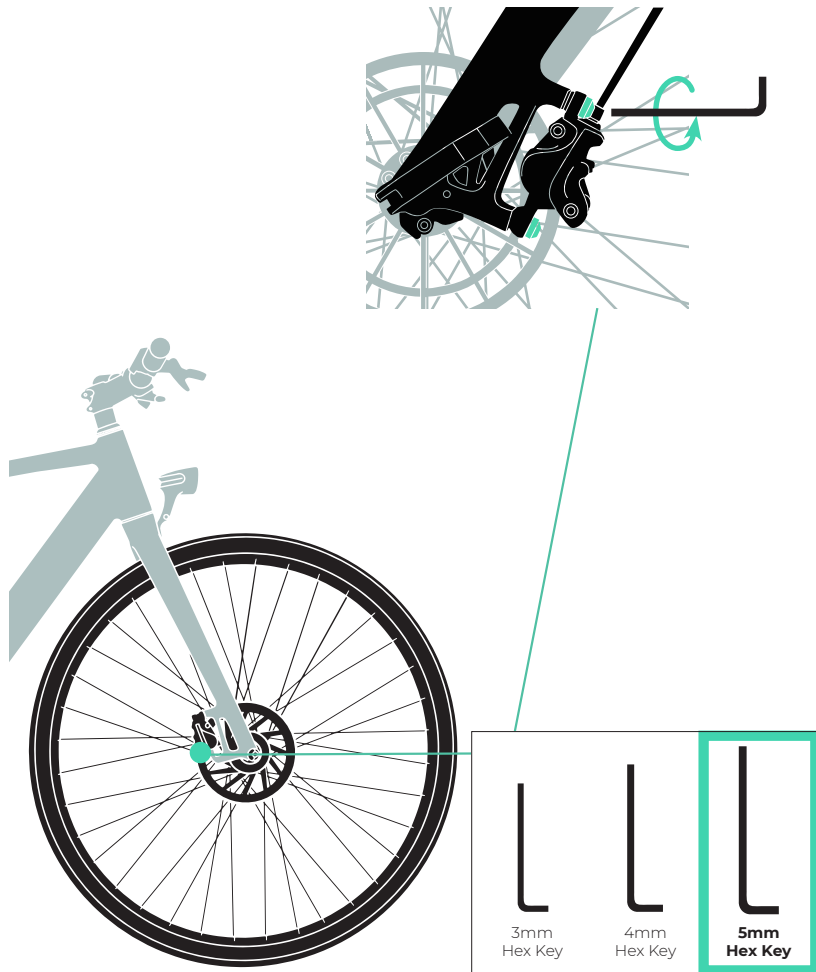

sc Alignment

(2) Squeeze the front brake lever 5 times

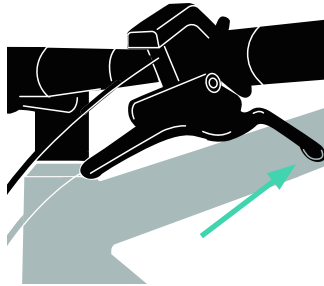
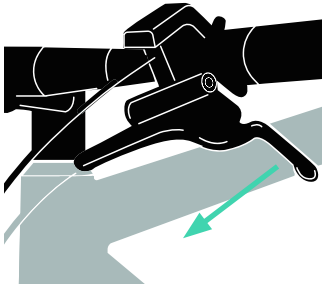

(3) Hold down the front brake lever, then tighten the bolts on the brake caliper with a 5mm hex key.

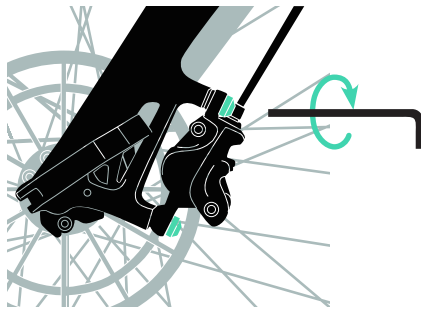
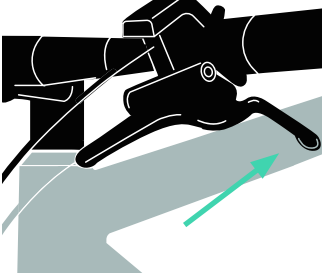

(4) Spin the front wheel to check if there is friction noise.

(5) If there is friction noise, please loosen the bolts on the brake caliper.

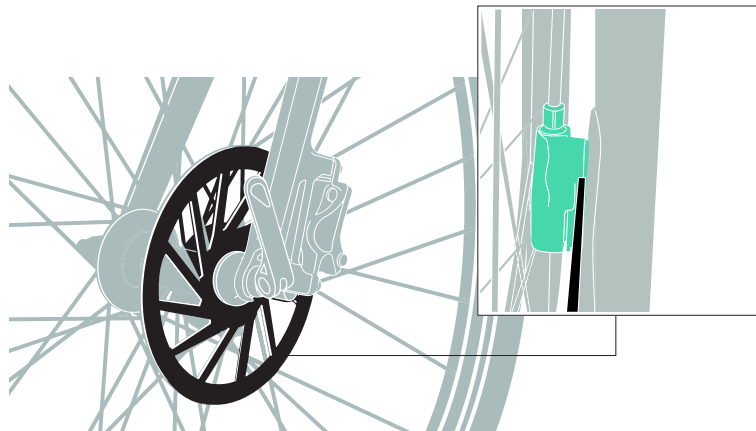
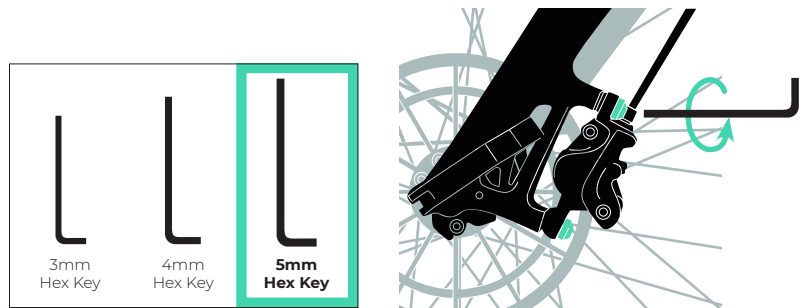

Manually move the brake caliper, so that the brake disc is centered.

(6) Then tighten back the bolts securely, while holding down the front brake lever.

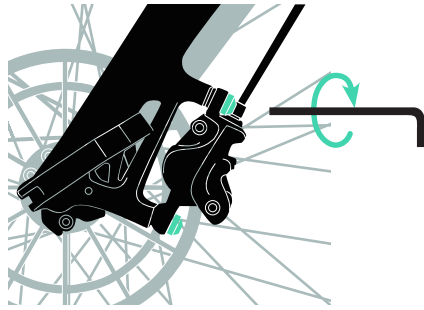
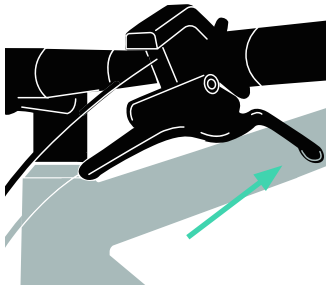

10

Install the pedals

- (1) The pedals are marked with "R" (Right) and "L" (Left). This refers to the two sides of the e-bike. The R pedal goes to the side of the carbon belt, and the L pedal goes to the other side.

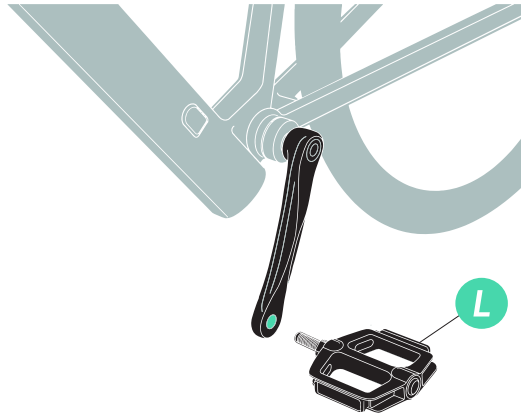
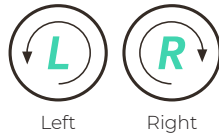

- (2) Manually install the left pedal by turning counterclockwise. Tighten the pedal securely with a 15mm wrench.
- (3) Manually install the right pedal by turning clockwise. Tighten the pedal securely with a 15mm wrench.

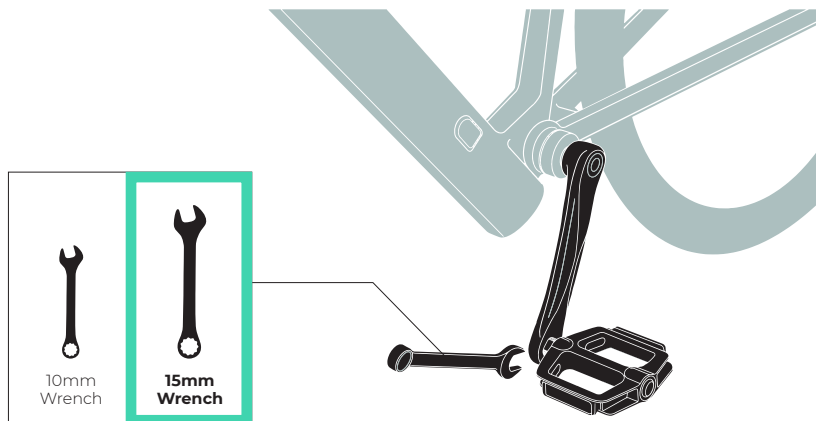

11

Install the saddle and the rear light

- (1) Loosen the adjusting nut and open the quick release of the seat tube.
- (2) Insert the seatpost into the seat tube, and close the quick release securely.
- (3) Using the strap, attach the portable rear light securely to the seatpost.

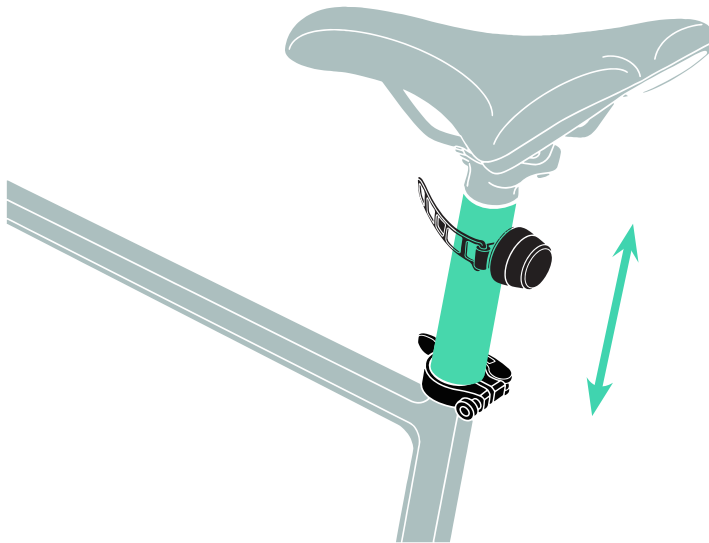

12

Adjust the handlebar

- (1) Holding the front wheel tightly between your legs, adjust the handlebar's alignment with your hands. Position the handlebar perpendicular to the front wheel.
- (2) Use a 4mm hex key to tighten the 2 bolts on the stem securely by turning clockwise.

 If the stem is not installed securely, you will be at the risk of a sudden loss of control, which could result in severe body injuries.

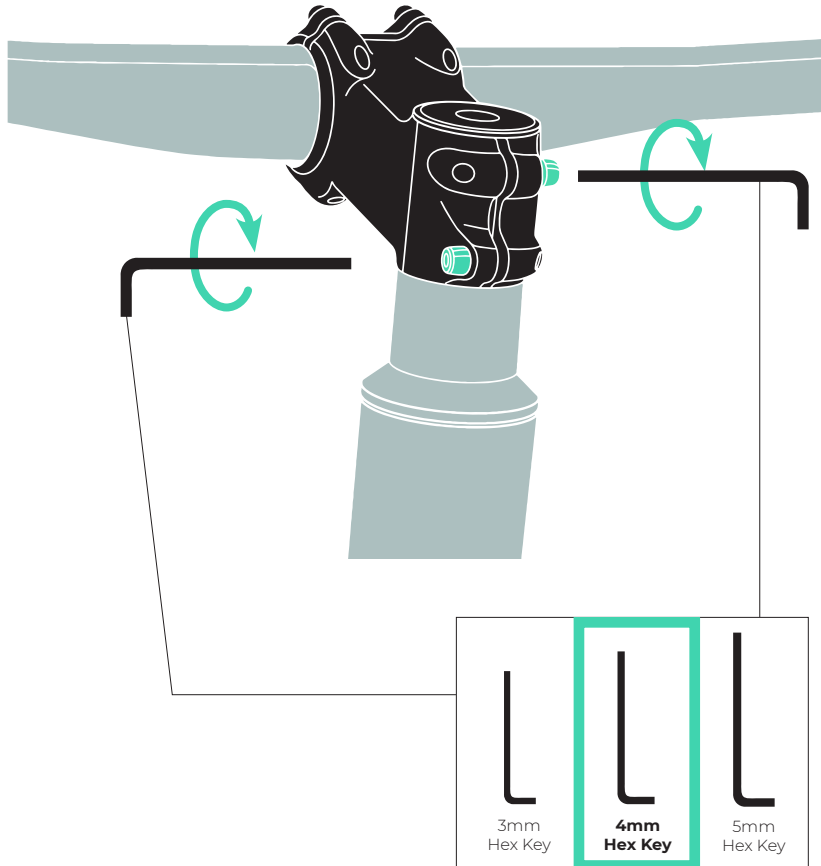

Display Panel



Display Panel - set the password

The default password is '0000'

- (1) After turning on the panel, wait for about 20 seconds.
- (2) Long press the M button to see the menu.
- (3) Use the up and down buttons to select "password", and press the M button.
- (4) Use up and down buttons to change the number for each digit.
- (5) Long press the M button to exit the password page.
- (6) Exit to the main page to save the new password.

13

How to connect to the TENWAYS App



(1) Turn on your smartphone's Bluetooth.

(2) Open your TENWAYS App.

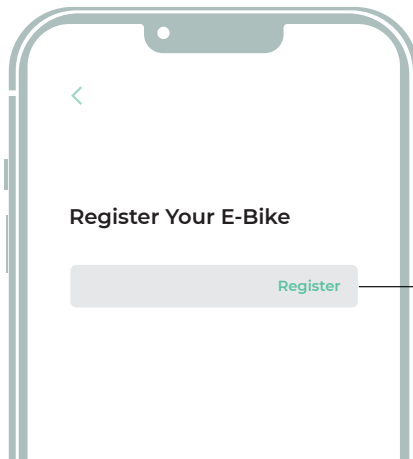
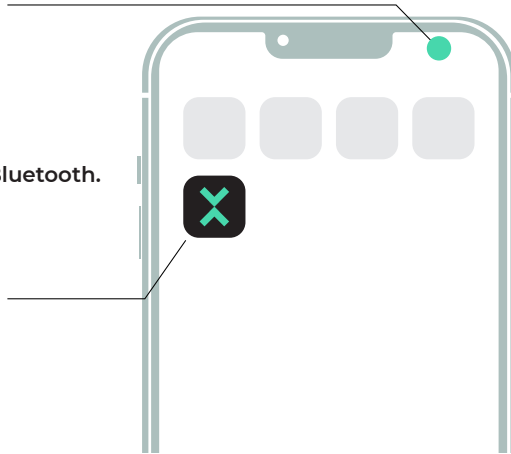

(3) Tap "Register"

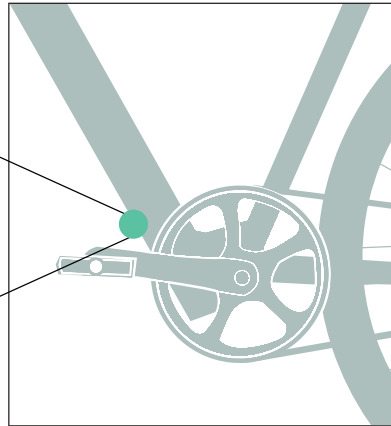
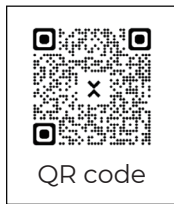

(4) Scan the QR code on the downtube.



(5) Fill in your e-bike's color and size, and give it a special name.

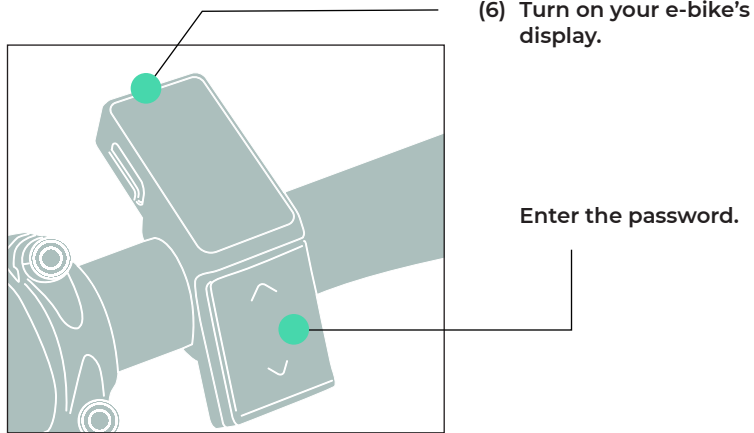

(7) The App will automatically connect in about 10 seconds.

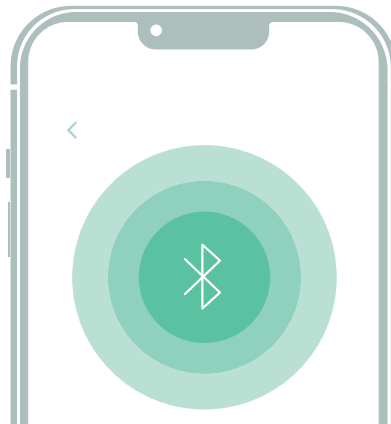

Before You

Check bolts and nuts

Check and tighten these bolts and nuts properly before your first ride, with provided tools.

- The bolt at the top of the handlebar, with a 4mm hex key.
- The 2 bolts on the stem, with a 4mm hex key.
- The bolts on the brake levers, with a 4mm hex key.
- The bolts on the brake caliper, with a 5mm hex key.
- The five bolts around the crankset, with a 5mm hex key.

Please check and tighten these bolts again after riding 200km. Perform the same checks every 1000km after this or every 600km in complex road conditions.

Check the front wheel

- Open and close the quick release lever, and see if it is securely locked. A properly locked quick release requires considerable effort to open.
- It is imperative to check the condition of the front wheel before every ride, especially after you park the bike in public areas.

Check the brakes

- Before your first ride, ensure that the brake lever is securely attached to the handlebar, and the brake caliper is securely attached to the front fork.
- When braking with both brakes on a flat road at a speed of 16km/h, the braking distance should be $\leq 5m$. When braking with the rear brake only, the braking distance should be $\leq 10m$. If you find the braking power insufficient, please contact the TENWAYS customer support team as soon as possible.

Check the tire pressure

- Before your first ride, pump up the tires to 50-75 psi.

ir First Ride

Set the the seatpost

- When properly adjusted, the seatpost should be at your hip's height.
- While seated on the saddle, and with one pedal at the lowest position, if you can place your heel on that pedal with an almost fully extended leg, your seatpost is at the correct height.
- Make sure the seatpost is not in a position beyond the minimum insertion mark.

Charge the battery

- Before your first ride, please charge the battery to full. Your e-bike will not arrive fully charged for safety reasons.

Install the TENWAYS App

- The TENWAYS App can be downloaded from the App Store and Google Play.
- Once connected, you can record every ride with the TENWAYS App.

Safe Ride

General guidance

- Always wear a protective helmet that is in compliance with local laws and regulations.
- Always keep your two feet on the pedals.
- Use appropriate speed, and do not suddenly increase or decrease your speed.
- Keep a decent distance from other bikes and cars.
- Stay focused when riding the bike.
- Avoid riding the bike in extreme weather conditions, or when you feel exhausted.
- Fully comply with local transportation laws and regulations when riding the e-bike.

Wet weather riding

It becomes harder to brake in wet weather, so please reduce your riding speed.

Night riding

- Before riding in the night, carefully check if the front and rear lights, as well as the reflective strips on the side of the wheels are in good condition.
- We highly recommend you to wear reflective clothing when riding in the night.
- Do not cover the front and rear lights, or the reflective strips with your clothing or luggage.
- Ride slowly.
- Avoid crowded streets, or complex road conditions.

Maintenance

Keep your bike clean

- Regular cleaning is important for keeping your e-bike in top shape. Preventing the accumulation of dirt will keep the moving parts running smoothly and noise-free.
- Give your e-bike a good cleaning every once in a while with soapy water or clear water. The display and the motor are both waterproof.
- If your e-bike is covered by mud, wait for it to dry, and then clean it with a cleaning brush and soapy water.
- If there is dust on the carbon belt, use clean water to rinse the belt's top and bottom, and wipe it dry.
- We highly recommend you clean the e-bike after each 200km of riding. If you plan to leave the e-bike idle for an extended time, please clean it before doing so.



Do not use a water hose to clean the e-bike.

Battery care

- Proper storage and handling of the battery can greatly extend its useful life.
- Make sure to only use the charger provided by TENWAYS.
- We recommend you charge the battery in a dry environment at a temperature between 20°C-25°C.
- The battery should not be over-charged or over-discharged. We recommend a charge/discharge cycle between 10% and 90% state of charge.
- If you plan to leave the e-bike idle for an extended time, charge the battery up to 50%-70% state of charge.
- The battery needs a charge/discharge cycle at least once every 3 months.
- Lithium-ion batteries are impacted by temperature, so do not worry if performance drops on colder days. Your TENWAYS e-bike will regain full performance once the days get warmer.

Maintenance

Long-term storage

- The recommended storage environment is of 0°C-25°C temperature, and 45%-85% humidity.
- Pump up the tires to 50%-60% of the recommended tire pressure.
- Avoid direct exposure to rain and sunlight.
- Perform regular cleaning and take decent care of the battery.
- Before reusing the bike, make sure to check the battery state of charge, tire pressure, the tightness of the bolts, and the condition of the brakes.

Keep the bolts tight

It is important to keep the bolts tight all the time. For the process and frequency of checking the bolts, please kindly refer to Page 26.

Brake maintenance

- The brakes should be checked regularly. They should be clean and adjusted to offer the best stopping power.
- The brakes can become less efficient over time due to wear and tear. We recommend you get your brakes checked, fixed, or replaced if necessary by professionals when you find the stopping power inefficient.
- Squeezing on the brake levers should feel solid. The brake levers should never touch the handlebars.
- Check on the brake disc and brake caliper every few weeks. There should not be any dirt or oil on the brake disc and brake caliper. Oil is usually the cause of squeaking noises.
- Check the wear and tear of the brake hoses regularly and get professional help if you find anything broken or worn out.

Professional maintenance schedule

It is important to perform a professional check on the e-bike regularly, with the help of reputable local bike shops. We recommend you to check 2-3 times every 3 months, or for every 1000km of ride. The following items should be checked:

- The brake performance.
- The bolts at crucial positions, especially the five bolts around the crankset.
- The wear and tear of the cartridge headset.
- The wear and tear of the bearing of the front wheel hub.
- The wear and tear of the connecting points of the pedals.
- The wear and tear of the tire's outer housing, walls, and tread.
- The internal connection of all the core electric components.

Frame number

- The frame number is a QR code located on the downtube, near the bottom bracket.
- Use your smartphone to scan the QR code, and get access to the 15-digit frame number.
- We would highly recommend you to apply for suitable insurance with the frame number.

Warranty

- This product has passed the EN15194-2017 electrically power-assisted cycles regulations.
- All original components are covered by warranty for a period of two years from the date of delivery.
- Claims under this warranty must be made directly to TENWAYS and proof of purchase is required.
- The warranty applies to original owners and is transferable to further owners.
- The warranty does not cover:
 - (1) An incorrect assembly or installation of the product by the user.
 - (2) An improper or negligent use, operation or modification of the product.
 - (3) Maintenance process contrary to the maintenance instructions of the product (e.g. lack of maintenance of the brakes).
 - (4) Normal wear and tear.
 - (5) Defects inherent to the normal useful life or service life of the product.
 - (6) Damages or defects due to accidents.

Warnings

- Do not tamper with any components of the e-bike. The design of the TENWAYS e-bike is based on relevant safety regulations and has been tested many times. The users are responsible for any damage resulting from tampering with any components.
- The e-bike is designed to withstand a maximum weight of 120 kg. It is not built for carrying cargo or passengers. Please do not install any child seating or cargo carriers.
- Do not hang any bags, umbrellas or other heavy or big objects on to the handlebar of your e-bike.
- Do not wear long skirts or ponchos, and do not hang long strings, bands or the like on to your e-bike during riding. There is the risk of getting caught in the wheels or in the drive system.
- Take care when riding in wet and slippery conditions. Ride slowly and gently apply force to the brakes to accommodate a longer stopping distance.
- Do not modify your bike with any accessories/modifications that will void the warranty. This may lead to malfunctioning and/or unapproved public road usage.
- For your safety, please do not touch the disc brake after braking as it heats up during the braking process.
- Do not ride too fast on slopes or uneven ground.
- Do not ride under the impact of alcohol, drug or any intoxicating substances.
- Do not overload the motor for an extended time.
- Do not place the e-bike near strong magnetic fields.
- Do not use the e-bike for any purpose that could cause harm to the life and property of you and the others.



EPAC according to EN15194

tenways.com