

Top View

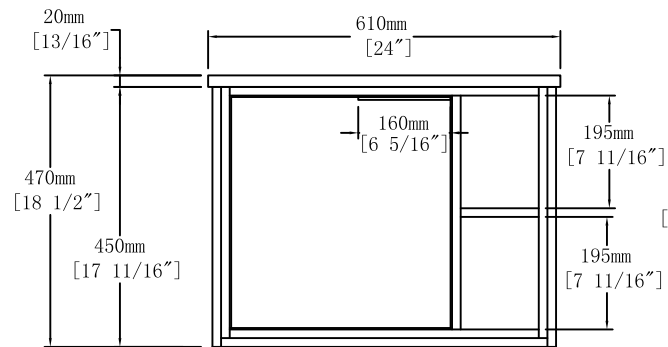

Front View

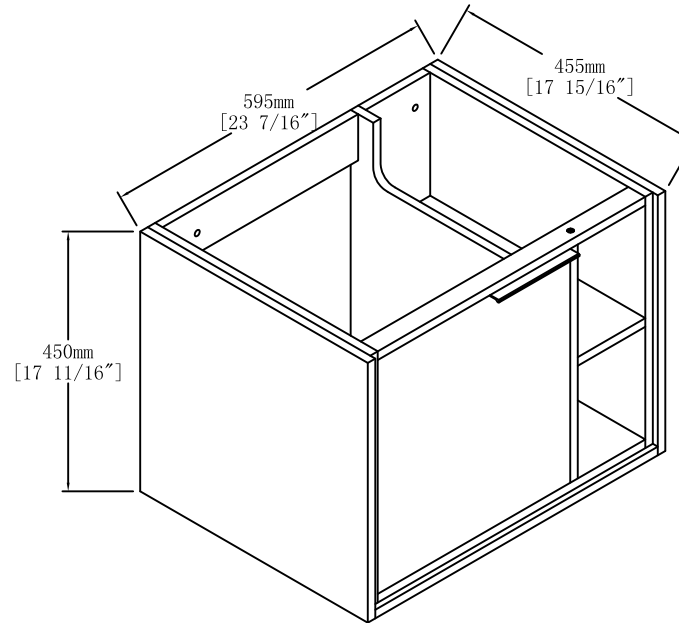
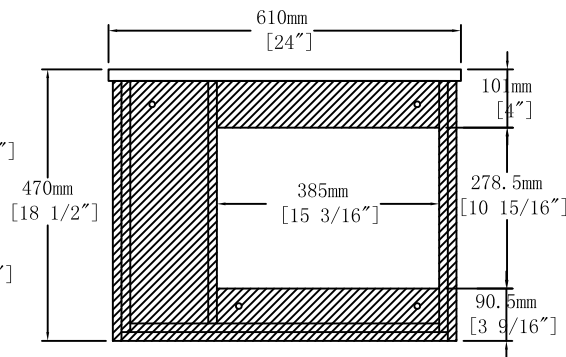

Back View

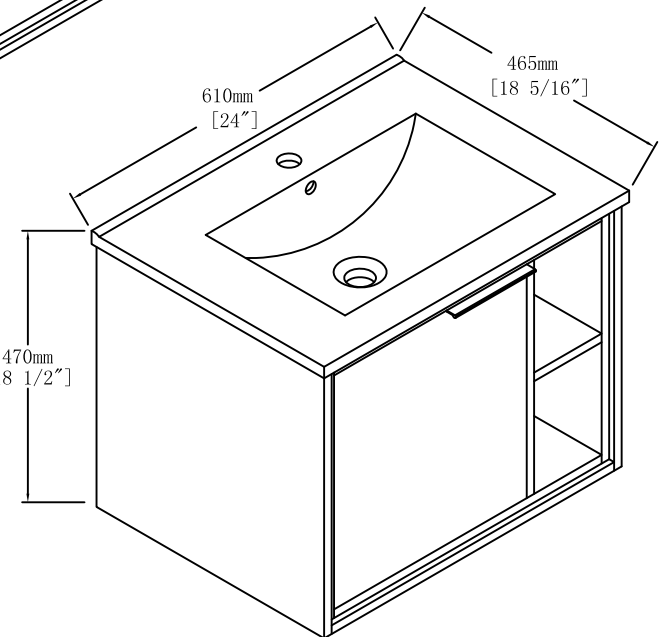

Item NO.	BV C07824	Version	V1
Project		Date	2023-12-4