

YORK[®]

ASPIRE 420

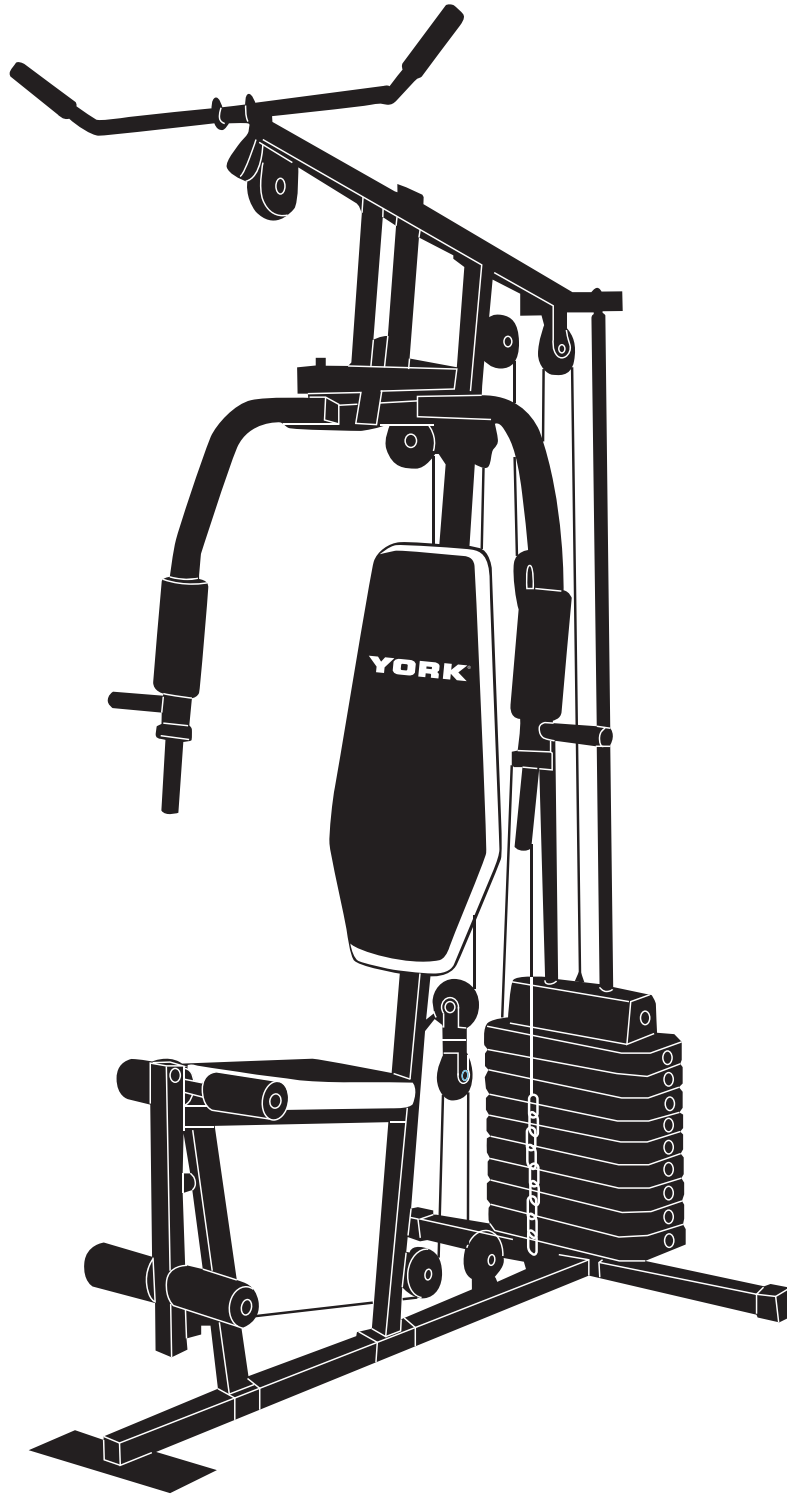

YORK[®]
FITNESS

YORK ASPIRE 420
HOME GYM
ITEM #43420
OWNER'S MANUAL

BEFORE YOU START

PLEASE READ THIS INSTRUCTION MANUAL BEFORE YOU BEGIN ASSEMBLY. Great care has been taken to design these instructions and following them will help you with quicker assembly and minimize the risk of injury.

It is important that you keep these instructions for future reference.

This list is not exhaustive - You are responsible for your own safety!

- Assemble the product on a level surface
- You will need at least one person to help you assemble this unit.
- Always use the product on a level surface, ensure that the product is stable before use.
- Always ensure that the equipment has adequate space on each side and front (the back can be near to a wall).
- Replace defective components immediately, and/or keep the equipment out of use until it is repaired.
- Use only the adjustment settings as described in the instructions. Always use the correct adjustment pin and/or locking devices.
- Always check that any pins / fixings are tight and secure before use and / or after adjustment.
- Never leave any adjustment devices projecting from the product.
- Always consult your doctor before undertaking any exercise program.
- Always wear suitable clothing and footwear e.g. tracksuit / shorts / training shoes
- Remove all personal jewelry before exercising.
- Ensure you warm-up well before using the equipment as this will help to prevent muscle strain.
- After eating, allow 1-2 hours before exercising as this will help to prevent muscle strain.
- Injuries to health may result from incorrect or excessive training.
- Never overload the equipment - the maximum user load is displayed in these instructions and on the product label.
- We recommend that you do not lift weights alone. There should be somebody there to assist you.
- Never use the equipment in any other manner other than the ways explained in these instructions and/or any wall-chart supplied.
- Parents and others in charge of children should be aware of their responsibility, because the natural play instinct and the fondness of experimenting of children can lead to situations and behavior for which the training equipment is not intended.
- If children are allowed to use the equipment, their mental and physical development and above all their temperament should be taken into account. They should be controlled and instructed in the correct use of the equipment.
- The equipment is under no circumstances suitable as a children's toy.
- Children should not be allowed on, or around the equipment - especially when it is not in use.
- This product has been tested for use in a home environment and is warranted for In Home, personal, family or household use.
- Due to our continuous policy of product development, York Fitness reserves the right to change specifications without notice.

CAUTION! The instructions must be followed carefully in the assembly, use and maintenance of your equipment. The warranty does not cover damage due to negligence of the assembly, adjustment and maintenance instructions described herein.

THIS PRODUCT IS NOT SUITABLE FOR THERAPEUTIC PURPOSES.

**100KG USER WEIGHT
150KG TRAINING WEIGHT**

TOOLS AND CONSUMABLES

- 2 x 14-17mm double ended spanner
- 2 x 17-19mm double ended spanner
- 1 x Wrench 5mm
- Pliers should not be used!

CUSTOMER SUPPORT

Should you require any assistance regarding this product please gather the following information and then contact us using the details below:

- Serial No. - This can be found on the sticker below, located as indicated.
- Original purchase date
- Place of purchase
- Information about the place and conditions of use
- Precise description of the issue / defect

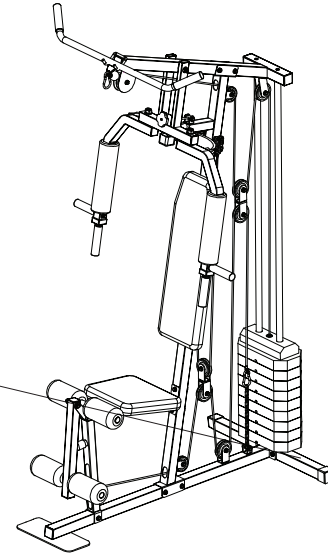
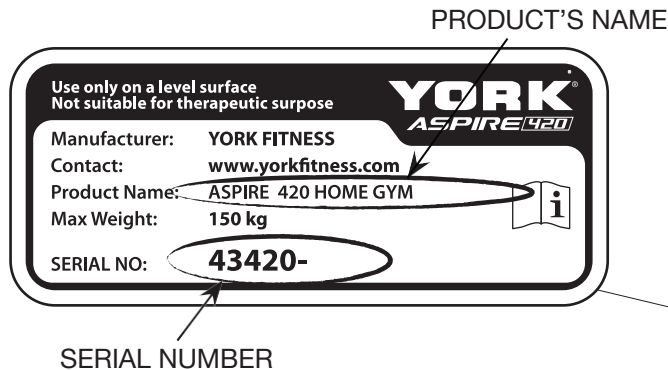

This product label is an example only, it is not the real product name and serial number of the item you have bought.

IMPORTANT!! - Please retain your sales receipt, York Fitness Customer Care may request proof of purchase to validate eligibility for warranty service. Warranty cover starts from the date shown on the proof of purchase.

CARE & MAINTENANCE

- Always place the equipment in a dry environment.
- Use a warm, damp cloth to keep the product clean.
- The safety level of the equipment can be maintained only if it is regularly examined for damage and wear at the start of every use. This includes any nuts, bolts, moving parts, bushes etc.
- Always replace damaged / worn components with original parts from the manufacturer.

PREPARE YOUR WORK AREA - It is important you assemble the product in a clean and uncluttered space.

WORK WITH A FRIEND - We recommend you have someone assist you with the assembly as some of the components are quite heavy.

UNPACK THE CARTON - Remove all the parts and lay them out on the floor.

CHECK TO MAKE SURE YOU HAVE ALL PART, NUTS, BOLTS... ETC, BEFORE YOU START ASSEMBLY.

IF YOU ARE MISSING ANY PARTS AND THE BOX WAS UN-OPENED WHEN YOU LEFT THE STORE, PLEASE CONTACT YORK CUSTOMER SERVICE (CONTACT INFORMATION ON THE BACK OF THE MANUAL).

YORK
ASPIRE 420

EXPLODED DRAWING / PART LIST

REF.	DESCRIPTION	QTY
1	Rear Base Frame	1
2	Front Base Frame	1
3	Weight Guide Tube	2
4	Front Support Frame	1
5	Selector Shaft	1
6	Leg Extension Frame	1
7	Seat Base Frame	1
8	Support Frame	1
9	Upper Cross Beam	1
10	Press Bar	1
11	Left Butterfly Arm	1
12	Right Butterfly Arm	1
13	Pulley H	1
14	Single Pulley Block	2
15	Reverse U	1
16	Lat Bar	1
17	Foam Tube	2
18	Handle Tube	2
19	Tobacco-pipe	1
20	Poohook	2
21	Weight Selector Pin	1
22	Rubber Ring	2
23	Top Weight Plate	1
24	Weight Plate (10LB)	9
25	Wrench	1
26	Big Washer	1
27	Selector Shaft Pin	1
28	Seat Cushion	1
29	Back Cushion	1
30	Leg Foam Roller	4
31	Arm Foam Roller	2
32	Pulley (3.5")	12
33	Pulley Cover	2
34	Plum Blossom Nut	1

REF.	DESCRIPTION	QTY
35	Upper Cable (Length: 2870 mm)	1
36	Lower Cable (Length: 3400 mm)	1
37	Butterfly Cable (Length: 2750 mm)	1
38	Oil Bushing (Small)	2
39	Oil Bushing (Big)	4
40	Select Shaft End Cap	1
41	Countersink Head Bolt (M8x25mm)	4
42	Chain (Length: 265 mm)	1
43	Bumper	1
44	Selector Shaft Bushing	1
45	Round Cap (ø25mm)	1
46	Handle Grip	6
47	Square End Cap (ø38mm)	8
48	Square End Cap (ø45mm)	2
49	Square Cap (ø38mm)	3
50	Square End Cap (ø20x40mm)	2
51	Middle-empty Cap (ø38 x ø26)	2
52	Round End Cap (ø25mm)	4
54	Hex Bolt (M12x120mm)	1
55	Hex Bolt (M10x65mm)	2
56	Hex Bolt (M10x60mm)	11
57	Hex Bolt (M10x45mm)	12
58	Hex Bolt (M8x20mm)	2
59	Hex Bolt (M8x50mm)	2
60	Hex Bolt (M8x40mm)	2
61	Hex Bolt (M8x25mm)	1
62	Hex Bolt (M8x15mm)	4
63	Washer (M12)	4
64	Washer (M10)	50
65	Washer (M8)	14
66	Nylock Nut (M12)	3
67	Nylock Nut (M10)	25
68	Nylock Nut (M8)	3

EXPLODED DRAWING / PART LIST

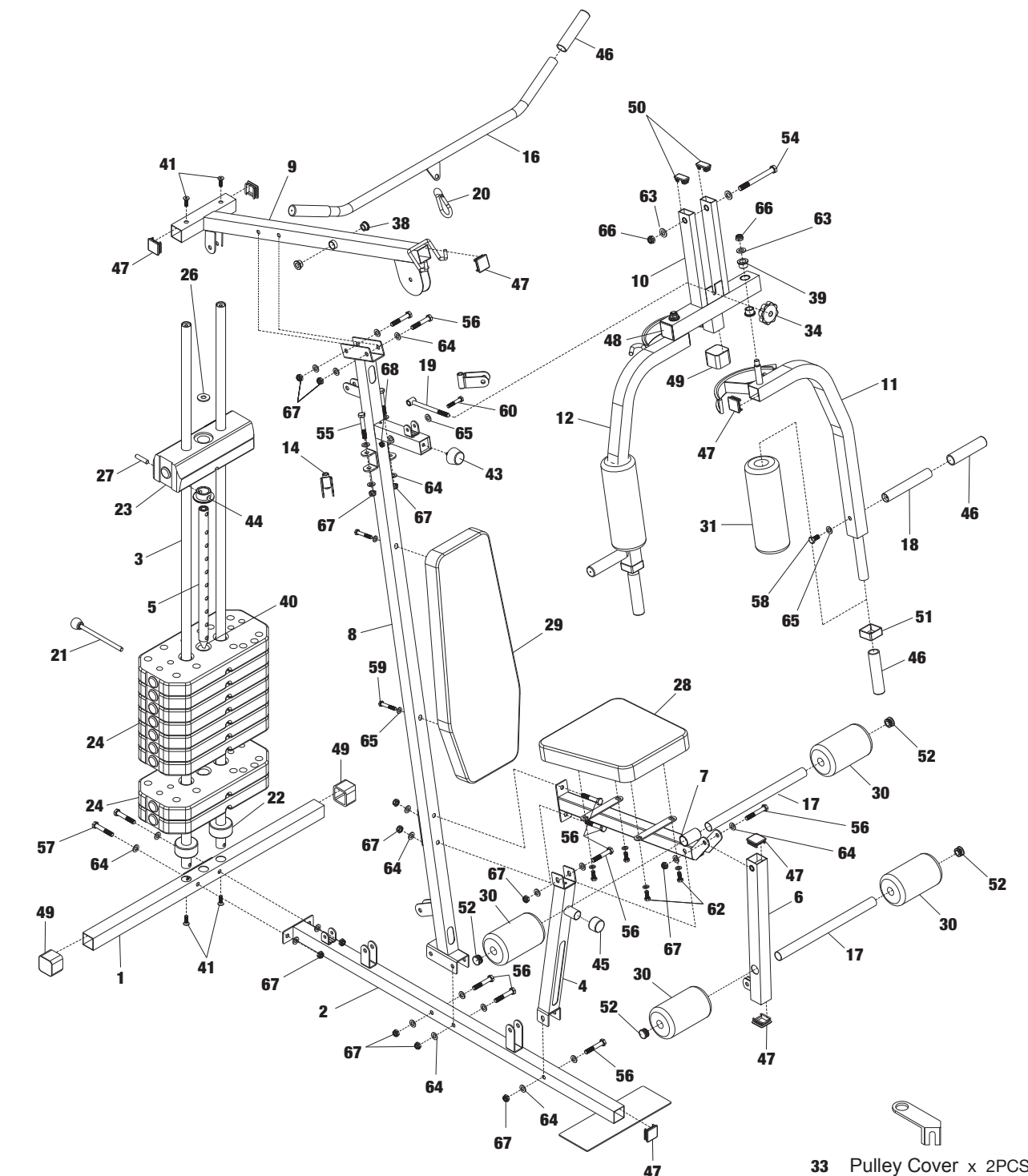

 35 Upper Cable x 1PC

 36 Lower Cable x 1PC











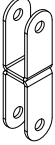
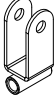
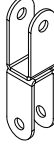
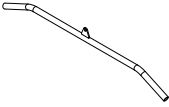
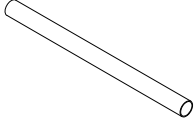

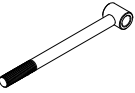

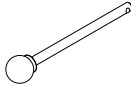

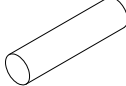
 37 Butterfly Cable x 1PC

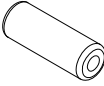
 33 Pulley Cover x 2PCS



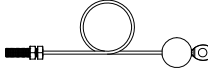
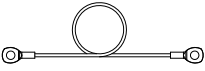
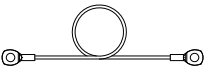











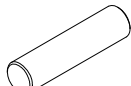

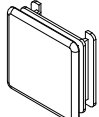
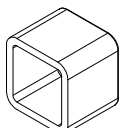
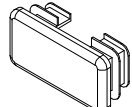
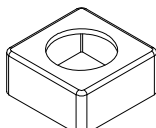

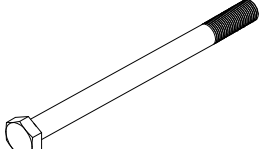
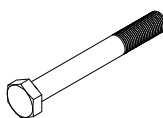
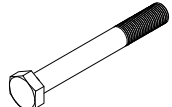
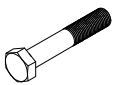
 32 Pulley(3.5") x 12PCS

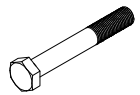
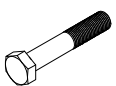
FIXINGS

IF YOU SUSPECT YOU MAY HAVE SOME PARTS MISSING, PLEASE CONTACT US BEFORE GOING BACK TO YOUR RETAILER. REFER TO THE CUSTOMER SUPPORT SECTION FOR CONTACT DETAILS.

 <p>13 Pulley H x 1PC</p>	 <p>14 Single Pulley Block x 2PCS</p>	 <p>15 Reverse U x 1PC</p>
 <p>16 Lat Bar x 1PC</p>	 <p>17 Foam Tube x 2PCS</p>	 <p>18 Handle Tube x 2PCS</p>
 <p>19 Tobacco-pipe x 1PC</p>	 <p>20 Pothook x 2PCS</p>	 <p>21 Weight Selector Pin x 1PC</p>
 <p>22 Rubber Ring x 2PCS</p>	 <p>26 Big Washer x 1PC</p>	 <p>27 Selector Shaft Pin x 1PC</p>
 <p>30 Leg Foam Roller x 4PCS</p>	 <p>31 Arm Foam Roller x 2PCS</p>	 <p>32 Pulley (3.5") x 12PCS (1pc pre-installed)</p>
 <p>33 Pulley Cover x 2PCS (pre-installed)</p>	 <p>34 Plum Blossom Nut x 1PC</p>	 <p>35 Upper Cable (2870mm) x 1PC</p>
 <p>36 Lower Cable (3400mm) x 1PC</p>	 <p>37 Butterfly Cable (2750mm) x 1PC</p>	 <p>38 Oil Bushing (Small) x 2PCS (pre-installed)</p>
 <p>39 Oil Bushing (Big) x 4PCS (pre-installed)</p>	 <p>40 Select Shaft End Cap x 1PC (pre-installed)</p>	 <p>41 M8x20mm Countersink Head Bolt x 4PCS (pre-installed)</p>

FIXINGS

 42 Chain x 1PC	 43 Bumper x 1PC (pre-installed)	 44 Select Shaft Bushing x 1PC
 45 25mm Round Cap x 1PC (pre-installed)	 46 Handle Grip x 6PCS (4pcs pre-installed)	 47 38mm Square End Cap x 8PCS (pre-installed)
 48 45mm Square End Cap x 2PCS (pre-installed)	 49 38mm Square Cap x 3PCS (pre-installed)	 50 20x40mm Square End Cap x 2PCS (pre-installed)
 51 ø38xø26 Middle-empty Cap x 2PCS	 52 25mm Round End Cap x 4PCS (pre-installed)	
 54 M12x120mm Hex Bolt x 1PC	 55 M10x20mm Hex Bolt x 2PCS	 56 M10x60mm Hex Bolt x 11PCS
 57 M10x45mm Hex Bolt x 11PCS (1pc pre-installed)	 58 M8x20mm Hex Bolt x 2PCS (pre-installed)	 59 M8x50mm Hex Bolt x 2PCS
 60 M8x40mm Hex Bolt x 2PCS	 61 M8x25mm Hex Bolt x 1PC	 62 M8x15mm Hex Bolt x 4PCS
 63 M12 Washer x 4PCS (2pcs pre-installed)	 64 M10 Washer x 50PCS (2pcs pre-installed)	 65 M8 Washer x 14PCS (2pcs pre-installed)
 66 M12 Nylock Nut x 3PCS (2pcs pre-installed)	 67 M10 Nylock Nut x 24PCS (1pc pre-installed)	 68 M8 Nylock Nut x 3PCS

PARTS

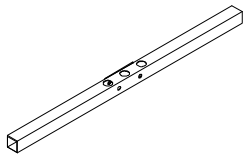

1 Rear Base Frame x 1PC

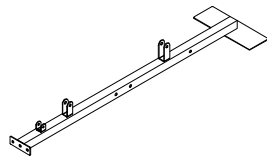

2 Front Base Frame x 1PC

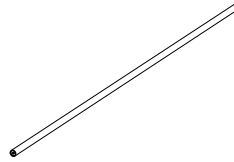

3 Weight Guide Tube x 2PCS

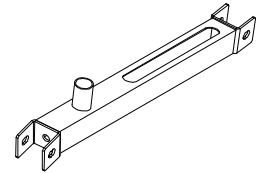

4 Front Support Frame x 1PC

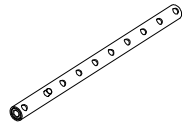

5 Selector Shaft x 1PC

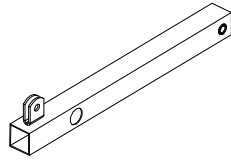

6 Leg Extension Frame x 1PC

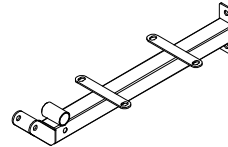

7 Seat Base Frame x 1PC

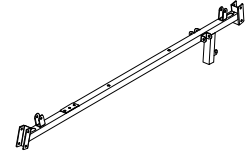

8 Support Frame x 1PC

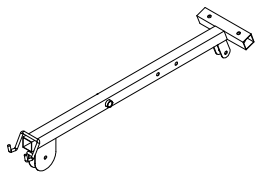

9 Upper Cross Beam x 1PC

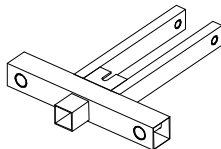

10 Press Bar x 1PC

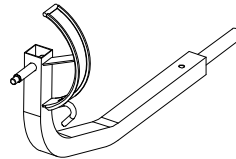

11 Left Butterfly Arm x 1PC

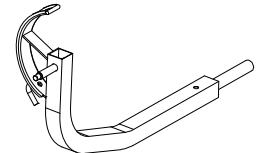

12 Right Butterfly Arm x 1PC

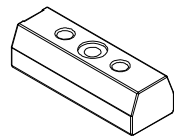

23 Top Weight Plate x 1PC

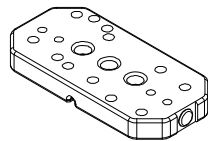

24 Weight Plate (10LB) x 9PCS

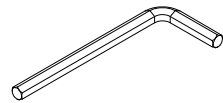

25 Wrench x 1PC

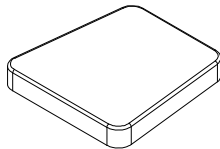

28 Seat Cushion x 1PC

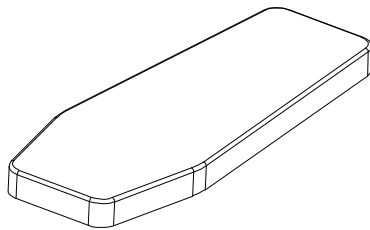

29 Back Cushion x 1PC

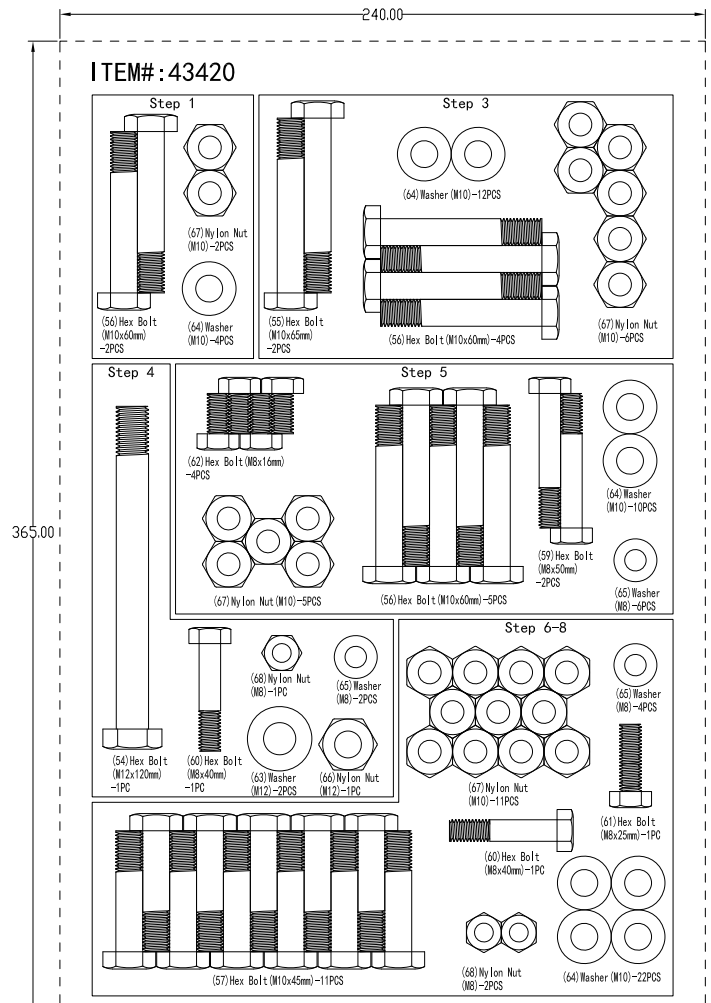

WARNING: VERY IMPORTANT INFORMATION

IT IS VERY IMPORTANT TO ENSURE THAT THERE ARE ENOUGH THREADS ENGAGED INTO THE TOP OF THE SELECTOR STEM

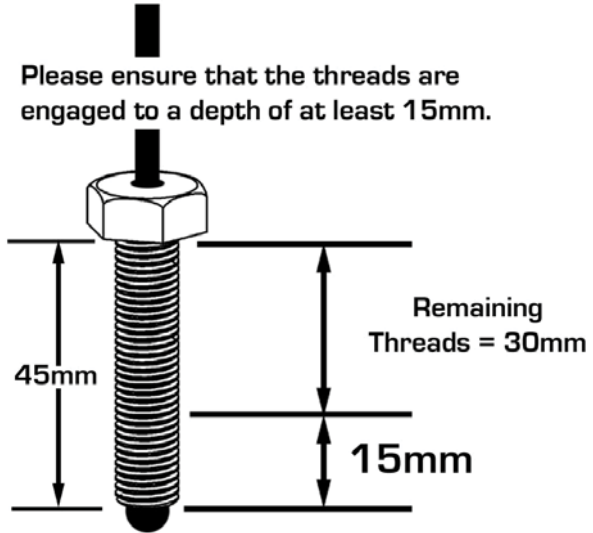
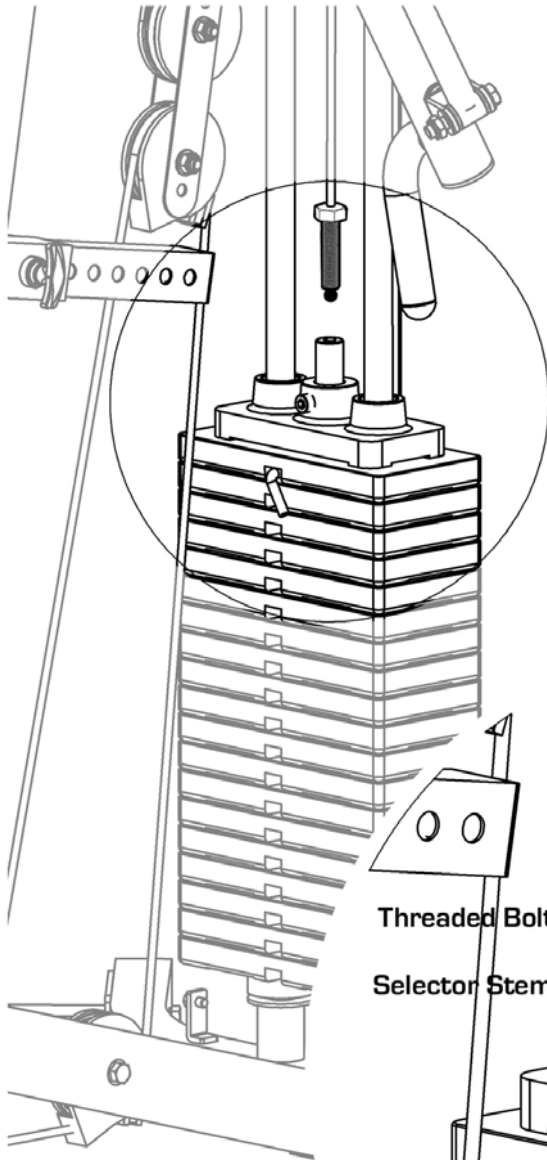

E.g. If total bolt length is 45mm, then remaining thread measurement should be 30mm

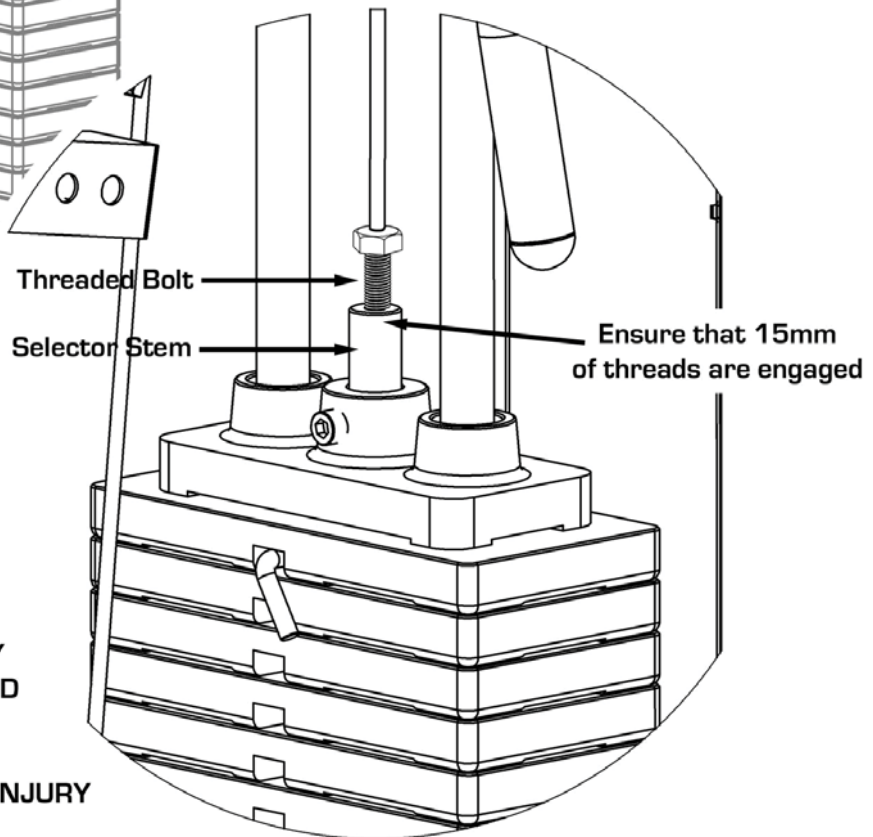

WARNING

IF BOLT IS NOT ENGAGED AS DESCRIBED, THE THREADS MAY FAIL RESULTING IN UNEXPECTED SUDDEN HEAVY WEIGHT SHIFT.

THIS COULD LEAD TO SERIOUS INJURY

Ensure that the threads are engaged accordingly by measuring the length of the remaining threads.

ASSEMBLY INSTRUCTIONS

1

41 M8x20mm Countersink Head Bolt x 2PCS (pre-installed) 

56 M10x60mm Hex Bolt x 2PCS 

64 M10 Washer x 4PCS 

67 M10 Nylock Nut x 2PCS 

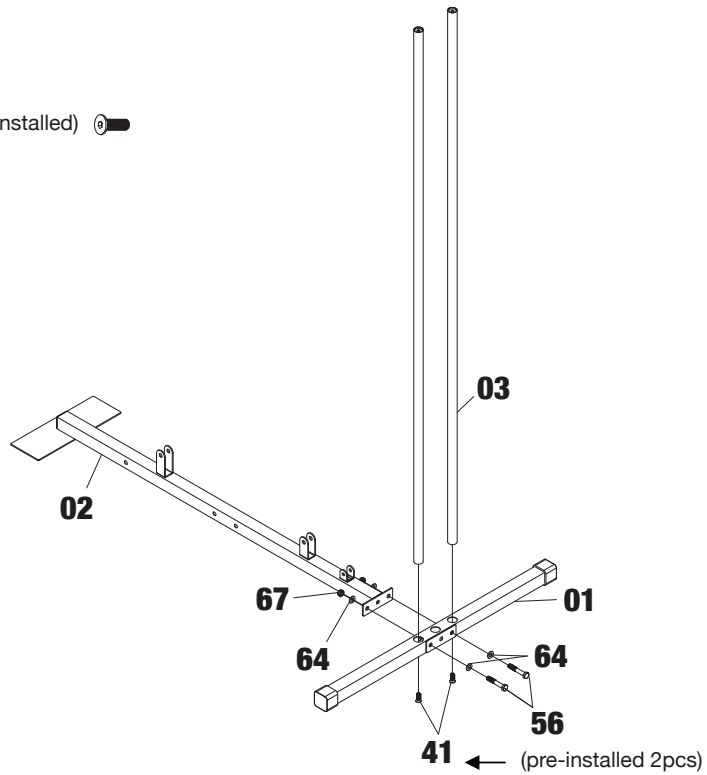

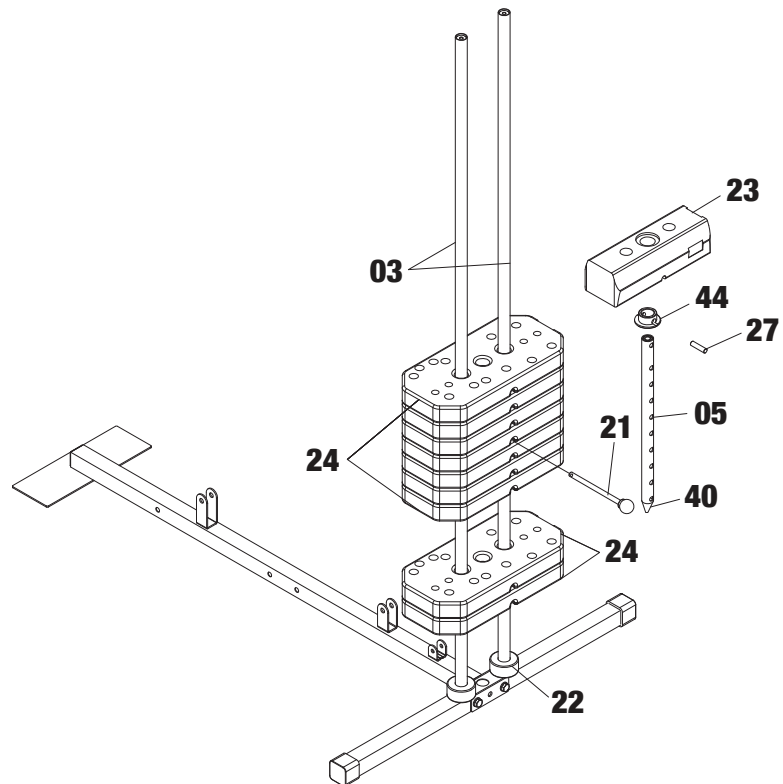

2



ASSEMBLY INSTRUCTIONS

3

41 M8x20mm Countersink Head Bolt x 2PCS (pre-installed) 

55 M10x65mm Hex Bolt x 2PCS 

56 M10x60mm Hex Bolt x 4PCS 





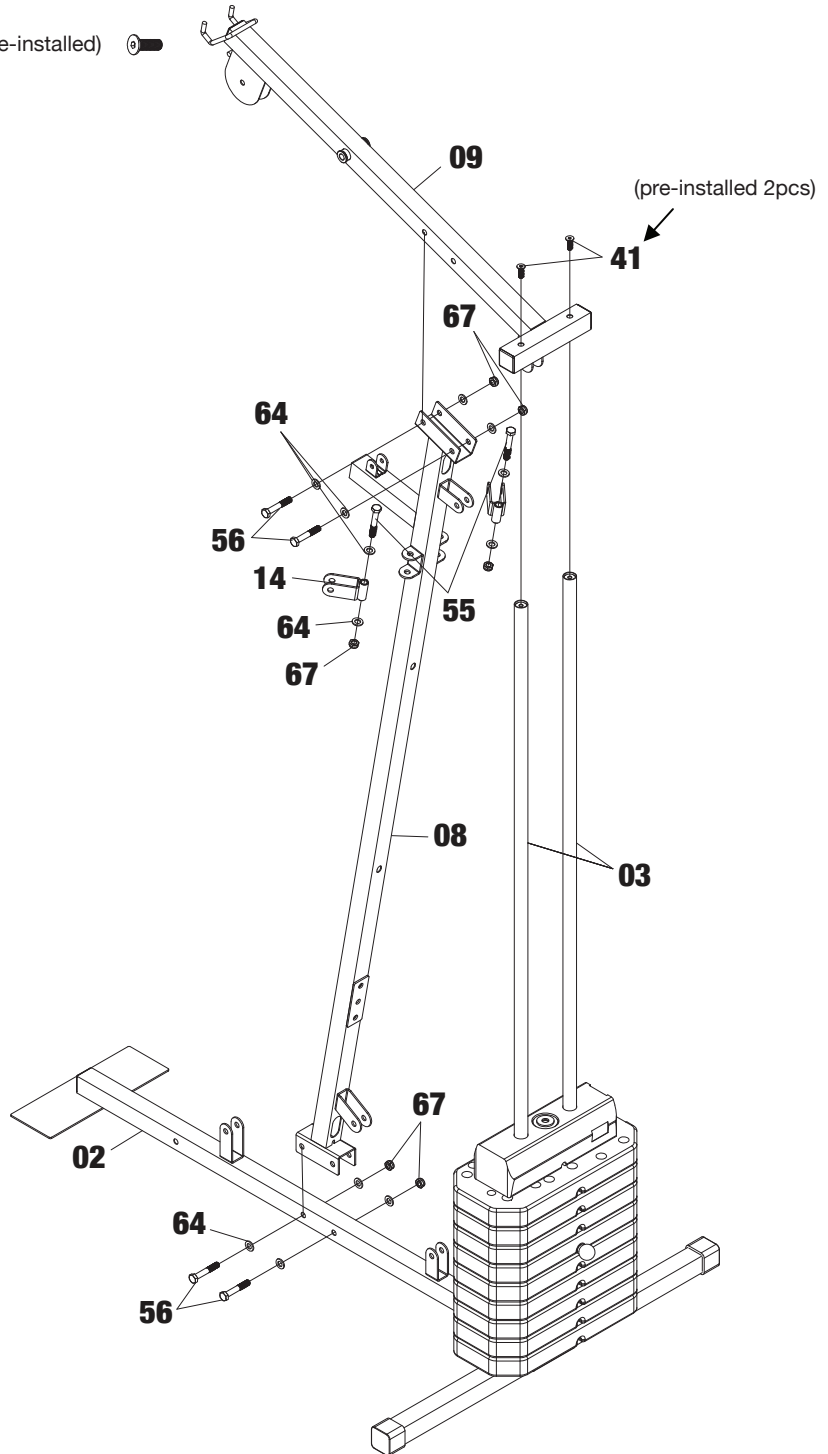

64 M10 Washer x 12PCS 

67 M10 Nylock Nut x 6PCS 



ASSEMBLY INSTRUCTIONS

4

- 54 M12x120mm Hex Bolt x 1PC 
- 58 M8x20mm Hex Bolt x 2PCS (pre-installed) 
- 60 M8x40mm Hex Bolt x 1PC 
- 63 M12 Washer x 4PCS (pre-installed 2pcs) 
- 65 M8 Washer x 4PCS (pre-installed 2pcs) 
- 66 M12 Nylock Nut x 3PCS (pre-installed 2pcs) 
- 68 M8 Nylock Nut x 1PC 

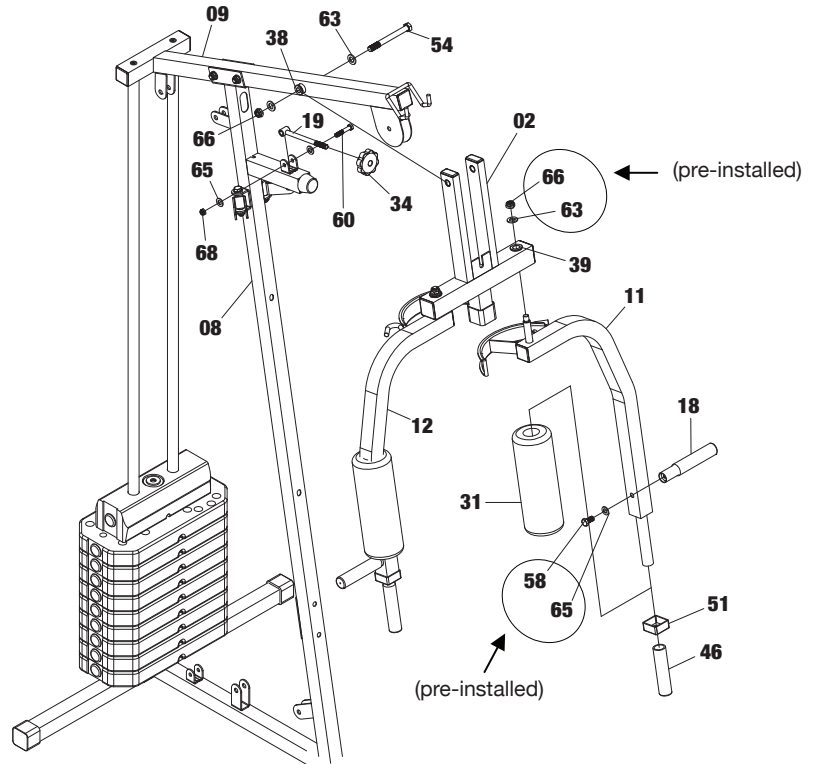



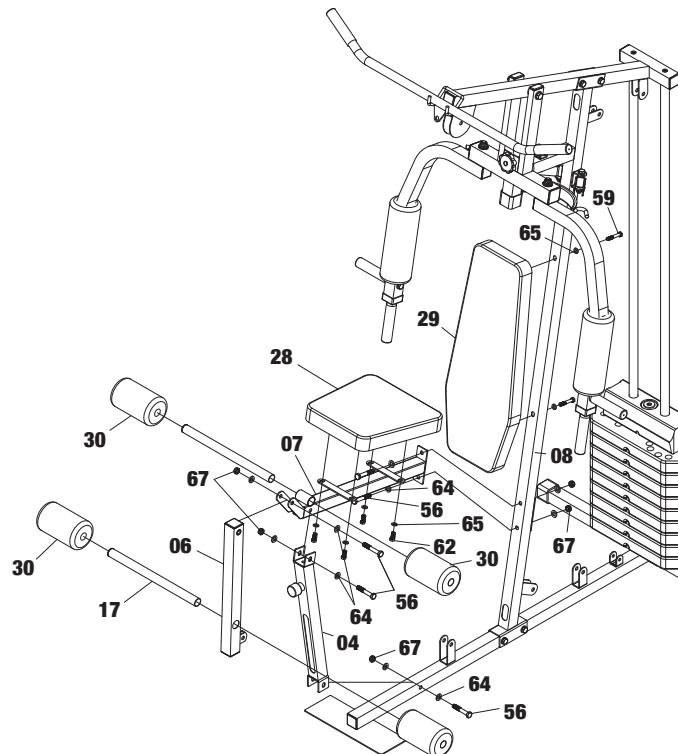

5

- 56 M10x60mm Hex Bolt x 5PCS 
- 59 M8x50mm Hex Bolt x 2PCS 
- 62 M8x16mm Hex Bolt x 4PCS 
- 64 M10 Washer x 10PCS 
- 65 M8 Washer x 6PCS 
- 67 M10 Nylock Nut x 5PCS 

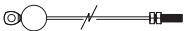

ASSEMBLY INSTRUCTIONS



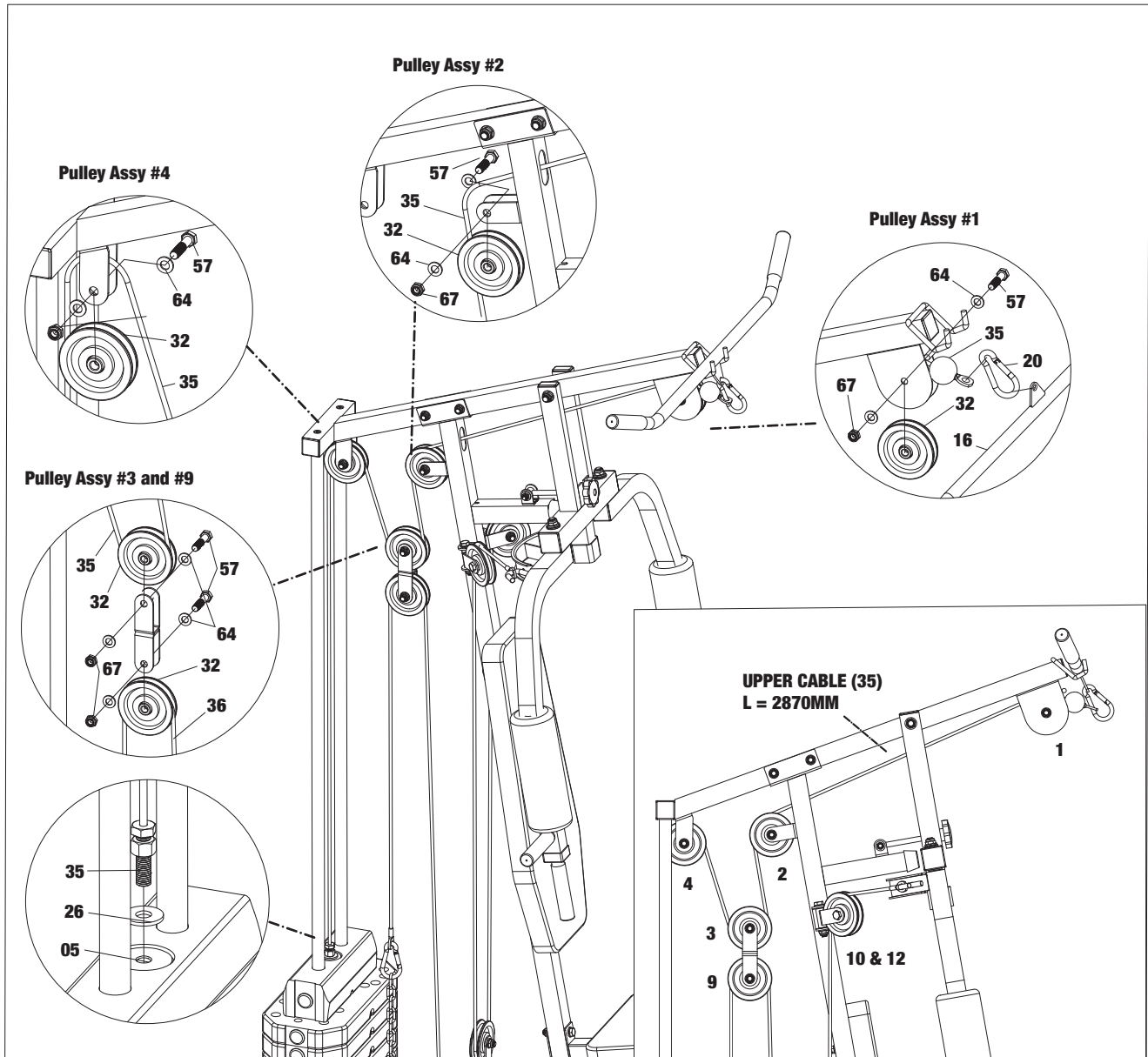

6

- 32 Pulley (3.5") x 4PCS 
- 35 Upper Cable (2870mm) x 1PC 
- 64 M10 Washer x 8PCS 
- 57 M10x45mm Hex Bolt x 4PCS 
- 67 M10 Nylock Nut x 4PCS 

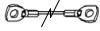

ASSEMBLY INSTRUCTIONS





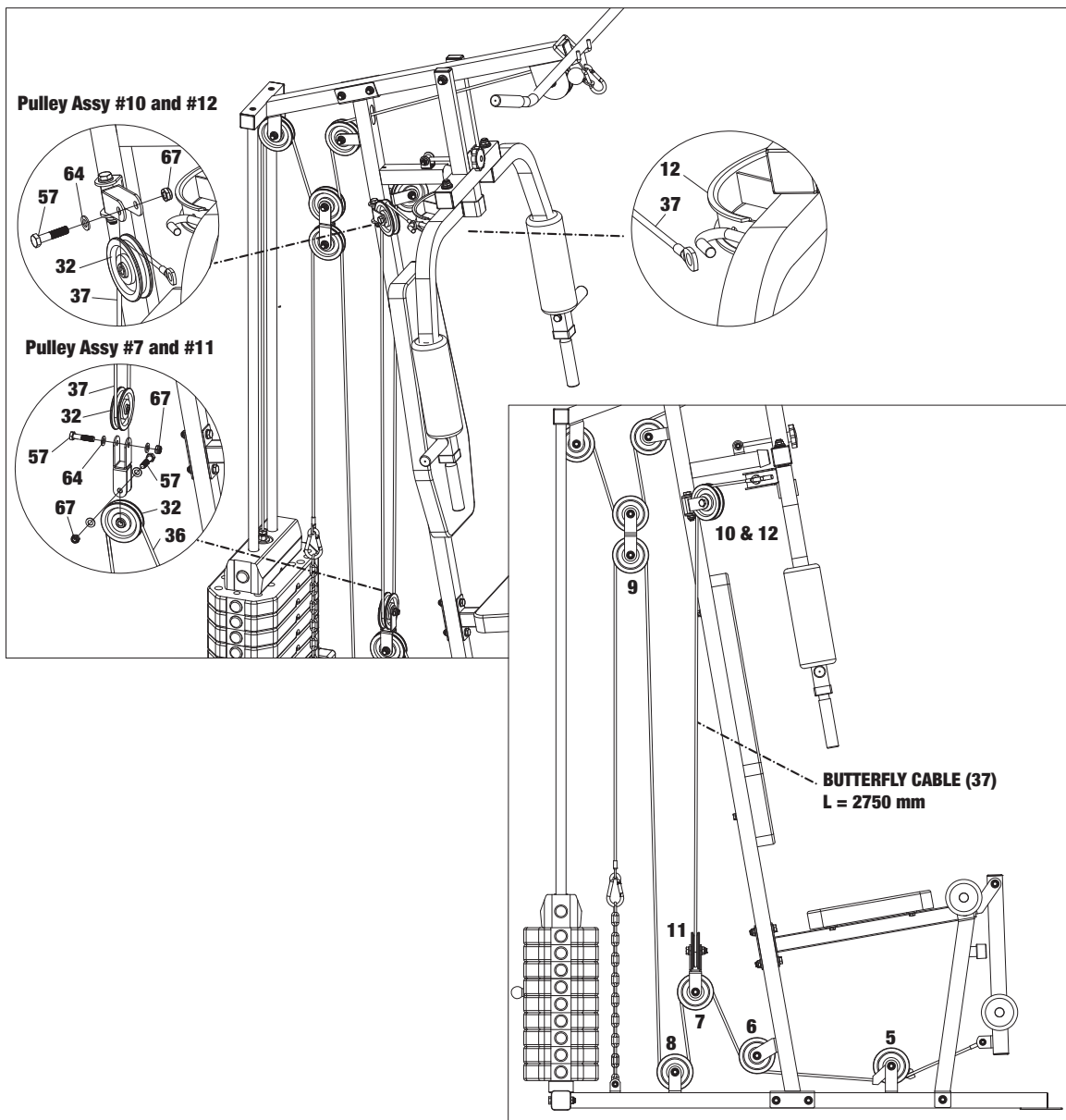





7

- 32 Pulley (3.5") x 3PCS 
- 37 Butterfly Cable (2750mm) x 1PC 
- 57 M10x45mm Hex Bolt x 3PCS 
- 64 M10 Washer x 6PCS 
- 67 M10 Nylock Nut x 3PCS 



ASSEMBLY INSTRUCTIONS

8

- 32 Pulley (3.5") x 5PCS (1pc pre-installed) 
- 33 Pulley Cover x 2PCS (pre-installed) 
- 36 Lower Cable (3400mm) x 1PC 
- 57 M10x45mm Hex Bolt x 5PCS (1pc pre-installed) 
- 60 M8x40mm Hex Bolt x 1PC 
- 61 M8x25mm Hex Bolt x 1PC 
- 64 M10 Washer x 10PCS (2pcs pre-installed) 
- 65 M8 Washer x 4PCS 
- 67 M10 Nylock Nut x 5PCS (1pc pre-installed) 
- 68 M8 Nylock Nut x 2PCS 

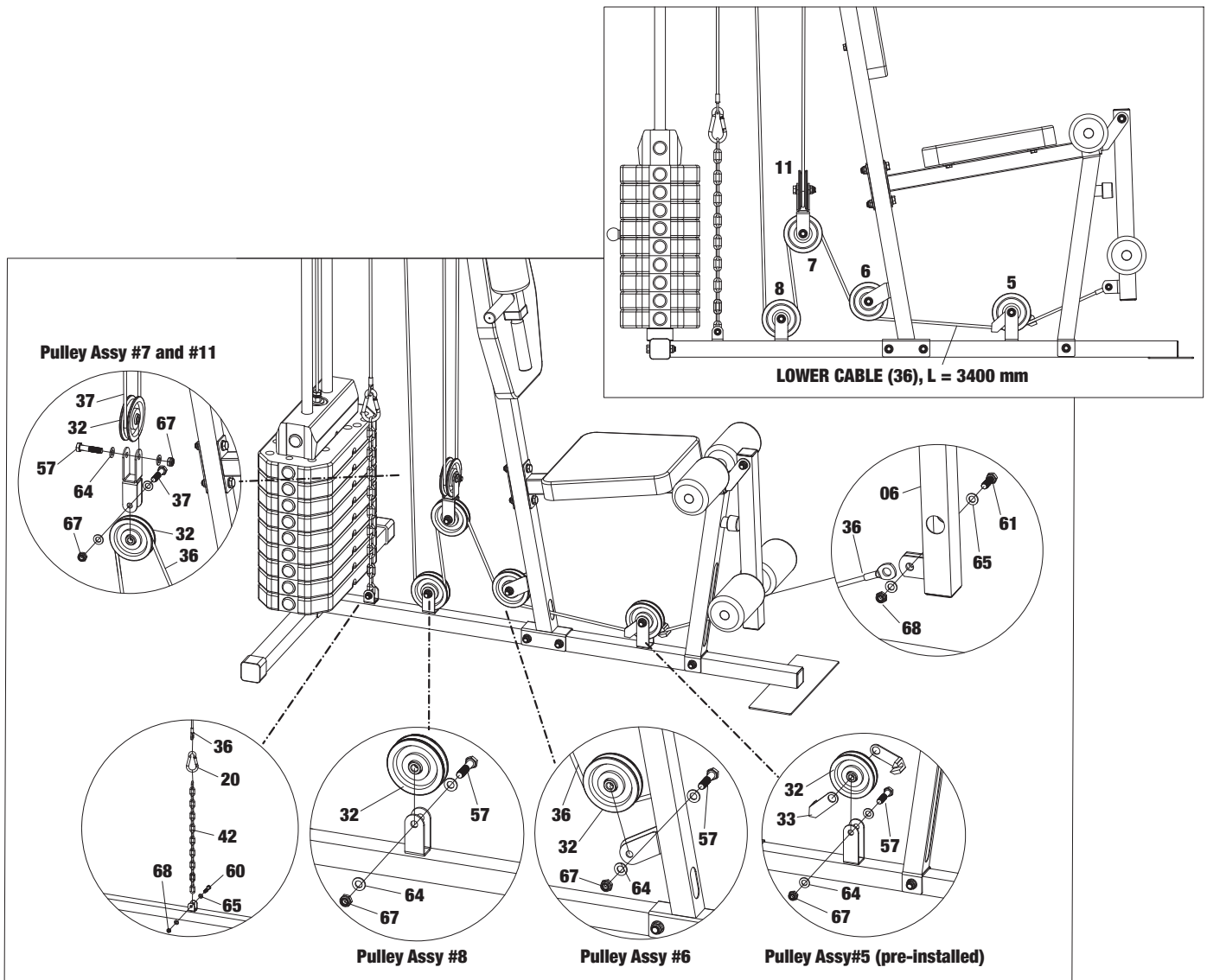

YORK[®]
ASPIRE 420

