



ASSEMBLY INSTRUCTIONS

NETBALL SYSTEM

MODEL 1111

BEFORE ASSEMBLY:

- Decide with what to fill the base (sand is recommended).
- At least 2 adults required to complete assembly



WATCH 3D ANIMATION OF THE FULL ASSEMBLY

BILT. Download on the App Store GET IT ON Google Play

OR WATCH THE HOW-TO ON YOUTUBE

SCAN THE CODE OR SEARCH 1025492

Scan the code, or visit go.lifetime.com/lifetimenetball

YouTube® and the YouTube logo are trademarks of Google, LLC.

IMPORTANT, RETAIN FOR FUTURE REFERENCE: READ CAREFULLY.

Save this instruction in the event that the manufacturer has to be contacted for replacement parts.

TOOLS REQUIRED

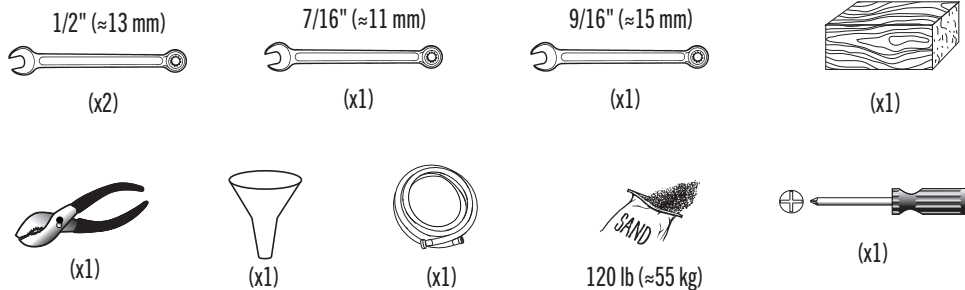

TABLE OF CONTENTS

Icon Legend.....	2
Warnings & Notices.....	3
Pole Assembly.....	4
Pole-to-Base Assembly.....	9
Parts Identifier.....	i-iv
Final Assembly.....	15
Height Adjustment.....	19
Moving the System.....	19
Maintenance.....	19
Warning Sticker.....	20
Registration.....	21
Warranty.....	22

QUESTIONS?

CONTACT LIFETIME CUSTOMER SERVICE:

Dial **1-800-225-3865**
 7:00 am–5:00 pm (M–F) MST
 and 9:00 am–1:00 pm (Sat) MST

Live Chat:
www.lifetime.com/customerservice
 (Click on the "LIVE CHAT" tab)

For Customer Service in Mainland
 Europe and the United Kingdom,
 E-mail: cs@lifetimeproducts.eu

Model Number: 1111
 Product ID:



ICON LEGEND



- Indicates special heed should be taken when reading.



- Indicates the parts to be used for a section.



- Indicates no parts required for a specific section.



- Indicates the hardware to be used for a section.



- Indicates no hardware required for a specific page.



- Indicates the tools to be used for a section.



- Indicates to use an electric drill for a specific step.



- Indicates not to use an electric drill for a specific step.



- These nuts are centerlock nuts. They are designed to be tight; therefore, they will be harder to tighten. Tighten until flush with the metal or plastic.



- Indicates the number of adults required for a specific step, i.e., 2, 3, 4, etc.



WARNINGS & NOTICES



SAFETY INSTRUCTIONS



FAILURE TO FOLLOW THESE WARNINGS MAY RESULT IN SERIOUS INJURY OR PROPERTY DAMAGE AND WILL VOID WARRANTY.

Owner must ensure that all players know and follow these rules for safe operation of the system.

To ensure safety, do not attempt to assemble this product without following the instructions carefully. Check entire box and inside all packing material for parts and/or additional instruction material. Before beginning assembly, read the instructions and identify parts using the hardware identifier and parts list in this document. Proper and complete assembly, use and supervision are essential for proper operation and to reduce the risk of accident or injury. A high probability of serious injury exists if this product is not installed, maintained, and operated properly.

- If using a ladder during assembly, use extreme caution.
- Two capable adults are recommended for this operation.
- Check base daily for leakage. Leaks will cause system to fall.
- Assemble the pole sections properly. Failure to do so could cause the pole sections to separate during play or transport.
- Minimum operational height is 244 cm (8 ft) to the bottom of the rim.

Most injuries are caused by misuse and/or not following instructions. Use caution when using this product.

1

POLE ASSEMBLY



HARDWARE REQUIRED

Hardware Bag

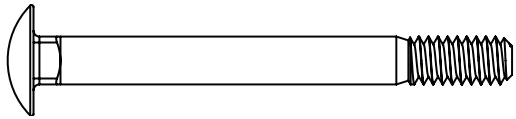

ACL (x1)

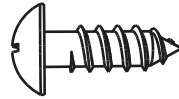

ADS (x3)

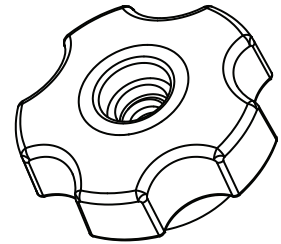

ACN (x1)



PARTS REQUIRED

Metal Parts



ALH (x1)



ALP (x1)



ALO (x1)



ALE (x1)

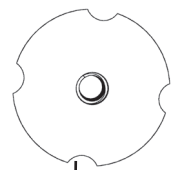

TOOLS REQUIRED



(x1)



Wood Block

SECTION 1 (CONTINUED)

TOOLS AND HARDWARE REQUIRED



- If you have trouble with this section, scan the QR code below to view the assembly video.

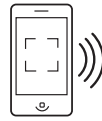

<http://go.lifetime.com/lifetimenetballsec1>



POLE SECTION IDENTIFICATION

- Identify the pole sections before beginning assembly. Failure to assemble the pole sections correctly may result in severe personal injury or property damage as described on page two.

*******ONCE THE POLE SECTIONS HAVE BEEN SEATED, THEY CANNOT BE SEPARATED*******



ALH

Top Pole (ALH):
Ten holes along the front and back, four holes towards the top sides and one hole at the bottom.



ALP

Upper Middle Pole (ALP):
Two holes opposite each other at the top and two holes towards the bottom.



ALO

Lower Middle Pole (ALO):
One slot at the top of the pole and one hole near the bottom end.



ALE

Bottom Pole (ALE):
One slot at the top of the pole, two holes in the middle and one nut inside the bottom end.

SECTION 1 (CONTINUED)

TOOLS AND HARDWARE REQUIRED

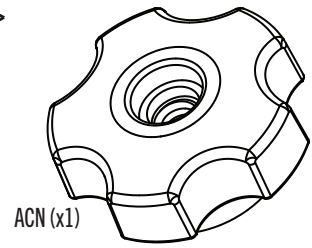
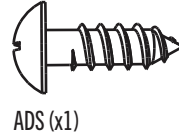
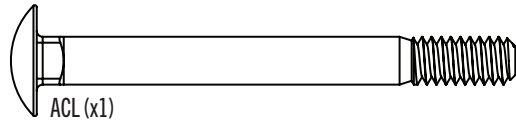

1.1

- Pull the plastic off the **top pole (ALH)**. It may be necessary to loosen the poles before pulling out the plastic.

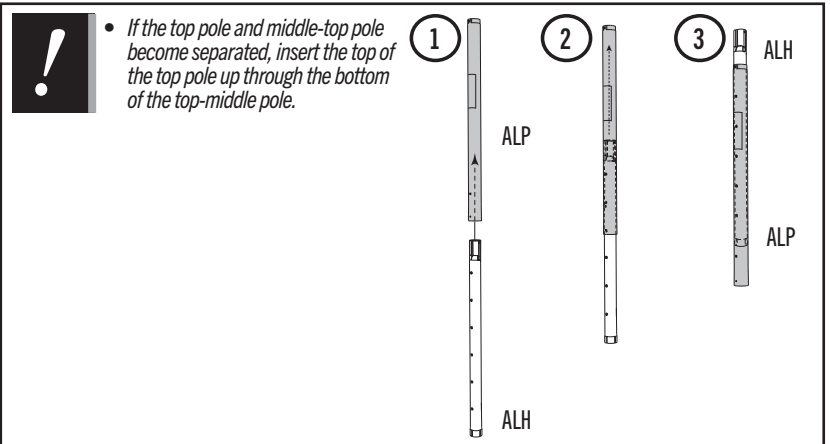
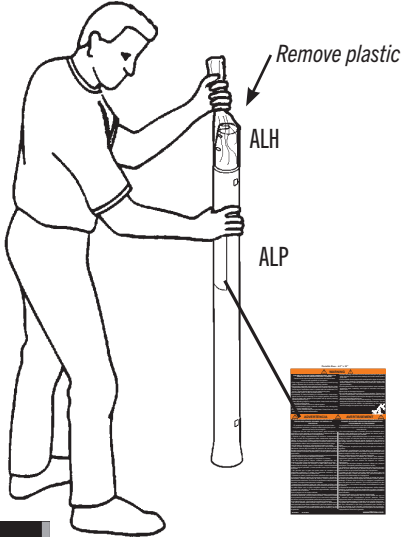

1.2

- Hold the **top pole (ALH)** high enough out of the **upper middle pole (ALP)** to insert the **screw (ADS)** in the back of the middle pole.

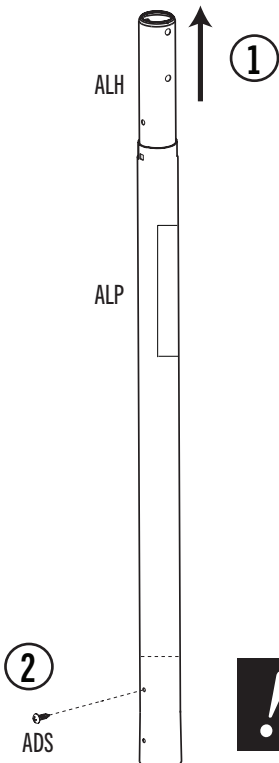

- ! The screw should be flush with the pole, but will spin freely once inserted.

1.3

- Attach the **knob (ACN)** to the upper middle pole. The knob will face the back of the system.

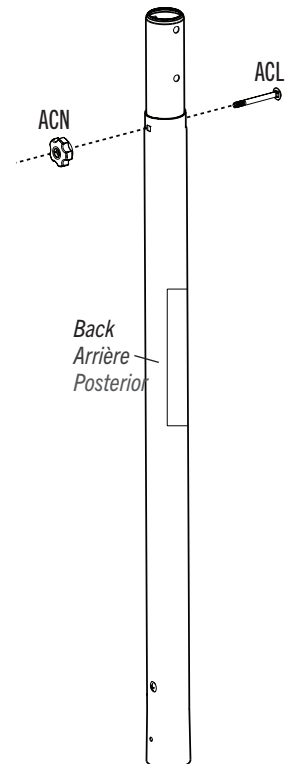

► SECTION 1 (CONTINUED)

TOOLS AND HARDWARE REQUIRED

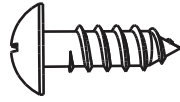

ADS (x2)

1.4

- Align the hole in the upper **middle pole (ALP)** with the slot in the **lower middle pole (ALO)** and install the hardware shown.

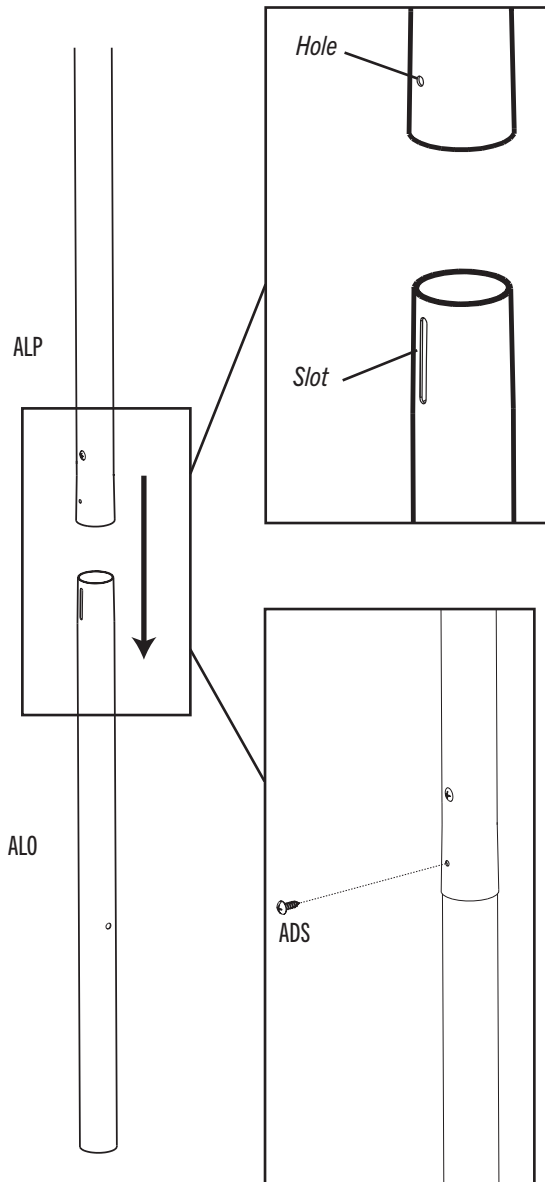

1.5

- Align the slot in the **bottom pole (ALE)** with the hole in the **lower middle pole (ALO)** and install the hardware shown.

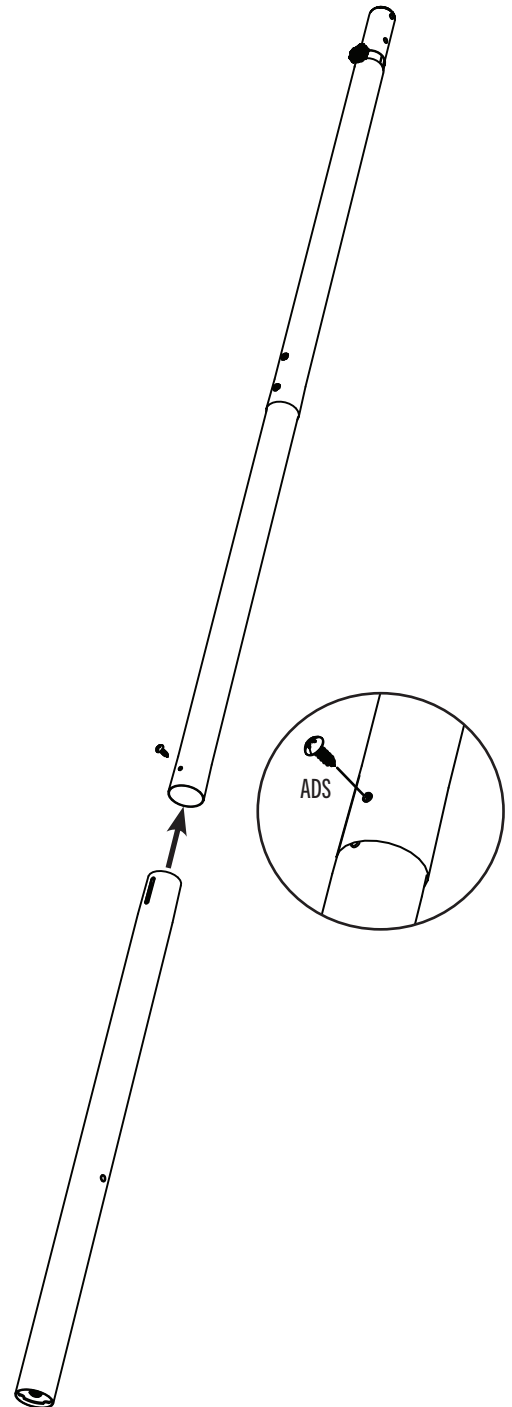

► SECTION 1 (CONTINUED)

TOOLS AND HARDWARE REQUIRED



1.6

THIS STEP CANNOT BE REVERSED!

- Strike the end of the pole assembly on a piece of scrap wood or cardboard five to six times. If the middle pole does not completely cover the slot on the bottom pole after seating, **DO NOT COMPLETE ASSEMBLY**. Call customer service.

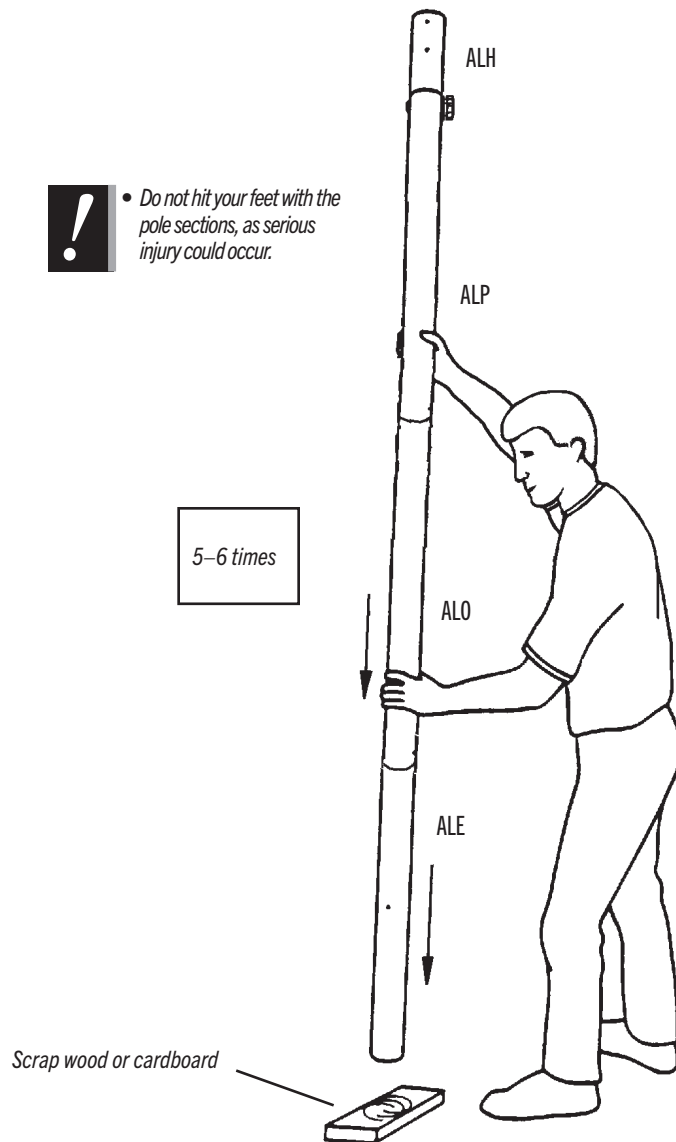

WARNING

The poles must be seated together! The poles must be struck on a hard surface five to six times! Failure to seat the poles correctly could allow the poles to separate during use.

2

POLE-TO-BASE ASSEMBLY



HARDWARE REQUIRED

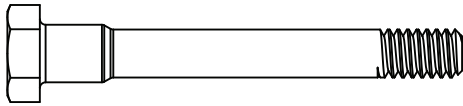

ACU (x1)

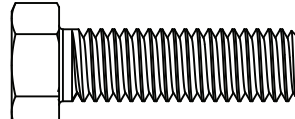

ACO (x1)

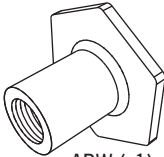

ABW (x1)

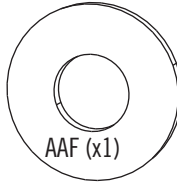

AAF (x1)

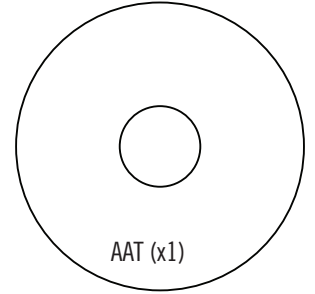

AAT (x1)



AJB (x2)

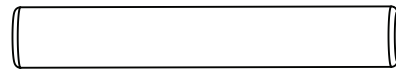

AJG (x2)



PARTS REQUIRED

Metal Part

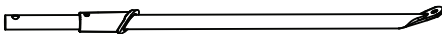

ALK (x1)

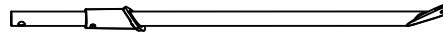

ALI (x1)

Plastic Parts

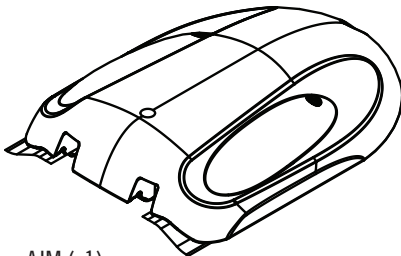

AJM (x1)

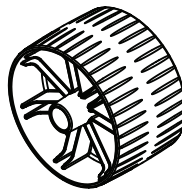

AMU (x2)



TOOLS REQUIRED

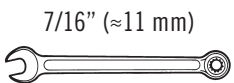

7/16" (≈11 mm)

(x1)

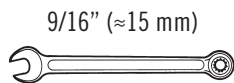

9/16" (≈15 mm)

(x1)



► SECTION 2 (CONTINUED)

TOOLS AND HARDWARE REQUIRED



AJB (x2)



- If you have trouble with this section, scan the QR code below to view the assembly video.

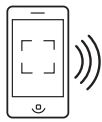

<http://go.lifetime.com/lifetimenetballsec2>

2.1

- Slide the 4" axle (AJB) into position in both wheels (AMU).

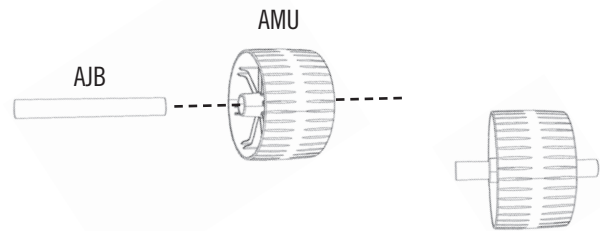

2.3

- Position the wheels as shown under the back of the base (AJM), and press the Axles into the slots indicated.

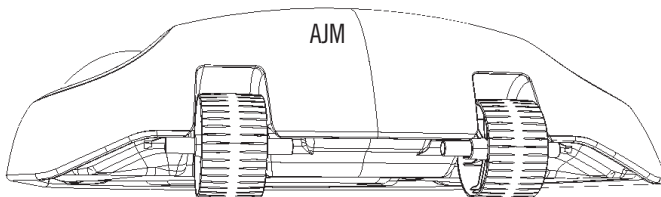

2.2

- Press down over the wheels to snap the axles in place. **Ensure both Axles are snapped securely in place.**

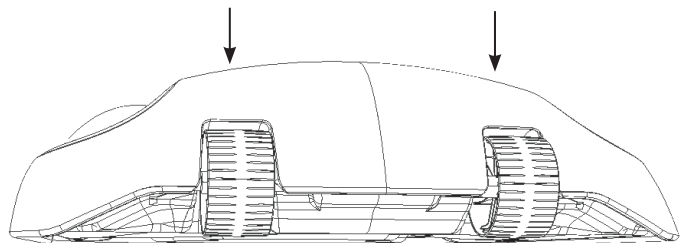

SECTION 2 (CONTINUED)

TOOLS AND HARDWARE REQUIRED



2.4

- Slide the **Right Brace (ALK)** into place through the top of the Base, with the flattened end pointing out toward the front edge as shown.

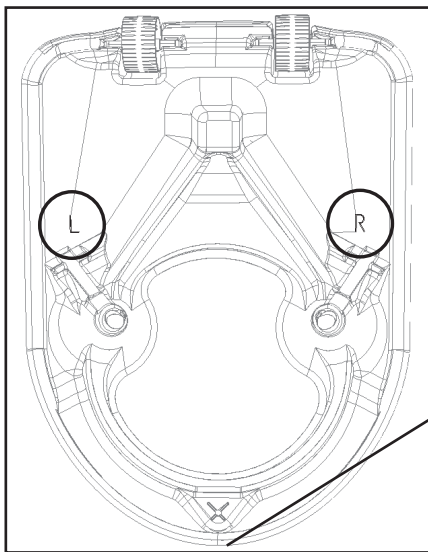

Bottom view



- *The right brace is marked with a letter "R" sticker.*

Front edge



ALK

2.5

- Repeat step 2.4 to insert the **left brace (ALI)** into the base.

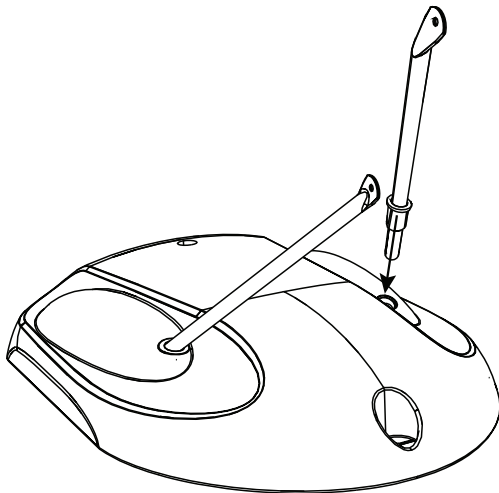

- *The left brace is marked with a letter "L" sticker.*

► SECTION 2 (CONTINUED)

TOOLS AND HARDWARE REQUIRED

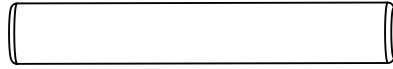

AJG (x2)

2.6

- On the underside of the base, slide the **2" axle (AJG)** into the end of the **right brace (ALK)**.

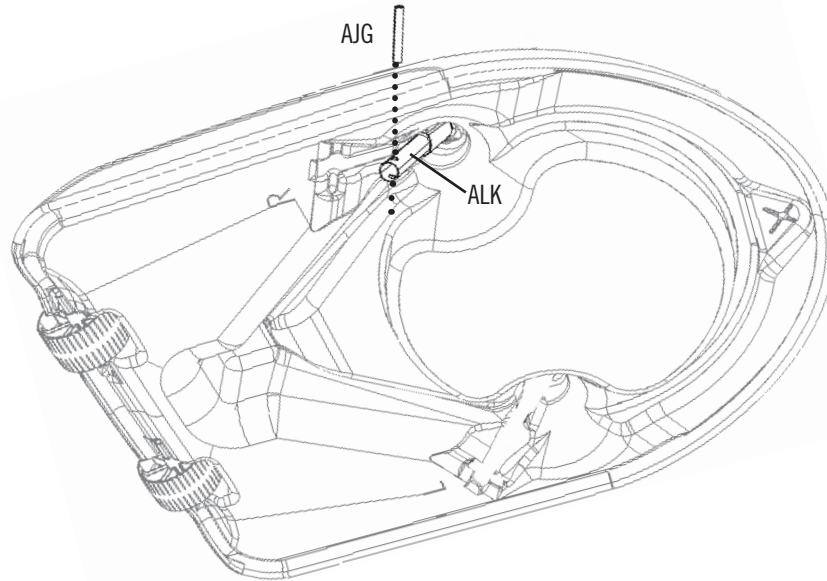

2.7

- Push pole brace forward to snap the axle in place.

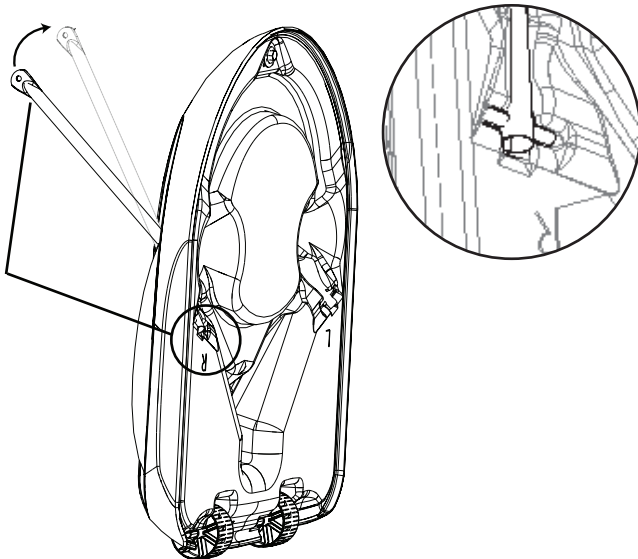

2.8

- Repeat steps 2.6–2.7 for the **left brace (ALI)**. The flat ends of the pole braces should be parallel to each other.

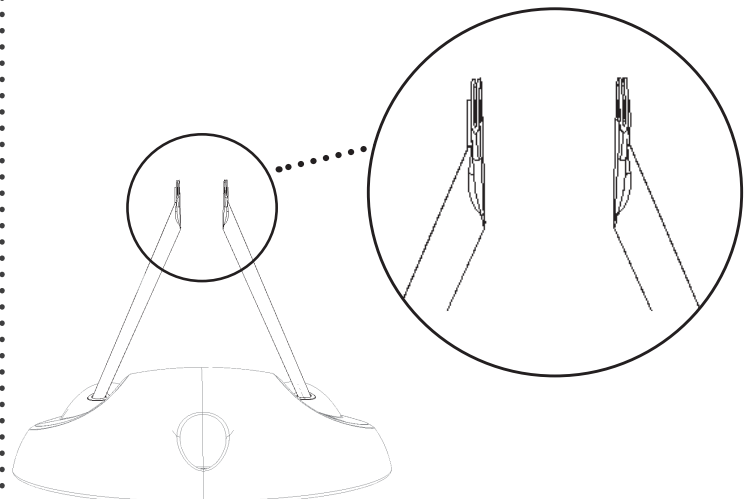

► SECTION 2 (CONTINUED)

TOOLS AND HARDWARE REQUIRED



7/16" (≈11 mm)

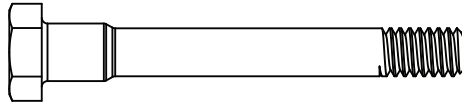

ACU (x1)

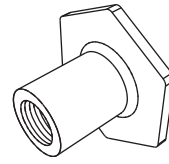

ABW (x1)

2.9

- Make sure the knob is facing toward the base. **Use pliers to hold the T-nut in place** as you secure the hardware.

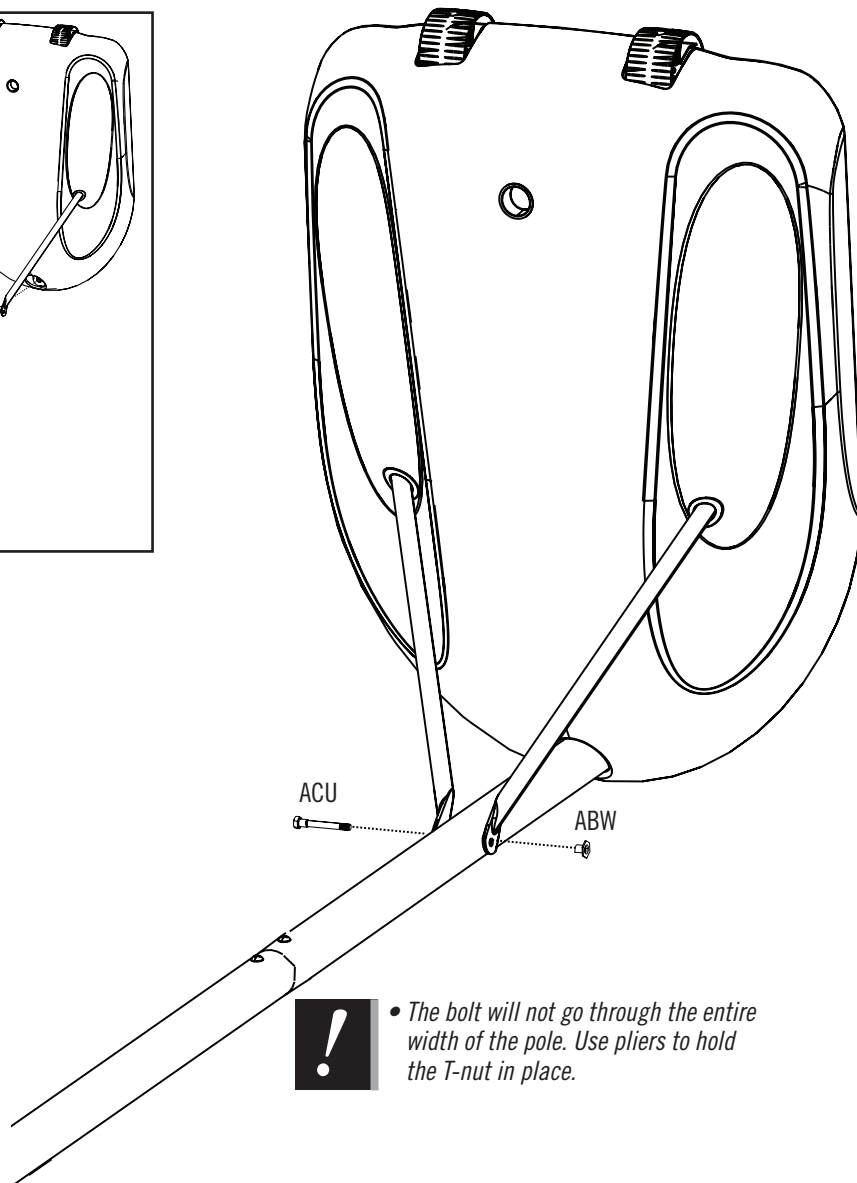
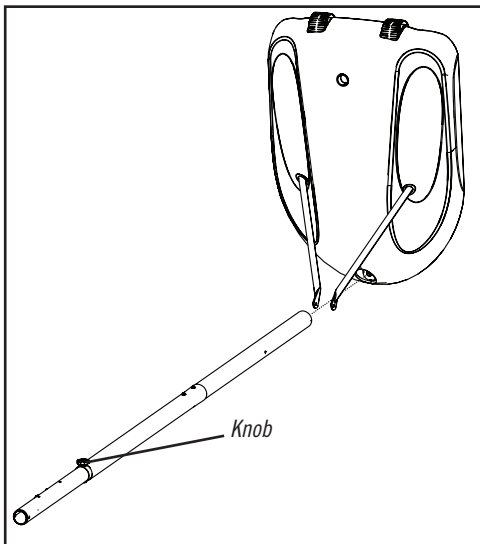

- *The bolt will not go through the entire width of the pole. Use pliers to hold the T-nut in place.*

SECTION 2 (CONTINUED)

TOOLS AND HARDWARE REQUIRED

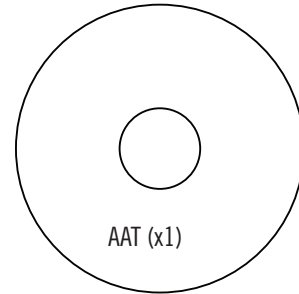
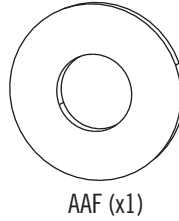
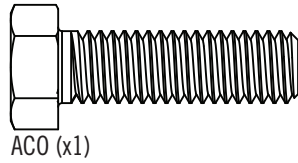
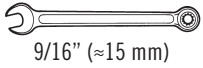

2.10

- Secure the pole assembly to the base using the hardware shown.

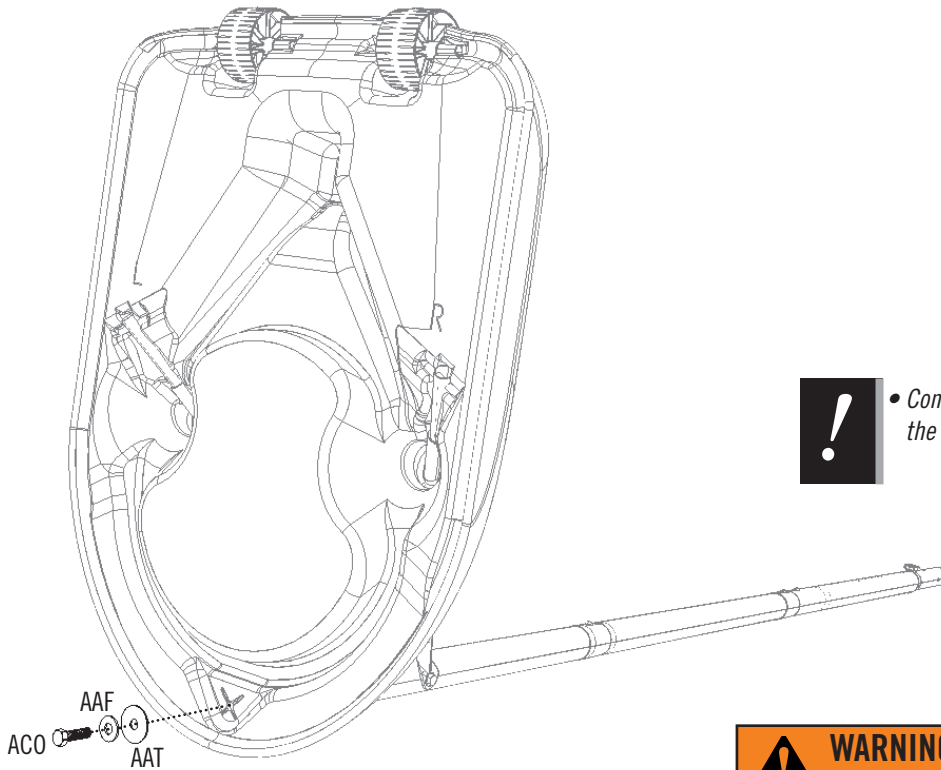

- Completely tighten the hardware.



WARNING / AVERTISSEMENT / ADVERTENCIA

Never put the system in an upright position without proper weight in the Base. The system may fall over and could result in serious personal injury or property damage.

Ne jamais mettre le système en une position verticale sans premier remplir la base avec le poids correct. Le système pourrait tomber et causer des blessures graves personnelles et/ou la mort, ou dommage à la propriété.

Nunca colocar la unidad en una posición vertical sin llenar primero la base con el peso correcto. La unidad podría caerse y ocasionar lesiones graves personales y/o la muerte, o daños a la propiedad.



This page intentionally left blank

Detach this yellow section for use as a quick reference



PARTS IDENTIFIER

Metal parts



ALH (x1)



ALP (x1)



ALO (x1)



ALE (x1)

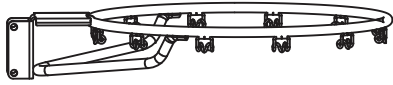
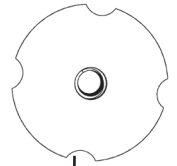

ALX (x1)



ALK (x1)



ALI (x1)

Plastic parts

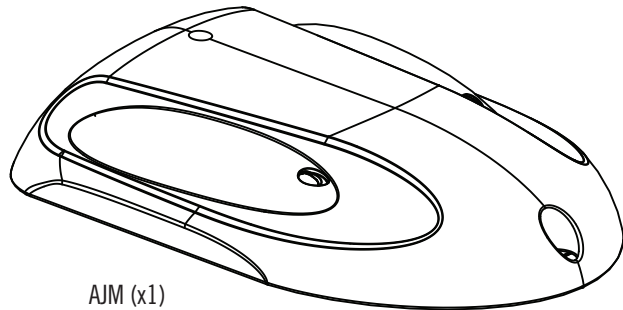

AJM (x1)

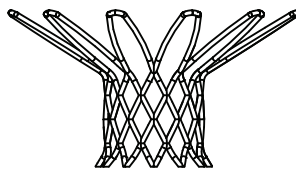

AKZ (x1)

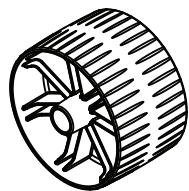

AMU (x2)

Detach this yellow section for use as a quick reference



HARDWARE REQUIRED

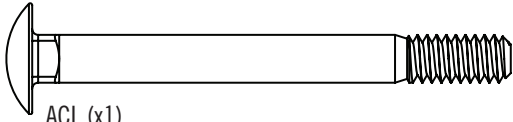

ACL (x1)

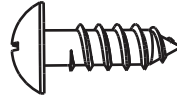

ADS (x3)

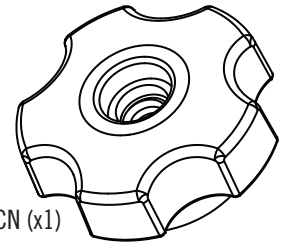

ACN (x1)

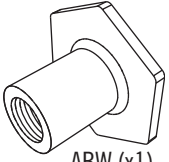

ABW (x1)

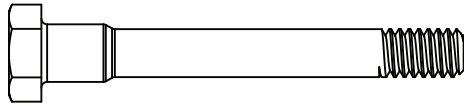

ACU (x1)



ACO (x1)

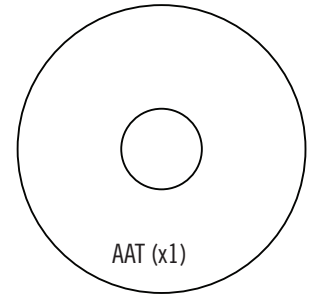

AAT (x1)

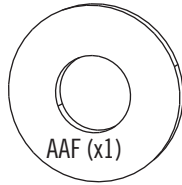

AAF (x1)



AJB (x2)



AJG (x2)

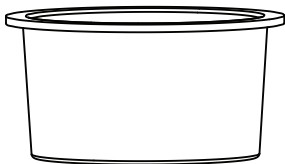

AZY (x1)

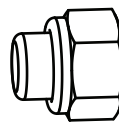

AAN (x2)

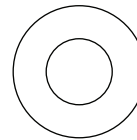

AEC (x4)

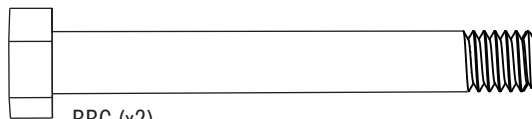

BBG (x2)

Detach this yellow section for use as a quick reference



PARTS IDENTIFIER

Detach this yellow section for use as a quick reference

This page intentionally left blank

3

FINAL ASSEMBLY



HARDWARE REQUIRED

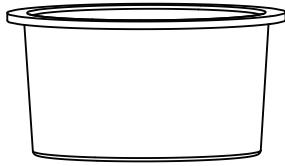

AZY (x1)

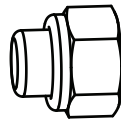

AAN (x2)

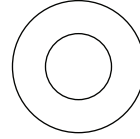

AEC (x4)

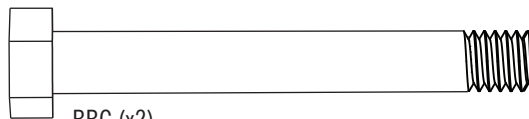

BBG (x2)



PARTS REQUIRED

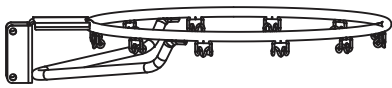

ALX (x1)

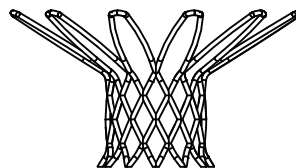

AKZ (x1)



TOOLS REQUIRED



(x1)



(x1)



120 lb (≈55 kg)

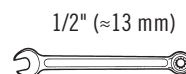

1/2" (≈13 mm)

(x2)

SECTION 3 (CONTINUED)

TOOLS AND HARDWARE REQUIRED



1/2" (≈13 mm)
(x2)

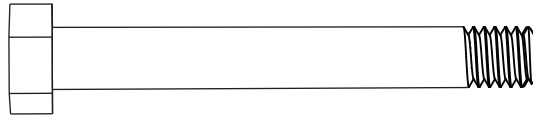

BBG (x2)

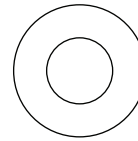

AEC (x4)

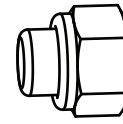

AAN (x2)



- If you have trouble with this section, scan the QR code below to view the assembly video.

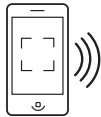

<http://go.lifetime.com/lifetimenetballsec3>

3.2

- Attach the **net (AKZ)** to the **rim (ALX)**. If a replacement net is needed, please call our Customer Service Department. Our nets are shorter than average to reduce the risk of entanglement.

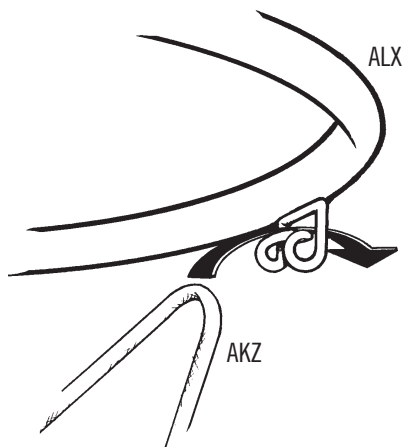

3.1



- With the assembly laying down, place the **rim (ALX)** on the top pole so it faces opposite the **adjustment knob**. Secure the rim to the pole using the hardware shown. Ensure all system hardware is secure.

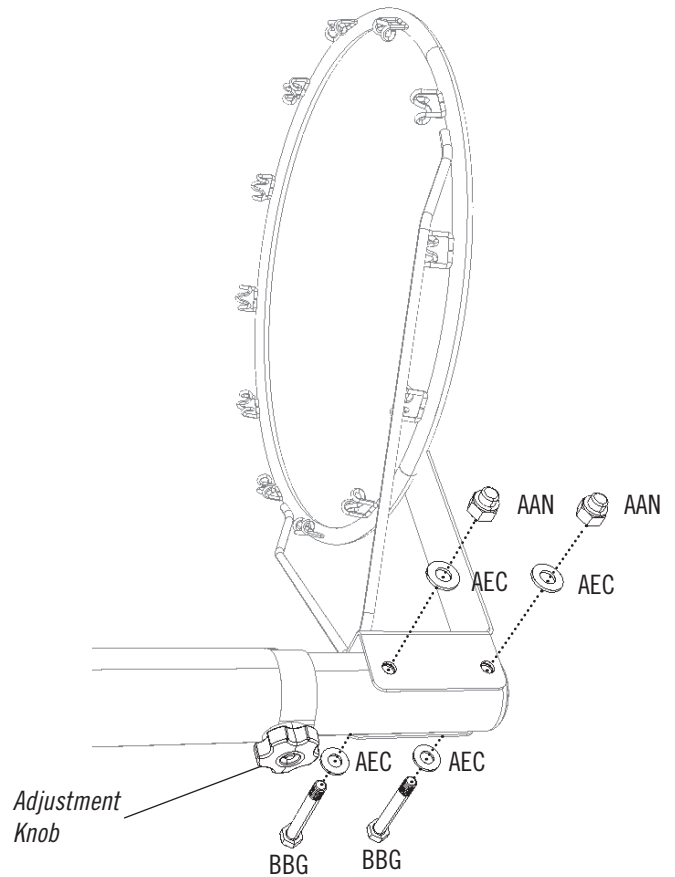

WARNING

Do not overtighten the cap nut. If the end of the bolt breaks through the plastic cap, call our Customer Service Department. Exposed threads on the end of the bolt may cause serious injuries.

▶ SECTION 3 (CONTINUED)

TOOLS AND HARDWARE REQUIRED



120 lb
(≈55kg)

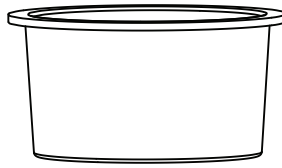

AZY (x1)

3.3a

OPTION A: FILLING THE BASE WITH SAND



- While one adult holds the pole, use a funnel to add sand through the hole in the top of the base until it is just below the hole (**Fig. 1**). With the help of a second adult, carefully pull the system up until it is almost upright. Finish filling the base with sand (**Fig. 2**). Insert the **base plug (AZY)** into the fill hole.



Fig. 1



Fig. 2

⚠ WARNING ⚠

For safety reasons, we recommend that sand be used instead of water to fill the Base. If a leak develops, water could run out unnoticed, allowing the system to fall over, resulting in serious personal injuries or property damage. If using Water, check the Base carefully for leaks. If a leak is found, lay the system down on the ground and call Customer Service. Do not use, stand up, or play on a leaking system.

▶ SECTION 3 (CONTINUED)

TOOLS AND HARDWARE REQUIRED

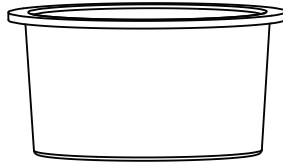

AZY (x1)

3.3b

OPTION B: FILLING THE BASE WITH WATER

- While one adult holds the pole, add water through the hole in the top of the base until it is just below the hole (**Fig. 1**). Add one tablespoon of chlorine bleach to the water in the base. Using two adults, carefully pull the system up until it is almost upright. Finish filling the base with water (**Fig. 2**). Insert the **base plug (AZY)** into the fill hole.



Fig. 1



Fig. 2

WARNING

For safety reasons, we recommend that sand be used instead of water to fill the Base. If a leak develops, water could run out unnoticed, allowing the system to fall over, resulting in serious personal injuries or property damage. If using Water, check the Base carefully for leaks. If a leak is found, lay the system down on the ground and call Customer Service. Do not use, stand up, or play on a leaking system.



When Using Water

1. Make sure the surface beneath the base is smooth and free of stones, gravel, or sharp objects that could puncture the base and cause leakage.
2. Check the base frequently for cracks or punctures.
3. Always check the water level before play.
4. If the system is to be stored without weight in the base, tilt it forward and rest the rim on the ground.
5. Every time the base is filled with water, add one tablespoon of chlorine bleach to the water to prevent algae formation in the base.



HEIGHT ADJUSTMENT

The basketball system may be adjusted from 5 1/2 feet (1.68 m) to 7.5 feet (2.3 m).

ONLY ADULTS SHOULD ADJUST THE HEIGHT OF THE SYSTEM.

- Stand behind the system and pull on the pole until the backboard rests on the ground.
- Remove the adjustment knob and the carriage bolt. Adjust the system to the desired height and replace the bolt and knob.
- Make sure the adjustment knob is secure before standing the system back up to playing position

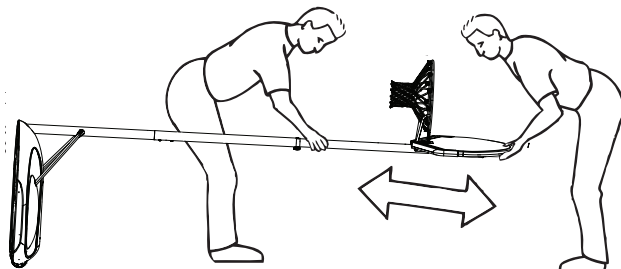

MOVING THE SYSTEM



WARNING: The system must only be moved by people capable of handling its weight. Children should not be allowed to move the system.

- Adjust the system to its lowest position, and use caution to prevent the height mechanism from adjusting.
- Stand behind the system and pull on the pole until the unit is balanced on its wheels.
- Move the system to the desired location and carefully set the base down.



CAUTION: The system must only be moved on its wheels. Sliding the base may damage the base which could result in leakage and the system tipping over.



MAINTENANCE

The life of your basketball system depends on many variables. The climate, exposure to corrosives such as salt, pesticides, or herbicides, and excessive use or misuse can all contribute to Pole failure, which may cause property damage or personal injury.

Check your basketball system frequently for loose hardware, excessive wear, and signs of corrosion. For safety reasons, and to prolong the life of your basketball system, you must take the following preventive measures.

- Check all Nuts and Bolts. If any are loose, tighten them.
- Check all parts for excessive wear and tear. If necessary, replace any parts that have been worn or damaged through usage. Contact our Customer Service Department for replacement parts.
- Inspect the Warning Sticker on the Pole. If it is ripped, faded, or illegible, call our Customer Service Department to request a replacement Sticker.
- Check all Pole sections for visible rust or chipped or cracked paint. If either are present, do the following:
 - Use an emery cloth to completely remove any rust or chipped paint.
 - Clean the area with a damp cloth and allow it to dry.
 - Apply two coats of a rust preventative, high gloss enamel paint to the area. Allow the paint to dry between coats.

IF RUST HAS PENETRATED THROUGH THE POLE ANYWHERE, REPLACE IT IMMEDIATELY!



WARNING STICKER / AU

WARNING

FAILURE TO FOLLOW THESE WARNINGS MAY RESULT IN SERIOUS INJURY AND/OR PROPERTY DAMAGE.

Owners must ensure that all players know and follow these rules for safe operation of the system.

- Do not hang from the rim.
- During play, especially when performing dunk type activities, keep player's face away from the backboard, rim, and net. Serious injury could occur if teeth/face come in contact with the backboard, rim, or net. Players should wear a mouth guard during play.
- Do not slide, climb, or play on base or pole.
- Completely fill base according to manufacturer's instructions. Never leave the unit standing in an upright position without first filling the base with weight or the system will tip quickly causing serious personal injury.
- When adjusting height or moving system, keep hands and fingers away from moving parts.
- Do not allow children to move or adjust system.
- Do not wear jewelry (rings, watches, necklaces, etc.) during play. Objects may entangle in net.
- Surface beneath the base must be smooth and free of gravel or other objects. Punctures cause leakage and could cause system to tip over.

- Keep water and organic material away from pole base. Grass, litter, etc. could cause corrosion and/or deterioration.
- Never play on damaged equipment.
- Once a month check pole and all metal parts for signs of corrosion (rust, pitting, chipping). Completely remove rust and repaint with exterior enamel. If rust has penetrated any steel part, replace that part immediately.
- Check system before each use for proper ballast, loose hardware, excessive wear, instability, and signs of corrosion and repair before use.
- Do not use system during windy or severe weather. System may tip over. Place system in an area protected from the wind or in an area away from property that may be damaged if the system falls.
- Do not use the system to lift or hoist anything. The mechanism is designed to lift only the weight of the backboard and rim. Do not hang anything from the handle, rim, backboard, or lifter arms as this will damage the system and void the warranty.



AVERTISSEMENT

FAUTE DE NE PAS SUIVRE CES AVERTISSEMENTS, VOUS RISQUEZ DE CAUSER DES BLESSURES GRAVES ET/OU DES DOMMAGES À L'ÉQUIPEMENT.

Le propriétaire doit s'assurer que tous les joueurs connaissent et appliquent les règles suivantes afin d'utiliser l'équipement en toute sécurité.

- Ne vous suspendez pas à l'anneau.
- Lors d'un match, particulièrement dans le cas des smashes, le visage du joueur ne doit pas faire face au panneau, à l'anneau, ni au filet. Le joueur risque de graves blessures si ses dents ou son visage entrent en contact avec le panneau, l'anneau, ou le filet. Les joueurs doivent toujours porter un protège-dents lorsqu'ils jouent.
- Ne glissez pas, ne grimpez pas, et ne jouez pas sur la base ou le poteau.
- Remplissez complètement la base selon les instructions du fabricant. Ne laissez jamais l'unité debout de plein pied sans avoir d'abord rempli la base avec un poids ou l'équipement pourrait basculer rapidement et causer de graves blessures.
- Lorsque vous ajustez la hauteur ou lorsque vous déplacez l'équipement, gardez vos mains et doigts loin des pièces mobiles.
- Ne permettez pas aux enfants de déplacer ou d'ajuster l'équipement.
- Ne portez pas de bijoux (bagues, montres, colliers, etc.) lorsque vous jouez. Ces objets pourraient s'accrocher au filet.
- La surface sur laquelle est posée la base doit être lisse et sans gravure ou tout autre objet qui pourrait trouer la base entraînant ainsi une fuite ce qui pourrait faire basculer l'équipement.
- Gardez de l'eau et de la matière organique loin de la base. Le gazon, les déchets, etc. pourraient provoquer la corrosion et/ou la détérioration.
- Une fois par mois, vérifiez que le poteau et toutes les pièces en métal ne montrent pas de signes de corrosion (rouille, piqûres, écaillage). Enlevez toute la rouille et repeignez complètement avec une peinture pour extérieur. Si la rouille a pénétré une des pièces en acier, vous devez remplacer immédiatement la pièce en question.
- A chaque fois que vous allez utiliser l'équipement, vérifiez d'abord l'équilibre, la possibilité de pièces desserrées ou usées, la stabilité de l'équipement et tout signe de corrosion ou réparation nécessaire avant utilisation.
- Ne jouez jamais avec un équipement endommagé.
- N'utilisez pas l'équipement lors de fortes rafales de vent ou de mauvais temps. L'équipement pourrait basculer. Placez l'équipement dans un endroit abrité du vent ou loin des structures qu'il pourrait endommager s'il basculait et loin.
- N'utilisez pas l'équipement pour lever ou soulever quoique ce soit. Son mécanisme a été conçu uniquement pour soutenir le poids du panneau et de l'anneau. N'accrochez rien au manche, à l'anneau, au panneau ni aux leviers sous peine d'endommager l'équipement et d'annuler la garantie.

ADVERTENCIA

SI NO SE OBEDECEN ESTAS ADVERTENCIAS PUEDEN PRODUCIRSE GRAVES LESIONES Y/O DAÑOS A LA PROPIEDAD.

El propietario del sistema debe asegurarse de que todos los jugadores conozcan y respeten estas reglas para que el sistema se use en forma segura.

- No cuélguese del aro.
- Durante el juego, especialmente al embocar violentamente de alto, la cara de los jugadores debe mantenerse alejada del tablero, el aro y la red. Pueden producirse lesiones graves si los dientes o la cara entran en contacto con el tablero, el aro o la red. Los jugadores deben usar un protector bucal durante el juego.
- No se deslice, no trepe ni juegue sobre la base o el poste.
- Llene la base completamente siguiendo las instrucciones del fabricante. Nunca deje la unidad en posición de uso sin haber llenado previamente la base con material de contrapeso, pues el sistema podría tumbarse rápidamente y causar graves lesiones personales.
- Mantenga las manos y los dedos alejados de las piezas móviles cuando regule la altura o desplace el sistema.
- No deje que los niños regulen ni desplacen el sistema.
- No use joyas (anillos, relojes, collares o gargantillas, etc.) durante el juego. Estos objetos pueden engancharse en la red.
- La superficie donde se coloque la base debe estar lisa y desprovista de piedras, grava u otros objetos. Las perforaciones pueden originar pérdidas, y éstas pueden hacer que el sistema se tumbe.
- Guarde agua y materia orgánica. Césped, basura, etc., podrían causar corrosión et/o deterioros.
- Controle el poste y todas las piezas metálicas una vez al mes en busca de signos visibles de corrosión (oxidación, picaduras, escamado). Elimine todo rastro de óxido y vuelva a pintar con esmalte para exteriores. Si el óxido ha penetrado cualquier pieza de acero, reemplace esa pieza de inmediato.
- Inspeccione el sistema antes de cada uso para verificar que esté adecuadamente contrapesado, que los elementos de fijación no estén flojos, que no haya desgaste excesivo, inestabilidad ni signos de corrosión. Si encuentra irregularidades, repárelas antes de usar el sistema.
- Nunca juegue con un equipo dañado.
- No use el sistema en presencia de vientos fuertes o condiciones climáticas adversas, ya que puede tumbarse. Coloque la unidad en su posición de almacenamiento y/o en una zona a resguardo del viento, lejos de propiedades personales que puedan dañarse si el sistema se cae.
- No use el sistema para levantar ningún objeto. El mecanismo está diseñado para elevar solamente el peso del tablero con el aro. No cuelgue nada de la agarradera, el aro, el tablero ni los brazos de elevación, ya que esto puede dañar el sistema y anular la garantía.

Lifetime Products, Inc., Clearfield, UT 84016

www.lifetime.com

1-800-225-3865

4/24/2020

1176617



REGISTER YOUR PRODUCT ONLINE AT WWW.LIFETIME.COM

At Lifetime®, we are committed to providing innovative and quality products. While registering, you will have the opportunity to give us your feedback. Your input is valuable to us.

- You can also opt in to receive new product notifications or promotions.
- In the unlikely event of a product recall or safety modification, your registration provides the information we need to notify you directly.
- Registration is fast, easy, and completely voluntary.

LIFETIME'S PROMISE TO YOU:

Maintaining your privacy is our long-standing policy at Lifetime®. And you can rest assured that Lifetime® will not sell or provide your personal data to other third parties, or allow them to use your personal data for their own purposes.

We invite you to read our privacy policy at www.lifetime.com

REGISTER today!



5-YEAR LIMITED FACTORY WARRANTY

THE MANUFACTURER RESERVES THE RIGHT TO MAKE SUBSTITUTIONS TO WARRANTY CLAIMS IF PARTS ARE UNAVAILABLE OR OBSOLETE.

1. Lifetime basketball systems are warranted to the original purchaser to be free from defects in material or workmanship for a period of five years (60 months) from the date of original retail purchase. The word “defects” is defined as imperfections that impair the use of the product. Defects resulting from misuse, abuse or negligence will void this warranty. This warranty does not cover defects due to improper installation, alteration or accident. This warranty does not cover damage caused by vandalism, rusting, “acts of nature” or any other event beyond the control of the manufacturer.
2. This warranty is nontransferable and is expressly limited to the repair or replacement of defective product. If the product is defective within the terms of this warranty, Lifetime Products, Inc. will repair or replace defective parts at no cost to the purchaser. Shipping charges to and from the factory or distribution center are not covered and are the responsibility of the purchaser. Labor charges and related expenses for removal, installation or replacement of the product or its components are not covered under this warranty.
3. This warranty does not cover scratching or scuffing of the product that may result from normal usage. In addition, defects resulting from intentional damage, negligence, unreasonable use or hanging from the rim will void this warranty.
4. Liability for incidental or consequential damages is excluded to the extent permitted by law. While every attempt is made to embody the highest degree of safety in all equipment, freedom from injury cannot be guaranteed. The user assumes all risk of injury resulting from the use of this product. All merchandise is sold on this condition, and no representative of the company may waive or change this policy.
5. This product is not intended for institutional or commercial use; Lifetime Products, Inc. does not assume any liability for such use. Institutional or commercial use will void the warranty.
6. Our goods come with guarantees that cannot be excluded under the Australian Consumer Law. You are entitled to a replacement or refund for a major failure and for compensation for any other reasonably foreseeable loss or damage. You are also entitled to have the goods repaired or replaced if the goods fail to be of acceptable quality and the failure does not amount to a major failure.
7. This warranty is expressly in lieu of all other warranties, expressed or implied, including warranties of merchantability or fitness for use to extent permitted by Federal and state law. Neither Lifetime Products, Inc., nor any representative assumes any other liability in connection with this product. This warranty gives you specific legal rights, and you may also have other rights which vary from state to state.

PLEASE INCLUDE YOUR DATED SALES RECEIPT AND PHOTOGRAPHS OF DAMAGED PARTS.

REPORT PRODUCT DEFECTS IN WRITING TO:

Lifetime Products, Inc., PO Box 160010 Clearfield, UT 84016-0010
or dial 1-800-225-3865 M-F 7 a.m. to 5 p.m. MST.

REGISTER YOUR PRODUCT FOR QUICKER CUSTOMER SERVICE.

Visit www.lifetime.com or dial 1-800-225-3865 to register your product today.

FOR INTERNATIONAL WARRANTY CLAIMS:

All warranty claims must be accompanied by a sales receipt. Report all warranty claims in writing to your regional sales support representative. Please include your dated sales receipt and photographs of damaged parts.
To identify the representative for your region, please visit: www.lifetime.com/international



www.lifetime.com



NOTES

ENHANCE YOUR LIFETIME® PURCHASE BY ADDING ACCESSORIES OR OTHER GREAT PRODUCTS

To purchase accessories or other Lifetime® products, visit us at:

www.lifetime.com
Or call: 1-800-424-3865

