

Universal HD



Safety Overview	2
MyLifter Safety	3
What's in the Box	4
Universal HD Installation.....	5
Step 1: Assemble Universal HD Frame	5
Step 2: Install Smart Track	6
Step 3: Install MyLifter Hoists	10
Step 4: Install Power Adapters and Cable Management Clips.....	13
Step 5: Attach Universal HD Frame to MyLifters.....	16

1. This is a **DO IT YOURSELF** project. Read and follow the installation instructions carefully. Failure to follow instructions could result in property damage, serious injury or death. If you have any questions or concerns about the quality of your ceiling structure discontinue installation and consult a structural engineer.
2. Do not attempt to install any SmarterHome product or device without a basic understanding of these installation instructions. If you are not confident locating and anchoring items to ceiling joists do not attempt this installation.
3. Do not exceed the stated weight limits. The weight limit is based on Smart Track and Universal HD rack being anchored to a wood framed garage. This system is not compatible if your house is constructed using metal studs.
4. Load the Universal HD rack evenly.



WARNING

Universal HD weight lifting capacity = 190 lbs

When using the MyLifter and related storage accessories:

- **Do NOT** use the MyLifter to lift people or animals.
- **Do NOT** climb or hang on the storage rack.
- **Do NOT** lift items while hands or other body parts are near the MyLifter device, lifting cables, storage accessories, etc.
- **Do NOT** stand under the MyLifter or any items that have been lifted by the MyLifter.
- **Do NOT** use the MyLifter to lift or lower items over people or animals.
- **Do NOT** exceed the lifting capacity of the MyLifters.
- **Do NOT** attempt to install/secure lifters to angled ceilings or walls. MyLifter units are designed to be secured to flat ceilings only.
- **Do NOT** install in any manner other than as specified in instructions.
- **Do NOT** attempt to lift unbalanced loads. Always balance items/loads before lifting.

**Inspect the MyLifter Cable(s)**

- Inspect the MyLifter cable(s) often/before each use to ensure it is properly seated on the pulley wheel. If the cable is tangled, damaged, or bent, stop using your MyLifter device immediately.

Avoid Electric Shock

- To avoid risk of electric shock and/or other potential injury **DO NOT** disassemble or open any SmarterHome device. All SmarterHome products are designed for indoor use only. Failure to follow these safety instructions could result in property damage, serious personal injury, or death.

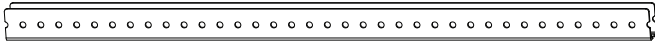

Modular Frame (x1)

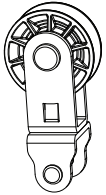

Pulley (x2)



Cotter Pins (x4)

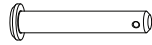

Clevis Pins (x4)

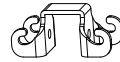

Hook (x2)

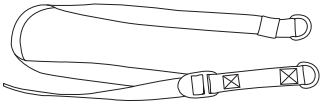

10 Foot Lifting Strap (x2)



MyLifters (x2)



Power Adapters (x2)

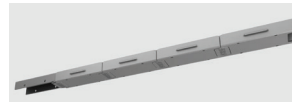

Smart Track & Hardware (x2)

Required Tools (not included)

- Drill
- Ratchet with 1/2" Socket
- Stud Finder
- Ladder
- Safety Glasses
- Pencil
- Tape Measure

Step 1: Assemble Universal HD Frame

1. Locate the two pulley blocks and the included cotter and clevis pins.
2. From either end of the frame, count eight holes in from the end and place a pulley on the frame and secure it with a cotter and clevis pin. (fig 1.1)
3. Place the remaining pulley on the opposite end of the frame by counting eight holes in from the end of the frame and securing the pulley in place using the cotter and clevis pins.
4. Hooks can be placed wherever they are needed. (fig 1.2)
5. The frame is now fully assembled. Set it aside for now. In a bit we'll attach it to the MyLifters.

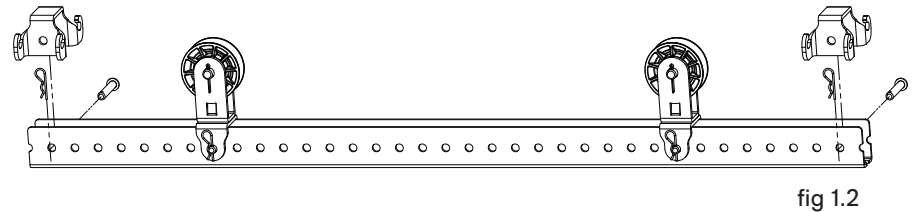
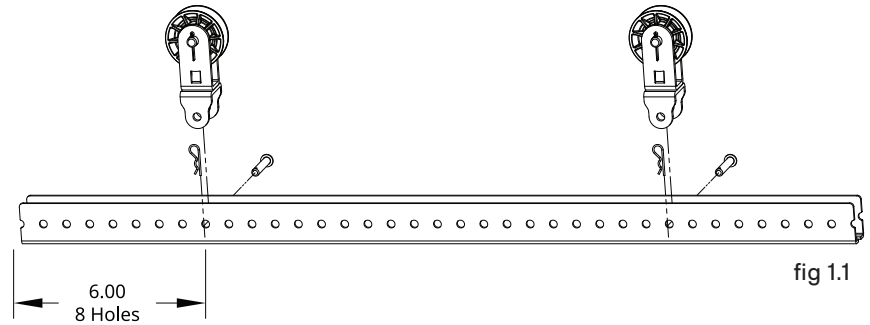

NOTE

NOTE: Make sure the clevis pins are properly seated to ensure the cotter pins stay in place.



Step 2: Install Smart Track

- Lag bolts used to secure Smart Track must be centered in ceiling joists.
- If you are not confident locating and anchoring items to ceiling joists do not attempt this installation.
- Smart Track is designed to be installed with two lag bolts. Load must only be applied between lag bolts.
- Smart Track is designed to be secured to flat garage ceilings. DO NOT mount the Smart Track to walls or angled ceilings. Failure to follow instructions could result in property damage, serious injury, or death.
- If you have any questions or concerns about the quality of your ceiling structure discontinue installation and consult a structural engineer.

Step 2: Install Smart Track (cont.)

1. Determine where to install your Universal HD rack. Be sure to take into consideration garage doors, overhead lights etc. when choosing your install location. Keep in mind you'll also need access to at least one power outlet to power the MyLifters.
2. Determine where each Smart Track will need to be installed. Note that joist direction will determine how you install Smart Track. (fig 2.1)
3. Use a stud finder to find the ceiling joist that is nearest to your desired installation location.
4. Mark the left edge of the joist. (fig 2.2)
5. Mark the right edge of the joist. (fig 2.3)
6. Mark the center of the joist. (fig 2.4)

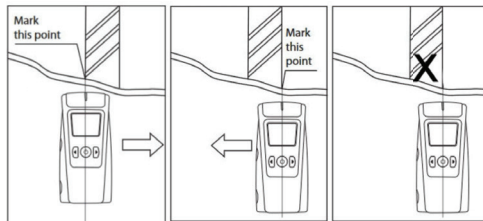
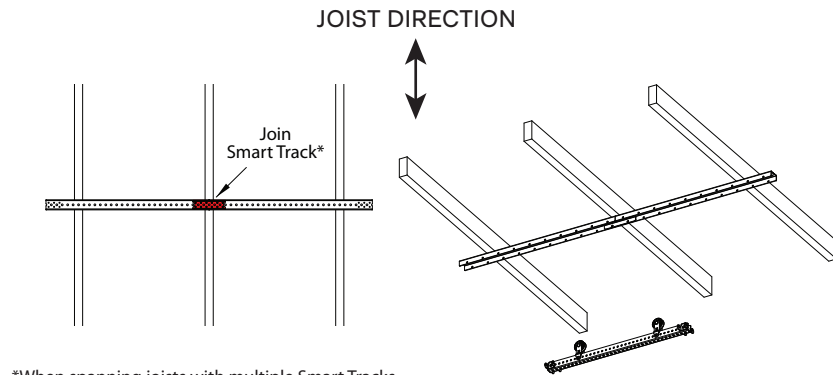
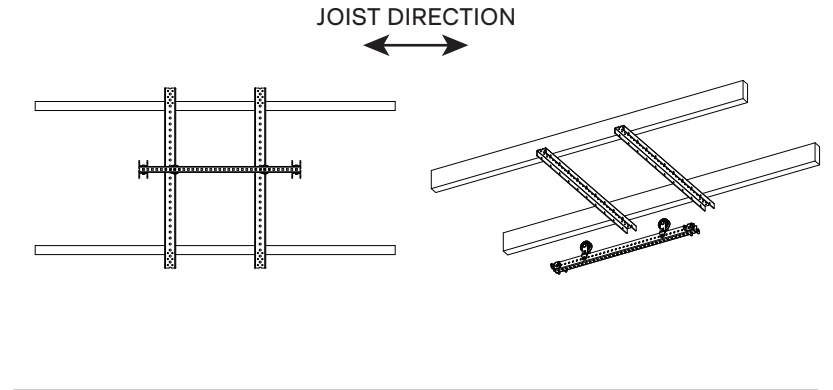

fig 2.2

fig 2.3

fig 2.4



*When spanning joists with multiple Smart Tracks, use the included red bracket and corresponding hardware to join the Smart Track together. A lag bolt should be used to secure Smart Track to each ceiling joist the combined Smart Track spans.

fig 2.1

Step 2: Install Smart Track (cont.)

7. Place the Smart Track over the ceiling joist center mark you made and use a pencil to mark where the lag bolts will be installed so you can drill the pilot hole. Be sure the marking is along the center of the ceiling joist.
8. Using the included 6mm drill bit, drill the first vertical pilot hole at least three inches into the center point of the ceiling joist mark that you made.
9. Use a ratchet with a 1/2 inch socket to attach the Smart Track to the ceiling using one of the included lag bolts and washers. Do not completely tighten the lag bolt at this point. (fig 2.2) **NOTE:** If the lag bolt turns freely, your pilot hole is likely not hitting the ceiling joist. If this is the case, find the center of the stud and drill a new pilot hole.

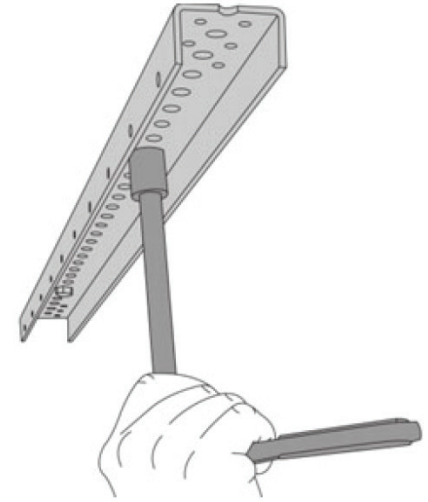

fig 2.2

**CAUTION**

Do NOT use an impact driver to insert the lag bolts into the stud. This could over tighten the screws causing them to fail, which may result in property damage, serious personal injury, or death.

Step 2: Install Smart Track (cont.)

10. If not already done, repeat steps 4-6 to find the center of the joist where you will secure the other end of the Smart Track.
11. Similar to the other end of Smart Track, place the Smart Track over the center mark you've just made for the ceiling joist and use a pencil to mark where the lag bolt should be installed. Be sure you are installing along the center of the ceiling joist.
12. Use a ratchet with a 1/2 inch socket to attach the Smart Track to the ceiling using one of the included lag bolts and washers. (fig 2.3) **NOTE: If the lag bolt turns freely, your pilot hole is likely not hitting the ceiling joist. If this is the case, find the center of the stud and drill a new pilot hole.**
13. Tighten both lag bolts so the Smart Track is flush and secure against the ceiling. **Do NOT use an impact driver to tighten the lag bolts into the stud. This could over tighten the screws causing them to fail, which may result in property damage, serious personal injury, or death.**
14. Repeat steps 2-14 for each remaining Smart Track that needs to be installed.

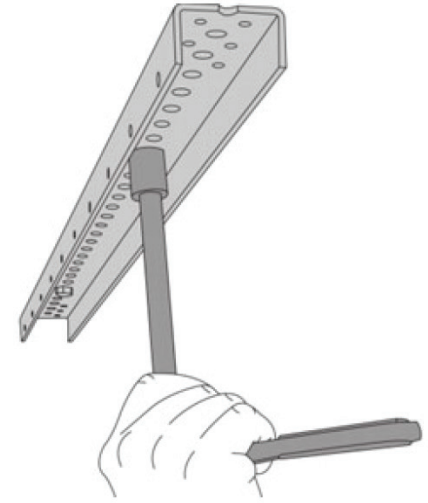

fig 2.3

**CAUTION**

Before moving to next step be sure that lag bolts for all Smart Track are tightened, flush and secure against the ceiling.

Step 3: Install MyLifter Hoists

1. Before installing the MyLifters onto the Smart Track, pair to each MyLifter using the MyLifter app. This is important to ensure you can troubleshoot any potential connection/pairing issues before installing them.
2. Download the MyLifter app from the App Store or Google Play (fig 3.1).
3. Open the app and tap “Add Devices” in the bottom right corner to open the “Available Lifters” screen.
4. Firmly press the Pair button next to the Status light on the MyLifter. (fig 3.2)
5. When the Status light blinks green, the MyLifter is paired with the app. On the “Available Lifters” screen, your newly paired MyLifter should be displayed with its corresponding MAC address as the default name. You can edit the MyLifter name by tapping “Edit” in the upper right corner. (fig 3.3)
6. Repeat steps 3-5 for all MyLifters that need to be paired.



fig 3.1

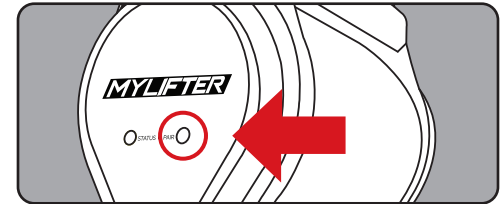

fig 3.2



fig 3.3

Step 3: Install MyLifter Hoists (cont.)

7. On the home page, click “Create Group” in the bottom left corner. Choose “Locked Group”.
8. On the “Select Devices” screen, select the MyLifters you just paired to so they are included in the group and give the group a name, such as 'Universal HD' in the "Name the Group" section. (fig 3.4 and 3.5)
9. Tap “Create Group” at the bottom of the screen and then “Got It” when the please confirm dialog opens. The “Device Control” screen will open.
10. To level each MyLifter in the group, click each MyLifter one-by-one (they’re listed at the bottom of the “Device Control” screen) and adjust the cable length so each MyLifter has the same amount of cable visible/extending from the cable guide. **NOTE: You may have to make additional adjustments once you’ve attached the Universal HD.**
11. Once you’ve leveled each MyLifter, tap “Set Group Level”.



fig 3.4

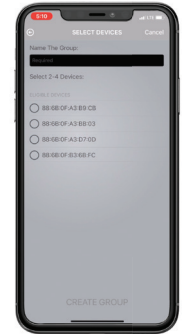

fig 3.5



NOTE

To make further adjustments at a future time, tap the “Help” button and select “Level Group”. Then tap on the MyLifter you’d like to adjust and make the necessary adjustments.

Step 3: Install MyLifter Hoists (cont.)

12. Now that you've paired to each MyLifter and created a group, the MyLifters can be installed on the Smart Track.
13. Each MyLifter must be placed on the Smart Track between two lag bolts to ensure proper support.
14. Distance between the MyLifters on the Smart Track should match the 15" distance between the two pulleys on the Universal HD frame. This is key to proper MyLifter operation and ensures the cables will be as vertical as possible. Failure to follow this guideline can damage the MyLifter. (fig 3.6)
15. To install MyLifters on the Smart Track, align the holes on the MyLifter frame with the holes on the Smart Track. **NOTE: All MyLifters should be installed with the DC power input end of the MyLifter facing in the same direction.** This is imperative to ensure proper operation of the MyLifter(s). (fig 3.6)
16. Insert the two included quick-release pins through the holes in the MyLifter frame and the Smart Track. Make sure the pins go all the way through both sides of the MyLifter frame and Smart Track. Repeat this for each MyLifter that you are installing.

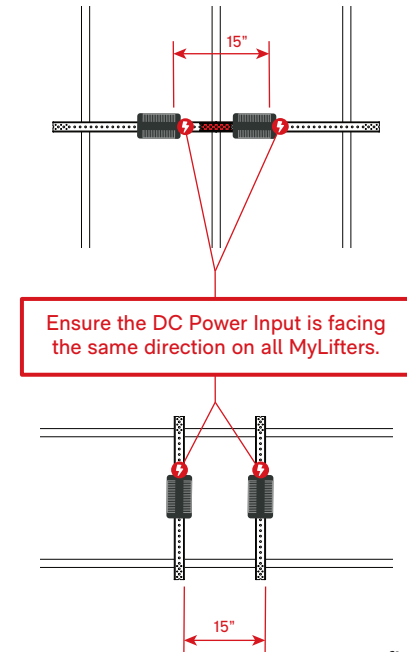

fig 3.6



NOTE

NOTE: Each MyLifter must be installed between two lag bolts and in the same orientation.

Step 4: Install Power Adapters and Cable Management Clips

1. For each MyLifter you've installed on the Smart Track, determine where the Power Adapter should be installed. The preferred location, if possible, is adjacent to the MyLifter.
2. Confirm the power cord attached to the Power Adapter will reach a power outlet and the DC cable will reach from the Power Adapter to the MyLifter. NOTE: Each Power Adapter is equipped with our patented power passthrough technology so you can power multiple MyLifters from one power outlet.
3. Clip the universal mounting bracket, included with the Power Adapter, onto the Smart Track making sure the plastic nubs snap into place. (fig 4.1)
4. Align the plastic pins on the universal mounting bracket with the holes on the back of the Power Adapter. Press the Power Adapter onto the pins and slide to lock it into place. (fig 4.2)

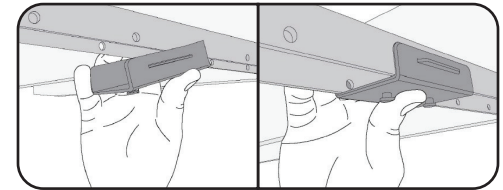

fig 4.1

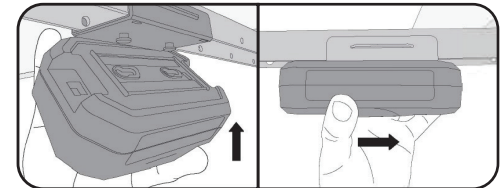

fig 4.2

Step 4: Install Power Adapters and Cable Management Clips (cont.)

5. To secure and organize the cables, determine where to place the cable management clips. (fig 4.3)
6. Peel the adhesive backing off a cable management clip and place it on the ceiling. Be sure to press firmly to ensure it sticks. (fig 4.3)
7. Secure the cable management clip with a screw, place all wires into the clip, and securely close the clip. (fig 4.4)
8. Repeat steps 5-7 for additional cable management clips to secure and organize cables.
9. You can also organize cables by winding the excess cable around the Power Adapter housing or placing the cable in the channel of the Smart Track. (fig 4.5)
10. Once you have organized the cables you can install the gray Smart Track cable covers. (fig 4.6)

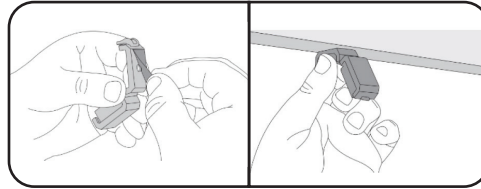

fig 4.3

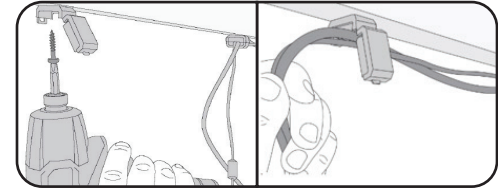

fig 4.4

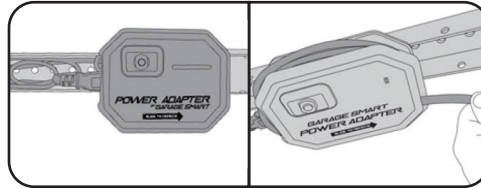

fig 4.5

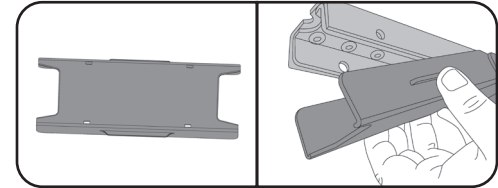
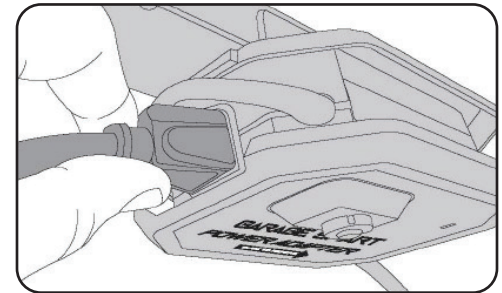
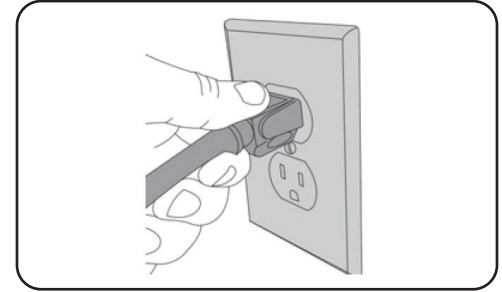

fig 4.6

Step 4: Install Power Adapters and Cable Management Clips (cont.)

11. Once all Power Adapters have been installed, connect them to the closest outlet (this may be a wall outlet or the power pass through on another Power Adapter).
12. The LED on the Power Adapter will glow when powered on.
13. If you haven't already, connect the DC cable from the Power Adapter to their corresponding MyLifter.



NOTE

Additional Garage Smart products with AC connections can be powered by connecting their AC cable to the AC outlet on the Power Adapter.

Step 5: Attach Universal HD Frame To MyLifters

1. On the "Device Control" screen, press and hold the Manual Lower arrow to let out enough cable to run through the pulley block and back up to the Smart Track. (fig 5.1)
2. Run each cable through the pulley block and attach it to the Smart Track using the provided carabiners. Ensure cables are not twisted. NOTE: The carabiner must be placed in the first hole next to the MyLifter on the end with the DC power cable. (fig 5.2) Failure to do so can damage the MyLifter.
3. Make sure that the cables are as vertical as possible. Angled cables will damage the MyLifter. (fig 5.2)
4. On the "Device Control" screen use Manual Lift to adjust the cables and take excessive slack out of the cables without lifting the Universal HD off the floor. Now set the Smart Low point. (fig 5.1)
5. To make further adjustments and ensure your Universal HD is level, tap the "Help" button and select "Level Group". Then tap on the MyLifter you'd like to adjust and make the necessary adjustments.

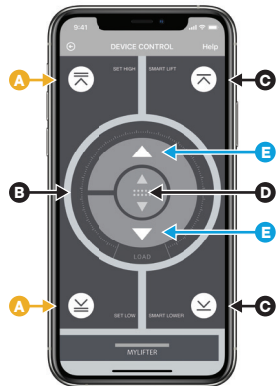

- A. SET HIGH AND LOW POINTS**
Program Smart High and Smart Low points for safety and convenience.
- B. LOAD GAUGE**
Indicates the percentage of weight MyLifter is lifting relative to its lifting capacity.
- C. SMART LIFT AND SMART LOWER**
Lift and lower your items to preset Smart High and Smart Low with one tap.
- D. VARIABLE SPEED CONTROLLER**
Press and hold to activate variable speed slider to lift/lower ensuring perfect placement of your items.
- E. MANUAL LIFT OR LOWER BUTTONS**
Press and hold these buttons to manually lift or lower your items at full speed.

fig 5.1

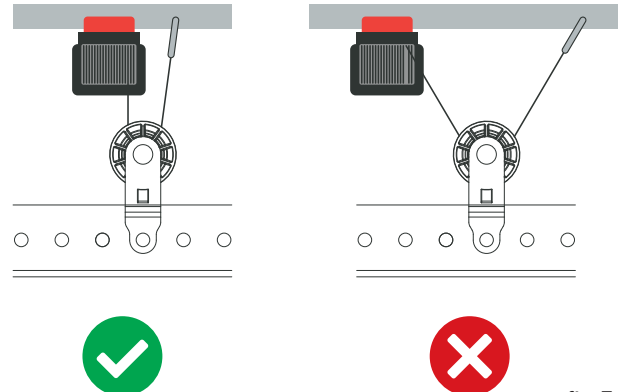

fig 5.2

Step 5: Attach Universal HD To MyLifters (cont.)

6. To attach item(s) to the Universal frame, use the included D-ring lifting straps to secure the item(s) to the frame. Make sure the item(s) are securely held in place by the straps and cannot slide out.
7. When loading (and during subsequent operation) be sure to arrange the item(s) so the weight is dispersed as evenly as possible.
8. Your Universal is ready for use. Double check to make sure all D-rings are properly secured to the hooks before lifting.
9. The first time you raise the Universal to the ceiling be sure to set the Smart High point. (fig 5.1 on previous page) This will keep you from running items into the ceiling. Keep in mind the high point may need to be adjusted if the height of the items you are storing changes.
10. Review the safety instructions at the beginning of this manual to ensure safe operation of your Universal.



CAUTION

**The Universal HD Lifter has a net weight lifting capacity of 190 pounds.
Attempting to lift more weight may cause property damage, serious personal injury, or death.**