

Club Car DS Console

We are striving to build a reliable brand of golf carts parts and accessories.

Hope this manual can assist you to easier install.

For more technical support, please reach us via

Website : www.10101.com

Email : sale_service@10101.com

Facebook : zhong zaiyang

Youtube : 10L0L

Contents	Qty	Installation Tools	Qty
Console.....	1	Double-Stick Tape.....	1
Circle Blade.....	1	Electrical Tape.....	1
4*10mm Screws.....	4	Cross Screwdriver.....	1
USB Wire.....	2	Scissors.....	1
Template Paper.....	1	Electric Drill.....	1

See Figure 1



Installation Tools



1. Wiring Steps

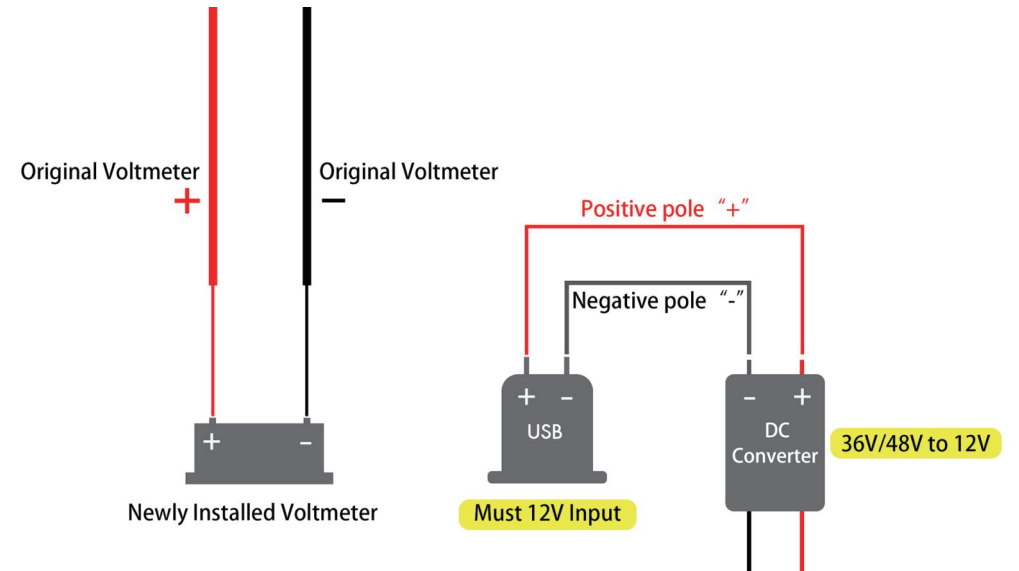

2. Power Off.

See figure 2



3. Unscrew the Console.

See figure 3



4. As Shown, Keep All the Ports Untouched.

See figure 4

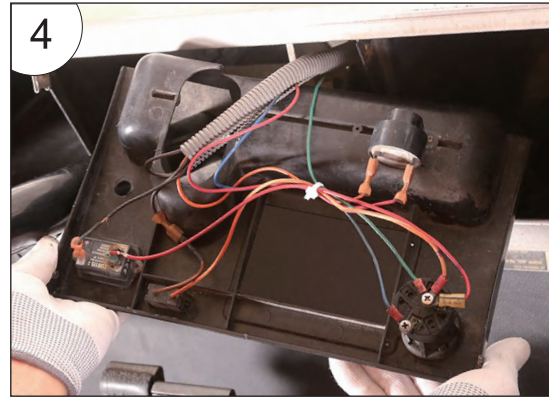

5. Cut the Template Paper into the Matching Shape.

See figure 5

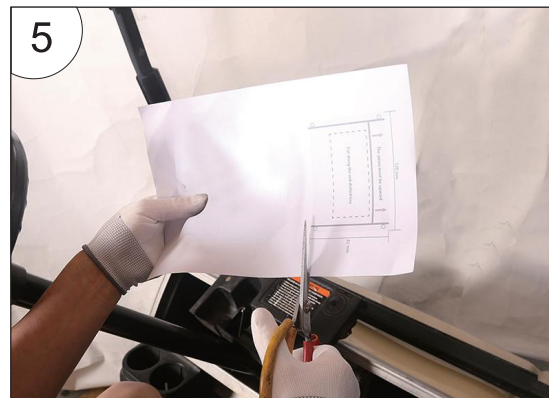

6. Stick the Template Paper on the dashboard with Double-sided Tape.

See figure 6



7. Install the Circle Blade on the Electric Drill.

See figure 7



8. Cut along the Dotted Line.

See figure 8



9. See the figure.



See figure 9

10. Tighten with 4*10mm Screws.



See figure 10

11. Insert red wire to "+", black wire to "-" of the USB Ports

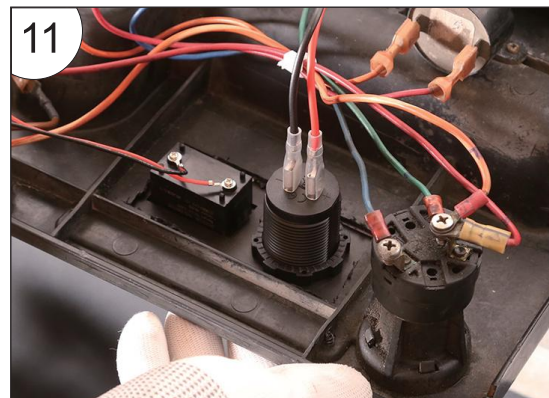

See figure 11

12. Red wire connect to DC converter positive end, Black wire connect to DC converter negative end.

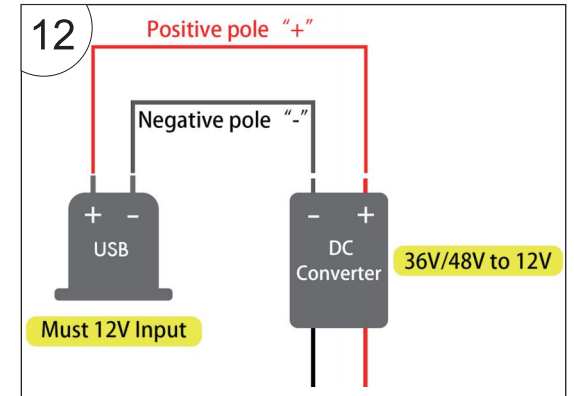

See figure 12

13. Cut and Strip the Wire of Negative Electrode (Black).

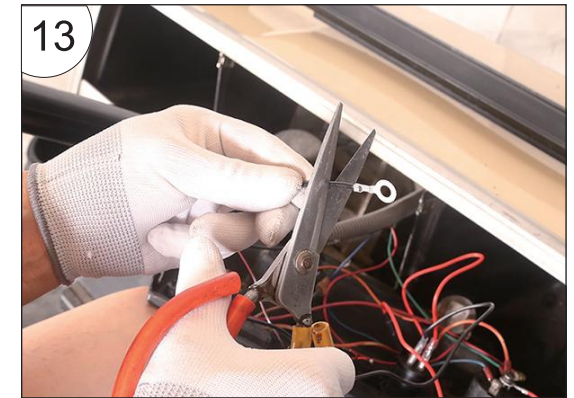

See figure 13

14. Cut and Strip the Wires of Voltmeter (Black & Red).

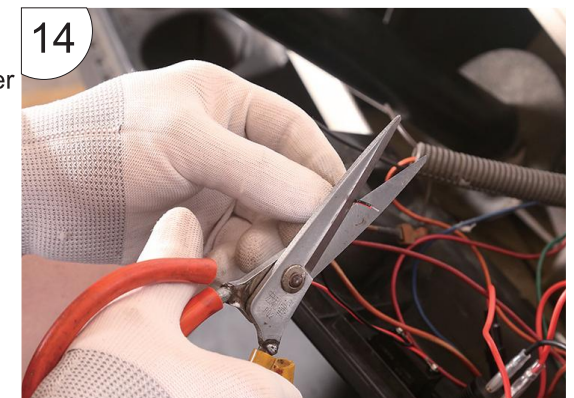

See figure 14

15. The 2 Cut and Stripped Wires.

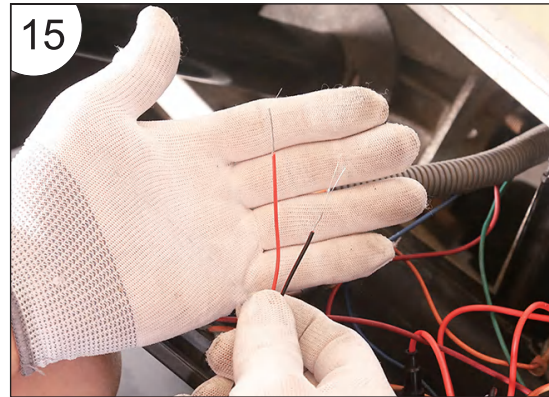

See figure 15

16. Strip the Original Wires of the Voltmeter (Do Not Cut).



See figure 16

17. See the figure.

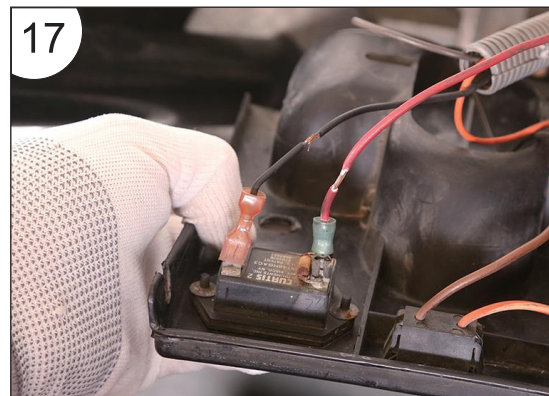

See figure 17

18. Black Connect to Black, Red Connect to Red.

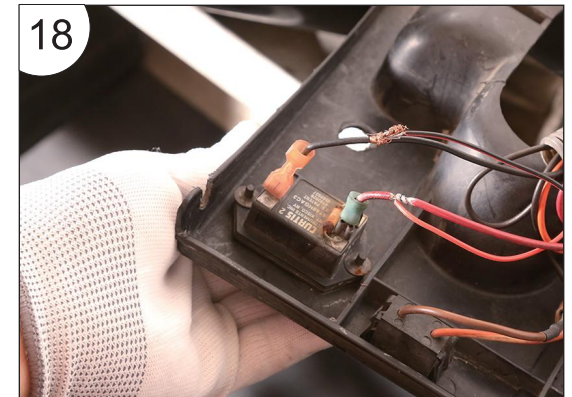

See figure 18

19. Wrap them up with Electric Tape.



See figure 19

20. All Connected.

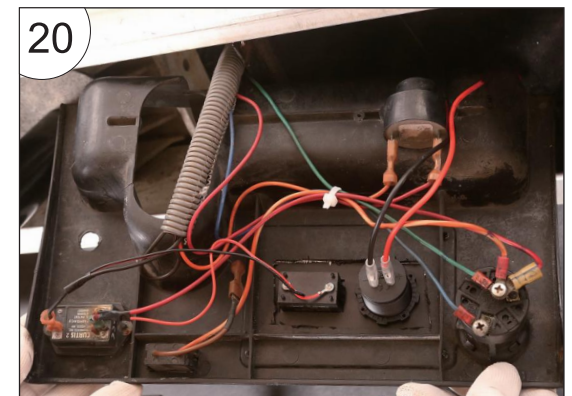

See figure 20

21. Tighten the Screws.



See figure 21

22. Installation Completed.



Sticker Part

Please Note: Cut along the red dotted line, and drill at the red circles. Avoid drilling or cutting the dark grey line!

