



ILLUMINAZIONE 2014

LIGHTING

# Armonie d'Epoca



Distribuito da:

METAL GROUP S.p.a.

Viale Europa 1/3/5 Cerea (VR) Italia

Tel. + 39 0442 83777 Fax + 39 0442 370243

E-mail: [marketingms@metalstyle.it](mailto:marketingms@metalstyle.it)

[www.metalstyle.it](http://www.metalstyle.it)

**Armonie d'Epoca**  
**di Ubaldi Massimo**

Via Cristoforo Colombo, 21/c  
05100 Terni - Italia  
Tel. + 39 0744 423928  
e-mail: [armoniedepoca@gmail.com](mailto:armoniedepoca@gmail.com)  
[www.armoniedepoca.com](http://www.armoniedepoca.com)



La rinnovata passione per il restauro ed il recupero delle belle cose del passato coinvolge un numero sempre più consistente di persone e "Armonie d'epoca factory" interpreta con il proprio lavoro il desiderio diffuso di ridare vita ad oggetti che hanno valore profondo perché risvegliano emozioni dimenticate. Grazie ad un efficace ricerca che nasce dall'amore per le forme del passato, "Armonie d'epoca" propone oggetti che conservano il fascino irresistibile dei pezzi originali, perché sono costruiti con cura artigianale e con attenzione ai dettagli. "Armonie d'epoca" propone complementi d'arredo e accessori creati appositamente per le esigenze di produzione e restauro in stile ed oggi va incontro alla necessità degli operatori nel settore con una vasta gamma di prodotti in ferro, trattati secondo un processo specifico che riproduce il calore del pezzo antico. La nuova serie di oggetti in ferro è stata creata appositamente per il restauro e la costruzione di portali porte e finestre ed arredamenti in genere di antichi casolari, cascine e ville.

Sono gli oggetti del desiderio delle persone più raffinate. Dall'età del Medioevo mantengono intatta la loro manifattura creativa, il loro fascino ben custodito, la preziosa qualità che li rende unici... senza mai perdere la loro integrità.

### **Gli ornamenti d'arredo in ferro.**

La ripetizione di un gesto, giorno dopo giorno, per ore, minuti, anni. Potrebbe sembrare un'assurda alienante ripetizione, invece ogni volta qual gesto palpita un'emozione, di qualcosa che è molto simile alla gioia. Quel tratto sicuro della mano dà vita a una piccola meraviglia, a volte infinitesimale... impossibile se il fabbro forgiatore non è in pace con se stesso. Alla base di quel gesto si intuisce una sperimentazione, la sofferenza della ricerca fino al senso di momentanea vittoria... fino al prossimo progetto e alla prossima sfida.

Siamo in Umbria, nel cuore dell'Italia tra lo sfarzo delle opere dell'impero Romano e l'alta rivelazione artistica dei maestri toscani, nella nostra terra, senza interruzioni da tre generazioni... dal tempo della prima guerra mondiale e dalla ricostruzione dell'Italia. Nell'azienda si lavora con la collaborazione di anziani maestri della forgiatura dei metalli con abili decoratori e una squadra di abili operai. Si riproducono oggetti d'arredo in ferro storici, ma se ne creano sempre di nuovi e soprattutto si sperimentano nuove forme, con sensibilità e acuto spirito di osservazione.

Ubaldi Massimo di ciò che riproduce, ne è fiero ed i suoi prodotti vivono nella sua anima. Senza questo sentimento interiore i suoi oggetti non produrrebbero nulla di efficace e di duraturo. Chi non è capace di interpretare questo spirito creativo non potrà mai apprezzare interamente e comprendere la storia che l'oggetto lascia trapelare. Qualcosa di molto più profondo che un semplice godimento estetico.

Capire cosa c'è dietro significa essere consapevoli del valore globale di una lavorazione in ferro e questo giustifica il suo costo. Non è una sola questione di qualità. Nei nostri laboratori, conservati proprio come officine di un tempo, uomini modellano i ferri come i Medioevali erano dediti alle loro opere. Sembrano lasciare fuori i tumulti della vita. Su un tavolino spartano il pasto del mezzogiorno, è un pane, una mela con un termos per una bevanda calda. Tutto il resto è concentrazione...quasi meditazione. Attraverso la mano che stringe il martello passa una corrente di armonia senza la quale il soggetto perde ogni senso. E' tutto qui il valore di una manualità che è stata tramandata da una generazione all'altra e l'archivio delle sagome e delle forme è lì a testimoniare l'impresa. Centinaia di matrici ricordano i lavori eseguiti prima per i nobili e poi anche per la comune borghesia.

L'impegno degli artisti del passato è l'eredità di ciò che oggi me stesso rappresento nel catalogo **Armonie d'epoca.**

**Ubaldi Massimo**

*Armonie d'Epoca Company meets the increasing passion of the public for wrought-iron objects and furniture, with their unique, charming, old style taste.*

*Our handicraft production is backed by skill, perseverance and dedication. That's why we never regard our work as hard, as it pays us back with deep satisfaction and emotions. The love of the artisan for beautiful old shapes is essential to reproduce the warmth and the irresistible charm of the original pieces and satisfy the taste of the most discerning customers.*

*Starting from the Etruscan-Roman age and notably in the Medieval period, up to nowadays, Umbria, our homeland, located in the heart of Italy, has been the cradle of blacksmithing craftsmanship. Our inherited archive of hundreds of moulds is there to remind us of the finest pieces of work, made for the most prestigious families through time.*

*At Armonie d'Epoca Company, we take pride in preserving this tradition and are well determined to keep it alive.*

*Massimo Ubaldi is the direct heir of a family whose experience in blacksmithing has been handed down to three generations, since the First World War, following through Italy's reconstruction. Assisted in his workshops by Tuscan art masters, he lavishes all his love and creative spirit in the achievement of his wrought-iron creations. Hence their added value and exquisite harmony.*

*It is our wish, by presenting this catalogue, to convey these sensations to our esteemed customers.*

UBALDI MASSIMO



# CERTIFICATO DI GARANZIA

## MANUFACTURER'S CERTIFICATE



www.armoniedepoca.com

Si garantisce che la lavorazione di questo prodotto è completamente eseguita a mano, lievi imperfezioni o difformità non sono difetti ma caratteristiche. Si garantisce che il trattamento è realizzato con prodotti altamente anticorrosivi e duraturi nel tempo. Il design rispetta l'antica tradizione di accessori per la casa rurale italiana.

*It is guaranteed that this product's manufacture is entirely handmade. Slight imperfections in products aren't defects, but peculiarity. It is also guaranteed that the traditional systems' treatment is carried out only with specific, life guaranteed and highly anticorrosive products. Design fully respects the Italian rural house's traditions.*

I nostri prodotti sono tutti corredati da certificato di garanzia

*All our products are complete with manufacturer's certificate*



Nell'anno 2001, a testimonianza della professionalità l'Azienda Giusti Armonie d'Epoca è stata insignita del premio Italia che Lavora

*In 2001 "Giusti Armonie d'Epoca" has received the price "Italia che Lavora" witnessing its professionalism*



"WORKING ITALY" PRICE WINNER



## CONDIZIONI GENERALI DI VENDITA

**Prezzi** : i prezzi si intendono per merce resa franco fabbrica ed al netto di ogni spesa accessoria (imballo, trasporto, spese postali, incasso, ecc.), in Euro, IVA esclusa .

Ci riserviamo, in qualsiasi momento di adeguare i prezzi indicati nel presente listino, che comunque scadranno dal 31.12.2016. Dopo tale data ogni cliente è tenuto ad informarsi, per ogni ordine, degli eventuali nuovi prezzi .

**Ordinazioni** : gli ordini diretti o indiretti si considerano assunti solo dopo l'emissione della nostra conferma d'ordine. I quantitativi ordinati devono essere conformi alle confezioni, se accettate, saranno soggette ad una maggiorazione non inferiore al 10% del prezzo di listino. Il minimo spedibile è di Euro 100 netto. Per importi inferiori a Euro 100 netto verrà addebitato il 10% in più per le maggiori spese amministrative .

**Consegna**: i termini di consegna esposti nelle conferme d'ordine hanno unicamente valore indicativo. In ogni caso, si riferiscono alla probabile data di consegna della merce al vettore. Non sono ammessi annullamenti o modifiche durante l'esecuzione dell'ordine che inizierà dal giorno successivo alla data in cui viene emessa la conferma d'ordine. La mancata o ritardante esecuzione di una parte o di tutto l'ordine, per cause di forza maggiore, non potrà dare diritto al Committente di annullare l'ordine stesso o di richiedere il risarcimento di eventuali danni.

**Pagamento**: i pagamenti sono validi unicamente se eseguiti alla nostra Sede in Terni. Trascorso il termine stabilito in fattura per il pagamento tramite Ri.ba, decorrono gli interessi di mora al tasso bancario, e nella successiva fattura verranno addebitate Euro 10.00 nette per “oneri insoluto e spese bancarie”.

La presentazione di qualsiasi reclamo non dispensa il compratore dal pagamento della fattura alla scadenza stabilita .

Il costo del taglio a misura delle aste per tenda verrà conteggiato al netto del costo di Euro 3.00 cadauno .

**Imballi**: gli imballi vengono fatturati al prezzo di costo e non vengono accettati di ritorno; l'importo è assoggettato ad IVA.

**Spedizioni**: la merce viene resa franco nostro stabilimento e viaggia a rischio e pericolo del Committente. La nostra responsabilità termina all'atto della consegna della merce al vettore .

**Varie**: Non si accettano resi di merce se non espressamente autorizzati e franchi di ogni spesa al magazzino della nostra sede.

Trascorsi 8 giorni dall'arrivo della merce a destino, senza osservazioni per iscritto da parte del destinatario, le nostre fatture si intendono approvate ed accettate e nessun reclamo potrà più essere emesso. Gli eventuali difetti sui prodotti o errori di spedizione potranno impegnarci solo alla sostituzione o integrazione del materiale senza rifusione di eventuali danni. Ci riserviamo di apportare modifiche ai prodotti ed eventualmente di eliminare dalla produzione, senza obbligo di preavviso e ciò non ci impegnerà alla sostituzione dei materiali giacenti presso i Clienti . I prezzi unitari e le misure dei nostri prodotti si intendono approssimativi .

**Foro competente**: per qualsiasi controversia è competente il Foro di Terni. Tutte le suddette condizioni si intendono accettate col riferimento dell'ordine e qualunque condizione in deroga o comunque non contemplata nelle presenti “condizioni generali di vendita”, sarà valida solo se risultante da accordo scritto.

## COME RAGGIUNGERCI: HOW TO COME HERE:



IN AUTO: dall'autostrada Al Milano-Roma uscita Orte direzione Terni-Spoleto  
Prendere la prima uscita Terni ovest

IN TRENO: da Roma Termini prendere la linea per Ancona e scendere ad Orte  
proseguire con diretto per Terni

IN AEREO: l'aeroporto più vicino e quello internazionale di Fiumicino (Roma)

*Lampade in ferro forgiato*

FORGED IRON LAMPS



*in ferro forgiato*

L  
E  
S  
E  
E  
E  
E

# Art. 5555

Applique  
WALL LIGHT

Lampada in stile medievale di medie dimensioni, per uso interno e porticati. Trasformabile in porta cero.

MEDIEVAL STYLE LAMP MEDIUM SIZE, FOR INTERIORS AND PORCH. ON REQUEST IT CAN BE TURNED INTO A CANDLE HOLDER.

IP 20 CE  
max 60 W E 27  
230 V 50 Hz

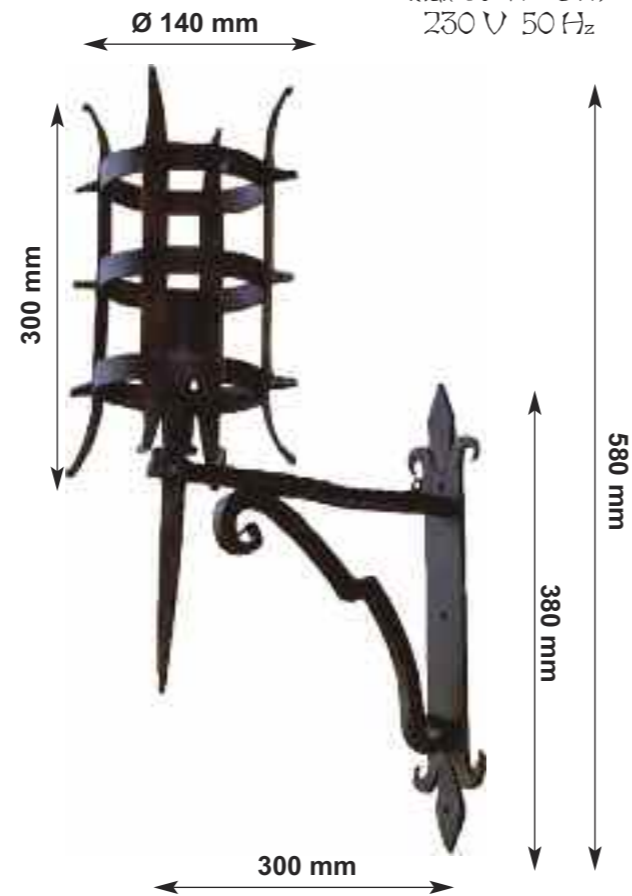

# Art. 5560

Applique  
WALL LIGHT

Lampada in stile medievale con due luci di medie dimensioni per uso interno e porticati. Trasformabile in porta cero.

MEDIEVAL STYLE TWIN LIGHT LAMP MEDIUM SIZE, FOR INTERIORS AND PORCH. ON REQUEST IT CAN BE TURNED INTO A CANDLE HOLDER.

IP 20 CE  
max 60 W x2 E 27  
230 V 50 Hz

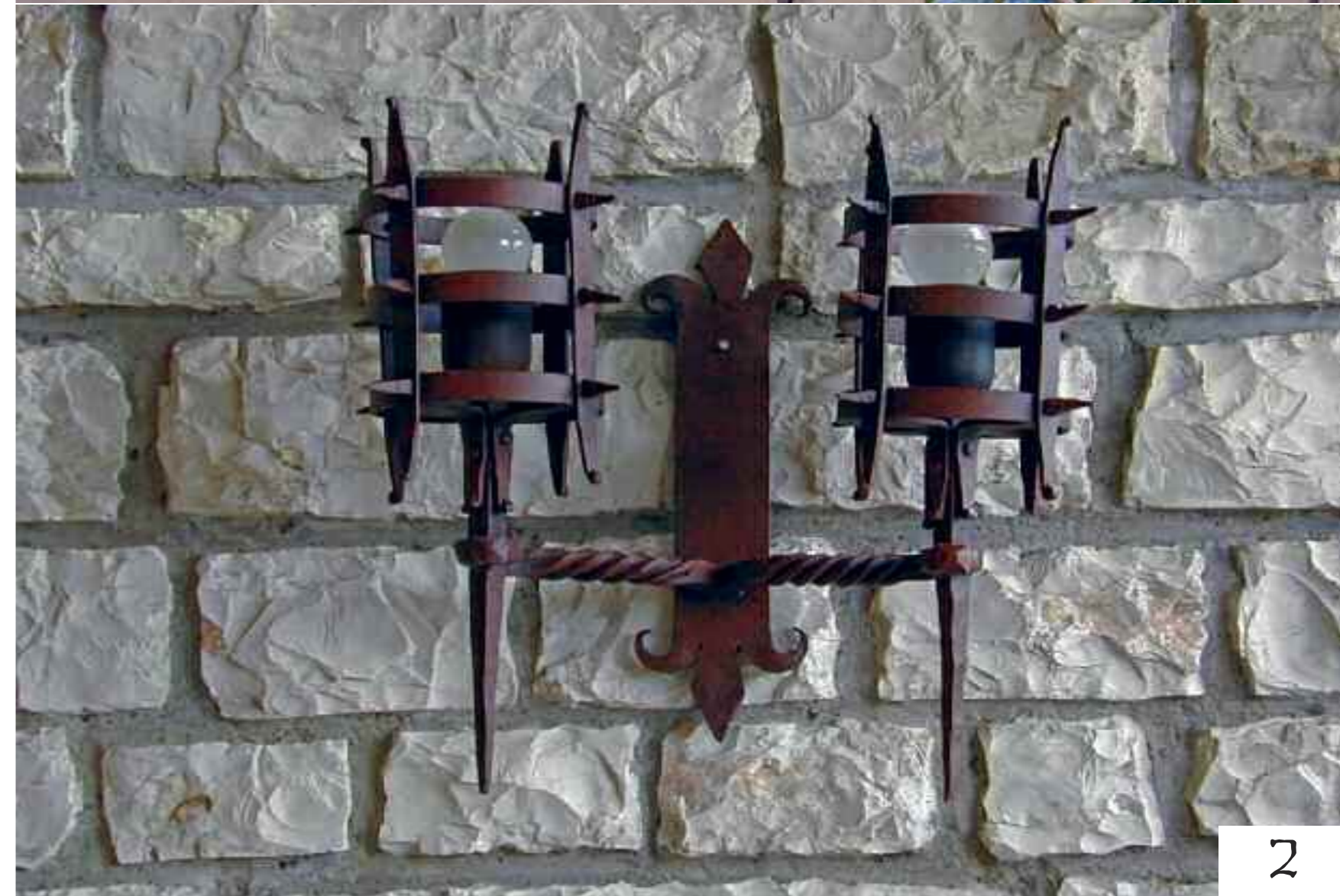
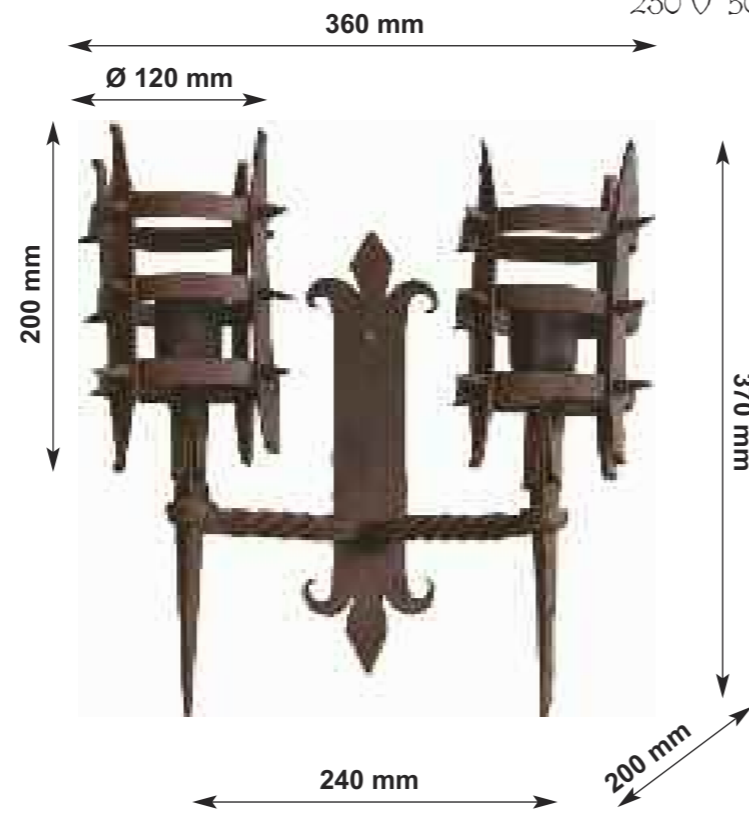

# Art. 7021

Lampione per arredo urbano

LAMP POST FOR STREET FURNITURE

Lampione ad un braccio con lampada cilindrica e vetro trasparente, a fasce con chiodi forgiati, controbasse a murare.

GLASS CYLINDRICAL LAMP, WITH BRACKETS AND FORGED NAILS.

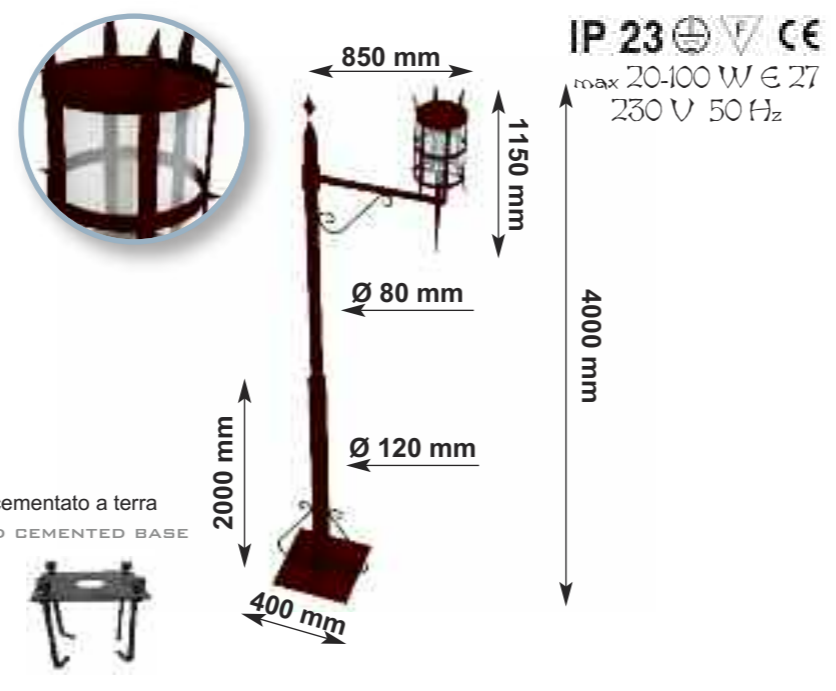

basamento cementato a terra  
ON GROUND CEMENTED BASE



IP 23 CE  
max 20-100 W € 27  
230 V 50 Hz

# Art. 7022

Lampione per arredo urbano

LAMP POST FOR STREET FURNITURE

Lampione a due bracci con lampada cilindrica a fasce con chiodi forgiati

TWO ARM GLASS CYLINDRICAL LAMP, WITH BRACKETS AND FORGED NAILS.

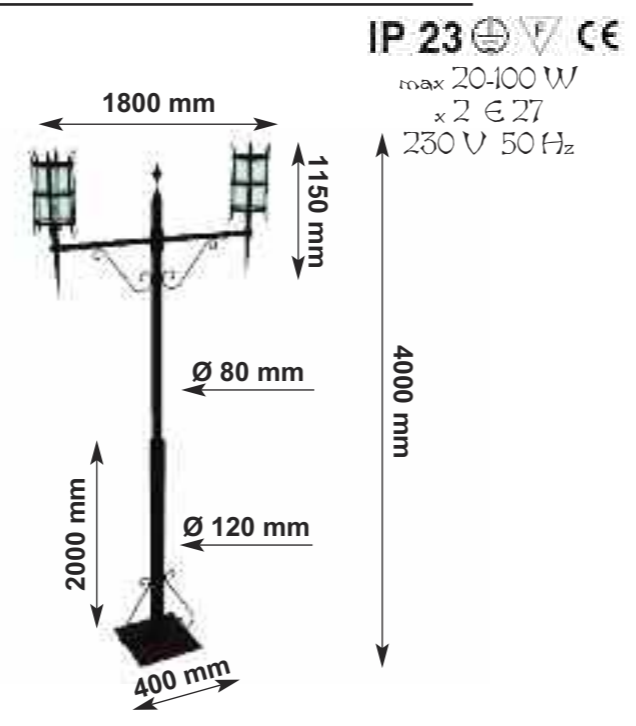

basamento cementato a terra  
ON GROUND CEMENTED BASE



IP 23 CE  
max 20-100 W  
x 2 € 27  
230 V 50 Hz

# Art. 7023

Lampione per arredo urbano

LAMP POST FOR STREET FURNITURE

Lampione a tre bracci con lampada cilindrica e decorazione medioevale a fasce con chiodi forgiati

THREE ARM GLASS CYLINDRICAL LAMP, WITH BRACKETS AND FORGED NAILS.

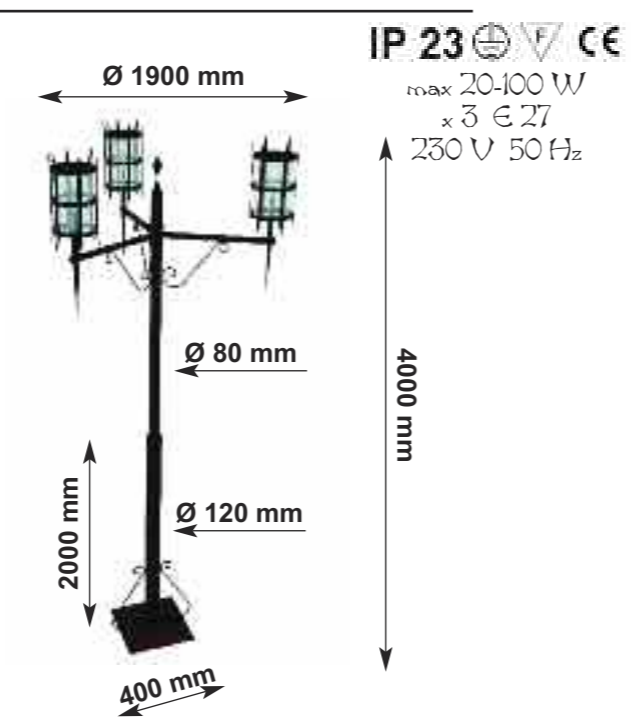

basamento cementato a terra  
ON GROUND CEMENTED BASE



IP 23 CE  
max 20-100 W  
x 3 € 27  
230 V 50 Hz





## Art. 5575

Lampione da giardino

GARDEN LAMP POST

Tipico lampione da giardino in stile medievale a 6 facce, realizzabile in qualsiasi altezza.

Decorazioni con lance e gigli fiorentini.

Possono essere apportate delle modifiche per ottimizzare l'aspetto estetico.

TYPICAL MEDIEVAL STYLE GARDEN LAMP POST  
HEXAGONAL LAMP WITH SPEAR HEADS AND FLORENTINE LILY DECORATION.  
BESPOKE POLE HEIGHT ON REQUEST.  
MODIFICATIONS CAN BE MADE TO IMPROVE THE LOOK.

A - Vetri di tipo trasparenti - CLEAR GLASS

B - Vetri di tipo antincato - FROSTED GLASS

basamento cementato a terra  
ON GROUND CEMENTED BASE

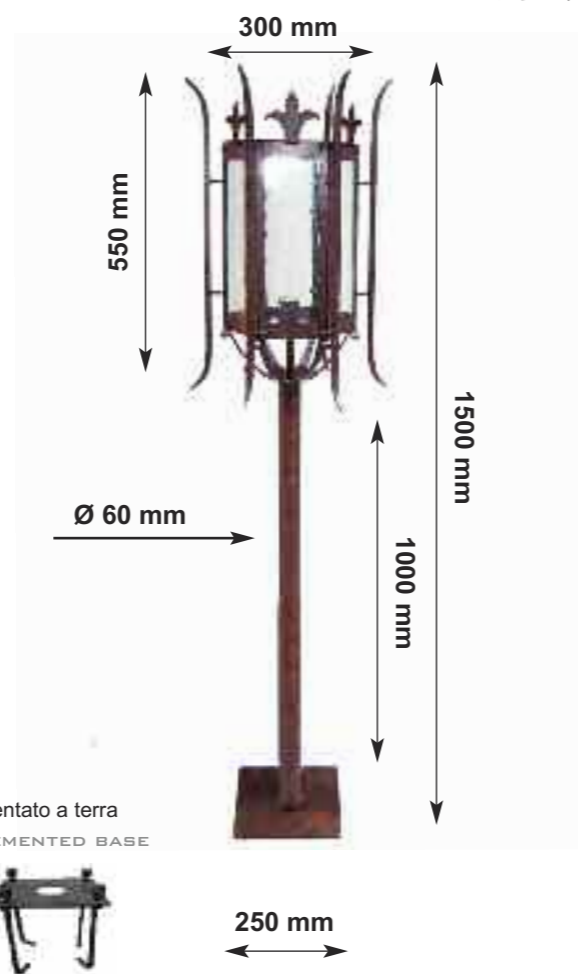

IP 23   
max 60 W E 27  
230 V 50 Hz

## Art. 5576

Lampione

GARDEN LAMP POST

Tipico lampione da giardino in stile medievale a 6 facce, realizzabile in qualsiasi altezza.

Decorazioni con lance e gigli fiorentini.

Possono essere apportate delle modifiche per ottimizzare l'aspetto estetico.

TYPICAL MEDIEVAL STYLE GARDEN LAMP POST  
HEXAGONAL LAMP WITH SPEAR HEADS AND FLORENTINE LILY DECORATION.  
BESPOKE POLE HEIGHT ON REQUEST.  
MODIFICATIONS CAN BE MADE TO IMPROVE THE LOOK.

A - Vetri di tipo trasparenti - CLEAR GLASS

B - Vetri di tipo antincato - FROSTED GLASS

basamento cementato a terra  
ON GROUND CEMENTED BASE

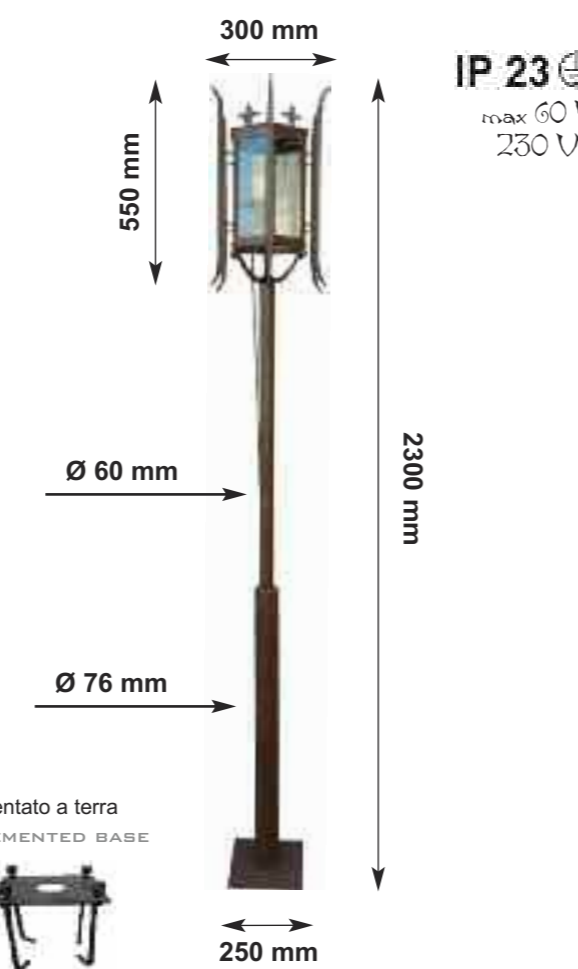

IP 23   
max 60 W E 27  
230 V 50 Hz



Since 1943 Love for Tradition



# Art. 5577

Lampione da giardino

GARDEN LAMP POST

Tipico lampione da giardino in stile Medievale a 6 facce, realizzabile in qualsiasi altezza. Decorazione con gigli fiorentini. Possono essere apportate delle modifiche per ottimizzare l'aspetto estetico.

TYPICAL MEDIEVAL STYLE GARDEN LAMP POST  
HEXAGONAL LAMP WITH FLORENTINE LILY DECORATION.  
BESPOKE POLE HEIGHT ON REQUEST.  
MODIFICATIONS CAN BE MADE TO IMPROVE THE LOOK.

- A - Vetri di tipo trasparenti - CLEAR GLASS
- B - Vetri di tipo anticato - FROSTED GLASS



# Art. 5578

Lampione da giardino

GARDEN LAMP POST

Tipico lampione da giardino in stile Medievale a 6 facce, realizzabile in qualsiasi altezza. Decorazione con gigli fiorentini. Possono essere apportate delle modifiche per ottimizzare l'aspetto estetico.

TYPICAL MEDIEVAL STYLE GARDEN LAMP POST  
HEXAGONAL LAMP WITH FLORENTINE LILY DECORATION.  
BESPOKE POLE HEIGHT ON REQUEST.  
MODIFICATIONS CAN BE MADE TO IMPROVE THE LOOK.

- A - Vetri di tipo trasparenti - CLEAR GLASS
- B - Vetri di tipo anticato - FROSTED GLASS

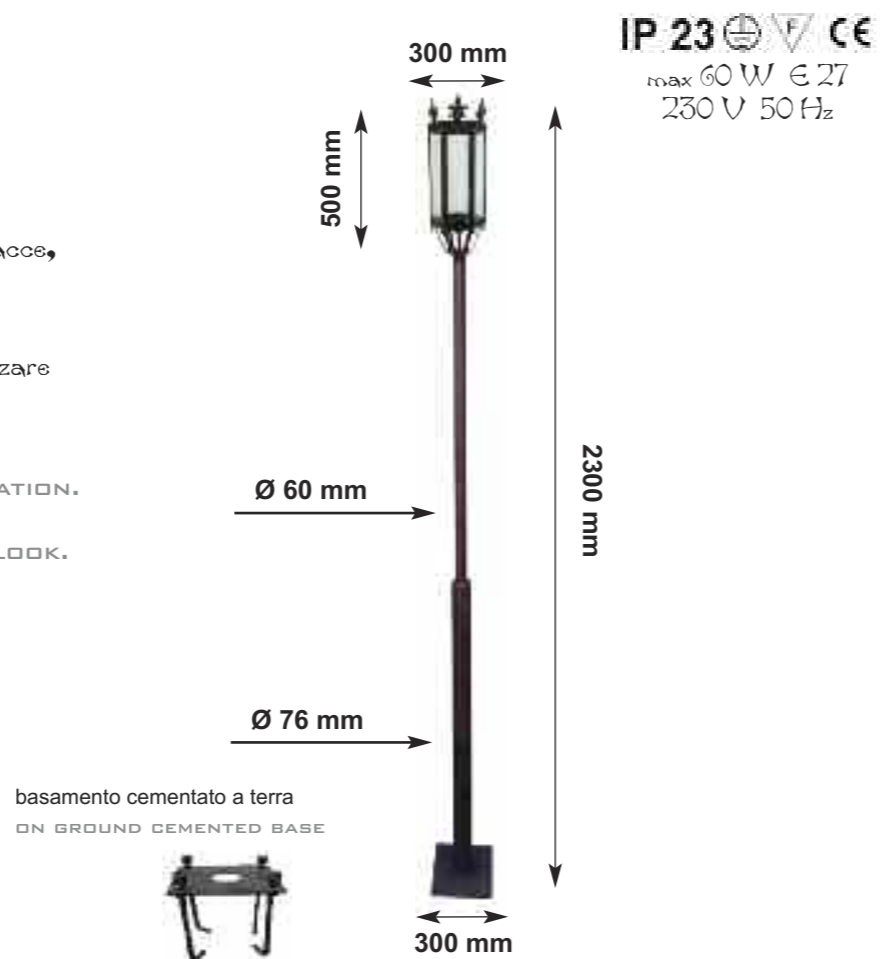

# Art. 7031

Lampione per arredo urbano

LAMP POST FOR STREET FURNITURE

Lampione ad un braccio con lampada esagonale e decorazione medioevale con chiodi forgiati.

SINGLE ARM LAMP POST, EXAGONAL LAMP WITH MEDIEVAL DECORATION AND FORGED NAILS.

basamento cementato a terra  
ON GROUND CEMENTED BASE

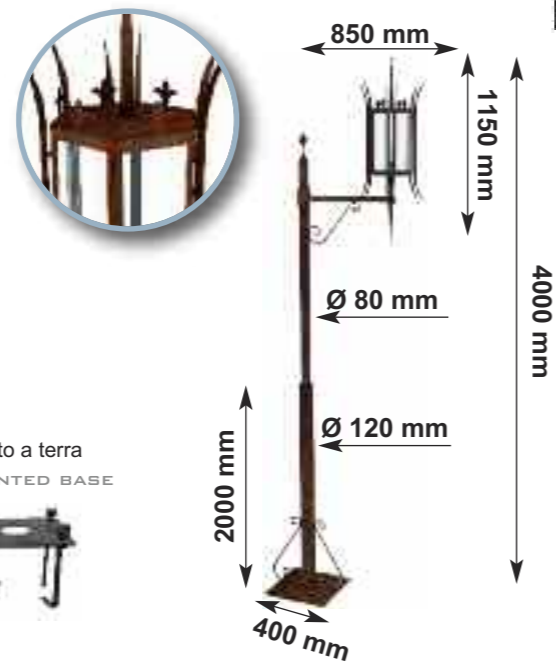

IP 23   
 max 20-100 W E27   
 230 V 50 Hz



# Art. 7032

Lampione per arredo urbano

LAMP POST FOR STREET FURNITURE

Lampione a due bracci con lampada esagonale e decorazione medioevale con chiodi forgiati.

TWO ARM LAMP POST, EXAGONAL LAMP WITH MEDIEVAL DECORATION AND FORGED NAILS.

basamento cementato a terra  
ON GROUND CEMENTED BASE

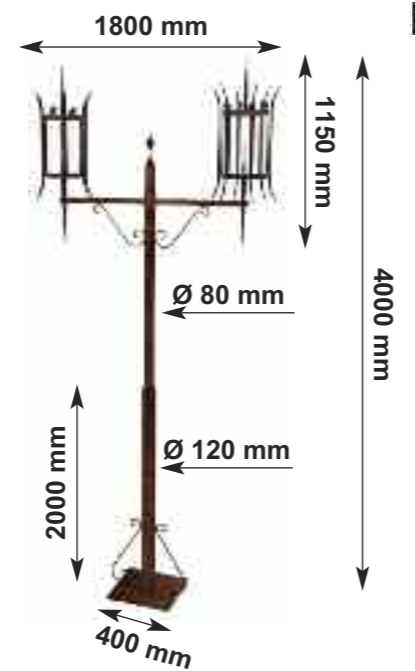

IP 23   
 max 20-100 W   
 x 2 E27   
 230 V 50 Hz



# Art. 7033

Lampione per arredo urbano

LAMP POST FOR STREET FURNITURE

Lampione a tre bracci con lampada esagonale e decorazione medioevale con chiodi forgiati.

THREE ARM LAMP POST, EXAGONAL LAMP WITH MEDIEVAL DECORATION AND FORGED NAILS.

basamento cementato a terra  
ON GROUND CEMENTED BASE

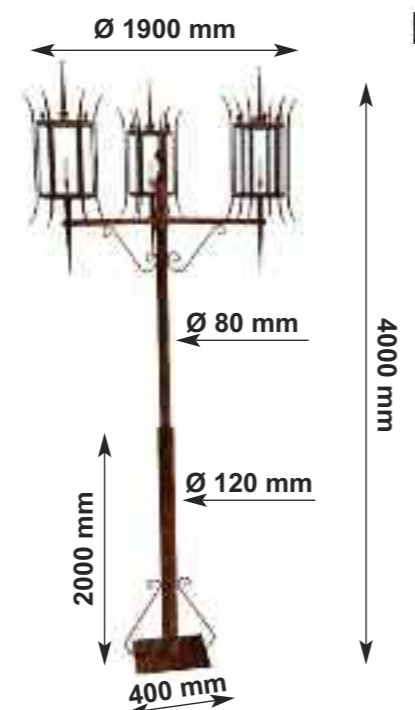

IP 23   
 max 20-100 W   
 x 3 E27   
 230 V 50 Hz



### Art. 5565

Applique a parete

WALL LIGHT

Lampada in stile medievale da interno.  
Trasformabile in porta cero.

MEDIEVAL STYLE TWIN LIGHT FOR INTERIORS.  
ON REQUEST IT CAN BE TURNED INTO A  
SCONCE.

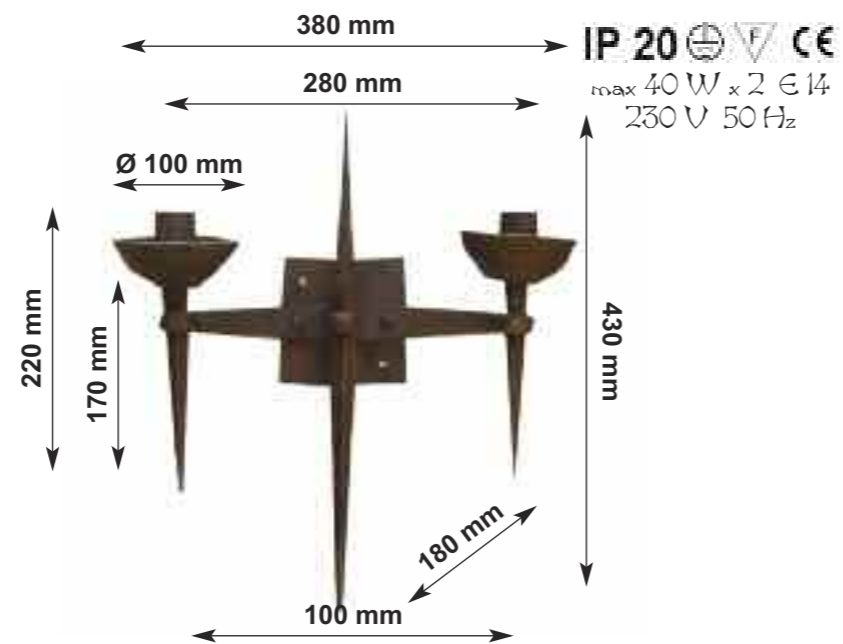

IP 20   
max 40 W x 2 E 14  
230 V 50 Hz

### Art. 5570

Applique a parete

WALL LIGHT

Lampada in stile medievale da interno.  
Trasformabile in porta cero.

MEDIEVAL STYLE TWIN LIGHT FOR INTERIORS.  
ON REQUEST IT CAN BE TURNED INTO A  
SCONCE.

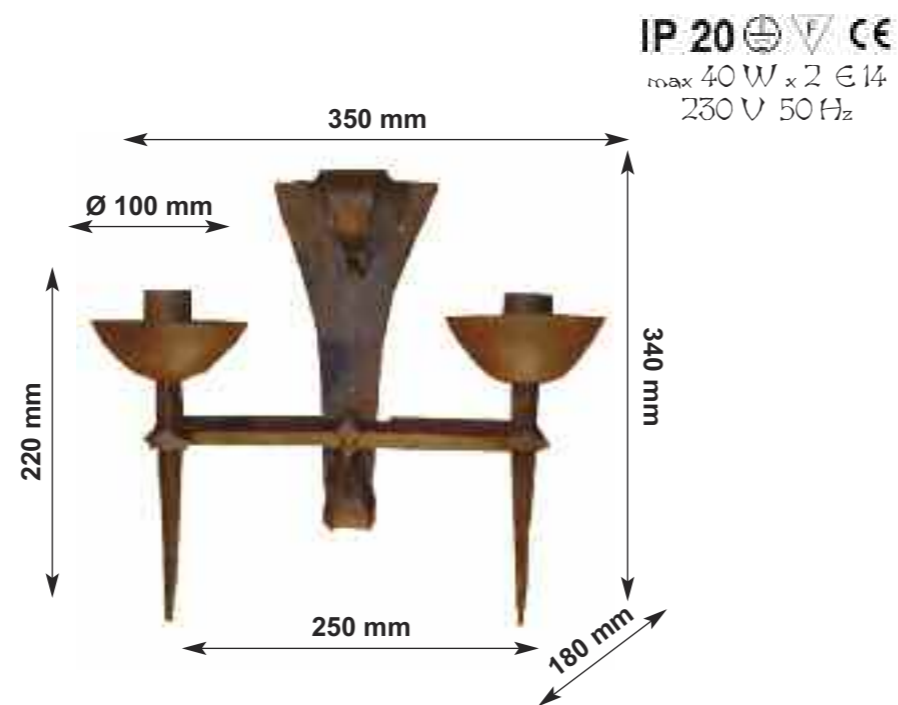

IP 20   
max 40 W x 2 E 14  
230 V 50 Hz

### Art. 5720

Applique a parete

WALL LIGHT

Lampada in stile francescano per uso interno.  
Trasformabile in porta cero.

FRANCISCAN STYLE WALL LIGHT FOR INTERIORS.  
ON REQUEST IT CAN BE TURNED INTO A  
SCONCE.



IP 20   
max 40 W x 3 E 14  
230 V 50 Hz

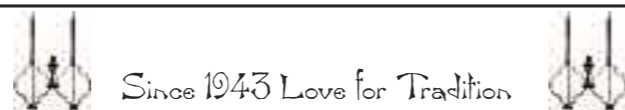

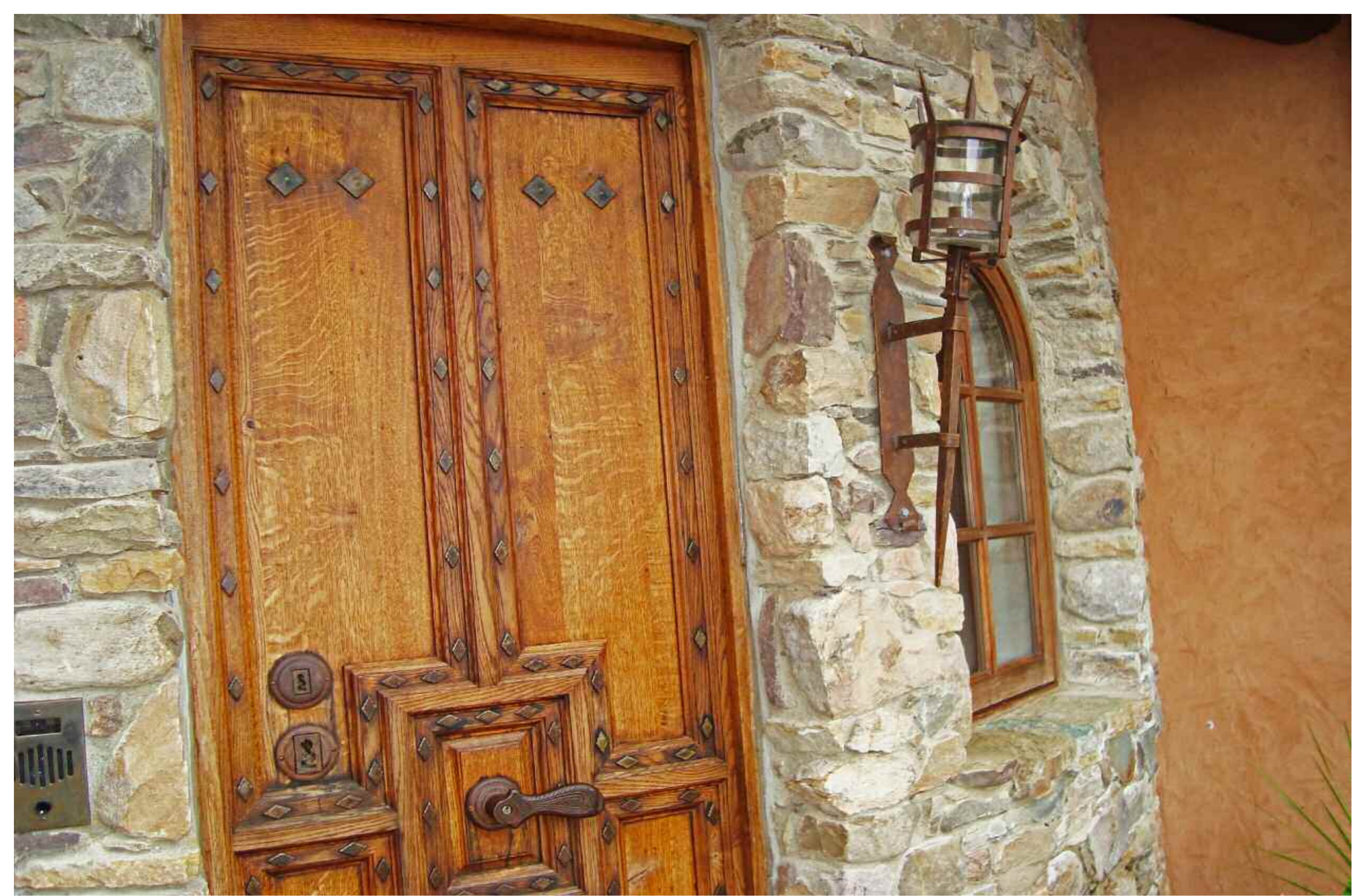

## Art. 5735

Applique  
WALL LIGHT

Lampada in stile medievale di grandi dimensioni per uso esterno.

MEDIEVAL STYLE LAMP, BIG SIZE FOR OUTDOOR, WITH WALL BRACKETS.

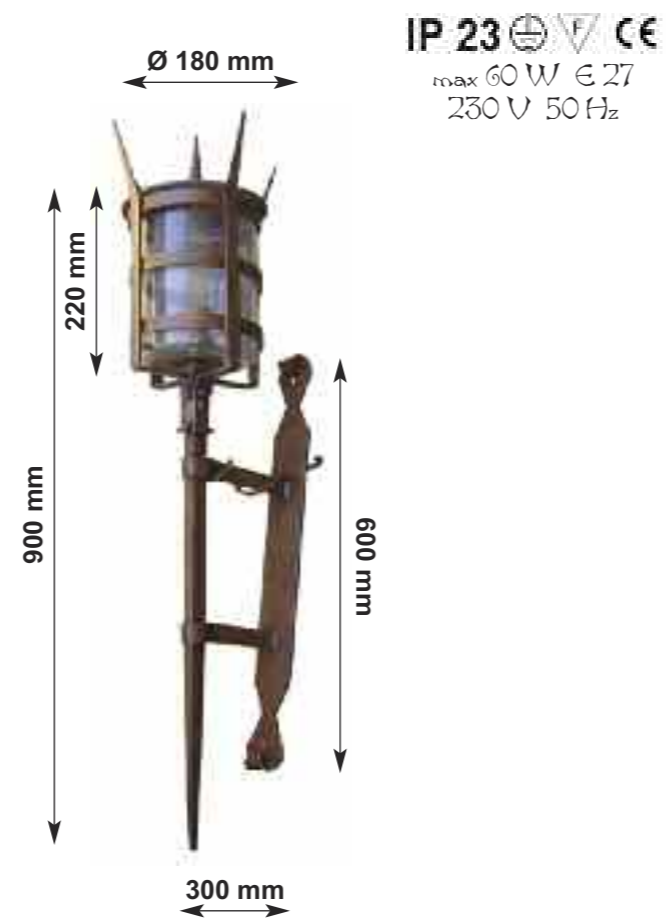

IP 23   
max 60 W  $\epsilon 27$    
230 V 50 Hz

## Art. 5736

Applique  
WALL LIGHT

Lampada in stile medievale di grandi dimensioni per uso esterno, con supporto a spigolo.

MEDIEVAL STYLE LAMP, BIG SIZE FOR OUTDOOR, WITH EDGE BRACKETS.

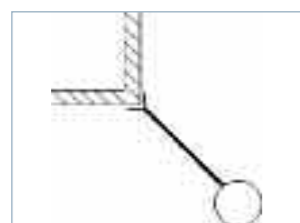

IP 23   
max 60 W  $\epsilon 27$    
230 V 50 Hz



# Art. 5730

Applique  
WALL LIGHT

Lampada in stile medievale di grandi dimensioni per uso interno e porticati. Trasformabile in portacero.

MEDIEVAL STYLE TORCH WITH WALL BRACKETS, BIG SIZE FOR INTERIORS AND PORCH. ON REQUEST IT CAN BE TURNED INTO A CANDLE HOLDER.

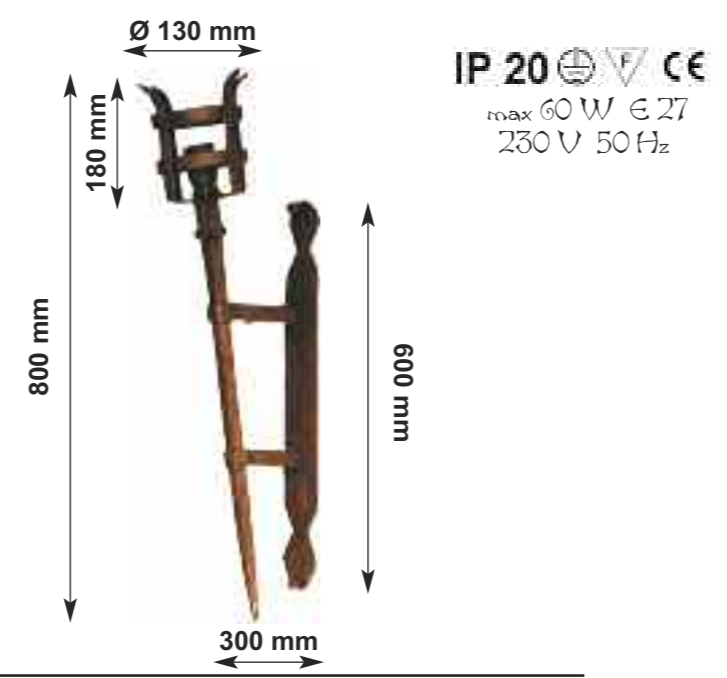

# Art. 5731

Applique  
WALL LIGHT

Lampada in stile medievale di grandi dimensioni per uso interno e porticati. Trasformabile in portacero.

MEDIEVAL STYLE TORCH WITH WALL BRACKETS, BIG SIZE FOR INTERIORS AND PORCH. ON REQUEST IT CAN BE TURNED INTO A CANDLE HOLDER.

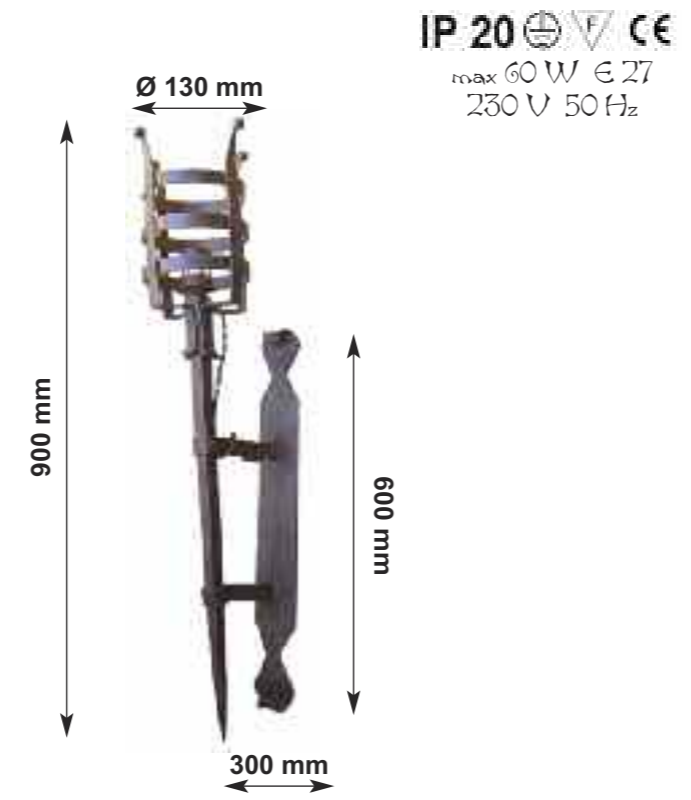

# Art. 5732

Applique  
WALL LIGHT

Lampada in stile medievale di medie dimensioni per uso interno e porticati. Trasformabile in portacero.

MEDIEVAL STYLE TORCH WITH WALL BRACKETS, MEDIUM SIZE FOR INTERIORS AND PORCH. ON REQUEST IT CAN BE TURNED INTO A CANDLE HOLDER.







### Art. 5586

Applique a parete  
WALL LIGHT

Lampada in stile medievale per uso esterno con vetro trasparente. Elegante forgiatura artigianale.

MEDIEVAL STYLE GLASS LAMP WITH BRACKETS FOR OUTDOOR. ELEGANT HAND FORGE.

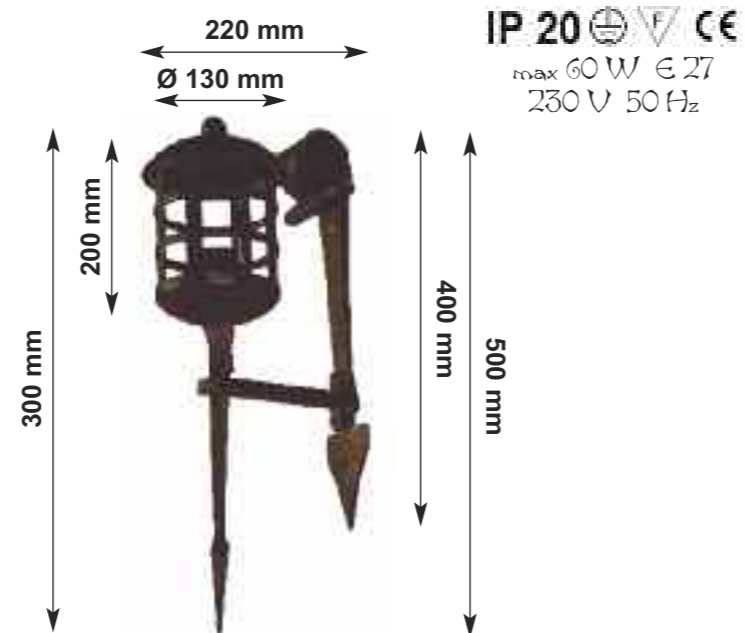

IP 20 CE  
max 60 W E 27  
230 V 50 Hz

### Art. 5585

Applique a parete  
WALL LIGHT

Lampada in stile medievale per uso interno. Elegante forgiatura artigianale. Trasformabile in portacero.

MEDIEVAL STYLE TORCH WITH BRACKETS FOR INTERIORS. ELEGANT HAND FORGE. ON REQUEST IT CAN BE TURNED INTO A CANDLE HOLDER.



IP 20 CE  
max 60 W E 27  
230 V 50 Hz

### Art. 5587

Applique a parete  
WALL LIGHT

Lampada in stile medievale per uso esterno con vetro trasparente. Elegante forgiatura artigianale.

MEDIEVAL STYLE GLASS HANGING LANTERN WITH BRACKETS FOR OUTDOOR. ELEGANT HAND FORGE.

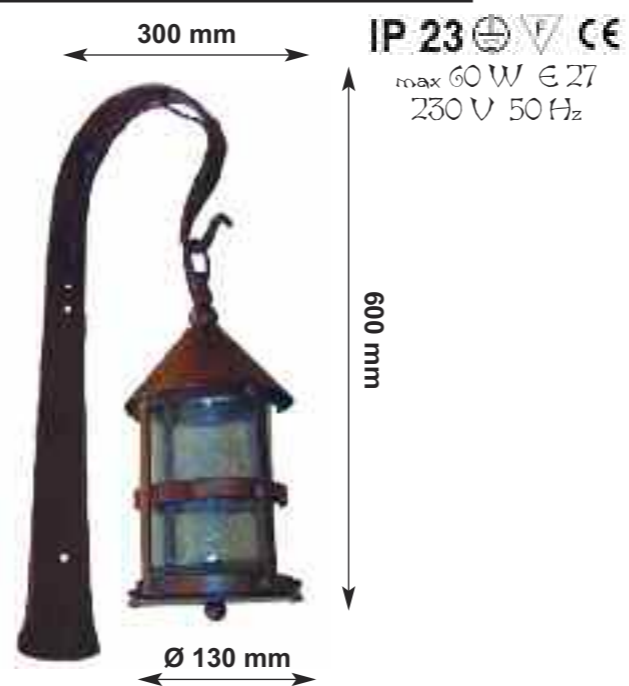

IP 23 CE  
max 60 W E 27  
230 V 50 Hz





## Art. 5595

Applique a parete  
WALL LIGHT

Lampada in stile medievale per uso interno.  
Elegante forgiatura artigianale.  
Trasformabile in portacero.

MEDIEVAL STYLE LAMP FOR INTERIORS.  
ELEGANT HAND FORGE.  
ON REQUEST IT CAN BE TURNED INTO A CANDLE  
HOLDER.

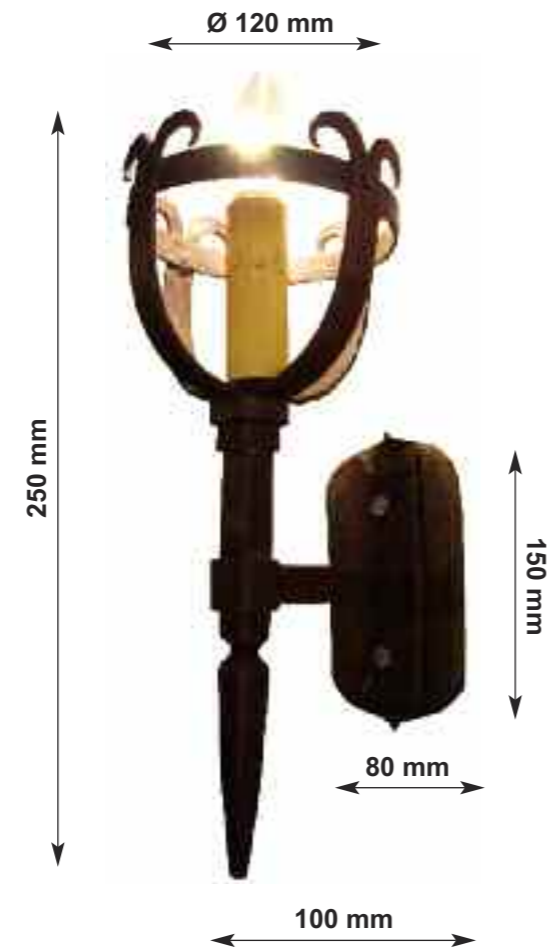

IP 20   
max 40 W  $\epsilon$  14  
230 V 50 Hz



## Art. 5598

Applique a parete  
WALL LIGHT

Lampada in stile medievale per uso interno.  
Elegante forgiatura artigianale.  
Trasformabile in porta candele.

MEDIEVAL STYLE LAMP FOR INTERIORS.  
ELEGANT HAND FORGE.  
ON REQUEST IT CAN BE TURNED INTO A  
SCONCE.



IP 20   
max 40 W x 4  $\epsilon$  14  
230 V 50 Hz



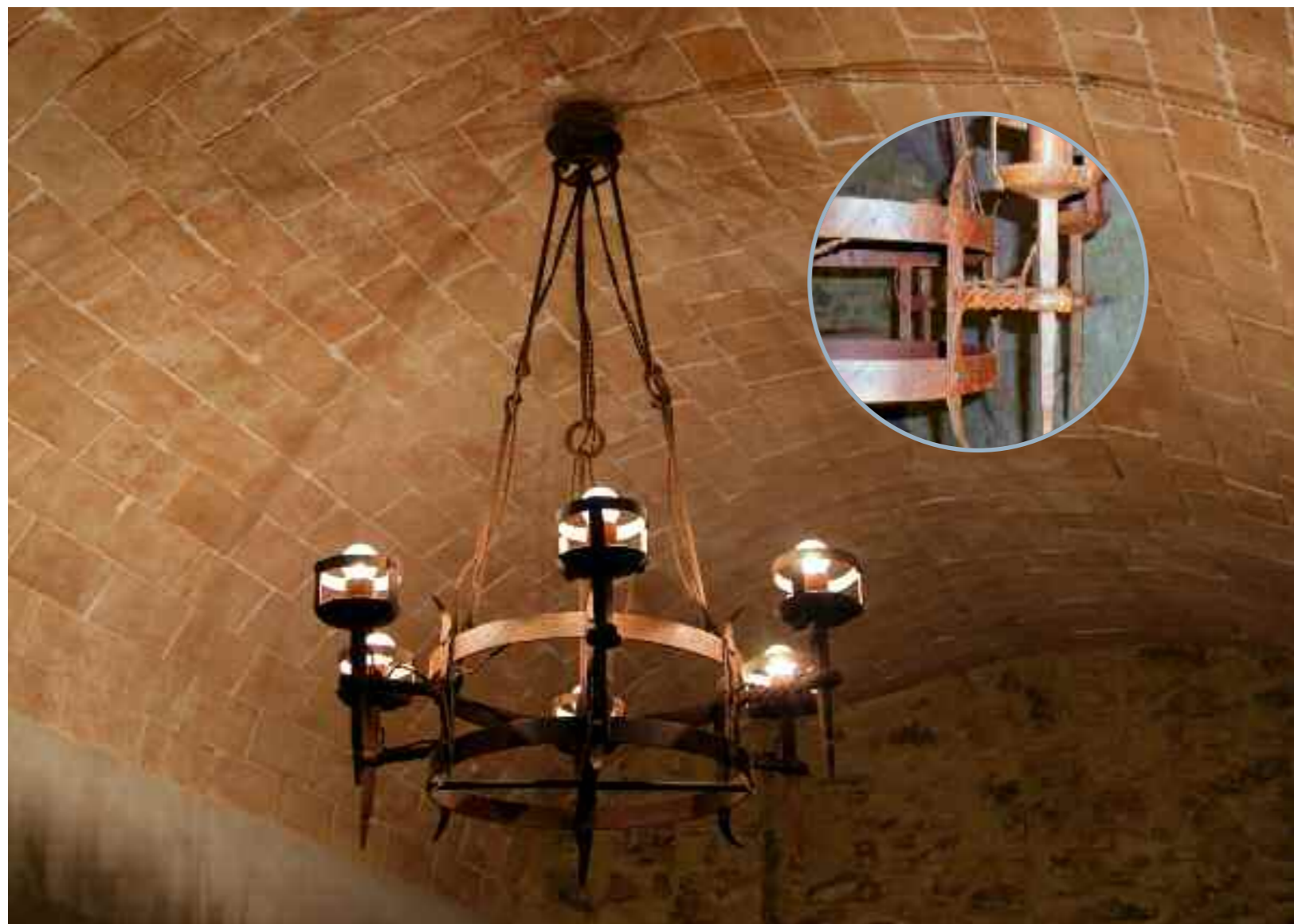

### Art. 5588

Lampadario Medievale  
MEDIÉVAL CHANDELIER

IP 20   
max 60 W x 6 E 27  
230 V 50 Hz

Tipico lampadario in stile Medioevale a 6 luci completamente forgiato a mano con decorazioni ad intarsio sulle fasce di collegamento. L'altezza dal soffitto è realizzata su misura in base alle esigenze.

TYPICAL MEDIEVAL STYLE SIX LIGHT CHANDELIER, TOTALLY HAND FORGED WITH INLAID DECORATIONS.  
ON REQUEST THE HEIGHT FROM CEILING CAN BE MODIFIED.

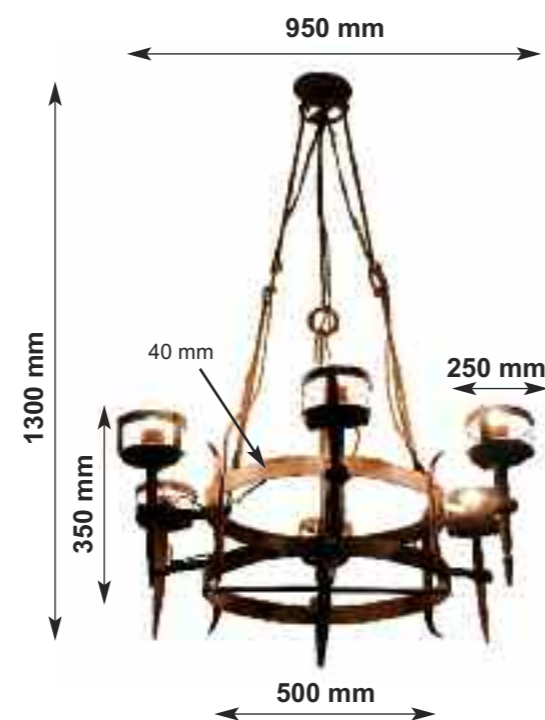

### Art. 5589

Lampadario Medievale  
MEDIÉVAL CHANDELIER

IP 20   
max 60 W x 8 E 27  
230 V 50 Hz

Tipico lampadario in stile Medioevale a 10 luci completamente forgiato a mano con decorazioni ad intarsio sulle fasce di collegamento. L'altezza dal soffitto è realizzata su misura in base alle esigenze.

TYPICAL MEDIEVAL STYLE SIX LIGHT CHANDELIER, TOTALLY HAND FORGED WITH INLAID DECORATIONS.  
ON REQUEST THE HEIGHT FROM CEILING CAN BE MODIFIED.

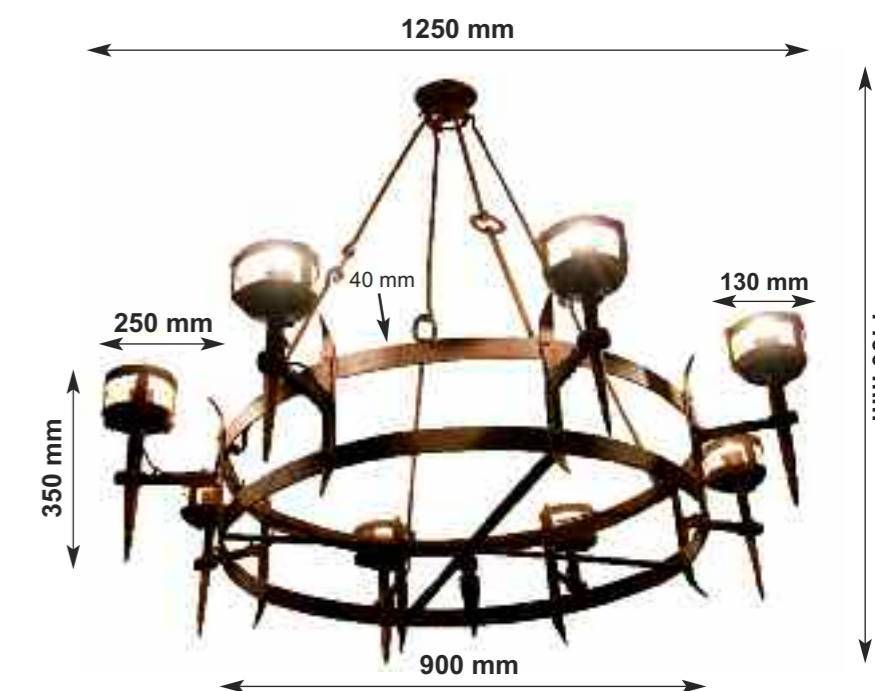



# Art. 5160

## Lampadario Medievale

MEDIEVAL CHANDELIER

Lampadario in stile medievale con 4 luci di elevata qualità. Interamente forgiato a mano.

L'altezza si può avere su misura tramite la maglia di congiunzione art. 5169.

Possibilità di applicare le luci rivolte verso il basso.

Trasformabile in candeliere.

Kg. 60 ca.

MEDIEVAL STYLE FOUR LIGHT CHANDELIER EXCELLENT QUALITY, TOTALLY HAND FORGED.

BESPOKE HEIGHT ON REQUEST BY MEANS OF JOINING LINKS.

THE LIGHTS CAN BE TURNED DOWNWARDS.

AS AN ALTERNATIVE IT CAN BE ADAPTED TO A CANDLE HOLDER.

IP 20 CE

max 60 W x 4 € 14  
230 V 50 Hz

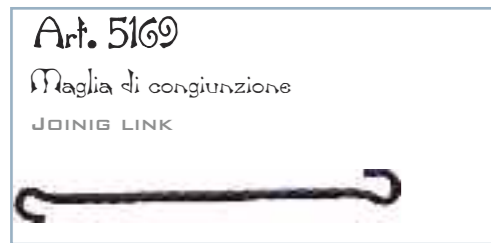

# Art. 5161

## Lampadario Medievale

MEDIEVAL CHANDELIER

Lampadario in stile medievale con 10 luci di elevata qualità. Interamente forgiato a mano.

L'altezza si può avere su misura tramite la maglia di congiunzione art. 5169.

Possibilità di applicare le luci rivolte verso il basso.

Trasformabile in candeliere.

Kg. 60 ca.

MEDIEVAL STYLE TEN LIGHT CHANDELIER EXCELLENT QUALITY, TOTALLY HAND FORGED.

BESPOKE HEIGHT ON REQUEST BY MEANS OF JOINING LINKS.

THE LIGHTS CAN BE TURNED DOWNWARDS.

AS AN ALTERNATIVE IT CAN BE ADAPTED TO A CANDLE HOLDER.

IP 20 CE

max 60 W x 10 € 14  
230 V 50 Hz



# Art. 5162

## Lampadario Medievale

WALL LIGHT

Lampadario in stile medievale con 10 luci di elevata qualità. Interamente forgiato a mano. L'altezza si può avere su misura tramite la maglia di congiunzione art. 5169. Possibilità di applicare le luci rivolte verso il basso e anche all'interno dei cerchi. Trasformabile in candeliere. Kg. 150 ca.

MEDIEVAL STYLE TEN LIGHT CHANDELIER EXCELLENT QUALITY, TOTALLY HAND FORGED. BESPOKE HEIGHT ON REQUEST BY MEANS OF JOINING LINKS. THE LIGHTS CAN BE TURNED DOWNWARDS. AS AN ALTERNATIVE IT CAN BE ADAPTED TO A CANDLE HOLDER. WITH CROWN DECORATION AT THE BOTTOM.



IP 20 CE  
max 60 W x 10 € 14  
230 V 50 Hz

2700 mm

1400 mm

Art. 5169  
Maglia di congiunzione  
JOINIG LINK

# Art. 5163

## Lampadario Medievale

WALL LIGHT

Lampadario in stile medievale con 18 luci di elevata qualità. Interamente forgiato a mano. L'altezza si può avere su misura tramite la maglia di congiunzione art. 5169. Possibilità di applicare le luci rivolte verso il basso e anche all'interno dei cerchi. Trasformabile in candeliere. Kg. 220 ca.

MEDIEVAL STYLE EIGHTEEN LIGHT CHANDELIER EXCELLENT QUALITY, TOTALLY HAND FORGED. BESPOKE HEIGHT ON REQUEST BY MEANS OF JOINING LINKS. THE LIGHTS CAN BE TURNED DOWNWARDS. AS AN ALTERNATIVE IT CAN BE ADAPTED TO A CANDLE HOLDER. WITH CROWN DECORATION AT THE BOTTOM.



IP 20 CE  
max 60 W x 18 € 14  
230 V 50 Hz

2900 mm

2100 mm

Art. 5169  
Maglia di congiunzione  
JOINIG LINK





# Art. 5580

Applique a parete  
WALL LIGHT

Lampada alogena in stile Rustico con paralume inclinabile specifica, da esterno per insegne o simili. La lampada può essere montata verso l'alto.

COUNTRY LIFE STYLE HALOGEN LAMP FOR OUTDOOR SWIVELING LAMP FOR SIGNS AND THE LIKE. THE LAMP CAN BE PLACED UPWARDS.

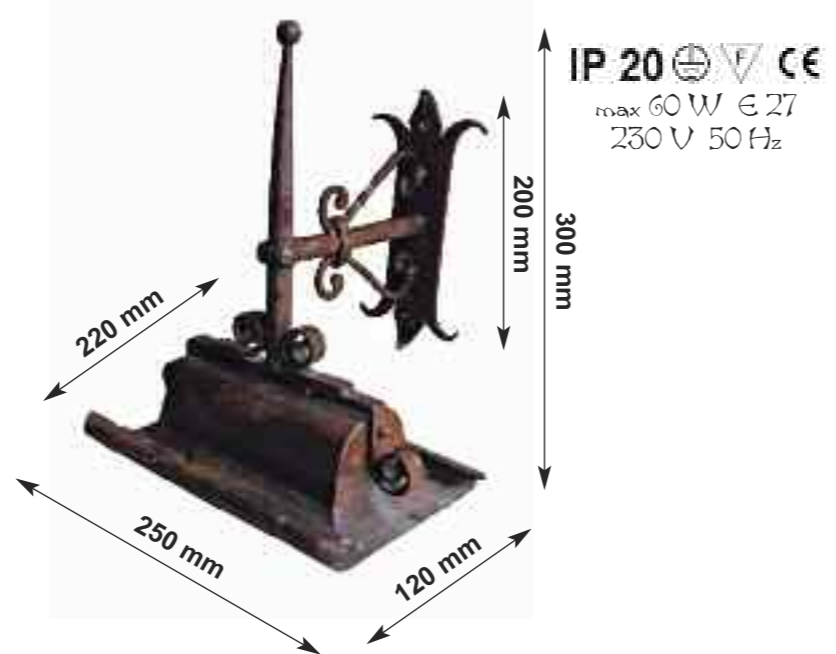

# Art. 5765

Appliques a parete  
WALL LIGHT

Lampada in stile medievale di medie dimensioni per uso interno e porticati. La lampada può essere montata verso l'alto.

MEDIEVAL STYLE LAMP MEDIUM SIZE FOR INTERIORS AND PORCH. THE LAMP CAN BE PLACED UPWARDS.

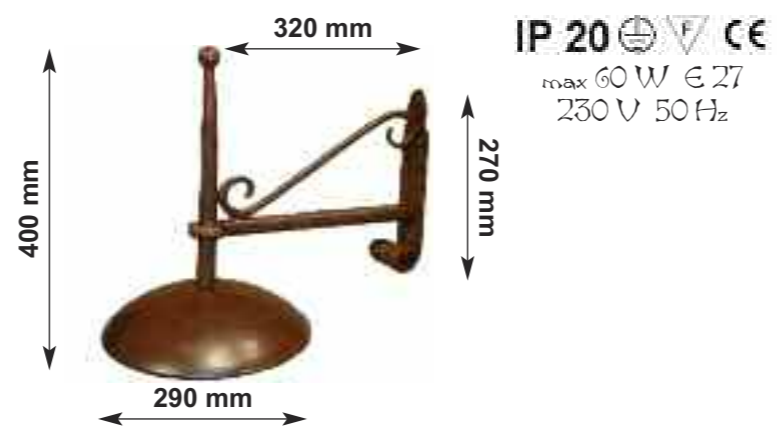

# Art. 5760

Appliques a parete  
WALL LIGHT

Lampada in stile medievale di medie dimensioni per uso interno e porticati. Trasformabile in portacero, la lampada può essere montata verso l'alto.

MEDIEVAL STYLE LAMP MEDIUM SIZE FOR INTERIORS AND PORCH. ON REQUEST IT CAN BE TURNED INTO A CANDLE HOLDER, THE LAMP CAN BE PLACED UPWARDS.



**Art. 5761**  
Appliques a parete per angolo  
WALL LIGHT WITH CORNER BRACKETS

**Art. 5762**  
Appliques a parete per spigolo  
WALL LIGHT WITH EDGE BRACKETS



# Art. 5582

Lampione per arredo urbano  
LAMP POST FOR STREET FURNITURE

Lampione da terra di grandi dimensioni in stile classico,  
ad una luce.  
Realizzabile in qualsiasi altezza.

CLASSIC STYLE SINGLE LIGHT LAMP POST, BIG SIZE.  
BESPOKE POLE HEIGHT ON REQUEST.

IP 23   
max 40-100 W E 40  
230 V 50 Hz

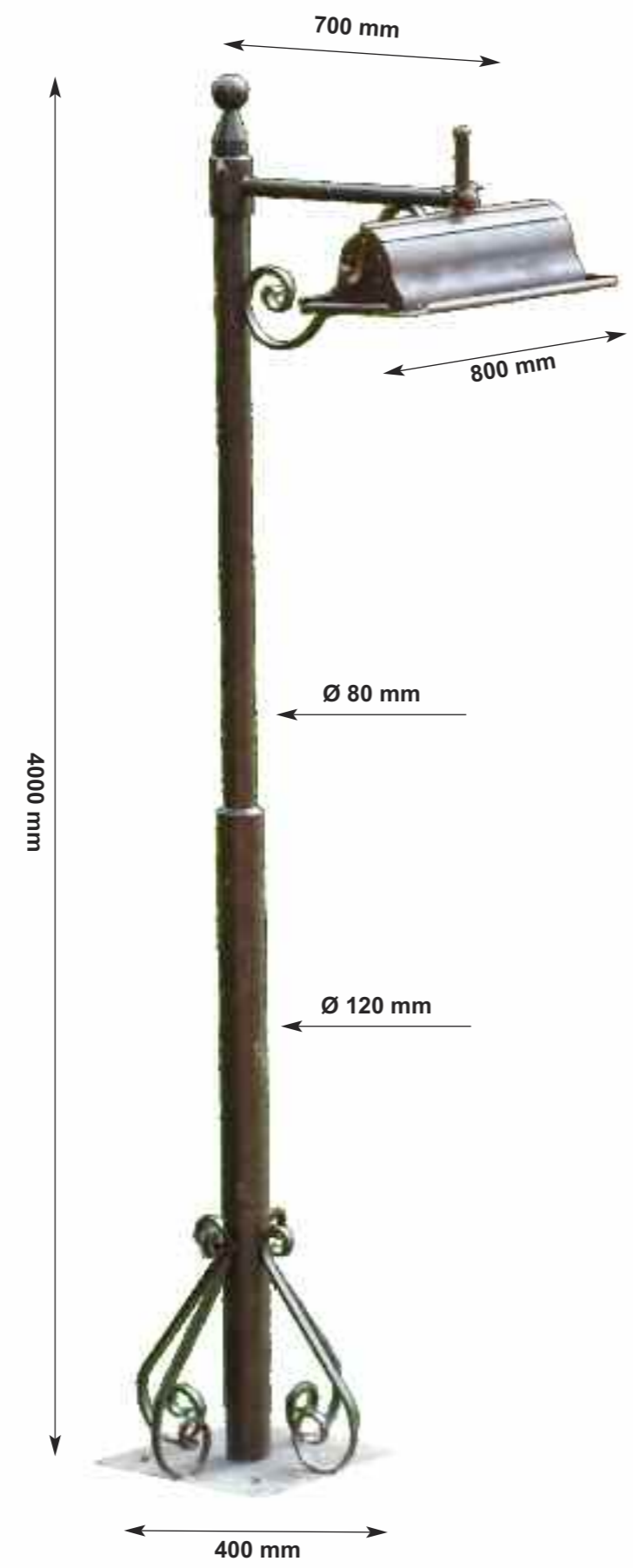

basamento cementato a terra  
ON GROUND CEMENTED BASE



## Art. 5190

Lampadario  
CEILING PENDANT LIGHT

Lampada sospensione a tre luci in stile fiorentino epoca primi '900.  
Elegante forgiatura a coltello.

EARLY TWENTIETH CENTURY FLORENTINE STYLE  
THREE LIGHT CHANDELIER.  
ELEGANT HAND FORGE.

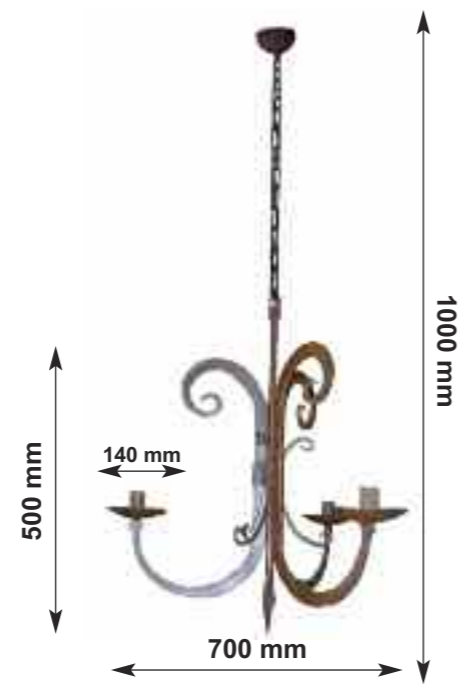

IP 20   
max 60 W x3 E 27  
230 V 50 Hz

## Art. 5650

Applique a due luci  
WALL LIGHT

Lampada in stile fiorentino epoca primi '900.  
Elegante forgiatura a coltello.  
Trasformabile in portacero.

EARLY TWENTIETH CENTURY FLORENTINE STYLE  
DOUBLE LIGHT LAMP, ELEGANT HAND FORGED.  
ON REQUEST IT CAN BE TURNED INTO A  
SCONCE.

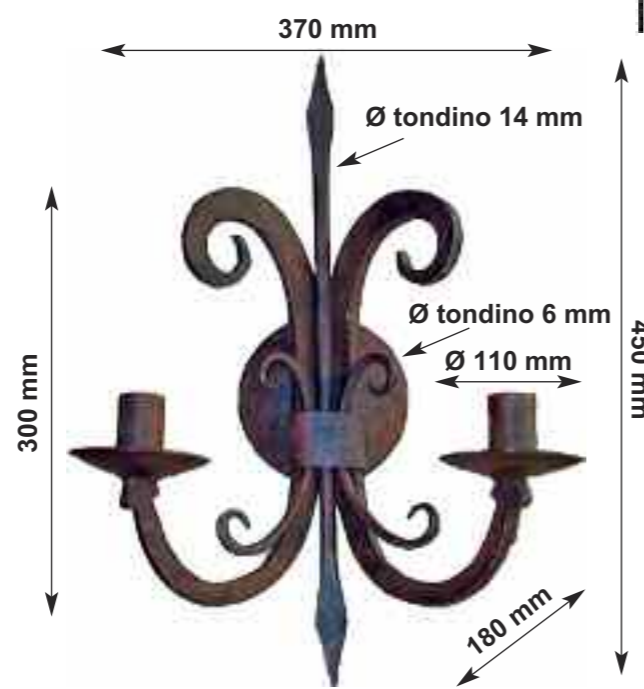

IP 20   
max 40 W x2 E 14  
230 V 50 Hz

## Art. 5651

Variante con ventoline in tessuto.  
OPTION WITH FABRIC LAMPSHADE.

## Art. 5655

Applique a tre luci  
WALL LIGHT

Lampada in stile Fiorentino Epoca primi '900.  
Elegante forgiatura a coltello.  
Trasformabile in portacero.

EARLY TWENTIETH CENTURY FLORENTINE STYLE  
DOUBLE LIGHT LAMP, ELEGANT HAND FORGED.  
ON REQUEST IT CAN BE TURNED INTO A  
SCONCE.

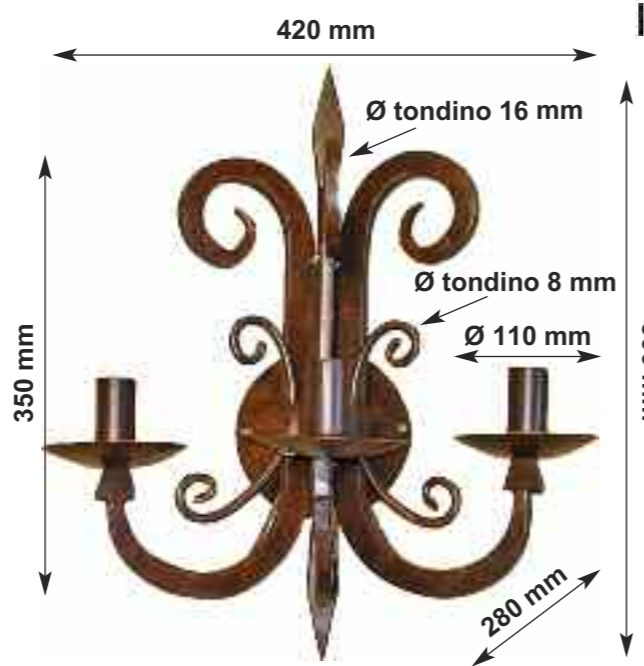

IP 20   
max 40 W x3 E 14  
230 V 50 Hz



## Art. 5180

Lampadario

CEILING PENDANT LIGHT

Lampadario a due luci in stile arte povera. Elegante forgiatura artigianale, con piatto in ferro.

COUNTRY LIFE STYLE CHANDELIER, DOUBLE LIGHT, ELEGANT HAND FORGED WITH IRON PLATE

A- con ceramica bianca liscia  
SMOOTH WHITE CERAMIC

B- con ceramica avorio liscia  
SMOOTH IVORY CERAMIC

C- con ceramica bianca smerlata  
WAVY WHITE CERAMIC

D- con ceramica avorio smerlata  
WAVY IVORY CERAMIC

V- con vetro di Murano art. 9641  
MURAN GLASS ART. 9641

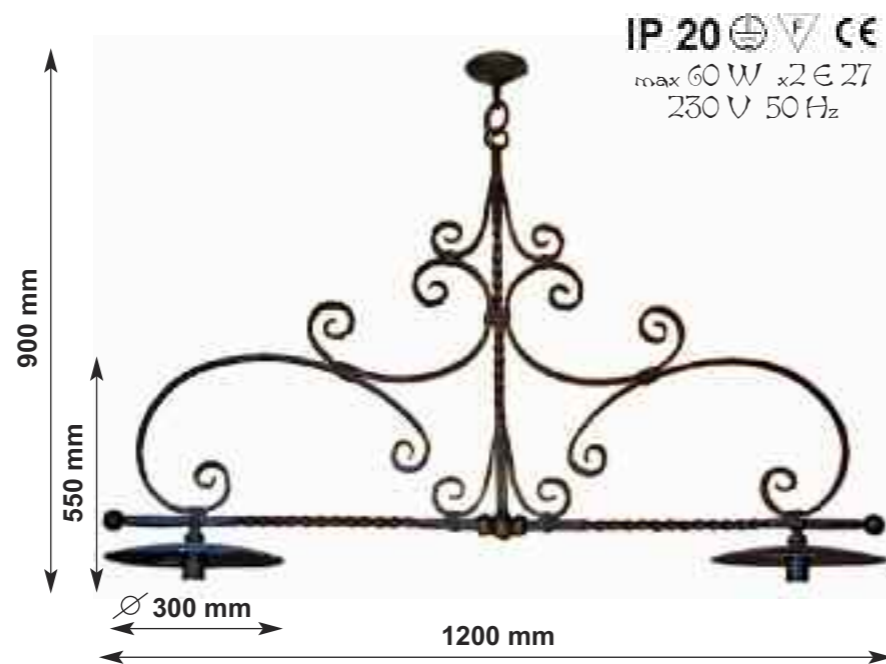

## Art. 5185

Lampadario

CEILING PENDANT LIGHT

Lampadario a tre luci in stile arte povera. Elegante forgiatura artigianale, con piatto in ferro.

COUNTRY LIFE STYLE CHANDELIER, THREE LIGHTS, ELEGANT HAND FORGED WITH IRON PLATE

A- con ceramica bianca liscia  
SMOOTH WHITE CERAMIC

B- con ceramica avorio liscia  
SMOOTH IVORY CERAMIC

C- con ceramica bianca smerlata  
WAVY WHITE CERAMIC

D- con ceramica avorio smerlata  
WAVY IVORY CERAMIC

V- con vetro di Murano art. 9641  
MURAN GLASS ART. 9641

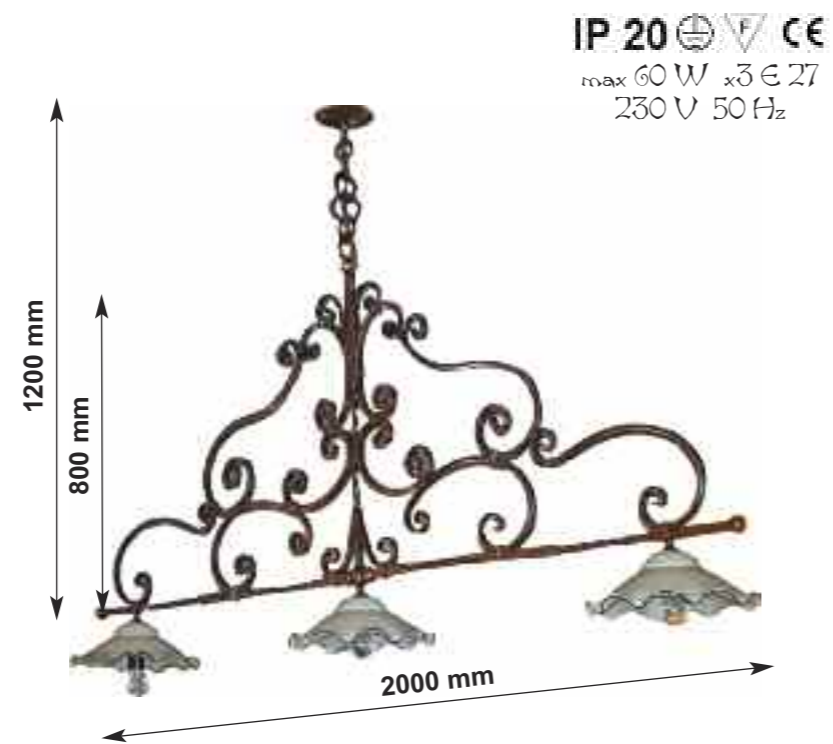

## Art. 5660

Lampada

WALL LIGHT

Lampada a due luci in stile Fiorentino epoca primi '900, di elegante forgiatura. Trasformabile in portacero.

EARLY TWENTIETH CENTURY FLORENTINE STYLE DOUBLE LIGHT LAMP, ELEGANT HAND FORGED. ON REQUEST IT CAN BE TURNED INTO A SCONCE.

## Art. 5661

Variante con ventoline in tessuto.

OPTION WITH FABRIC LAMPSHADE.

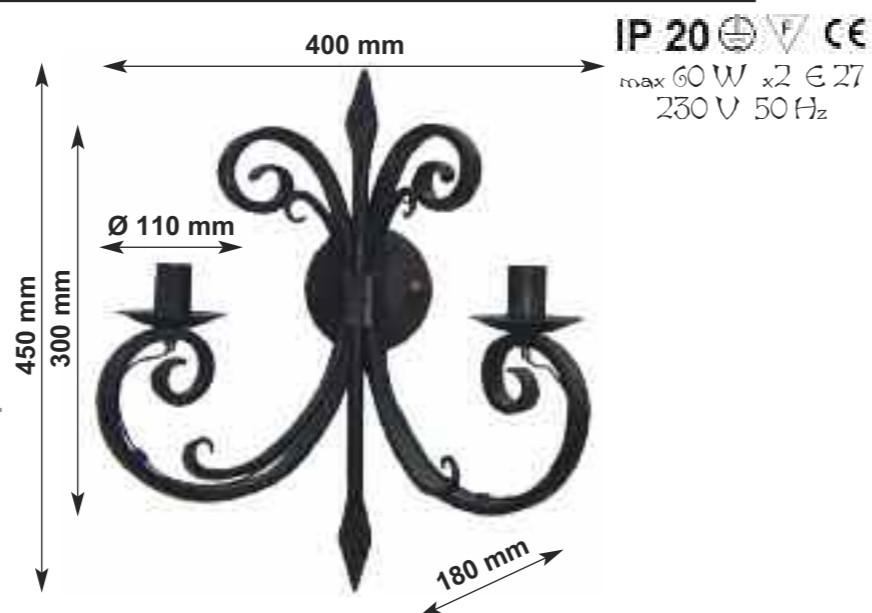

## Art. 5200

Lampione da giardino

GARDEN LAMP POST

Lampioncino da giardino con decorazione della base forgiata a mano e corpo illuminante a quattro facce in vetro.

GARDEN LAMP POST WITH HAND FORGED DECORATION SQUARE GLASS LANTERN.

A - Vetri di tipo trasparenti - CLEAR GLASS

B - Vetri di tipo antincato - FROSTED GLASS

basamento cementato a terra  
ON GROUND CEMENTED BASE



## Art. 5205

Mezzalanterna a parete

WALL LIGHT

Lanterna a tre facce illuminanti in vetro.

GLASS LANTERN, THREE SIDES.

A - Vetri di tipo trasparenti - CLEAR GLASS

B - Vetri di tipo antincato - FROSTED GLASS



Since 1943 Love for Tradition

www.armoniedepoca.com

## Art. 5780

Appliche a parete

WALL LIGHT

Lampada a luce diffusa, in stile tradizionale umbro, realizzata con coppo originale antico.

TRADITIONAL LAMP FROM UMBRIA, UPWARDS AND DIFFUSED LIGHTING.  
MADE WITH ORIGINAL OLD ROOF TILE.

- A - Porta lampada a chiocciola tenuta stagna.  
Specifico da esterno e porticati  
B - Portalampana semplice per uso interno

A - WATERTIGHT LAMPSOCKET FOR OUTDOOR  
AND PORCH.  
B - SIMPLE LAMPSOCKET FOR INTERIORS.

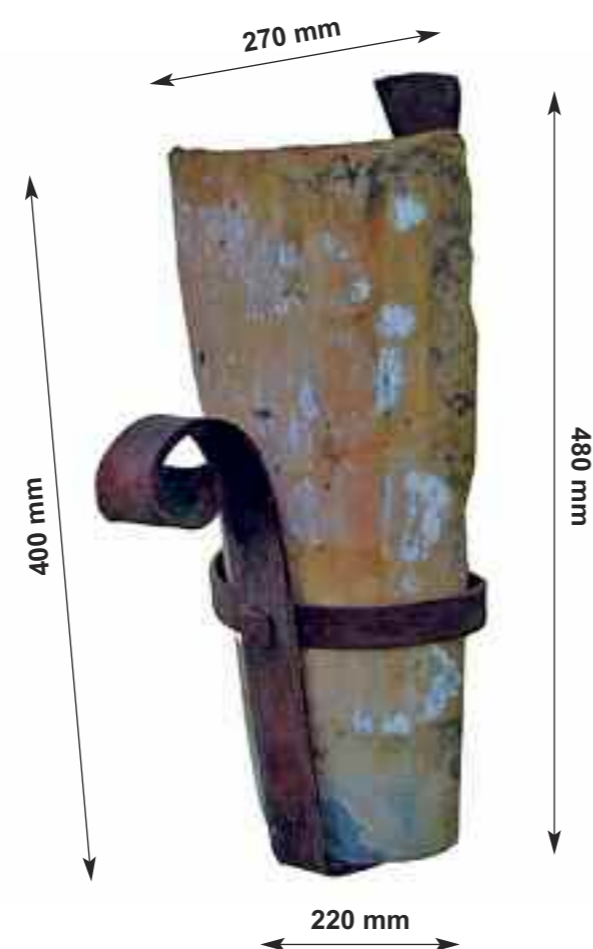

IP 20

max 60 W E 27  
230 V 50 Hz



Since 1943 Love for Tradition



www.armoniedepoca.com

# Art. 5785

Applique a parete

WALL LIGHT

IP 20  CE  
max 60 W X2 E 27  
230 V 50 Hz

Lampada a luce diffusa con due luci, in stile tradizionale umbro, per interni.

Realizzata con coppo originale antico.

TRADITIONAL LAMP FROM UMBRIA, DUAL BULB, INDIRECT AND DIFFUSED LIGHTING, FOR INTERIORS.  
MADE WITH ORIGINAL OLD ROOF TILE.



270 mm



Since 1943 Love for Tradition

www.armoniedepoca.com

## Art. 5790

Applique a parete

WALL LIGHT

Lampada a luce diffusa con vetri, di forma cilindrica con ribattini.

Misura grande, per esterno.

INDIRECT AND DIFFUSED LIGHTING LAMP WITH GLASS, CYLINDRICAL SHAPE WITH RIVETS. BIG SIZE, FOR OUTDOOR.



IP 43   
 max 60 W x 2 E 27   
 230 V 50 Hz

## Art. 5791

Applique a parete

WALL LIGHT

Lampada a luce diffusa con vetri, di forma cilindrica con ribattini.

Misura grande, per esterno e interno

INDIRECT AND DIFFUSED LIGHTING LAMP WITH GLASS, CYLINDRICAL SHAPE WITH RIVETS. SMALL SIZE, FOR OUTDOOR AND INTERIORS.



IP 43   
 max 60 W x 2 E 27   
 230 V 50 Hz

## Art. 5795

Applique a parete

WALL LIGHT

Lampada a mezzo capitello greco, luce diffusa con vetro. Per esterno e interno.

UPWARDS AND DIFFUSED LIGHTING LAMP WITH GLASS, GREEK CAPITAL SHAPE. SMALL SIZE, FOR OUTDOOR AND INTERIORS.

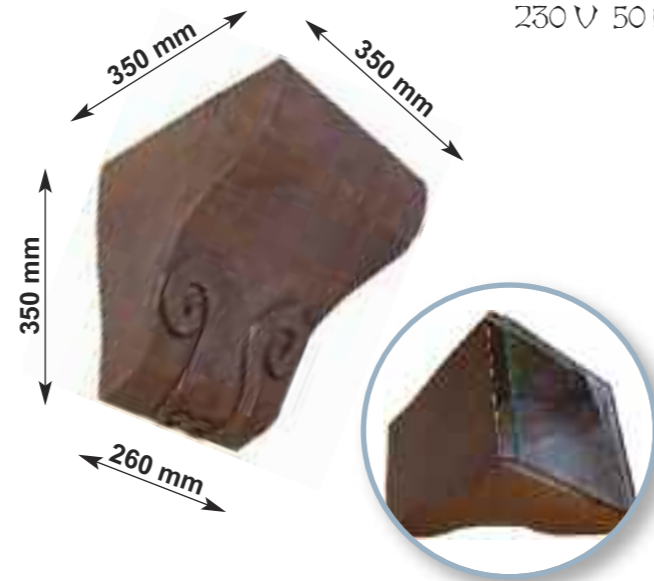

IP 43   
 max 60 W x 3 E 27   
 230 V 50 Hz





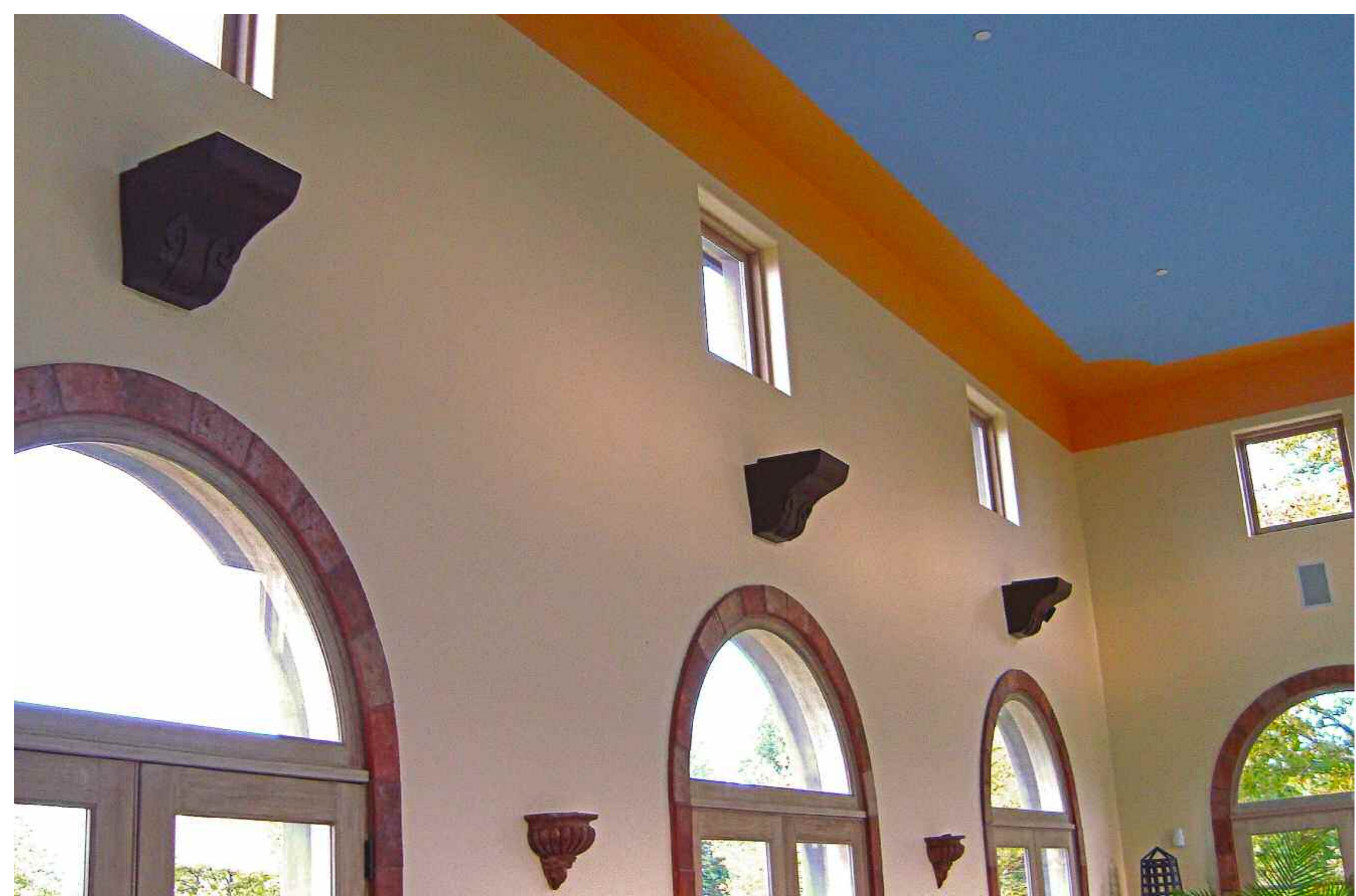

### Art. 5690

Applique a parete

WALL LIGHT

Lampada a luce diffusa, forma di scodella stile rustico, per uso interno.

Porta lampada E27, oppure porta lampada per alogena bulbo 300 W.

COUNTRY LIFE STYLE UPWARDS AND DIFFUSED LIGHTING LAMP, FLAT SHAPE. FOR INTERIORS. E27 LAMP SOCKET, OR 300W HALOGEN BULB LAMP SOCKET.

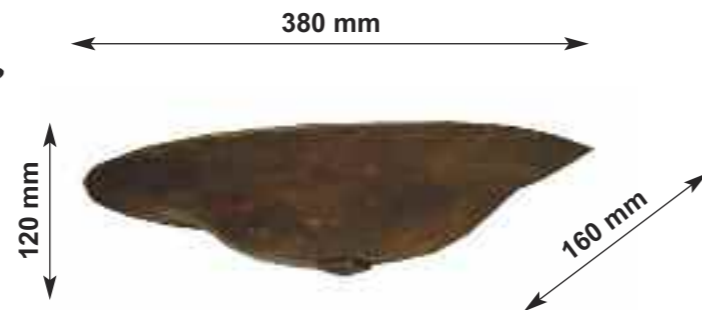

IP 20 CE  
max 60 W E 27  
230 V 50 Hz

### Art. 5691

Applique a parete

WALL LIGHT

Lampada a luce diffusa, forma di scodella stile rustico, per uso interno.

Porta lampada E27, oppure porta lampada per alogena bulbo 300 W.

COUNTRY LIFE STYLE UPWARDS AND DIFFUSED LIGHTING LAMP, FLAT SHAPE. FOR INTERIORS. E27 LAMP SOCKET, OR 300W HALOGEN BULB LAMP SOCKET.



IP 20 CE  
max 60 W E 27  
230 V 50 Hz

### Art. 5692

Applique a parete

WALL LIGHT

Lampada a luce diffusa, forma di scodella stile rustico, per uso interno.

Porta lampada E27, oppure porta lampada per alogena bulbo 300 W.

COUNTRY LIFE STYLE UPWARDS AND DIFFUSED LIGHTING LAMP, FLAT SHAPE. FOR INTERIORS. E27 LAMP SOCKET, OR 300W HALOGEN BULB LAMP SOCKET.

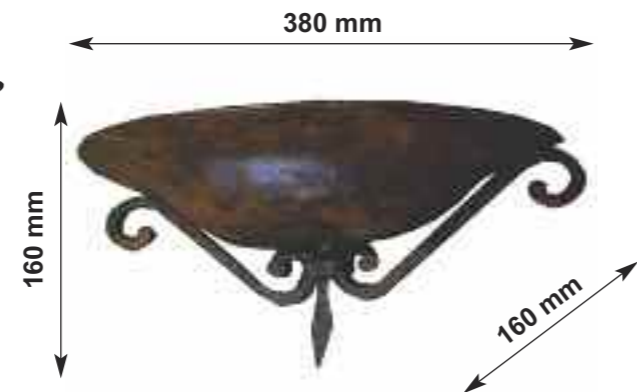

IP 20 CE  
max 60 W E 27  
230 V 50 Hz



# Misura Piccola SMALL SIZE

## Art. 5502

Lanterna a parete  
WALL LANTERN

Tipica lampada in stile rustico di piccole dimensioni da interno o da porticato.

TYPICAL COUNTRY LIFE STYLE LANTERN, SMALL SIZE, FOR INTERIORS AND PORCH.

- A - Vetri di tipo trasparenti - CLEAR GLASS
- B - Vetri di tipo anticondensation - FROSTED GLASS



IP 23   
 max 60 W E 27  
 230 V 50 Hz

## Art. 5500

Lanterna da soffitto  
CEILING PENDANT LANTERN

Tipica lampada in stile rustico di piccole dimensioni da interno o da porticato.

TYPICAL COUNTRY LIFE STYLE LANTERN, SMALL SIZE, FOR INTERIORS AND PORCH.

- A - Vetri di tipo trasparenti - CLEAR GLASS
- B - Vetri di tipo anticondensation - FROSTED GLASS

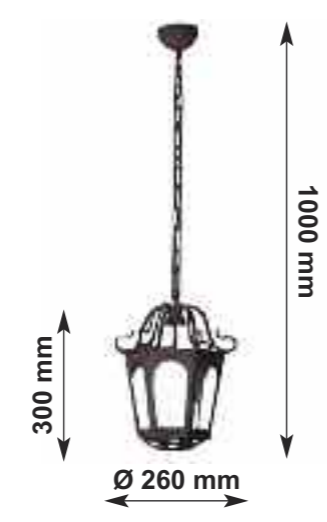

IP 23   
 max 60 W E 27  
 230 V 50 Hz

## Art. 5501

Lanterna a muro  
WALL LANTERN

Tipica lampada con braccio in stile rustico, di piccole dimensioni, da interno o porticato.

TYPICAL COUNTRY LIFE STYLE LANTERN, SMALL SIZE, UP LIGHT WITH WALL BRACKETS, FOR INTERIORS AND PORCH.

- A - Vetri di tipo trasparenti - CLEAR GLASS
- B - Vetri di tipo anticondensation - FROSTED GLASS

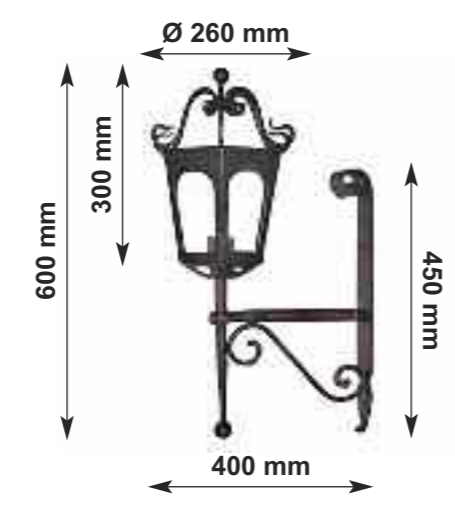

IP 23   
 max 60 W E 27  
 230 V 50 Hz

## Art. 5503

Lanterna a muro  
WALL LANTERN

Tipica lampada pendente in stile rustico di piccole dimensioni da interno o da porticato.

TYPICAL COUNTRY LIFE STYLE HANGING LANTERN, SMALL SIZE, WITH WALL BRACKETS, FOR INTERIORS AND PORCH.

- A - Vetri di tipo trasparenti - CLEAR GLASS
- B - Vetri di tipo anticondensation - FROSTED GLASS



IP 23   
 max 60 W E 27  
 230 V 50 Hz



# Misura Media

## MEDIUM SIZE

### Art. 5507

Lanterna a parete

WALL LANTERN

Tipica lampada in stile rustico di medie dimensioni da interno o da porticato.

TYPICAL COUNTRY LIFE STYLE LANTERN, MEDIUM SIZE.

FOR INTERIORS AND PORCH.

A - Vetri di tipo trasparenti - CLEAR GLASS

B - Vetri di tipo antincato - FROSTED GLASS



IP 23

max 60 W E 27  
230 V 50 Hz

### Art. 5505

Lanterna da soffitto

CEILING PENDANT LANTERN

Tipica lampada in stile rustico di medie dimensioni da interno o da porticato.

TYPICAL COUNTRY LIFE STYLE LANTERN, MEDIUM SIZE.

FOR INTERIORS AND PORCH.

A - Vetri di tipo trasparenti - CLEAR GLASS

B - Vetri di tipo antincato - FROSTED GLASS

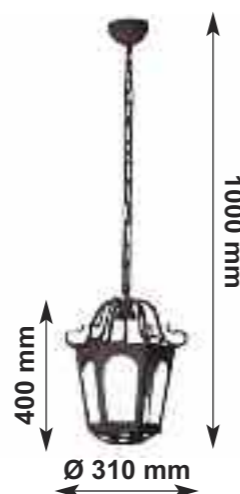

IP 23

max 60 W E 27  
230 V 50 Hz

### Art. 5506

Lanterna a muro

WALL LANTERN

Tipica lampada con braccio in stile rustico, di medie dimensioni, da interno o porticato.

TYPICAL COUNTRY LIFE STYLE LANTERN, MEDIUM SIZE, UP LIGHT WITH WALL BRACKETS. FOR INTERIORS AND PORCH.

A - Vetri di tipo trasparenti - CLEAR GLASS

B - Vetri di tipo antincato - FROSTED GLASS



IP 23

max 60 W E 27  
230 V 50 Hz

### Art. 5508

Lanterna a muro

WALL LANTERN

Tipica lampada pendente in stile rustico di medie dimensioni da interno o da porticato.

TYPICAL COUNTRY LIFE STYLE HANGING LANTERN, MEDIUM SIZE, WITH WALL BRACKETS. FOR INTERIORS AND PORCH.

A - Vetri di tipo trasparenti - CLEAR GLASS

B - Vetri di tipo antincato - FROSTED GLASS

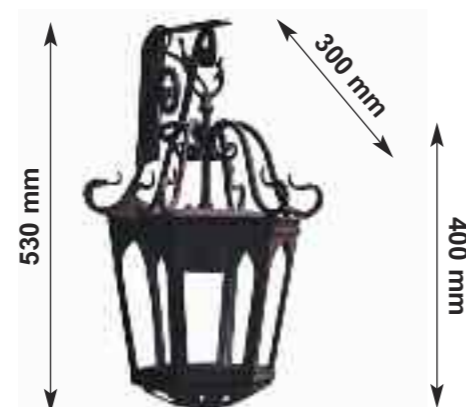

IP 23

max 60 W E 27  
230 V 50 Hz





## Art. 5902

Lanterna a Soffitto

CEILING PENDANT LANTERN

Tipica lanterna in stile medievale di forte impatto estetico, con lance e corona forgiata.  
Da interno e porticati, con vetro di tipo trasparente.

TYPICAL MEDIEVAL STYLE LANTERN.  
ELEGANT HAND FORGE AND GREAT AESTHETIC IMPACT, WITH FORGED HEAD SPEARS AND CROWN.  
FOR INTERIORS AND PORCH, CLEAR GLASS.

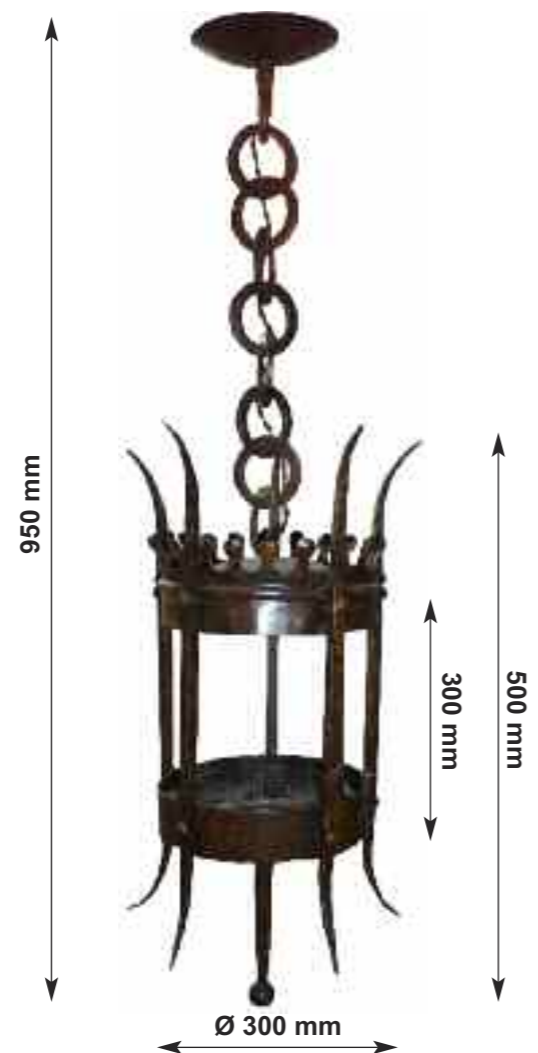

IP 23 CE  
max 60 W E 27  
230 V 50 Hz

## Art. 5905

Lanterna a Parete

WALL LANTERN

Tipica lanterna in stile medievale con braccio, di forte impatto estetico, con lance e corona forgiata.  
Per uso esterno, con vetro di tipo trasparente.

TYPICAL MEDIEVAL STYLE UP LIGHT LANTERN WITH WALL BRACKETS.  
GREAT AESTHETIC IMPACT, WITH FORGED HEAD SPEARS AND CROWN.  
FOR OUTDOOR, CLEAR GLASS.

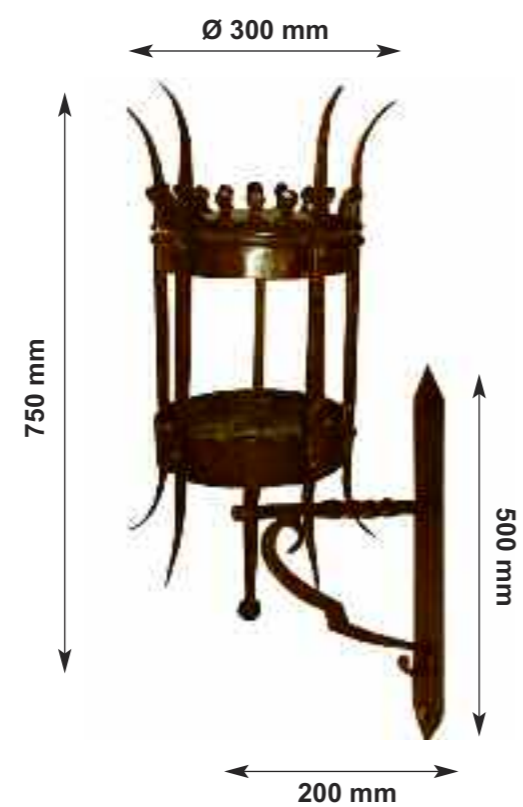

IP 23 CE  
max 60 W E 27  
230 V 50 Hz



# Art. 5901

Lanterna a Parete

WALL LANTERN

Tipica lanterna in stile medievale con braccio, di forte impatto estetico, con lance e corona forgiata.  
Per uso esterno, con vetro di tipo trasparente.

TYPICAL MEDIEVAL STYLE UP LIGHT LANTERN WITH WALL BRACKETS.  
GREAT AESTHETIC IMPACT, WITH FORGED HEAD SPEARS AND CROWN.  
FOR OUTDOOR, CLEAR GLASS.

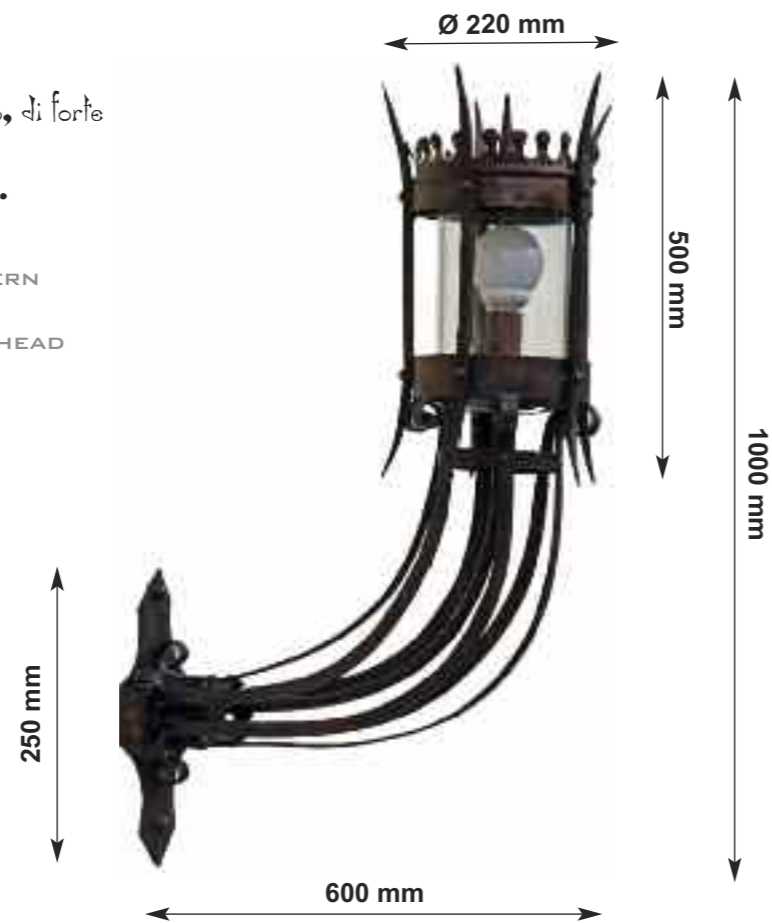

IP 23   
max 60 W E 27  
230 V 50 Hz

# Art. 5900

WALL LIGHT

Tipica lanterna in stile medievale con braccio, di forte impatto estetico, con lance e corona forgiata.  
Per uso esterno, con vetro di tipo trasparente.

TYPICAL MEDIEVAL STYLE HANGING LANTERN WITH WALL BRACKETS.  
GREAT AESTHETIC IMPACT, WITH FORGED HEAD SPEARS AND CROWN.  
FOR OUTDOOR, CLEAR GLASS.

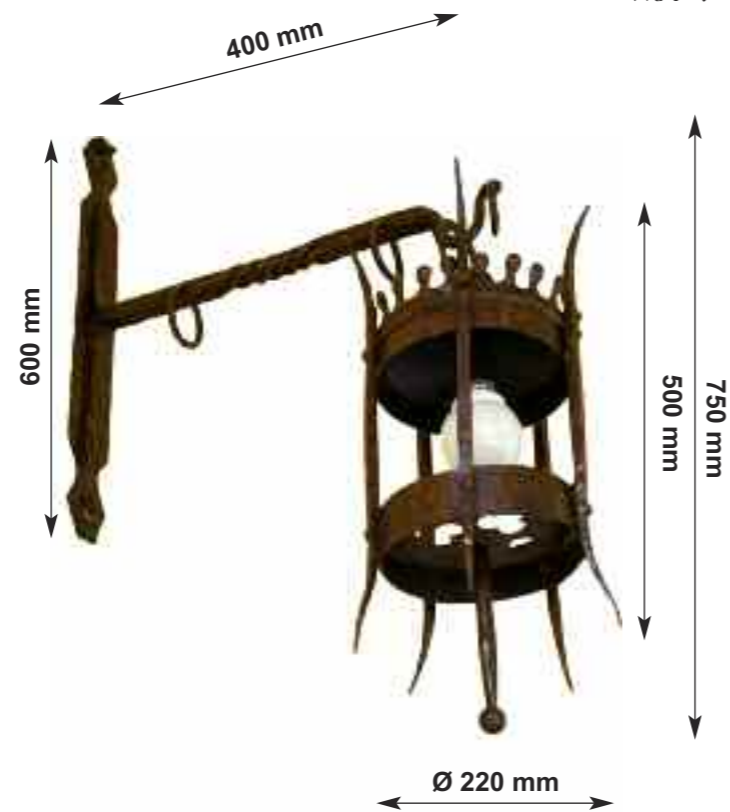

IP 23   
max 60 W E 27  
230 V 50 Hz



# Art. 5903

Lampione da Giardino

GARDEN LAMP POST

Lampada medievale da giardino di forma cilindrica, con lance e merletti forgiati.

L'altezza del palo può variare a richiesta.

Vetro di tipo trasparente.

TYPICAL MEDIEVAL STYLE CYLINDRICAL LANTERN, GREAT AESTHETIC IMPACT, WITH FORGED HEAD SPEARS AND CROWN. BESPOKE POLE HEIGHT ON REQUEST, CLEAR GLASS.

IP 23 CE  
max 60 W E 27  
230 V 50 Hz

basamento cementato a terra  
ON GROUND CEMENTED BASE



# Art. 5904

Lampione basso da Giardino

LOW LEVEL GARDEN LAMP POST

Lampada medievale da giardino o da colonna, di forma cilindrica, con lance e merletti forgiati.

L'altezza del palo può variare a richiesta.

Vetro di tipo trasparente.

TYPICAL MEDIEVAL STYLE CYLINDRICAL LANTERN, FOR GARDEN OR COLUMN TOP. GREAT AESTHETIC IMPACT, WITH FORGED HEAD SPEARS AND CROWN. BESPOKE POLE HEIGHT ON REQUEST, CLEAR GLASS.

Ø 320 mm



700 mm

2300 mm

1800 mm

300 mm

Ø 320 mm

700 mm







### Art. 5950

Lampadario  
CHANDELIER

Lampadario da interno a tre luci in stile medievale.  
Altezza della catena da soffitto variabile a piacere.

MEDIEVAL STYLE THREE LIGHT CHANDELIER FOR INTERIORS.  
THE CHAIN LENGTH CAN BE MODIFIED ON REQUEST.

- A - Vetri di tipo trasparenti - CLEAR GLASS
- B - Vetri di tipo anticato - FROSTED GLASS

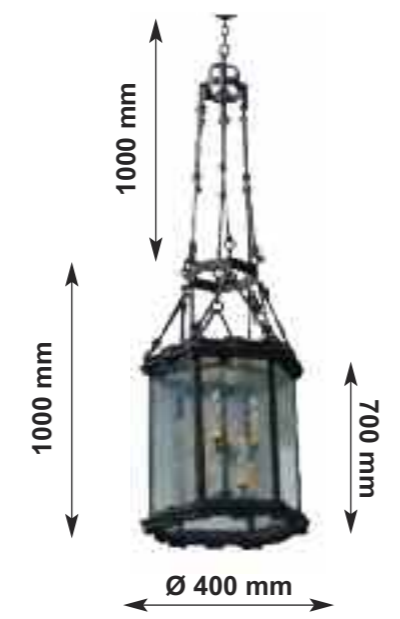

IP 20   
max 40 W x 3 E 14  
230 V 50 Hz



### Art. 5960

Lampada a Muro  
WALL LIGHT

Lampada ad una luce in stile orientale

ORIENTAL STYLE SINGLE LIGHT LAMP.

- A - Vetri di tipo trasparenti - CLEAR GLASS
- B - Vetri di tipo anticato - FROSTED GLASS



IP 20   
max 40 W E 14  
230 V 50 Hz

## Art. 5800

Lanterna da Parete

WALL LANTERN

Lanterna in stile XVI secolo italiano, da parete di medie dimensioni.

SIXTEENTH CENTURY STYLE WALL LANTERN, MEDIUM SIZE.

A - Vetri di tipo trasparenti - CLEAR GLASS

B - Vetri di tipo anticato - FROSTED GLASS

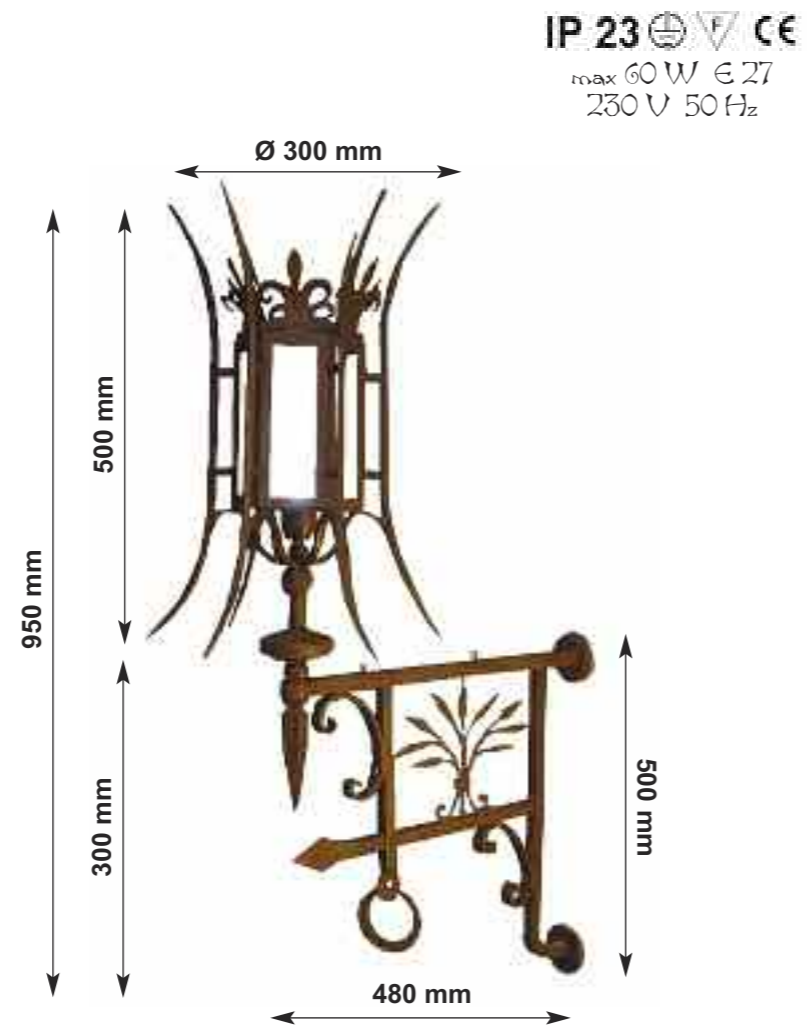

IP 23

max 60 W E 27  
230 V 50 Hz



## Art. 5810

Lanterna da Parete

WALL LANTERN

Tipica lanterna in stile rustico con braccio, forgiatura artigianale.

TYPICAL COUNTRY LIFE STYLE LANTER, WITH WALL BRACKETS, HAND FORGE.

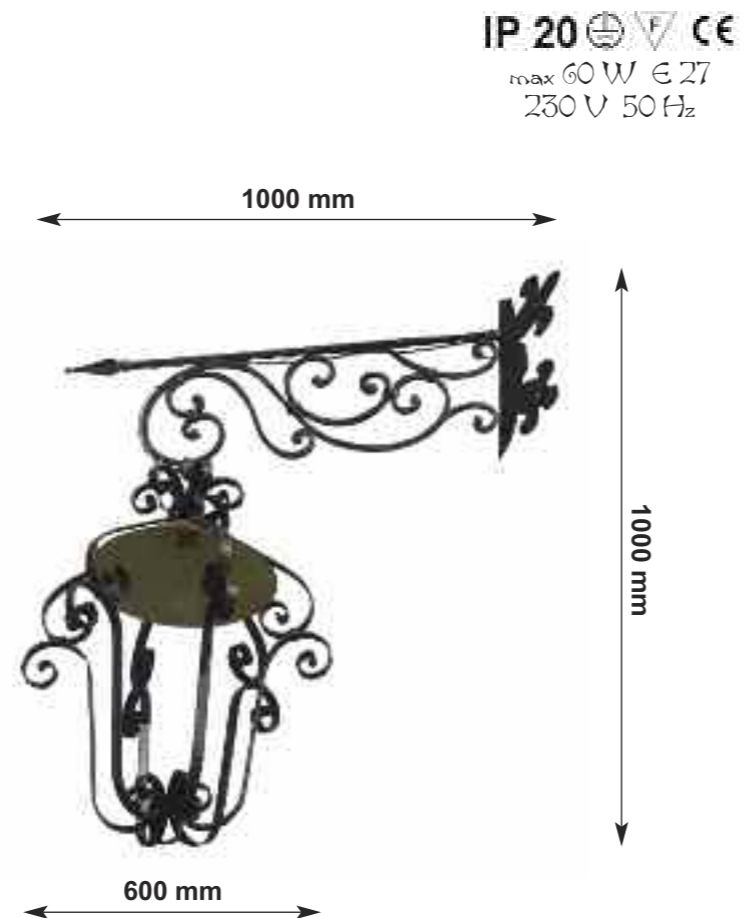

IP 20

max 60 W E 27  
230 V 50 Hz





### Art. 5530

Lanterna a Soffitto

CEILING PENDANT LANTERN

Tradizionale, semplice ed elegante lanterna in stile toscano, misura grande.  
Si possono applicare anche 3 luci.

TRADITIONAL, PLAIN, AND ELEGANT TUSCAN STYLE LANTERN, BIG SIZE.  
THREE LIGHTS ON REQUEST.

A - Vetri di tipo trasparenti - CLEAR GLASS  
B - Vetri di tipo anticato - FROSTED GLASS

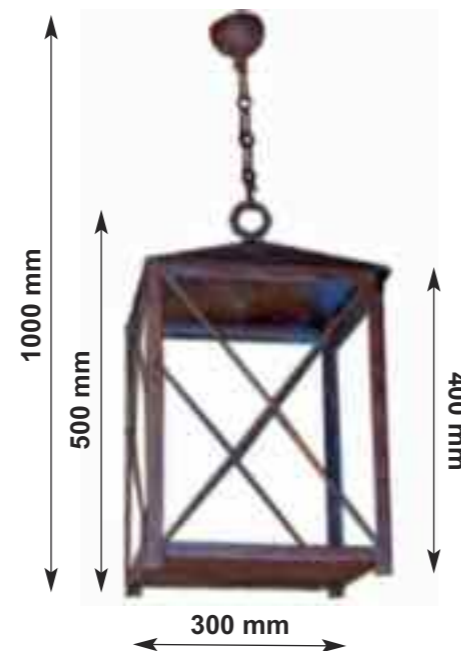

IP 20   
max 60 W E 27  
230 V 50 Hz

### Art. 5531

Lanterna a Soffitto

CEILING PENDANT LANTERN

Tradizionale, semplice ed elegante lanterna in stile toscano, misura media.  
Si possono applicare anche 3 luci.

TRADITIONAL, PLAIN, AND ELEGANT TUSCAN STYLE LANTERN, MEDIUM SIZE.  
THREE LIGHTS ON REQUEST.

A - Vetri di tipo trasparenti - CLEAR GLASS  
B - Vetri di tipo anticato - FROSTED GLASS

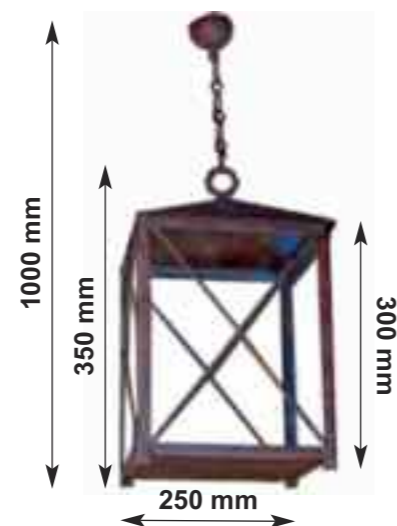

IP 20   
max 60 W E 27  
230 V 50 Hz

### Art. 5532

Lanterna a Soffitto

CEILING PENDANT LANTERN

Tradizionale, semplice ed elegante lanterna in stile toscano, misura piccola.  
Si possono applicare anche 3 luci.

TRADITIONAL, PLAIN, AND ELEGANT TUSCAN STYLE LANTERN, SMALL SIZE.  
THREE LIGHTS ON REQUEST.

A - Vetri di tipo trasparenti - CLEAR GLASS  
B - Vetri di tipo anticato - FROSTED GLASS

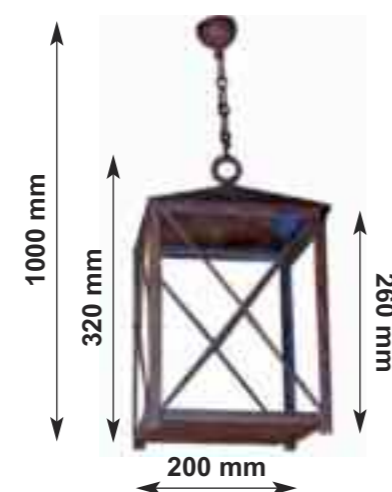

IP 20   
max 60 W E 27  
230 V 50 Hz

### Art. 5533

Lanterna a Soffitto

CEILING PENDANT LANTERN

Tradizionale, semplice ed elegante lanterna in stile toscano, misura piccola.  
Si possono applicare anche 3 luci.

TRADITIONAL, PLAIN, AND ELEGANT TUSCAN STYLE LANTERN, SMALL SIZE.  
THREE LIGHTS ON REQUEST.

A - Vetri di tipo trasparenti - CLEAR GLASS  
B - Vetri di tipo anticato - FROSTED GLASS

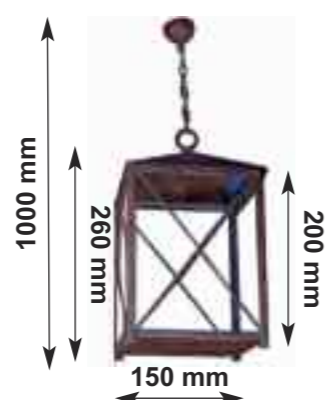

IP 20   
max 60 W E 27  
230 V 50 Hz



### Art. 5535

Lampada da parete

WALL LANTERN

Tradizionale, semplice ed elegante lanterna in stile toscano, misura media.  
Per esterno.

TRADITIONAL, PLAIN, AND ELEGANT TUSCAN STYLE LANTERN, MEDIUM SIZE.  
FOR OUTDOOR.

- A - Vetri di tipo trasparenti - CLEAR GLASS
- B - Vetri di tipo anticato - FROSTED GLASS

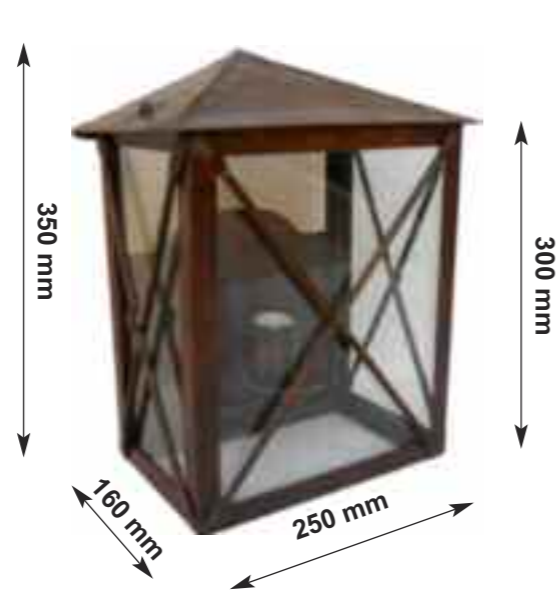

IP 23   
 max 60 W E 27  
 230 V 50 Hz

### Art. 5536

Lampada da parete

WALL LANTERN

Tradizionale, semplice ed elegante lanterna in stile toscano, misura piccola.  
Per esterno.

TRADITIONAL, PLAIN, AND ELEGANT TUSCAN STYLE LANTERN, SMALL SIZE.  
FOR OUTDOOR.

- A - Vetri di tipo trasparenti - CLEAR GLASS
- B - Vetri di tipo anticato - FROSTED GLASS



IP 23   
 max 60 W E 27  
 230 V 50 Hz

### Art. 5537

Lampada da parete

WALL LANTERN

Tradizionale, semplice ed elegante lanterna in stile toscano, misura piccola.  
Per esterno.

TRADITIONAL, PLAIN, AND ELEGANT TUSCAN STYLE LANTERN, SMALL SIZE.  
FOR OUTDOOR.

- A - Vetri di tipo trasparenti - CLEAR GLASS
- B - Vetri di tipo anticato - FROSTED GLASS

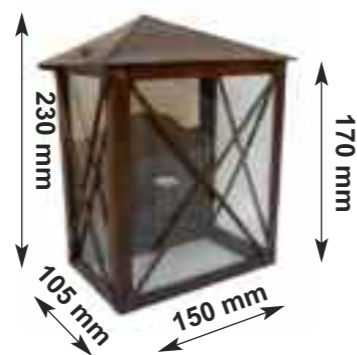

IP 23   
 max 40 W E 14  
 230 V 50 Hz

### Art. 5539

Lampione da Giardino

GARDEN LAMP POST

Tradizionale, semplice ed elegante lanterna in stile toscano.  
L'altezza del palo può variare su richiesta.

TRADITIONAL, PLAIN, AND ELEGANT TUSCAN STYLE LANTERN.  
BESPOKE POLE HEIGHT ON REQUEST.

- A - Vetri di tipo trasparenti - CLEAR GLASS
- B - Vetri di tipo anticato - FROSTED GLASS

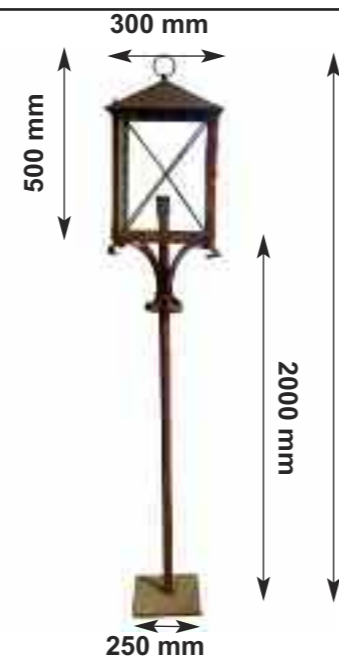

IP 23   
 max 60 W E 27  
 230 V 50 Hz





## Art. 6180

Lampada da parete

WALL LANTERN

Tradizionale, semplice ed elegante lanterna in stile toscano, di forma svasata con vetri.

TRADITIONAL, PLAIN AND ELEGANT TUSCAN STYLE LANTERN, FLARED SHAPE AND GLASS PANELS.

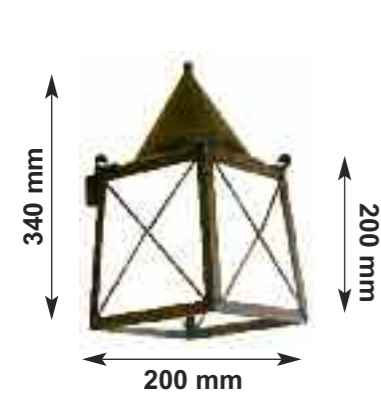

IP 23 CE  
max 60 W E 27  
230 V 50 Hz

## Art. 6182

Lampada da parete

WALL LIGHT

Tradizionale, semplice ed elegante lanterna in stile toscano, di forma svasata con vetri.  
Con piastra pialta per fissaggio su parete liscia.

TRADITIONAL, PLAIN AND ELEGANT TUSCAN STYLE LANTERN, WITH WALL BRACKETS. FLARED SHAPE AND GLASS PANELS.

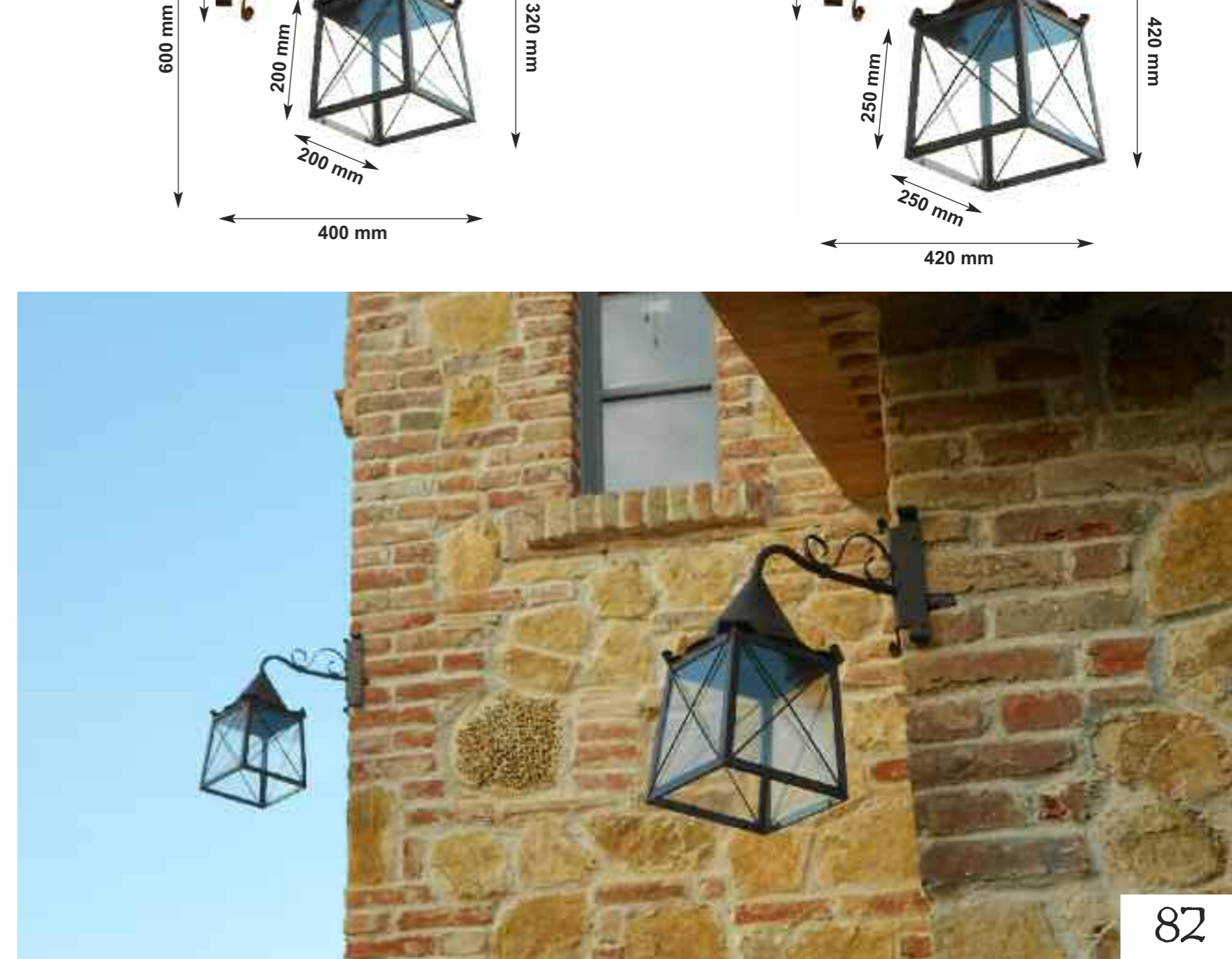
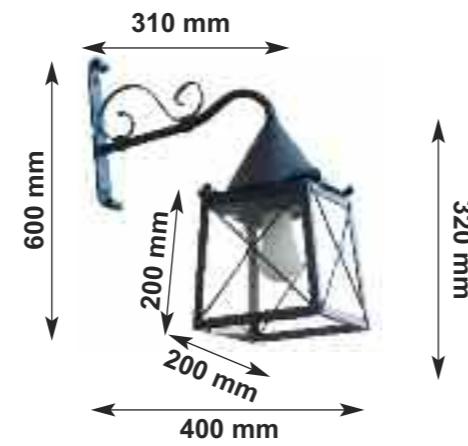

IP 23 CE  
max 60 W E 27  
230 V 50 Hz

## Art. 6183

Lampada da parete

WALL LIGHT

Tradizionale, semplice ed elegante lanterna in stile toscano, di forma svasata con vetri.  
Con piastra ad angolo per fissaggio su spigolo con corpo illuminante di piccole dimensioni.

TRADITIONAL, PLAIN AND ELEGANT TUSCAN STYLE LANTERN, WITH WALL EDGE BRACKETS. SMALL SIZE, FLARED SHAPE AND GLASS PANELS.

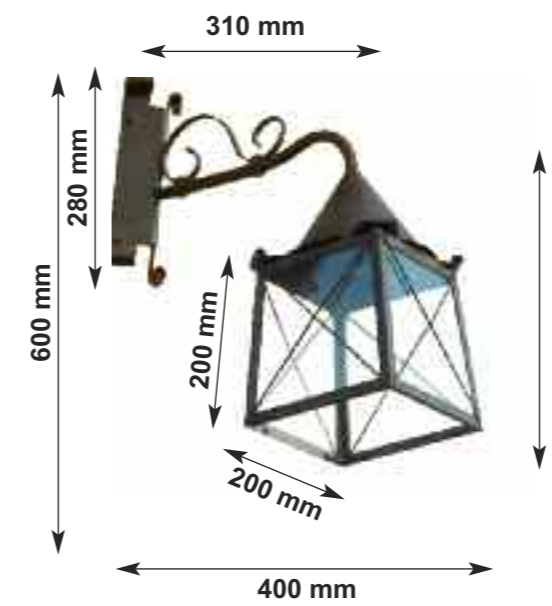

IP 23 CE  
max 60 W E 27  
230 V 50 Hz

## Art. 6184

Lampada da parete

WALL LIGHT

Tradizionale, semplice ed elegante lanterna in stile toscano, di forma svasata con vetri.  
Con piastra ad angolo per fissaggio su spigolo con corpo illuminante di medie dimensioni.

TRADITIONAL, PLAIN AND ELEGANT TUSCAN STYLE LANTERN, WITH WALL EDGE BRACKETS. MEDIUM SIZE, FLARED SHAPE AND GLASS PANELS.

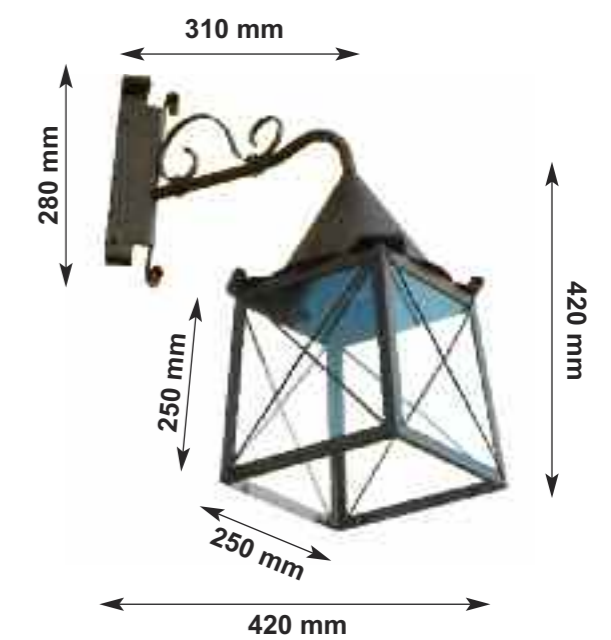

IP 23 CE  
max 60 W E 27  
230 V 50 Hz

### Art. 6185 Lanterna a Soffitto

CEILING PENDANT LANTERN

Tradizionale, semplice ed elegante lanterna in stile toscano, di forma svasata con vetri.  
La lunghezza della catena può variare in base alle esigenze, con corpo illuminante di piccole dimensioni.

TRADITIONAL, PLAIN AND ELEGANT TUSCAN STYLE LANTERN.  
SMALL SIZE, FLARED SHAPE AND GLASS PANELS.  
THE CHAIN LENGTH CAN BE MODIFIED ON REQUEST.

IP 23 CE  
max 60 W E 27  
230 V 50 Hz

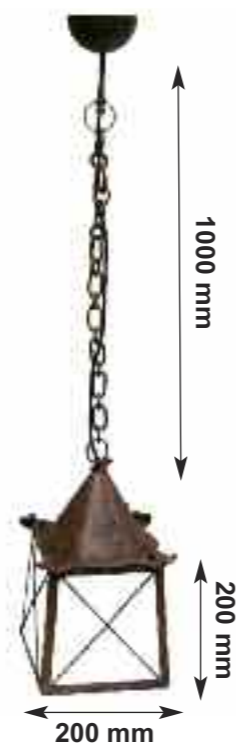

IP 23 CE  
max 60 W E 27  
230 V 50 Hz



### Art. 6186 Lanterna a Soffitto

WALL LIGHT

Tradizionale, semplice ed elegante lanterna in stile toscano, di forma svasata con vetri.  
La lunghezza della catena può variare in base alle esigenze, con corpo illuminante di medie dimensioni.

TRADITIONAL, PLAIN AND ELEGANT TUSCAN STYLE LANTERN.  
MEDIUM SIZE, FLARED SHAPE AND GLASS PANELS.  
THE CHAIN LENGTH CAN BE MODIFIED ON REQUEST.

### Art. 6187

Lanterna a Soffitto

WALL LIGHT

Tradizionale, semplice ed elegante lanterna in stile toscano, di forma svasata con vetri.  
La lunghezza della catena può variare in base alle esigenze, con corpo illuminante di grandi dimensioni.

TRADITIONAL, PLAIN AND ELEGANT TUSCAN STYLE LANTERN.  
BIG SIZE, FLARED SHAPE AND GLASS PANELS.  
THE CHAIN LENGTH CAN BE MODIFIED ON REQUEST.

IP 23 CE  
max 60 W E 27  
230 V 50 Hz

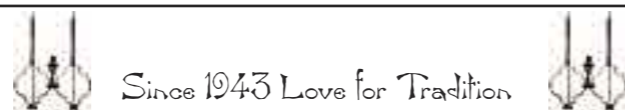
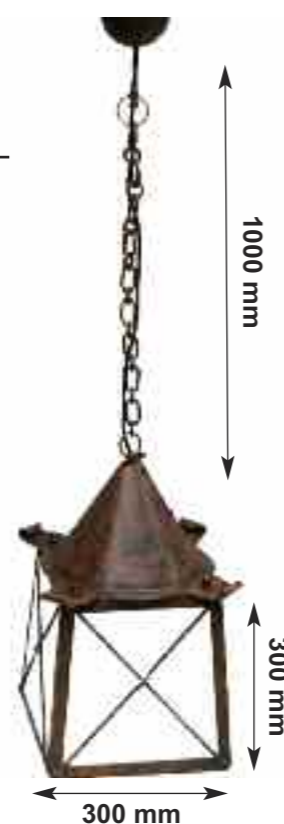



## Art. 6188

### Lampione da Giardino

GARDEN LAMP POST

Tradizionale, semplice ed elegante lanterna in stile toscano, di forma svasata con vetri. L'altezza del palo può variare in base alle esigenze.

TRADITIONAL, PLAIN AND ELEGANT TUSCAN STYLE LANTERN, FLARED SHAPE AND GLASS PANELS. BESPOKE POLE HEIGHT ON REQUEST.

basamento cementato a terra  
ON GROUND CEMENTED BASE

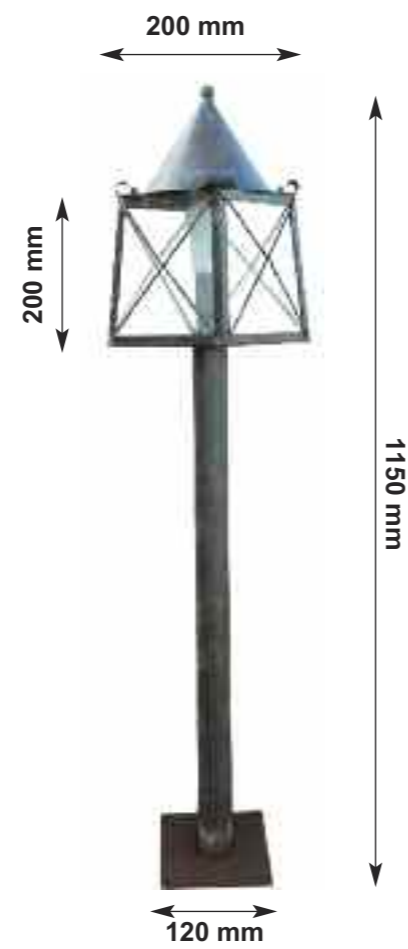

IP 23   
max 60 W E 27   
230 V 50 Hz



## Art. 6190

### Lampione da Giardino

GARDEN LOW LEVEL LAMP POST

Tradizionale, semplice ed elegante lanterna in stile toscano, di forma svasata con vetri, da giardino o da colonna. L'altezza del palo può variare in base alle esigenze.

TRADITIONAL, PLAIN AND ELEGANT TUSCAN STYLE LANTERN, FLARED SHAPE AND GLASS PANELS, FOR GARDEN OR COLUMN TOP. BESPOKE POLE HEIGHT ON REQUEST.



IP 23   
max 60 W E 27   
230 V 50 Hz





### Art. 6192

Lampione da Giardino  
WALL LIGHT

Tradizionale, semplice ed elegante lanterna in stile toscano, di forma svasata con vetri. Braccio ad arco da 100 cm. L'altezza del palo può variare in base alle esigenze.

TRADITIONAL, PLAIN AND ELEGANT TUSCAN STYLE LANTERN, FLARED SHAPE AND GLASS PANELS, WITH 100 CM ARCH ARM. BESPOKE POLE HEIGHT ON REQUEST.

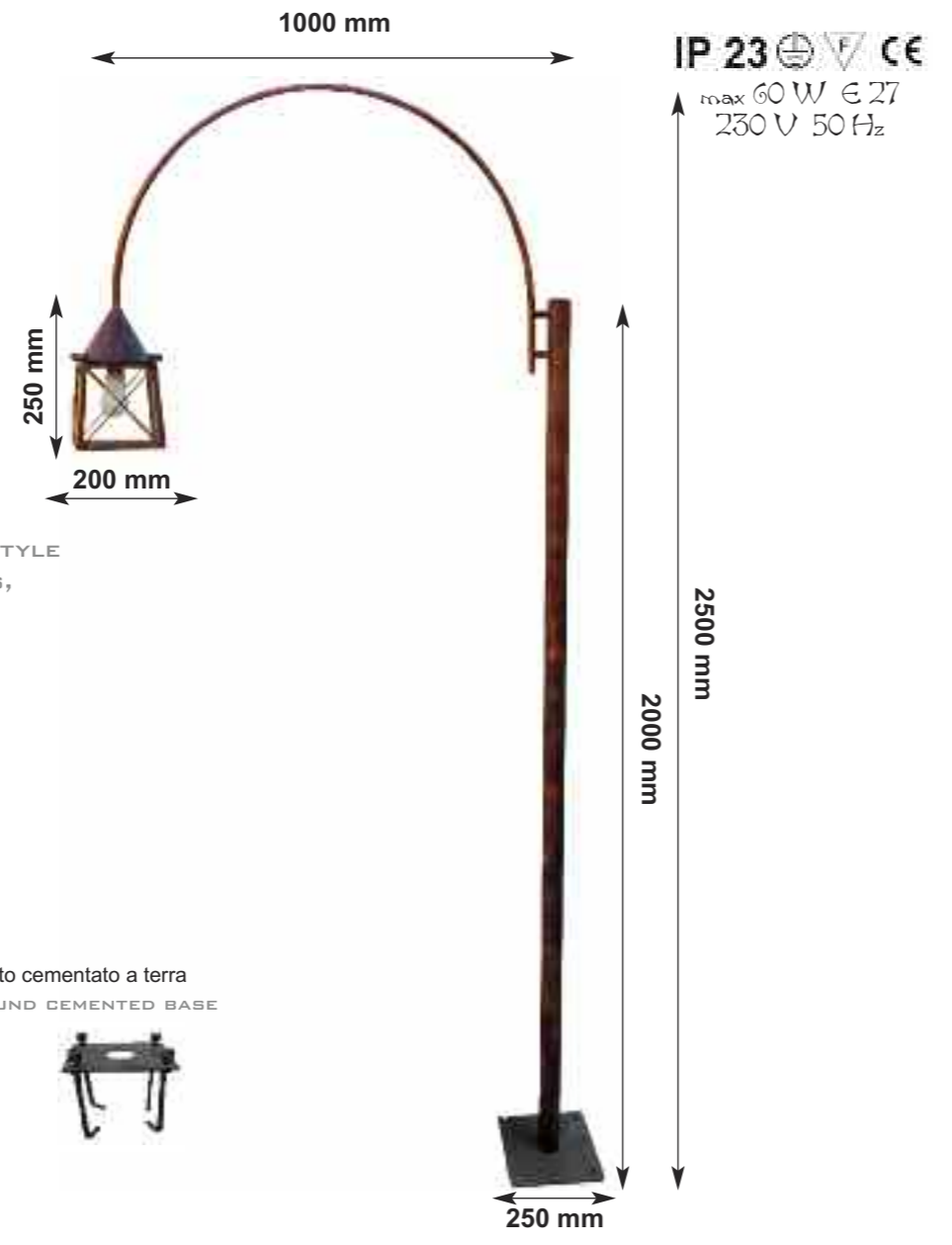

### Art. 6194

Lampione da Giardino  
WALL LIGHT

Tradizionale, semplice ed elegante lanterna in stile toscano, di forma svasata con vetri. Bracci ad arco da 100 cm. L'altezza del palo può variare in base alle esigenze.

TRADITIONAL, PLAIN AND ELEGANT TUSCAN STYLE LANTERN, FLARED SHAPE AND GLASS PANELS, WITH 100 CM DOUBLE ARCH ARM. BESPOKE POLE HEIGHT ON REQUEST.



### Art. 6193

Lampione da Giardino

WALL LIGHT

Tradizionale, semplice ed elegante lanterna in stile toscano, di forma svasata con vetri.

Braccio ad arco da 50 cm.

L'altezza del palo può variare in base alle esigenze.

TRADITIONAL, PLAIN AND ELEGANT TUSCAN STYLE LANTERN, FLARED SHAPE AND GLASS PANELS, WITH 50 CM ARCH ARM.

BESPOKE POLE HEIGHT ON REQUEST.

basamento cementato a terra  
ON GROUND CEMENTED BASE

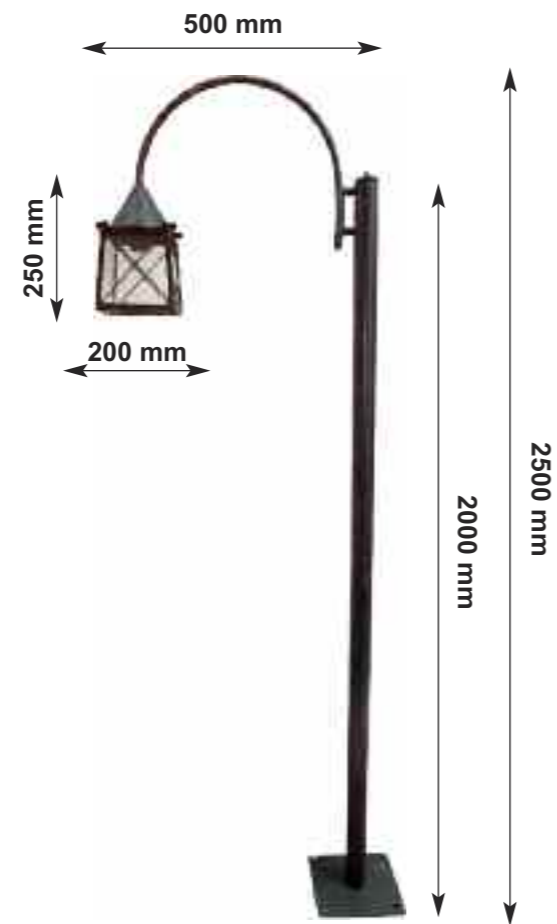

IP 23

max 60 W € 27  
230 V 50 Hz

### Art. 6195

Lampione da Giardino

WALL LIGHT

Tradizionale, semplice ed elegante lanterna in stile toscano, di forma svasata con vetri.

Braccio ad arco da 50 cm.

L'altezza del palo può variare in base alle esigenze.

TRADITIONAL, PLAIN AND ELEGANT TUSCAN STYLE LANTERN, FLARED SHAPE AND GLASS PANELS, WITH 50 CM DOUBLE ARCH ARM.

BESPOKE POLE HEIGHT ON REQUEST.

basamento cementato a terra  
ON GROUND CEMENTED BASE



IP 23

max 60 W x 2 € 27  
230 V 50 Hz

### Art. 6198

Lampada da Parete

WALL LIGHT

Tradizionale, semplice ed elegante lanterna in stile toscano, di forma svasata con vetri.

Braccio ad arco da 100 cm.

Adatta a spigoli, angoli o pareti piatte.

TRADITIONAL, PLAIN AND ELEGANT TUSCAN STYLE LANTERN, FLARED SHAPE AND GLASS PANELS, WITH 100 CM ARCH BRACKET.

IT'S FIT FOR EDGES, CORNERS, OR PLAINS WALLS.

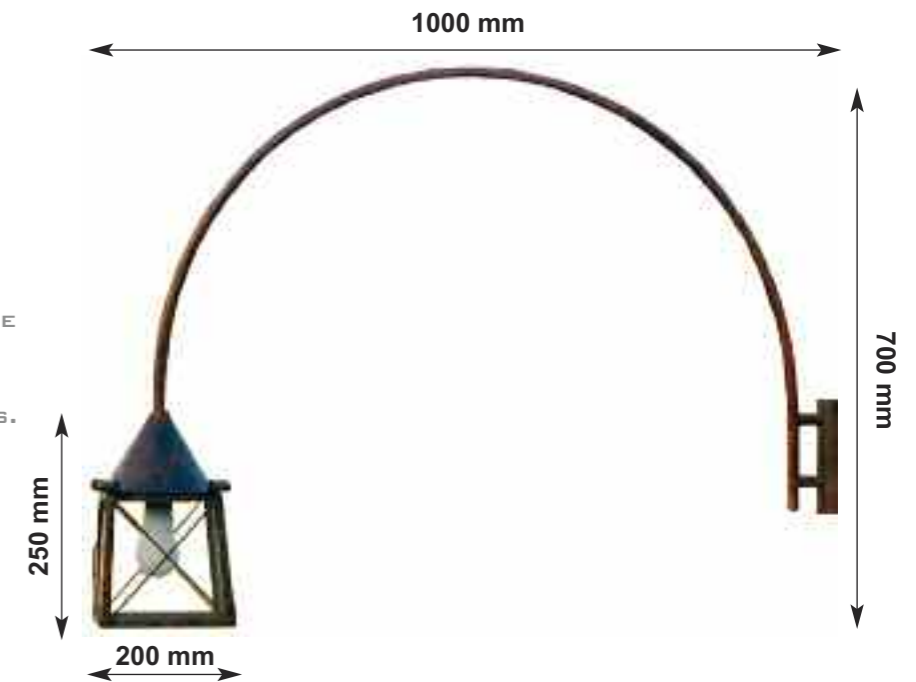

IP 23

max 60 W € 27  
230 V 50 Hz

### Art. 6199

Lampada da Parete

WALL LIGHT

Tradizionale, semplice ed elegante lanterna in stile toscano, di forma svasata con vetri.

Braccio ad arco da 50 cm.

Adatta a spigoli, angoli o pareti piatte.

TRADITIONAL, PLAIN AND ELEGANT TUSCAN STYLE LANTERN, FLARED SHAPE AND GLASS PANELS, WITH 50 CM ARCH BRACKET.

IT'S FIT FOR EDGES, CORNERS, OR PLAINS WALLS.



IP 23

max 60 W € 27  
230 V 50 Hz

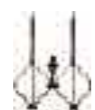

Since 1943 Love for Tradition



Since 1943 Love for Tradition



## Art. 5891

Lanterna a Soffitto

CEILING PENDANT LANTERN

Lanterna in stile classico da interno o da portico, elegante forgiatura artigianale, con foglie decorative.

CLASSIC STYLE LANTERN WITH LEAVES DECORATION, FOR INTERIORS AND PORCH. ELEGANT HAND FORGE.

A - Vetri di tipo trasparenti - CLEAR GLASS

B - Vetri di tipo anticato - FROSTED GLASS



IP 23   
max 60 W E 27  
230 V 50 Hz

## Art. 5893

Lanterna da Giardino

GARDEN LOW LEVEL LAMP POST

Lanterna in stile classico da giardino o da colonna, elegante forgiatura artigianale, con foglie decorative.

CLASSIC STYLE LANTERN WITH LEAVES DECORATION, FOR GARDEN OR COLUMN TOP. ELEGANT HAND FORGE.

A - Vetri di tipo trasparenti - CLEAR GLASS

B - Vetri di tipo anticato - FROSTED GLASS



IP 23   
max 60 W E 27  
230 V 50 Hz



# Misura Piccola SMALL SIZE

## Art. 5890

Lanterna da Parete

WALL LIGHT

Lanterna in stile classico da interno o da portico, elegante forgiatura artigianale, con foglie decorative.

CLASSIC STYLE LANTERN WITH LEAVES DECORATION, FOR INTERIORS AND PORCH. ELEGANT HAND FORGE.

A - Vetri di tipo trasparenti - CLEAR GLASS

B - Vetri di tipo anticondensation - FROSTED GLASS



IP 23   
 max 60 W E 27   
 230 V 50 Hz

## Art. 5892

Lanterna da Parete

WALL LIGHT

Lanterna in stile classico da interno o da portico, con braccio e piastra a muro, elegante forgiatura artigianale, con foglie decorative.

CLASSIC STYLE LANTERN WITH LEAVES DECORATION, FOR INTERIORS AND PORCH. ELEGANT HAND FORGE AND DECORATIVE WALL BRACKETS.

A - Vetri di tipo trasparenti - CLEAR GLASS

B - Vetri di tipo anticondensation - FROSTED GLASS

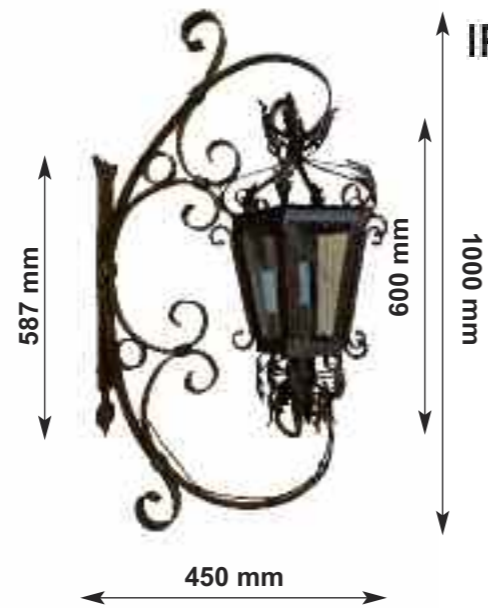

IP 23   
 max 60 W E 27   
 230 V 50 Hz

## Art. 5894

Lanterna da Parete

WALL LIGHT

Lanterna in stile classico da interno o da portico, con braccio e piastra a muro, elegante forgiatura artigianale, con foglie decorative.

CLASSIC STYLE LANTERN WITH LEAVES DECORATION, FOR INTERIORS AND PORCH. ELEGANT HAND FORGE AND WALL BRACKETS.

A - Vetri di tipo trasparenti - CLEAR GLASS

B - Vetri di tipo anticondensation - FROSTED GLASS



IP 23   
 max 60 W E 27   
 230 V 50 Hz



Since 1943 Love for Tradition

www.armoniedepoca.com

# Misura Piccola SMALL SIZE

## Art. 5895

Lampione da Giardino

GARDEN LAMP POST

Lampione in stile classico da giardino ad una luce, con foglie decorative ed elegante forgiatura artigianale. L'altezza del palo può variare a richiesta.

CLASSIC STYLE SINGLE LIGHT LAMP POST WITH LEAVES DECORATION AND ELEGANT HAND FORGE. BESPOKE POLE HEIGHT ON REQUEST.

- A - Vetri di tipo trasparenti - CLEAR GLASS
- B - Vetri di tipo anticato - FROSTED GLASS



IP 23 CE  
max 60 W € 27  
230 V 50 Hz

basamento cementato a terra  
ON GROUND CEMENTED BASE



## Art. 5896

Lampione da Giardino

GARDEN LAMP POST

Lampione in stile classico da giardino a due bracci, con foglie decorative ed elegante forgiatura artigianale. L'altezza del palo può variare a richiesta.

CLASSIC STYLE DOUBLE ARM LAMP POST WITH LEAVES DECORATION AND ELEGANT HAND FORGE. BESPOKE POLE HEIGHT ON REQUEST.

- A - Vetri di tipo trasparenti - CLEAR GLASS
- B - Vetri di tipo anticato - FROSTED GLASS

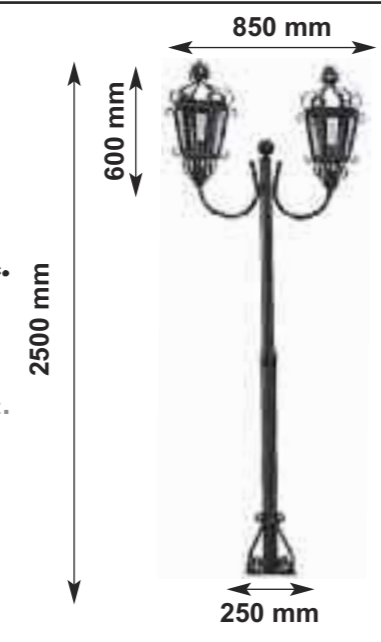

IP 23 CE  
max 60 W x 2 € 27  
230 V 50 Hz

basamento cementato a terra  
ON GROUND CEMENTED BASE



## Art. 5897

Lampione da Giardino

GARDEN LAMP POST

Lampione in stile classico da giardino a tre bracci, con foglie decorative ed elegante forgiatura artigianale. L'altezza del palo può variare a richiesta.

CLASSIC STYLE THREE ARM LAMP POST WITH LEAVES DECORATION AND ELEGANT HAND FORGE. BESPOKE POLE HEIGHT ON REQUEST.

- A - Vetri di tipo trasparenti - CLEAR GLASS
- B - Vetri di tipo anticato - FROSTED GLASS

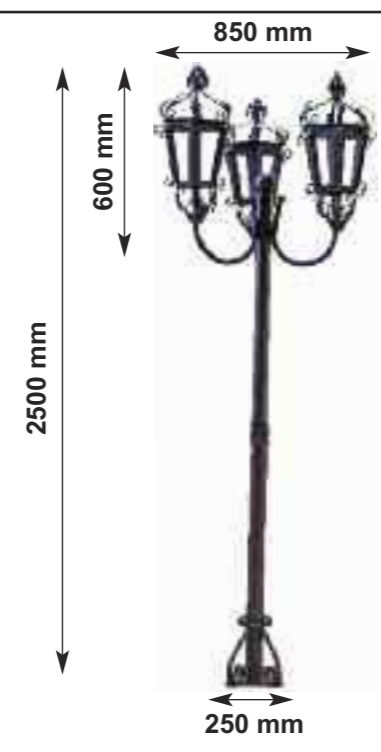

IP 23 CE  
max 60 W x 3 € 27  
230 V 50 Hz

basamento cementato a terra  
ON GROUND CEMENTED BASE



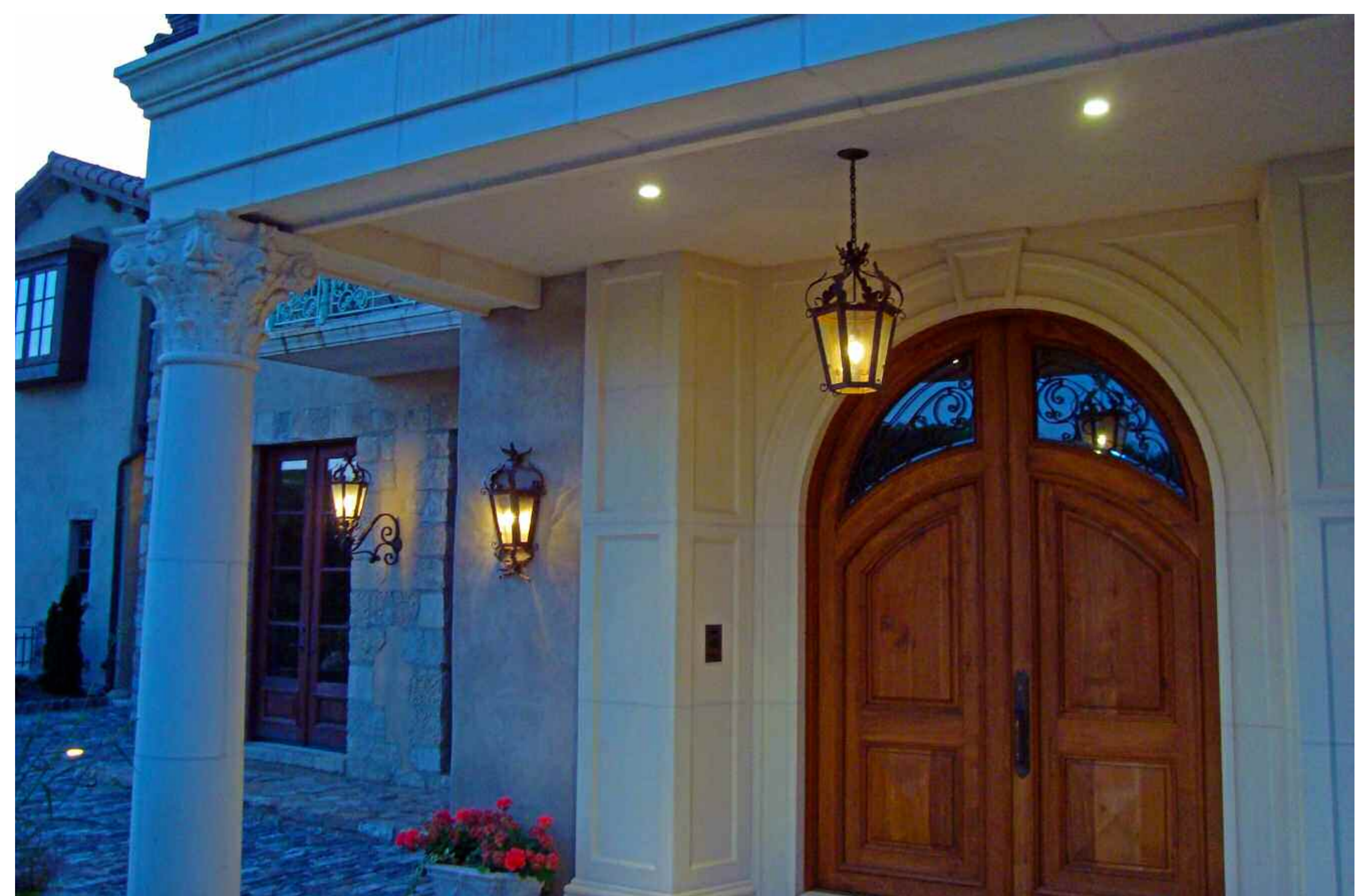

## Art. 5510

## Lanterna a soffitto

CEILING PENDANT LANTERN

Lanterna in stile classico da soffitto, con foglie decorative ed elegante forgiatura artigianale.  
Per interi ed esterni.

CLASSIC STYLE LANTERN WITH LEAVES DECORATION AND ELEGANT HAND FORGE.  
FOR INTERIORS AND OUTDOOR.

A - Vetri di tipo trasparenti - CLEAR GLASS

B - Vetri di tipo anticato - FROSTED GLASS

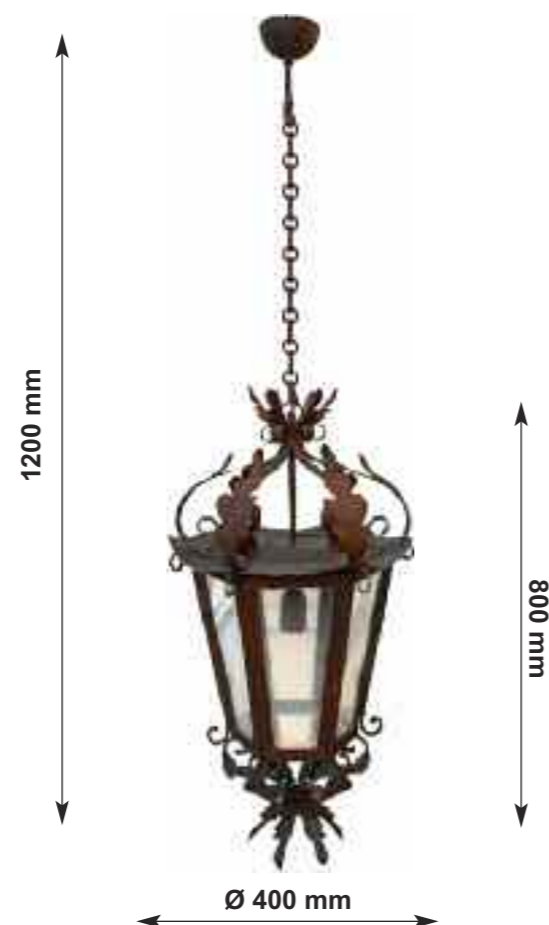

IP 23

max 60 W E 27  
230 V 50 Hz

## Art. 5519

## Lampadario a soffitto

CEILING PENDANT LANTERN

Lanterna in stile classico da soffitto, con elegante forgiatura artigianale.  
Per interi ed esterni.

CLASSIC STYLE LANTERN WITH ELEGANT HAND FORGE.  
FOR INTERIORS AND OUTDOOR.

A - Vetri di tipo trasparenti - CLEAR GLASS

B - Vetri di tipo anticato - FROSTED GLASS



IP 23

max 60 W E 27  
230 V 50 Hz





# Misura Media

MEDIUM SIZE

## Art. 5511

Lanterna da Parete

WALL LANTERN

Lanterna in stile classico di grandi dimensioni, con foglie decorative ed elegante forgiatura artigianale. da interno o da esterno.

BIG SIZE CLASSIC STYLE LANTERN, WITH LEAVES DECORATION AND ELEGANT HAND FORGE. FOR INTERIORS AND OUTDOOR.

A - Vetri di tipo trasparenti - CLEAR GLASS

B - Vetri di tipo anticato - FROSTED GLASS



IP 23   
 max 60 W E 27   
 230 V 50 Hz



## Art. 5512

Lanterna da Parete

WALL LANTERN

Lanterna con braccio a parete, in stile classico di grandi dimensioni, con foglie decorative ed elegante forgiatura artigianale.

Da esterno.

BIG SIZE CLASSIC STYLE LANTERN, WITH LEAVES DECORATION AND DECORATIVE WALL BRACKETS. ELEGANT HAND FORGE. FOR OUTDOOR.

A - Vetri di tipo trasparenti - CLEAR GLASS

B - Vetri di tipo anticato - FROSTED GLASS

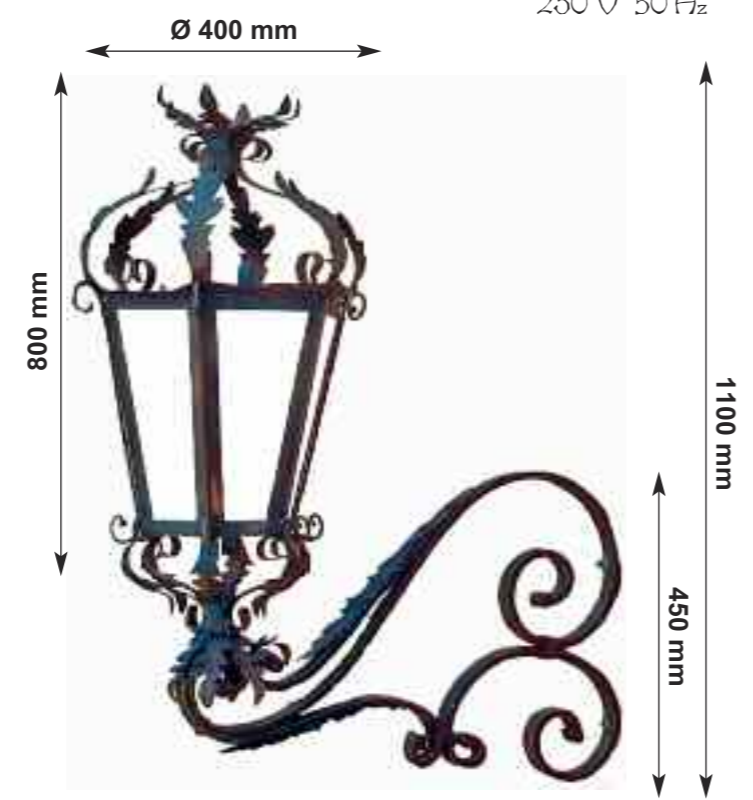

IP 23   
 max 60 W E 27   
 230 V 50 Hz





# Misura Media

## MEDIUM SIZE

### Art. 5513

Lampione da Giardino

GARDEN LAMP POST

Lampione in stile classico da giardino ad una luce, con foglie decorative ed elegante forgiatura artigianale. L'altezza del palo può variare a richiesta.

CLASSIC STYLE SINGLE LIGHT LAMP POST WITH LEAVES DECORATION AND ELEGANT HAND FORGE. BESPOKE POLE HEIGHT ON REQUEST.

A - Vetri di tipo trasparenti - CLEAR GLASS

B - Vetri di tipo anticato - FROSTED GLASS



IP 23

max 60 W € 27  
230 V 50 Hz

basamento cementato a terra  
ON GROUND CEMENTED BASE



### Art. 5514

Lampione da Giardino

GARDEN LAMP POST

Lampione in stile classico da giardino ad una luce, con foglie decorative ed elegante forgiatura artigianale. L'altezza del palo può variare a richiesta.

CLASSIC STYLE SINGLE LIGHT LAMP POST WITH LEAVES DECORATION AND ELEGANT HAND FORGE. BESPOKE POLE HEIGHT ON REQUEST.

A - Vetri di tipo trasparenti - CLEAR GLASS

B - Vetri di tipo anticato - FROSTED GLASS

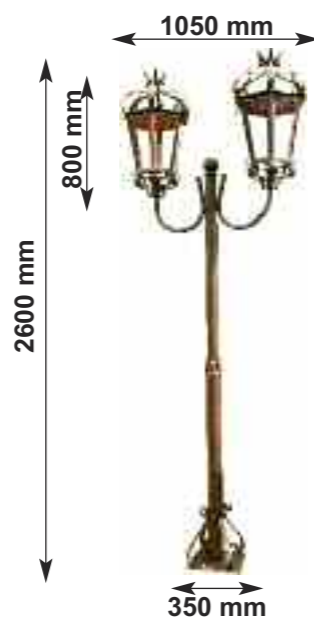

IP 23

max 60 W x 2 € 27  
230 V 50 Hz

basamento cementato a terra  
ON GROUND CEMENTED BASE



### Art. 5515

Lampione da Giardino

GARDEN LAMP POST

Lampione in stile classico da giardino ad una luce, con foglie decorative ed elegante forgiatura artigianale. L'altezza del palo può variare a richiesta.

CLASSIC STYLE SINGLE LIGHT LAMP POST WITH LEAVES DECORATION AND ELEGANT HAND FORGE. BESPOKE POLE HEIGHT ON REQUEST.

A - Vetri di tipo trasparenti - CLEAR GLASS

B - Vetri di tipo anticato - FROSTED GLASS



IP 23

max 60 W x 3 € 27  
230 V 50 Hz

basamento cementato a terra  
ON GROUND CEMENTED BASE

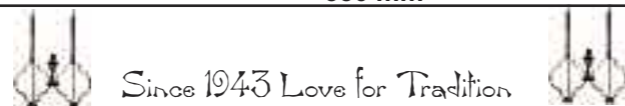

Since 1943 Love for Tradition

www.armoniedepoca.com





Art. 5520

Lanterna da Soffitto

CEILING PENDANT LANTERN

Tipica lanterna in stile classico con foglie decorative e elegante forgiatura.

Le sue importanti dimensioni la rendono adatta per soffitti alti, ambienti ampi e di prestigio.

Possibilità di montare 1 luce, 3 luci, o 5 luci.

TYPICAL CLASSIC STYLE LANTERN WITH LEAVES DECORATION AND ELEGANT HAND FORGE.

ITS CONSIDERABLE DIMENSIONS ARE WELL SUITED TO HIGH CEILINGS, LARGE AND PRESTIGIOUS ROOMS.

AVAILABLE WITH 1, 3, OR 5 LIGHTS.

A - Vetri di tipo trasparenti - CLEAR GLASS

B - Vetri di tipo antincato - FROSTED GLASS



IP 20   
max 60 W x3 E 27  
230 V 50 Hz

Art. 5525

Lampadario da Soffitto

CEILING PENDANT LANTERN

Tipica lanterna in stile medievale con foglie decorative e elegante forgiatura.

Le sue importanti dimensioni la rendono adatta per soffitti alti, ambienti ampi e di prestigio.

Possibilità di montare 1 luce, 3 luci, o 5 luci.

TYPICAL MEDIEVAL STYLE LANTERN WITH LEAVES DECORATION AND ELEGANT HAND FORGE.

ITS CONSIDERABLE DIMENSIONS ARE WELL SUITED TO HIGH CEILINGS, LARGE AND PRESTIGIOUS ROOMS.

AVAILABLE WITH 1, 3, OR 5 LIGHTS.

A - Vetri di tipo trasparenti - CLEAR GLASS

B - Vetri di tipo antincato - FROSTED GLASS

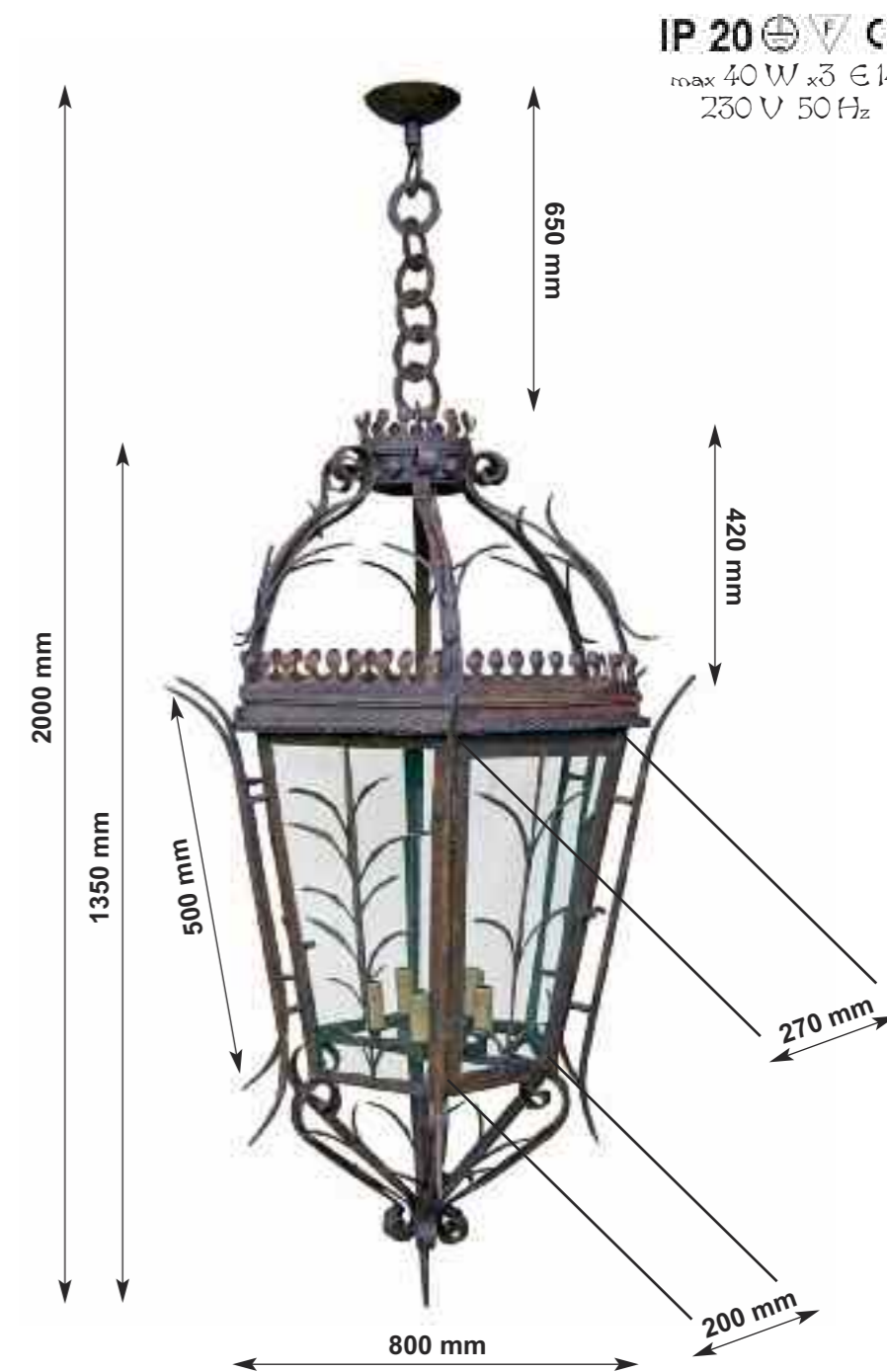

IP 20   
max 40 W x3 E 14  
230 V 50 Hz

Art. 5526

Variante con Appoggio su Colonna

PEDESTAL OPTION FOR COLUMN TOP

A - Vetri di tipo trasparenti - CLEAR GLASS

B - Vetri di tipo antincato - FROSTED GLASS



IP 20   
max 40 W x3 E 14  
230 V 50 Hz

# Misura Grande LARGE SIZE

## Art. 5521

Lanterna da Parete  
WALL LANTERN

Tipica lanterna in stile classico di grandi dimensioni da esterno, con foglie decorative e elegante forgiatura.

TYPICAL CLASSIC STYLE HANGING LANTERN WITH WALL BRACKETS, BIG SIZE, WITH LEAVES DECORATION AND ELEGANT HAND FORGE.

- A - Vetri di tipo trasparenti - CLEAR GLASS
- B - Vetri di tipo antincato - FROSTED GLASS



## Art 5522

Lanterna da parete  
WALL LANTERN

Tipica lanterna in stile classico di grandi dimensioni da esterno, con foglie decorative e elegante forgiatura.

TYPICAL CLASSIC STYLE HANGING LANTERN WITH WALL BRACKETS, BIG SIZE, WITH LEAVES DECORATION AND ELEGANT HAND FORGE.

- A - Vetri di tipo trasparenti - CLEAR GLASS
- B - Vetri di tipo antincato - FROSTED GLASS



### Art. 5222

Lampadario  
CEILING PENDANT LIGHT

Lampadario sospensione a tre luci.  
Stile arte povera con foglie avvolte allo stelo della lampada.

THREE LIGHT COUNTRY LIFE STYLE CEILING  
PENDANT LAMP.  
WITH LEAVES WRAPPED AROUND IT.

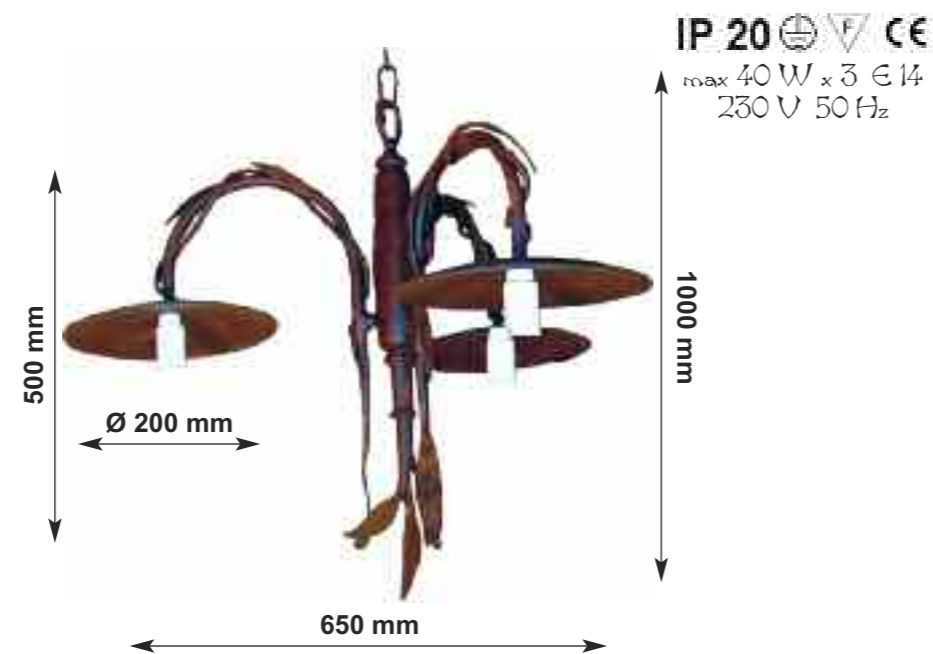

IP 20 CE  
max 40 W x 3 E 14  
230 V 50 Hz



### Art. 5771

Applique  
WALL LIGHT

Lampada a muro a due luci, di piccole dimensioni.  
Stile arte povera con foglie avvolte allo stelo della lampada.

TWIN LIGHT COUNTRY LIFE STYLE LAMP,  
SMALL SIZE.  
WITH LEAVES WRAPPED AROUND IT.

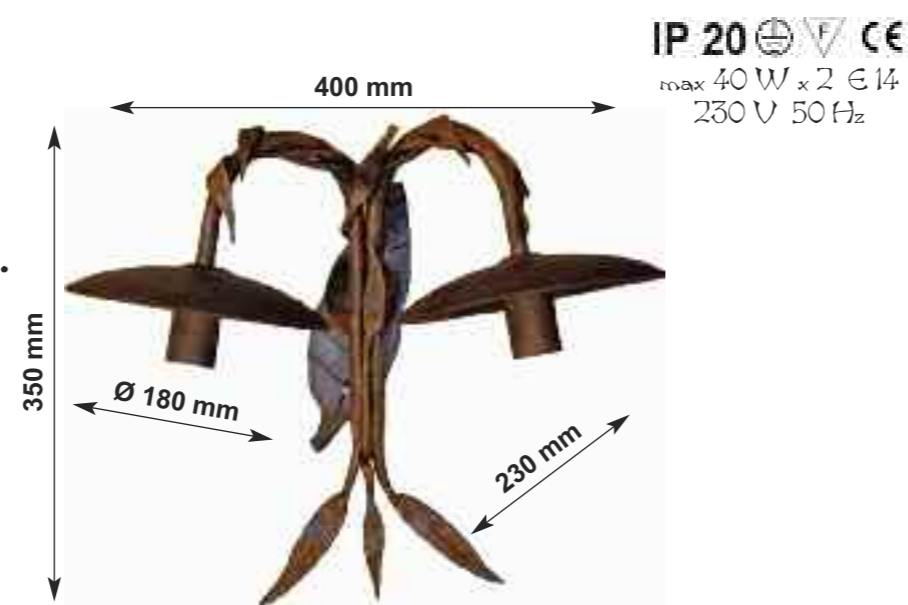

IP 20 CE  
max 40 W x 2 E 14  
230 V 50 Hz



### Art. 5770

Appique  
WALL LIGHT

Lampada a muro ad una luce, di piccole dimensioni.  
Stile arte povera con foglie avvolte allo stelo della lampada.

SINGLE LIGHT COUNTRY LIFE STYLE LAMP,  
SMALL SIZE.  
WITH LEAVES WRAPPED AROUND IT.

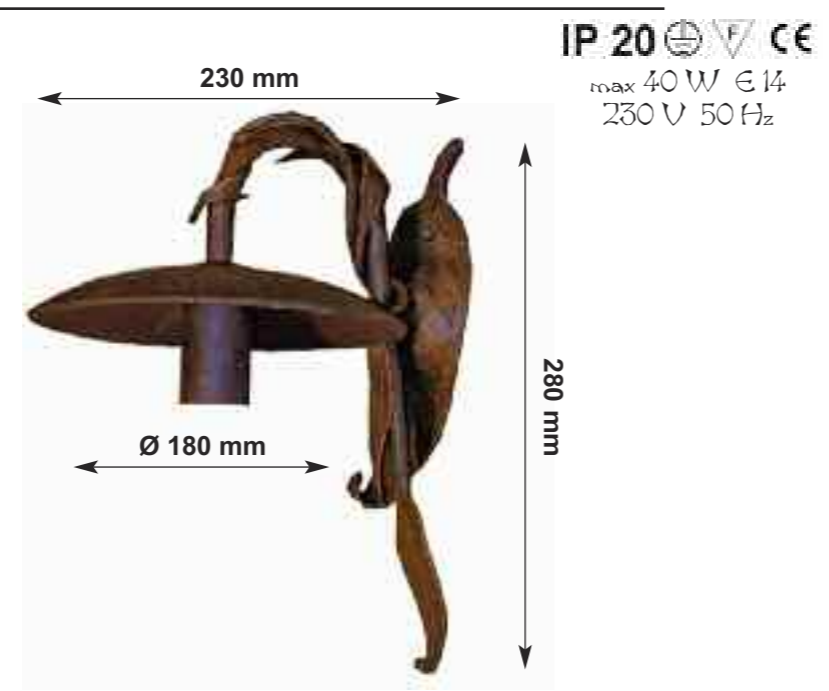

IP 20 CE  
max 40 W E 14  
230 V 50 Hz



### Art. 5221

Lampadario  
CEILING PENDANT LIGHT

Lampadario sospensione a tre luci.  
Stile arte povera con foglie di ferro forgiate a mano, avvolte allo stelo della lampada.

THREE LIGHT COUNTRY LIFE STYLE CEILING PENDANT LAMP.  
WITH IRON HAND FORGED TWISTED LEAVES.

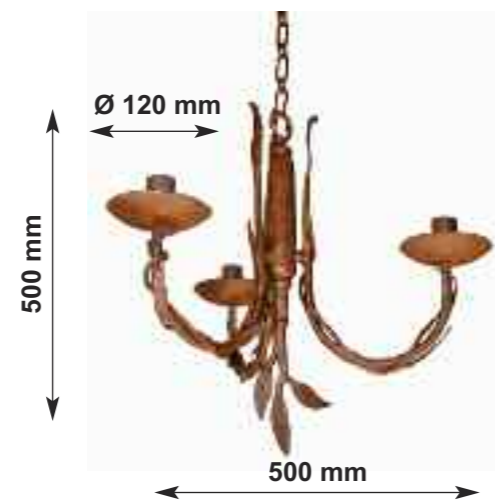

IP 20   
max 40 W x 3 E 14  
230 V 50 Hz

### Art. 5774

Applique  
WALL LIGHT

Lampada a muro a due luci, di piccole dimensioni.  
Stile arte povera con foglie di ferro forgiate a mano, avvolte allo stelo della lampada.

TWIN LIGHT COUNTRY LIFE STYLE LAMP,  
SMALL SIZE.  
WITH IRON HAND FORGED TWISTED LEAVES.

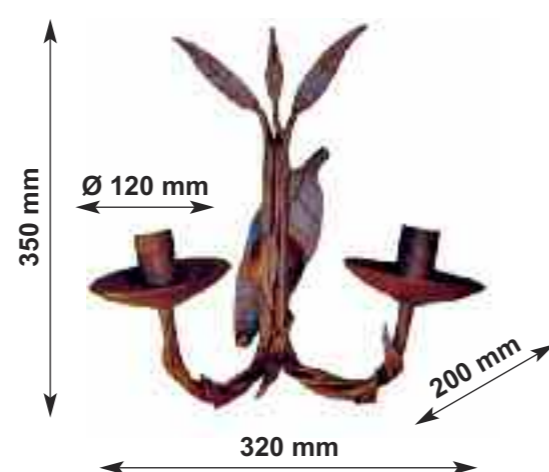

IP 20   
max 40 W x 2 E 14  
230 V 50 Hz

### Art. 5773

Applique  
WALL LIGHT

Lampada a muro ad una luce, di piccole dimensioni.  
Stile arte povera con foglie di ferro forgiate a mano, avvolte allo stelo della lampada.

SINGLE LIGHT COUNTRY LIFE STYLE LAMP,  
SMALL SIZE.  
WITH IRON HAND FORGED TWISTED LEAVES.

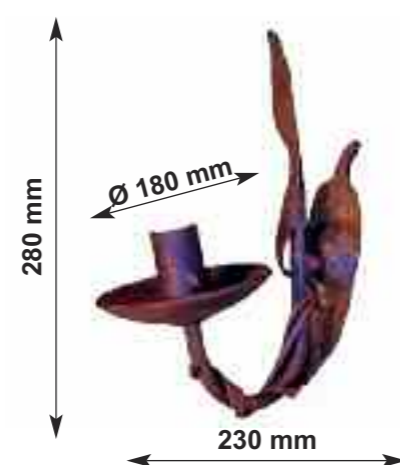

IP 20   
max 40 W E 14  
230 V 50 Hz

### Art. 5778

Plafoniera  
CEILING LIGHT

Plafoniera da soffitto, stile arte povera con foglie di ferro forgiate a mano, avvolte allo stelo della lampada.

Può essere installata come applique.

COUNTRY LIFE STYLE LAMP, WITH IRON HAND FORGED TWISTED LEAVES AND BRANCHES DECORATION.

IT CAN BE USED AS WALL LIGHT.

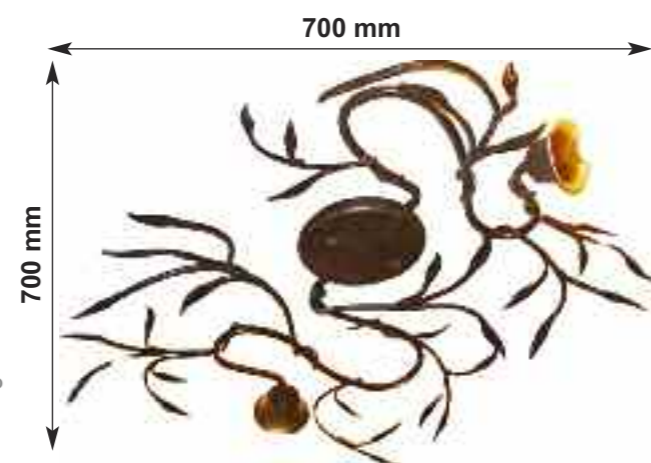

IP 20   
max 40 W x 2 E 14  
230 V 50 Hz



### Art. 5911

Applique

WALL LIGHT

Lampada a parete ad una luce in stile fiorentino, foglia in ferro pesante forgiato a mano.

FLORENTINE STYLE SINGLE LIGHT LAMP. LEAF SHAPE, THICK HAND FORGED IRON.



IP 20   
max 40 W  $\epsilon$  14  
230 V 50 Hz

### Art. 5912

Applique

WALL LIGHT

Lampada a parete a due luci in stile fiorentino, foglia in ferro pesante forgiato a mano.

FLORENTINE STYLE DOUBLE LIGHT LAMP. LEAF SHAPE, THICK HAND FORGED IRON.



IP 20   
max 40 W x 2  $\epsilon$  14  
230 V 50 Hz

### Art. 5913

Applique

WALL LIGHT

Lampada a parete a tre luci in stile fiorentino, foglia in ferro pesante forgiato a mano.

FLORENTINE STYLE TRIPLE LIGHT LAMP. LEAF SHAPE, THICK HAND FORGED IRON.



IP 20   
max 40 W x 3  $\epsilon$  14  
230 V 50 Hz



### Art. 5914

Applique

WALL LIGHT

Lampada a parete a due luci in stile fiorentino, foglia in ferro pesante forgiato a mano.

FLORENTINE STYLE TWIN LIGHT LAMP. LEAF SHAPE, THICK HAND FORGED IRON.

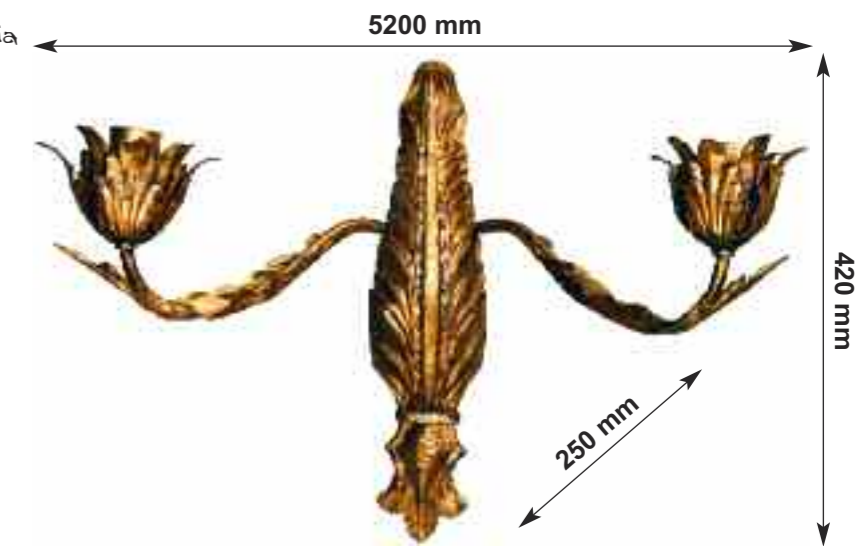

IP 20   
max 40 W x 2  $\epsilon$  14  
230 V 50 Hz

# Art. 5590

Applique  
WALL LIGHT

Tipico lampioncino da parete in arte povera di piccole dimensioni, da interno o da esterno.

TYPICAL PLAIN COUNTRY LIFE STYLE LAMP, SMALL SIZE, FOR INTERIORS AND OUTDOOR.

IP 20 CE  
max 40 W E 14  
230 V 50 Hz



## Art. 5591

Applique per angolo  
WALL LIGHT  
WITH CORNER BRACKETS

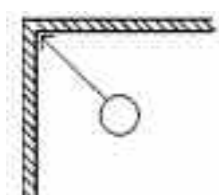

## Art. 5592

Applique per spigolo  
WALL LIGHT  
WITH EDGE BRACKETS

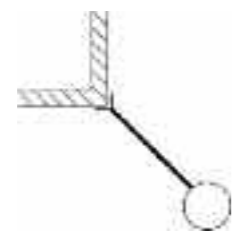

# Art. 5610

Applique  
WALL LIGHT

Tipico lampioncino da parete in arte povera di medie dimensioni, da interno o da esterno.

TYPICAL PLAIN COUNTRY LIFE STYLE LAMP, MEDIUM SIZE, FOR INTERIORS AND OUTDOOR.

IP 20 CE  
max 60 W E 27  
230 V 50 Hz

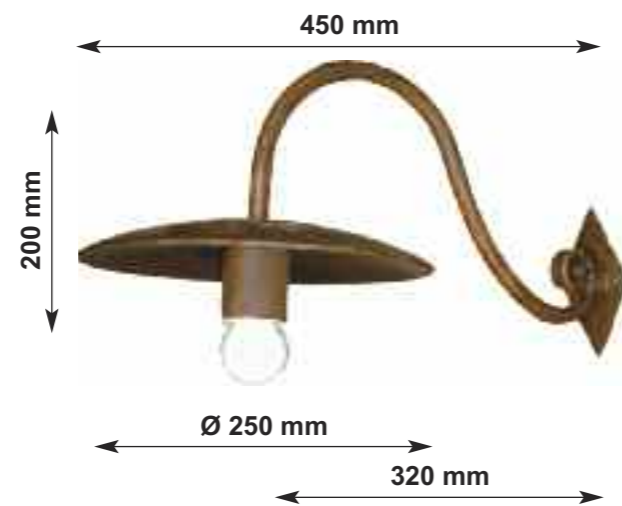

### Art. 5620

Applique  
WALL LIGHT

Tipico lampioncino da parete in arte povera ad una luce, di piccole dimensioni, da interno o da esterno.

TYPICAL COUNTRY LIFE STYLE LAMP, SINGLE LIGHT, SMALL SIZE, FOR INTERIORS AND OUTDOOR.

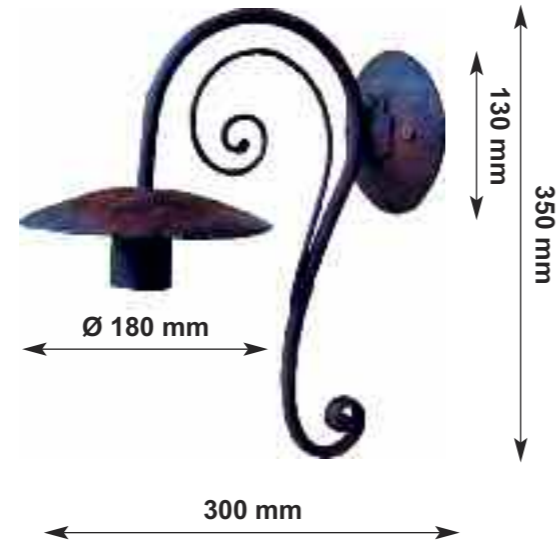

IP 20   
 max 40 W  $\epsilon$  14   
 230 V 50 Hz

### Art. 5630

Applique  
WALL LIGHT

Tipico lampioncino da parete in arte povera a due luci, di piccole dimensioni, da interno o da esterno.

TYPICAL COUNTRY LIFE STYLE LAMP, TWIN LIGHT, SMALL SIZE, FOR INTERIORS AND OUTDOOR.



IP 20   
 max 40 W x 2  $\epsilon$  14   
 230 V 50 Hz

### Art. 5100

lampadario a soffitto  
CEILING PENDANT LIGHT

Tipico lampadario a soffitto in arte povera a due luci, di piccole dimensioni.

TYPICAL COUNTRY LIFE STYLE DOUBLE CEILING PENDANT LIGHT, SMALL SIZE.

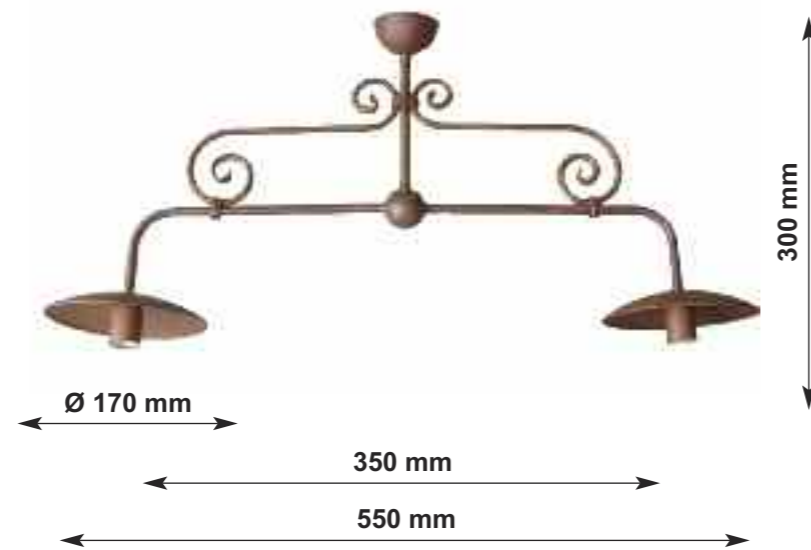

IP 20   
 max 40 W x 2  $\epsilon$  14   
 230 V 50 Hz



## Art. 5740

Applique

WALL LIGHT

Tipico lampioncino da parete in arte povera ad una luce, di piccole dimensioni, da interno o da esterno. Trasformabile in porta candele.

TYPICAL COUNTRY LIFE STYLE LAMP, SINGLE LIGHT, SMALL SIZE, FOR INTERIORS AND OUTDOOR. ON REQUEST IT CAN BE TURNED INTO A SCONCE.



## Art. 5750

Applique

WALL LIGHT

Tipico lampioncino da parete in arte povera a due luci, di piccole dimensioni, da interno o da esterno. Trasformabile in porta candele.

TYPICAL COUNTRY LIFE STYLE LAMP, TWIN LIGHT, SMALL SIZE, FOR INTERIORS AND OUTDOOR. ON REQUEST IT CAN BE TURNED INTO A SCONCE.



## Art. 5400

Abat Jour

TABLE LAMP

Abat jour in stile arte povera.

COUNTRY LIFE STYLE LAMP.

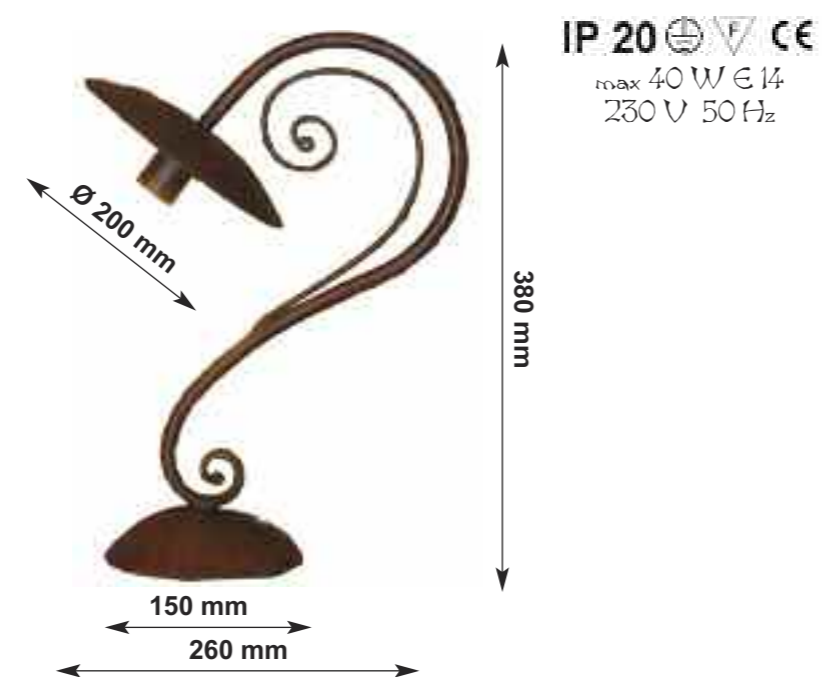

### Art. 5642

Applique  
WALL LIGHT

Tipico lampioncino da parete in arte povera ad una luce, di medie dimensioni, da interno o da esterno.

TYPICAL COUNTRY LIFE STYLE LAMP, SINGLE LIGHT, MEDIUM SIZE, FOR INTERIORS AND OUTDOOR.



### Art. 5644

Applique  
WALL LIGHT

Tipico lampioncino da parete in arte povera a due luci, di medie dimensioni, da interno o da esterno.

TYPICAL COUNTRY LIFE STYLE LAMP, TWIN LIGHT, MEDIUM SIZE, FOR INTERIORS AND OUTDOOR.



### Art. 5640

Applique  
WALL LIGHT

Tipico lampioncino da parete in arte povera ad una luce, di medie dimensioni, con piastra ad angolo. Da interno o da esterno.

TYPICAL COUNTRY LIFE STYLE LAMP, SINGLE LIGHT, MEDIUM SIZE, WITH EDGE BRACKETS. FOR INTERIORS AND OUTDOOR.

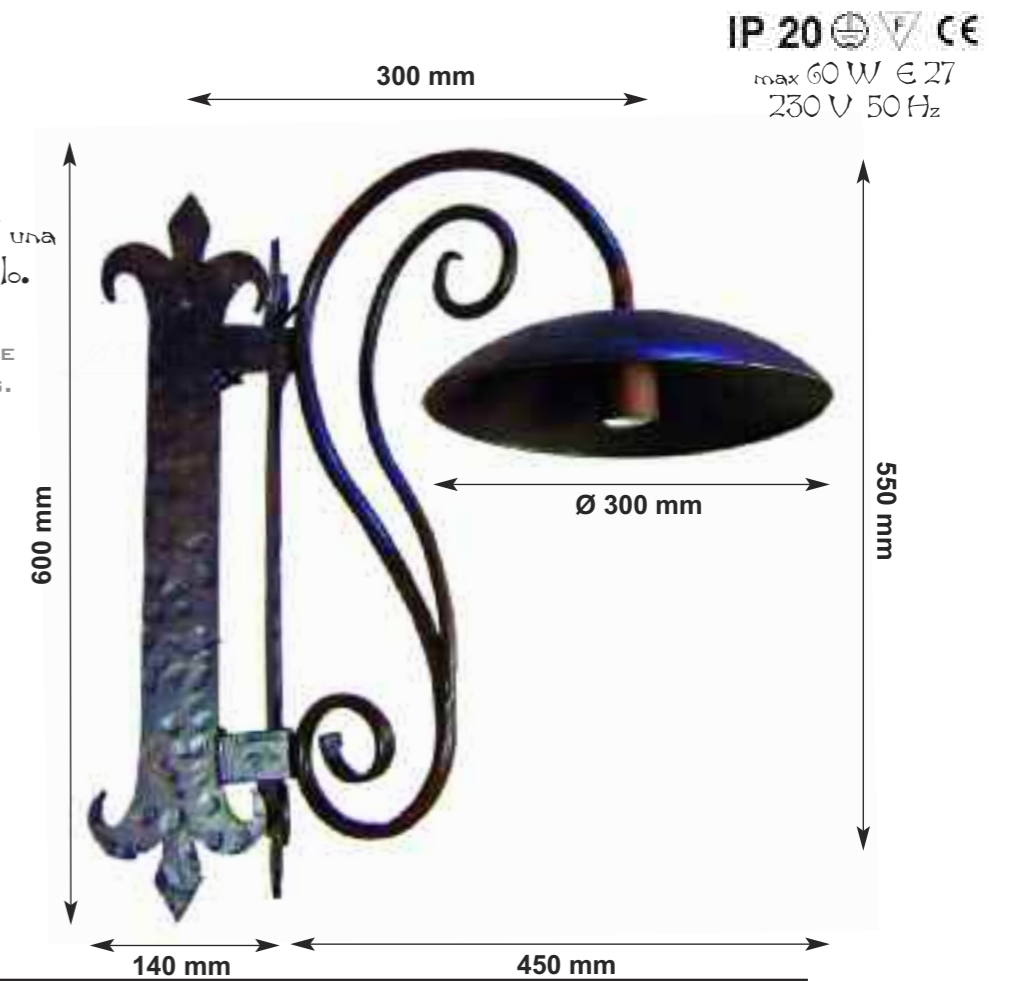

### Art. 5635

lampadario a soffitto  
CEILING PENDANT LIGHT

Tipico Lampadario in arte povera a tre luci, di medie dimensioni.

TYPICAL COUNTRY LIFE STYLE THREE LIGHT CHANDELIER, MEDIUM SIZE.



## Art. 5670

Lampione da Giardino

GARDEN LAMP POST

Tipico lampione da terra tradizionale da giardino ad una luce, realizzabile in qualsiasi altezza. Possono essere apportate delle modifiche per ottimizzare l'aspetto estetico.

CLASSIC STYLE SINGLE LIGHT LAMP POST. BESPOKE POLE HEIGHT ON REQUEST, MODIFICATIONS CAN BE MADE TO IMPROVE THE LOOK.



## Art. 5675

Lampione da Giardino

GARDEN LAMP POST

Tipico lampione da terra tradizionale da giardino a due luci, realizzabile in qualsiasi altezza. Possono essere apportate delle modifiche per ottimizzare l'aspetto estetico.

CLASSIC STYLE TWO ARM LIGHT LAMP POST. BESPOKE POLE HEIGHT ON REQUEST, MODIFICATIONS CAN BE MADE TO IMPROVE THE LOOK.



## Art. 5680

Lampione da Giardino

GARDEN LAMP POST

Tipico lampione da terra tradizionale da giardino a tre luci, realizzabile in qualsiasi altezza. Possono essere apportate delle modifiche per ottimizzare l'aspetto estetico.

CLASSIC STYLE THREE ARM LIGHT LAMP POST. BESPOKE POLE HEIGHT ON REQUEST, MODIFICATIONS CAN BE MADE TO IMPROVE THE LOOK.



## Art. 5645

Lampadario

CHANDELIER

Lampadario a tre livelli, 32 luci, con gocce di cristallo pendenti.  
Di gusto fine ed elegante, con bracci forgiati.  
Le sue importanti dimensioni la rendono adatta per soffitti alti, ambienti ampi e di prestigio, ristoranti e hall di albergo.

THREE TIER CHANDELIER, WITH 32 LIGHTS AND HANGING CRYSTAL DROPS.  
REFINED AND ELEGANT TASTE, WITH FORGED ARMS.  
ITS CONSIDERABLE DIMENSIONS ARE WELL SUITED TO HIGH CEILINGS, LARGE AND PRESTIGIOUS ROOMS, RESTAURANTS AND HOTEL HALLS.



IP 20   
max 60 W x 32 E 27  
230 V 50 Hz

## Art. 5646

Lampadario

CHANDELIER

Lampadario a tre livelli, 10 luci, con gocce di cristallo pendenti.  
Di gusto fine ed elegante, con bracci forgiati.

THREE TIER CHANDELIER, WITH 10 LIGHTS AND HANGING CRYSTAL DROPS.  
REFINED AND ELEGANT TASTE, WITH FORGED ARMS.

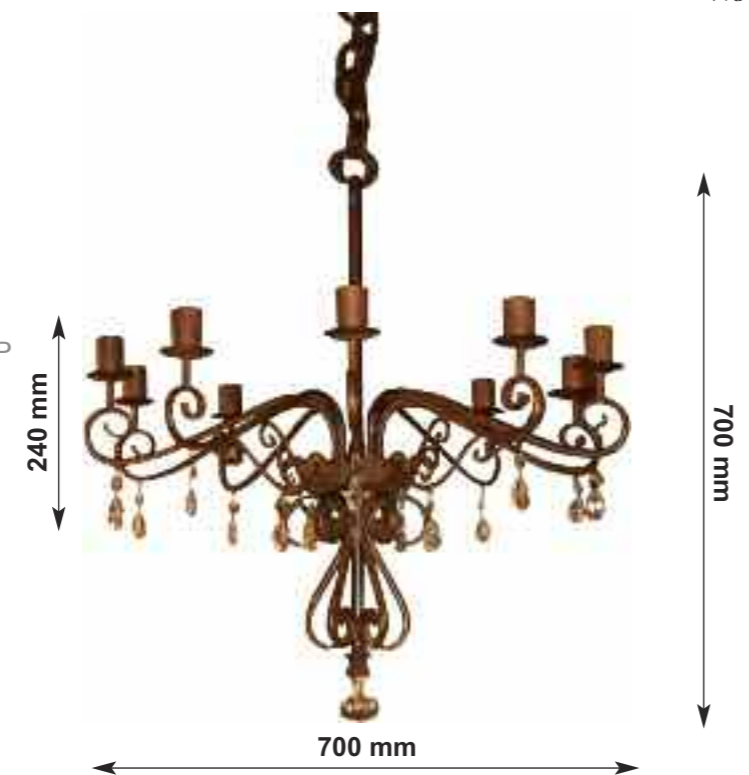

IP 20   
max 60 W x 10 E 27  
230 V 50 Hz





### Art. 6101

Applique  
WALL LIGHT

Lampada da parete di piccole dimensioni, ad una luce, in ottone trattato vecchio.

SMALL SIZE BRASS LAMP, SINGLE LIGHT, WITH AGEING FINISH.



### Art. 6106

Applique  
WALL LIGHT

Lampada da parete in ferro, di piccole dimensioni orientabile. Specifica da quadro o da specchiera con una luce interne.

IRON SWIVELING PICTURE LIGHT, SMALL SIZE, SINGLE LIGHT.



### Art. 6102

Applique  
WALL LIGHT

Lampada da parete di piccole dimensioni, ad due luci, in ottone trattato vecchio.

SMALL SIZE BRASS LAMP, TWIN LIGHT, WITH AGEING FINISH.

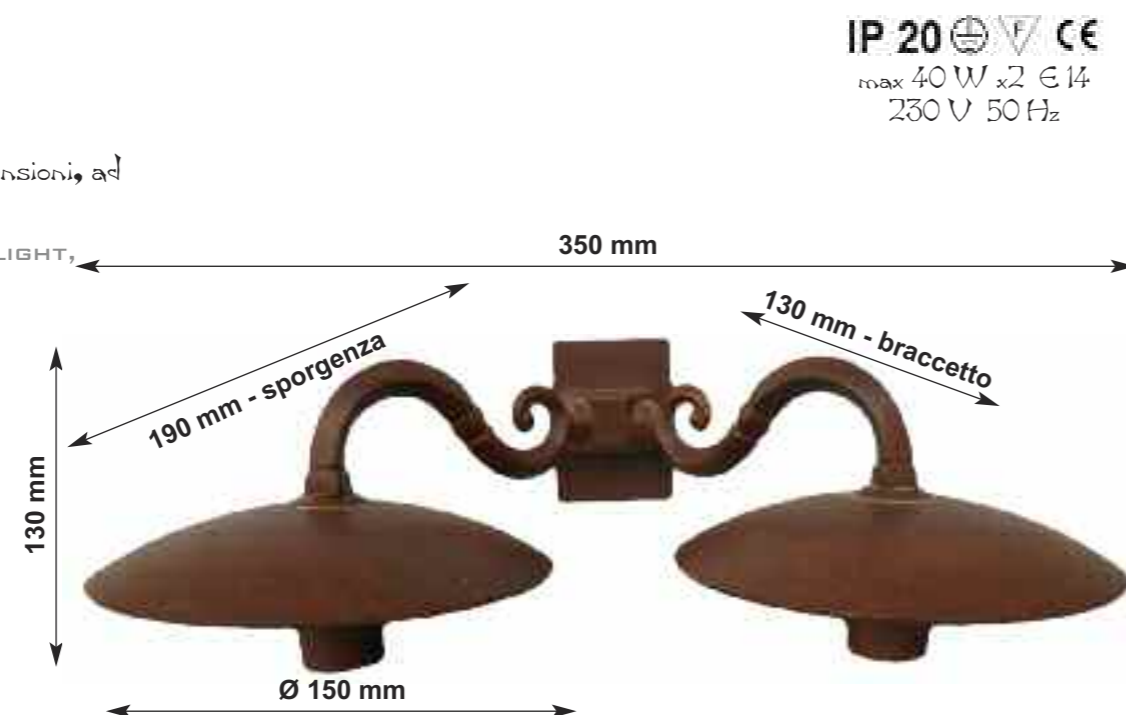

### Art. 6107

Applique  
WALL LIGHT

Lampada da parete in ferro, di piccole dimensioni orientabile. Specifica da quadro o da specchiera con due luci interne.

IRON SWIVELING PICTURE LIGHT, SMALL SIZE, TWO LIGHT.



### Art. 5649

WALL LIGHT

Lampada da parete di piccole dimensioni a chiocciola per esterno in fibra di nylon e vetro. WALL LAMP FOR SMALL OUTDOOR SPIRAL NYLON FIBER AND GLASS.



### Art. 611

Applique

WALL LIGHT

Lampada da parete di piccole dimensioni, ad una luce, in ottone trattato vecchio.

SMALL SIZE BRASS LAMP, SINGLE LIGHT, WITH AGEING FINISH.



IP 20 CE  
max 60 W E 27  
230 V 50 Hz

### Art. 612

Applique

WALL LIGHT

Lampada da parete di piccole dimensioni, ad due luci, in ottone trattato vecchio.

SMALL SIZE BRASS LAMP, TWIN LIGHT, WITH AGEING FINISH.



IP 20 CE  
max 60 W x2 E 27  
230 V 50 Hz

### Art. 616

Applique

WALL LIGHT

Lampada da parete di piccole dimensioni, ad una luce, in ottone trattato vecchio.

SMALL SIZE BRASS LAMP, SINGLE LIGHT, WITH AGEING FINISH.

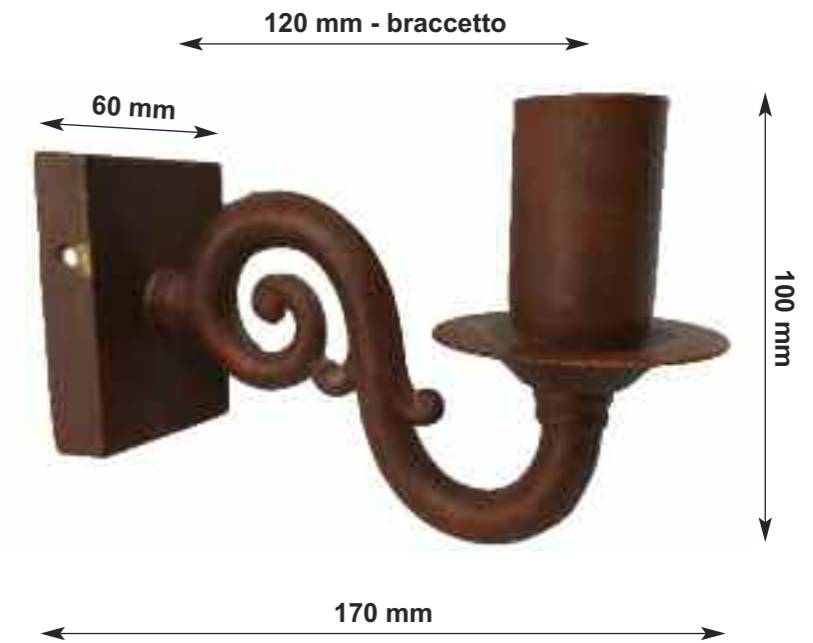

IP 20 CE  
max 40 W E 14  
230 V 50 Hz

### Art. 617

Applique

WALL LIGHT

Lampada da parete di piccole dimensioni, ad due luci, in ottone trattato vecchio.

SMALL SIZE BRASS LAMP, TWIN LIGHT, WITH AGEING FINISH.



IP 20 CE  
max 40 W x2 E 14  
230 V 50 Hz

## Art. 6000

Lampada da Parete

WALL LIGHT

Lampione in arte povera di medie dimensioni per uso esterno.

COUNTRY LIFE STYLE LAMP, MEDIUM SIZE FOR OUTDOOR.



IP 20   
 max 60 W E 27   
 230 V 50 Hz



## Art. 6005

Lampada da Parete

WALL LIGHT

Lampione in arte povera di grandi dimensioni per uso esterno.

COUNTRY LIFE STYLE LAMP, BIG SIZE FOR OUTDOOR.

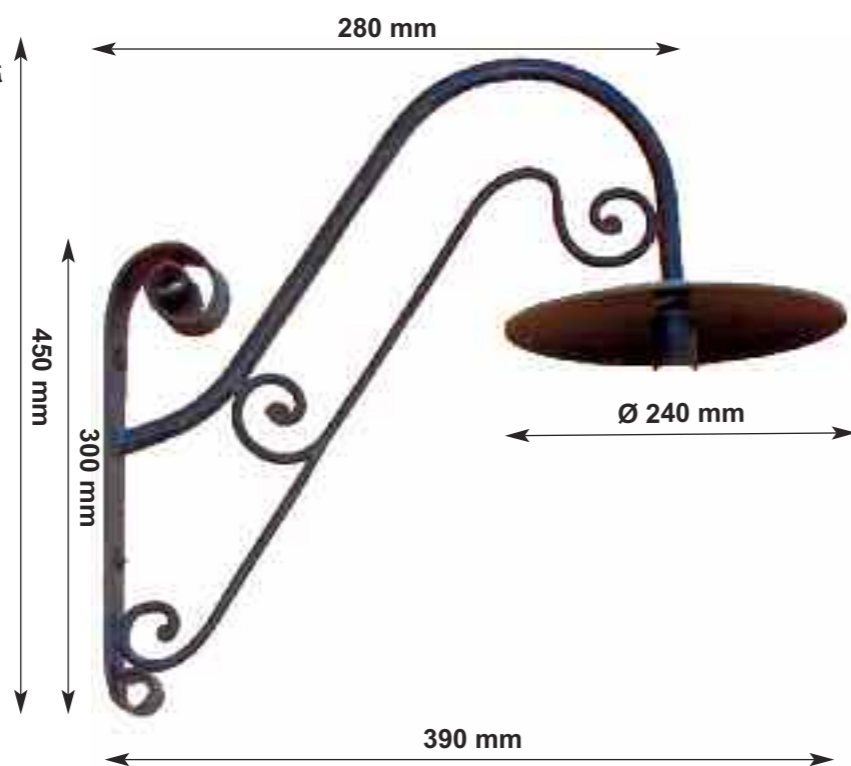

IP 20   
 max 60 W E 27   
 230 V 50 Hz



### Art. 6011

Lampada da Parete

WALL LIGHT

Lampione in arte povera di medie dimensioni per uso esterno.

COUNTRY LIFE STYLE LAMP, MEDIUM SIZE FOR OUTDOOR.

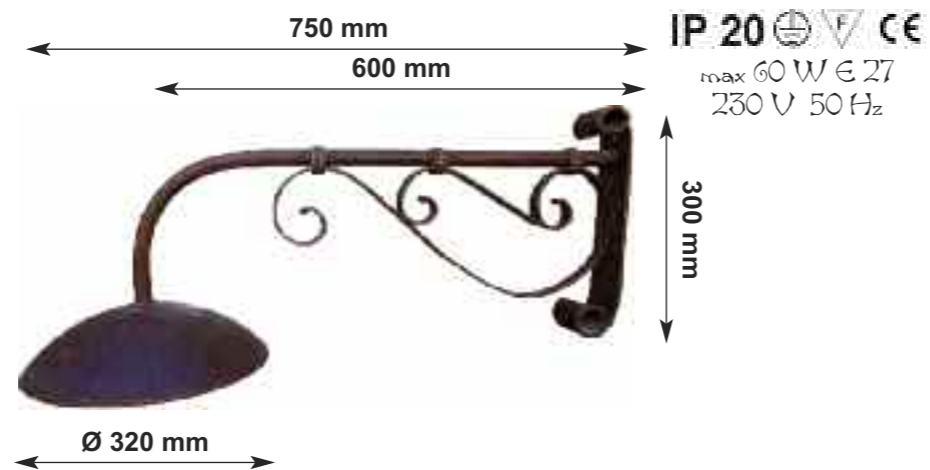

### Art. 6013

Lampada da Parete a spigolo

WALL LIGHT

Lampione per spigolo in arte povera di medie dimensioni per uso esterno.

COUNTRY LIFE STYLE LAMP WITH EDGE BRACKETS, MEDIUM SIZE FOR OUTDOOR.

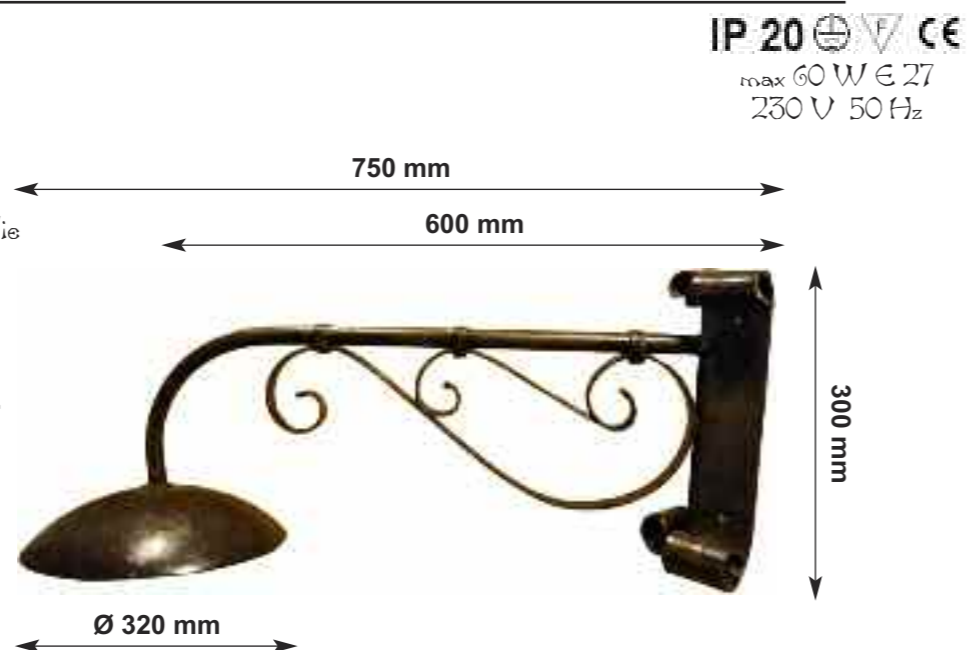

### Art. 6015

Lampada da Parete a spigolo

WALL LIGHT

Lampione per spigolo in arte povera di medie dimensioni per uso esterno.

COUNTRY LIFE STYLE LAMP WITH EDGE BRACKETS, MEDIUM SIZE FOR OUTDOOR.



### Art. 6025

Lampada da Parete  
WALL LIGHT

Lampione da esterno in arte povera, di grandi dimensioni per uso esterno.

COUNTRY LIFE STYLE LAMP WITH BRACKETS,  
BIG SIZE, FOR OUTDOOR.



IP 20   
max 60 W E 27  
230 V 50 Hz



### Art. 6030

Lampada da Parete  
WALL LIGHT

Lampioncino in arte povera, di piccole dimensioni per uso interno.

COUNTRY LIFE STYLE LAMP WITH BRACKETS,  
SMALL SIZE, FOR INTERIORS.

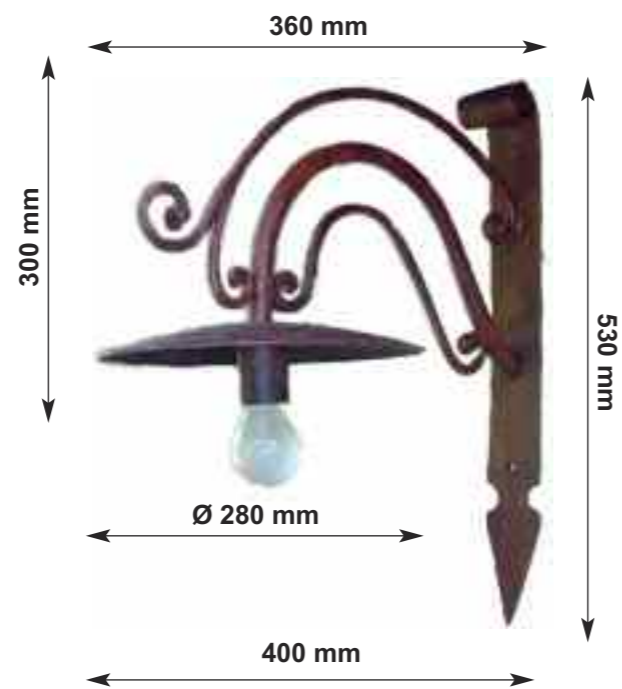

IP 20   
max 60 W E 27  
230 V 50 Hz



### Art. 5220

Lampadario  
CEILING PENDANT LIGHT

Lampada sospensione in stile arte povera.

COUNTRY LIFE STYLE CEILING PENDANT LIGHT.



IP 20   
max 60 W E 27  
230 V 50 Hz

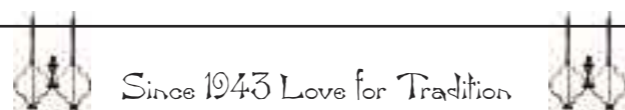

# Art. 6050

## Lampione Stradale

STREET LAMP

Lampione per illuminazione stradale, realizzata con piatto 35cm.

35 CM PLATE STREET LAMP.

Sottoborchia in acciaio smaltato bianco.

WITH ENAMELLED STEEL PLATE UNDERNEATH.

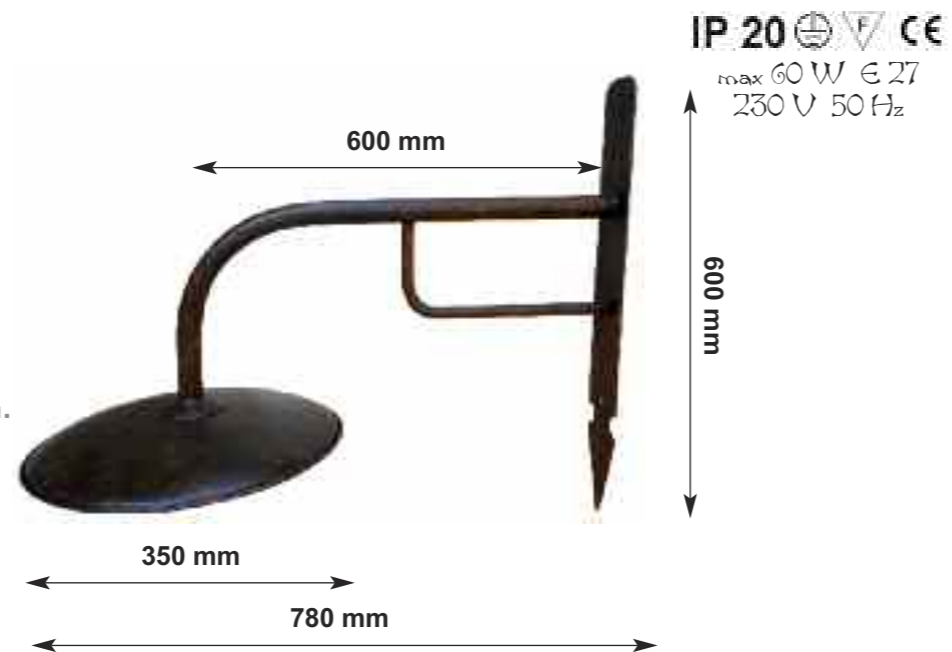

# Art. 6051

## Lampione Stradale

STREET LAMP

Lampione per illuminazione stradale, realizzata con piatto 40cm.

40 CM PLATE STREET LAMP.

Sottoborchia in acciaio smaltato bianco.

WITH ENAMELLED STEEL PLATE UNDERNEATH.

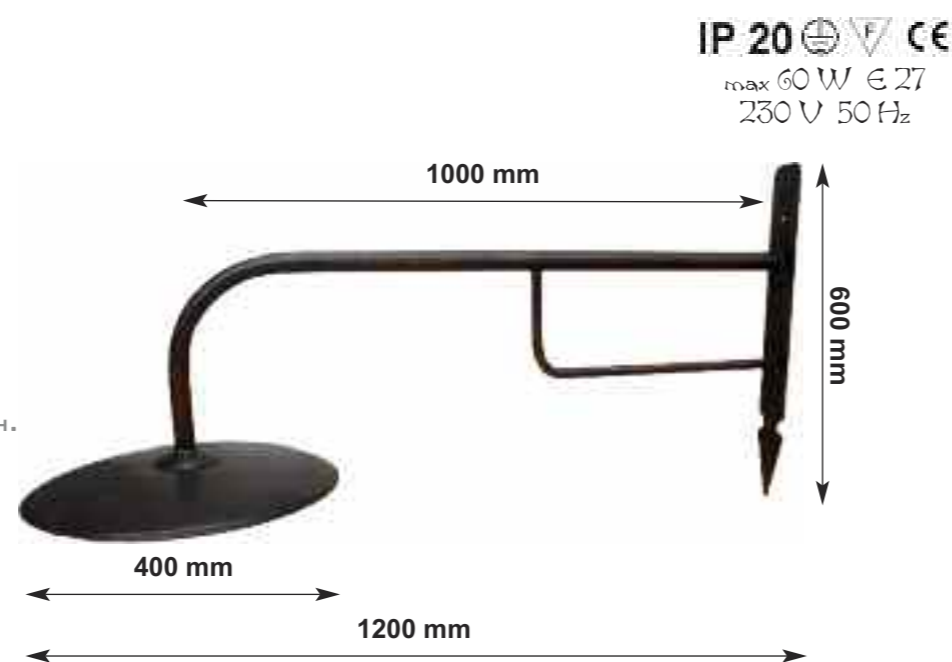

## Art. 5140

Lampadario  
CEILING PENDANT LIGHT

Lampada sospensione a tre luci, stile arte povera.

THREE LIGHT COUNTRY LIFE STYLE PLAIN  
CEILING PENDANT LAMP.

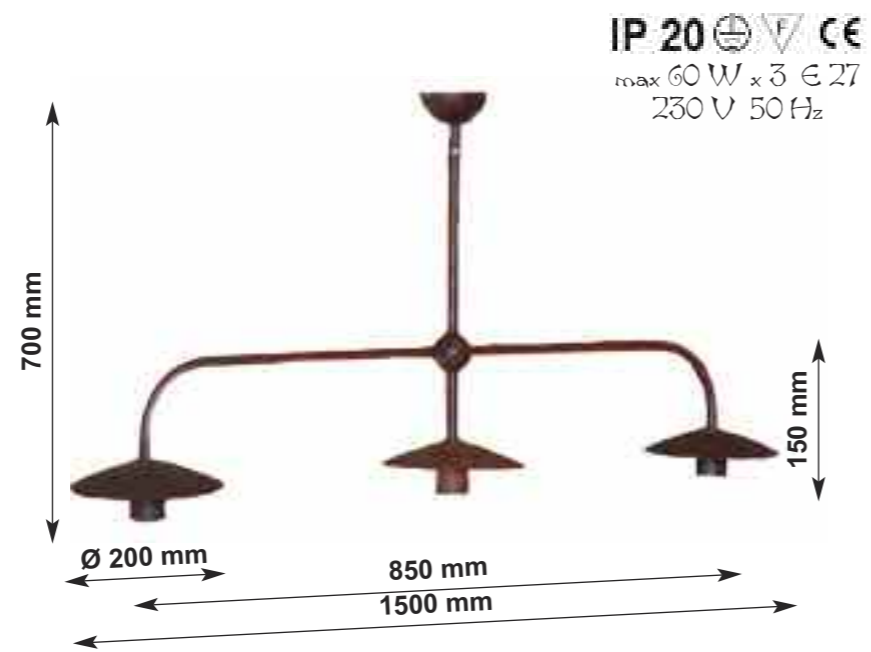

IP 20 CE  
max 60 W x 3 E 27  
230 V 50 Hz

## Art. 5130

Lampadario  
CEILING PENDANT LIGHT

Lampada sospensione a due luci, stile arte povera.

TWO LIGHT COUNTRY LIFE STYLE PLAIN  
CEILING PENDANT LAMP.



IP 20 CE  
max 60 W x 2 E 27  
230 V 50 Hz

## Art. 5120

Lampadario  
CEILING PENDANT LIGHT

Lampada sospensione a una luce, stile arte povera.

SINGLE LIGHT COUNTRY LIFE STYLE PLAIN  
STYLE CEILING PENDANT LAMP.



IP 20 CE  
max 60 W E 27  
230 V 50 Hz



## Art. 5141

Lampadario  
CEILING PENDANT LIGHT

Lampada a Tre Luci con ricci decorativi.  
Stile arte povera.

THREE LIGHT COUNTRY LIFE STYLE  
CEILING PENDANT LAMP WITH DECORATIVE  
CURLS.

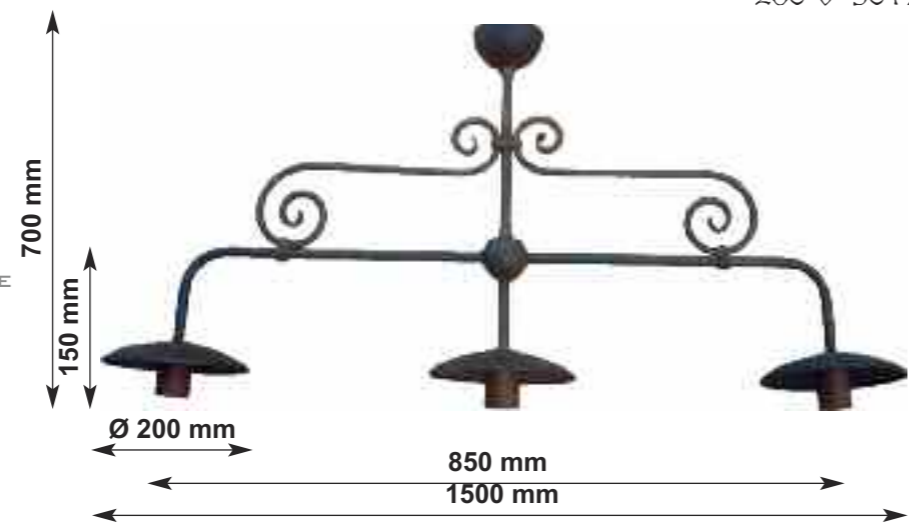

IP 20 CE  
max 40 W x 3 E 14  
230 V 50 Hz

## Art. 5131

Lampadario  
CEILING PENDANT LIGHT

Lampada a due luci con ricci decorativi, di  
medie dimensioni.  
Stile arte povera.

TWO LIGHT COUNTRY LIFE STYLE  
CEILING PENDANT LAMP WITH DECORATIVE  
CURLS, MEDIUM SIZE.

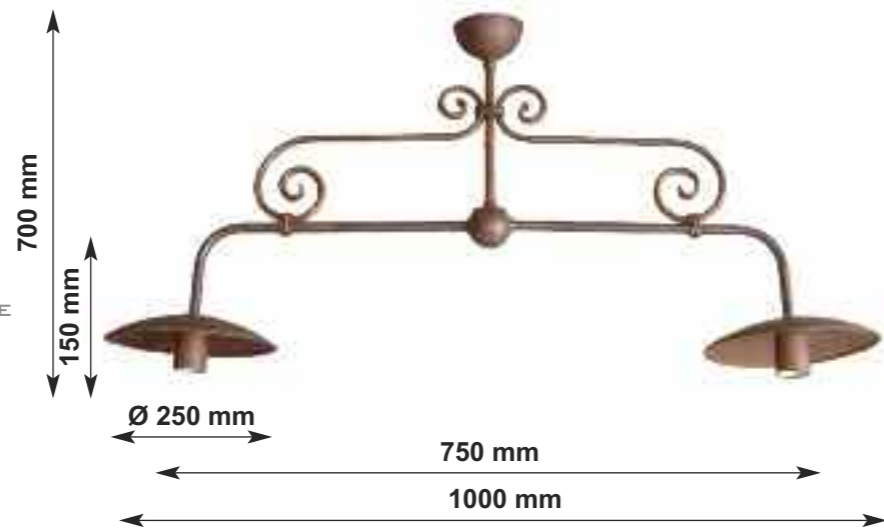

IP 20 CE  
max 40 W x 2 E 14  
230 V 50 Hz

## Art. 5100

Lampadario  
CEILING PENDANT LIGHT

Lampada a due luci con ricci decorativi, di  
piccole dimensioni.  
Stile arte povera.

TWO LIGHT COUNTRY LIFE STYLE  
CEILING PENDANT LAMP WITH DECORATIVE  
CURLS, SMALL SIZE.



IP 20 CE  
max 40 W E 14  
230 V 50 Hz





### Art. 5150

Lampadario  
CHANDELIER

Lampadario sospensione a sei luci in stile arte povera.

SIX LIGHT COUNTRY LIFE STYLE PLAIN CHANDELIER.

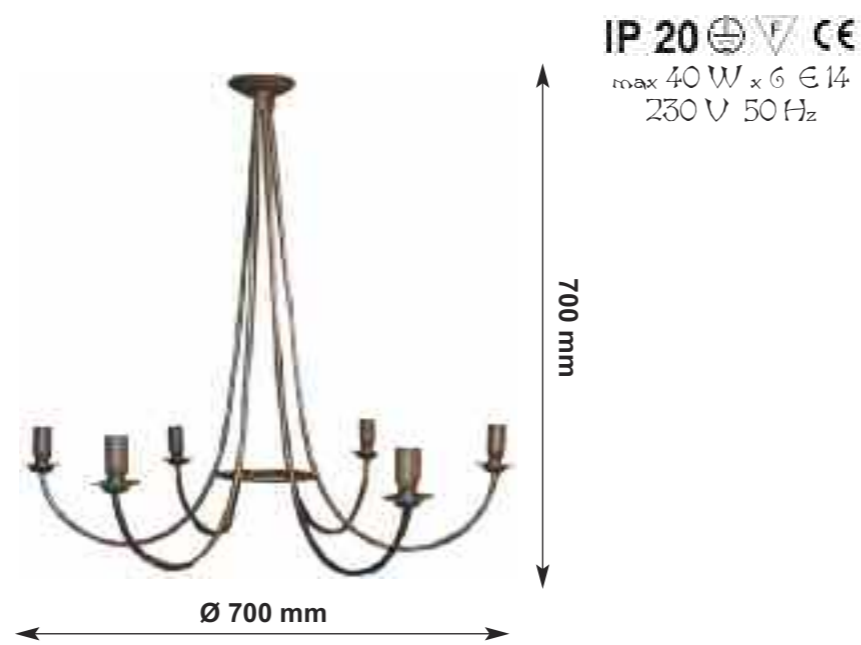

### Art. 5155

Lampadario  
CHANDELIER

Lampadario a sospensione a sei luci, con foglie forgiate avvolte intorno allo stelo della lampada. Con campane in vetro di Murano (art. 2621)

SIX LIGHT CHANDELIER WITH FORGED WRAPPED LEAVES DECORATION. MURANO GLASS BELL JARS.

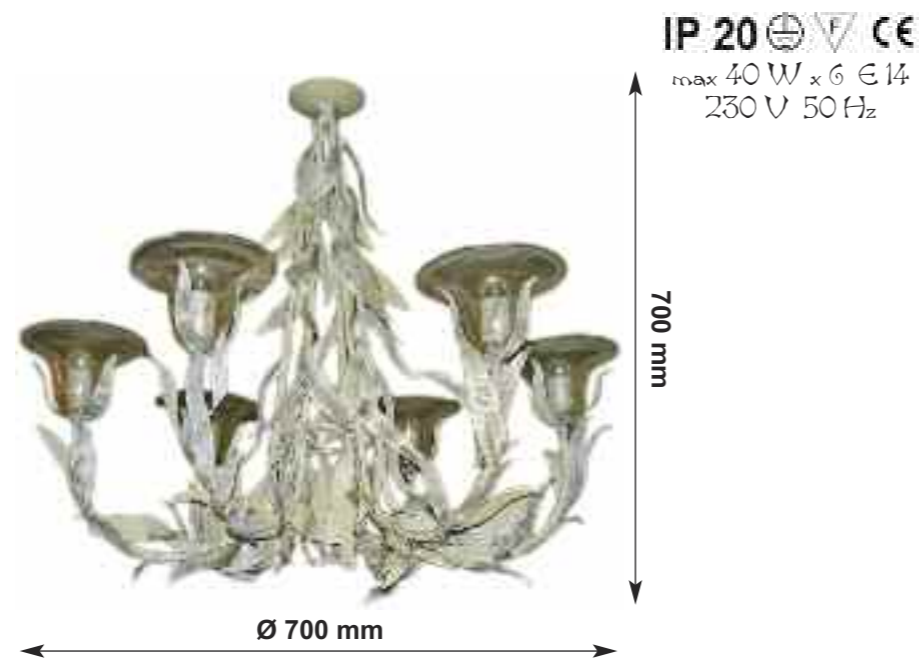

### Art. 5151

Lampadario  
CHANDELIER

Lampadario sospensione a quattro luci in stile arte povera.

FOUR LIGHT COUNTRY LIFE STYLE PLAIN CHANDELIER.

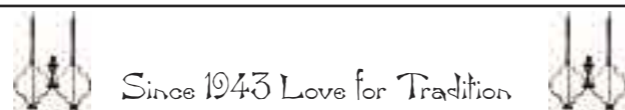

Since 1943 Love for Tradition

# Lampade in tessuto

## FABRIC LAMPSHADES



Canapa grezza  
RAW HEMP

con decoro e bordo  
in canapa

WITH GARNISH AND  
HEMP TRIMMING



Cotone  
COTTON

con bordo  
ricamato

WITH COTTON TRIMMING



Misto lino  
LINEN BLEND

con decoro e bordo  
ricamato

WITH EMBROIDERY AND  
TRIMMING



# Paralumi in canapa grezza con decoro e bordo in canapa

## Art. 5411

Abat Jour

TABLE LAMP

Abat Jour in stile arte povera con paralume in tessuto di canapa. usare lampadine a basso consumo

COUNTRY LIFE STYLE LAMP WITH HEMP LAMPSHADE. USE LOW ENERGY LIGHT BULBS



IP 20 CE  
max 40 W E14  
230 V 50 Hz



## Art. 5414

Abat Jour

TABLE LAMP

Abat Jour in stile arte povera con paralume in tessuto di canapa. usare lampadine a basso consumo

COUNTRY LIFE STYLE LAMP WITH HEMP LAMPSHADE. USE LOW ENERGY LIGHT BULBS

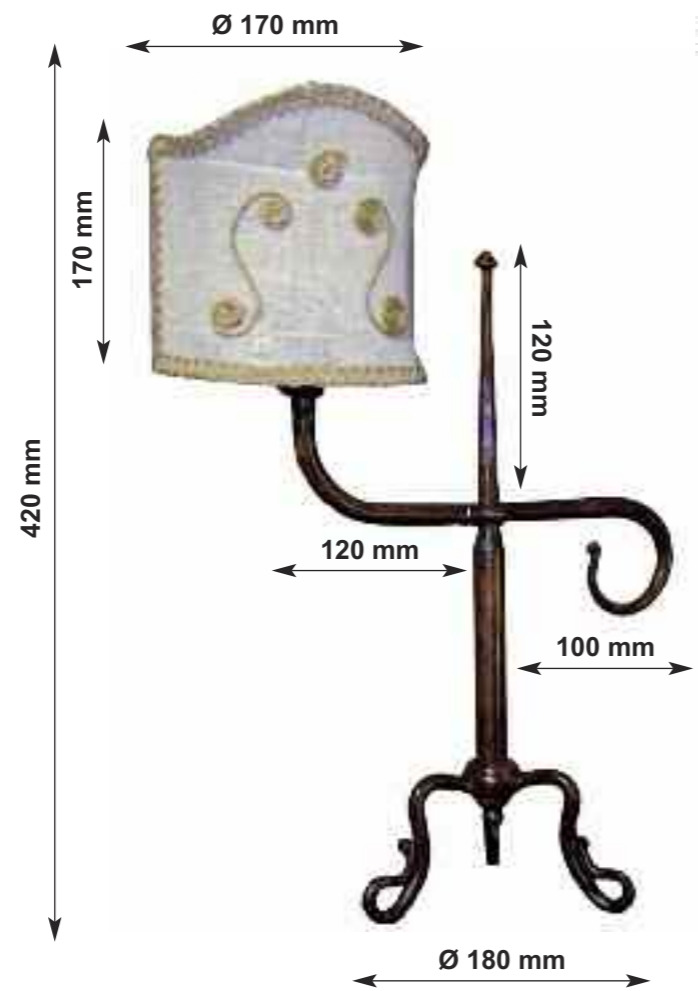

IP 20 CE  
max 40 W E14  
230 V 50 Hz



# Paralumi in misto lino con decoro e bordo ricamato

## Art. 5885

Abat Jour  
TABLE LAMP

Abat Jour in stile arte povera con paralume in tessuto di canapa.  
usare lampadine a basso consumo

COUNTRY LIFE STYLE LAMP WITH HEMP LAMPSHADE.  
USE LOW ENERGY LIGHT BULBS



IP 20 CE  
max 40 W E 14  
230 V 50 Hz

## Art. 5886

Abat Jour  
TABLE LAMP

Abat Jour in stile arte povera con paralume in tessuto di canapa.  
usare lampadine a basso consumo

COUNTRY LIFE STYLE LAMP WITH HEMP LAMPSHADE.  
USE LOW ENERGY LIGHT BULBS



IP 20 CE  
max 40 W E 14  
230 V 50 Hz



### Art. 1068

Lampada da soffitto

CEILING PENDANT LIGHT

Lampada in stile arte povera con paralume in tessuto di canapa.

usare lampadine a basso consumo

COUNTRY LIFE STYLE LAMP WITH HEMP LAMPSHADE.

USE LOW ENERGY LIGHT BULBS



IP 20   
 max 40 W E 27   
 230 V 50 Hz

### Art. 1067

Appliques

WALL LIGHT

Lampada in stile arte povera con paralume in tessuto di canapa.

usare lampadine a basso consumo

COUNTRY LIFE STYLE LAMP WITH HEMP LAMPSHADE.

USE LOW ENERGY LIGHT BULBS



IP 20   
 max 40 W E 14   
 230 V 50 Hz

### Art. 1062

Lampada da Terra

FLOOR LAMP

Lampada in stile arte povera con paralume in tessuto di canapa.

usare lampadine a basso consumo

COUNTRY LIFE STYLE LAMP WITH HEMP LAMPSHADE.

USE LOW ENERGY LIGHT BULBS

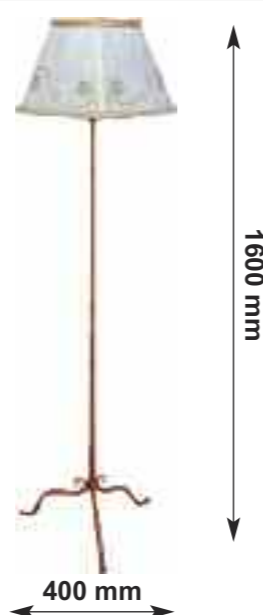

IP 20   
 max 40 W E 27   
 230 V 50 Hz

### Art. 1064

Abat-jour

TABLE LAMP

Lampada in stile arte povera con paralume in tessuto di canapa.

usare lampadine a basso consumo

COUNTRY LIFE STYLE LAMP WITH HEMP LAMPSHADE.

USE LOW ENERGY LIGHT BULBS



IP 20   
 max 40 W E 14   
 230 V 50 Hz



Since 1943 Love for Tradition

### Art. 1066

Appliques  
WALL LIGHT

Lampada in stile arte povera con paralume in tessuto di canapa. usare lampadine a basso consumo

COUNTRY LIFE STYLE LAMP WITH HEMP LAMPSHADE.  
USE LOW ENERGY LIGHT BULBS



IP 20 CE  
max 40 W E 14  
230 V 50 Hz

### Art. 1065

Abat-jour  
TABLE LAMP

Lampada in stile arte povera con paralume in tessuto di canapa. usare lampadine a basso consumo

COUNTRY LIFE STYLE LAMP WITH HEMP LAMPSHADE.  
USE LOW ENERGY LIGHT BULBS



IP 20 CE  
max 40 W E 14  
230 V 50 Hz

### Art. 1063

Lampada da Terra  
FLOOR LAMP

Lampada in stile arte povera con paralume in tessuto di canapa. usare lampadine a basso consumo

COUNTRY LIFE STYLE LAMP WITH HEMP LAMPSHADE.  
USE LOW ENERGY LIGHT BULBS

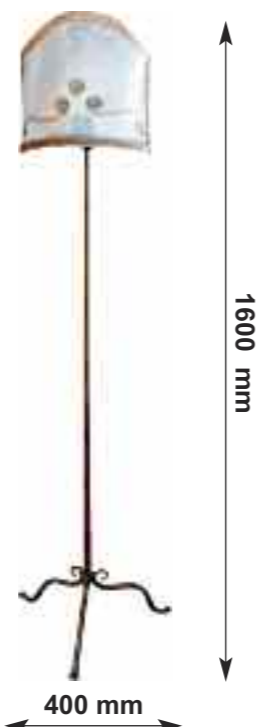

IP 20 CE  
max 40 W E 27  
230 V 50 Hz



### Art. 2052

Lampada da soffitto

CEILING PENDANT LIGHT

Lampada in stile arte povera con paralume in cotone con bordo in passamaneria.

usare lampadine a basso consumo

COUNTRY LIFE STYLE LAMP WITH COTTON LAMPSHADE AND COTTON TRIMMING.

USE LOW ENERGY LIGHT BULBS



IP 20   
 max 40 W E 27   
 230 V 50 Hz

### Art. 2050

Applique

WALL LIGHT

Applique in stile arte povera con paralume in cotone con bordo in passamaneria.

usare lampadine a basso consumo

COUNTRY LIFE STYLE LAMP WITH COTTON LAMPSHADE AND COTTON TRIMMING.

USE LOW ENERGY LIGHT BULBS



IP 20   
 max 40 W E 14   
 230 V 50 Hz

A - Con ceramica in bianco   
 WHITE CERAMIC

B - Con ceramica in avorio   
 IVORY CERAMIC

### Art. 2040

Lampada da Terra

FLOOR LAMP

Lampada in stile arte povera con paralume in cotone con bordo in passamaneria.

usare lampadine a basso consumo

COUNTRY LIFE STYLE LAMP WITH COTTON LAMPSHADE AND COTTON TRIMMING.

USE LOW ENERGY LIGHT BULBS

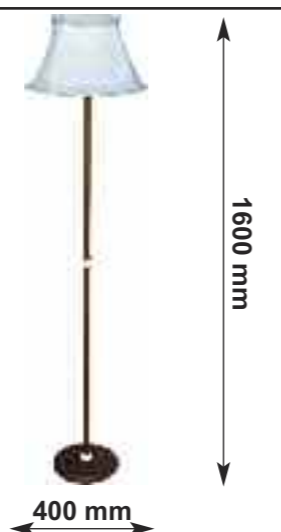

IP 20   
 max 40 W E 27   
 230 V 50 Hz

A - Con ceramica in bianco   
 WHITE CERAMIC

B - Con ceramica in avorio   
 IVORY CERAMIC

### Art. 2045

Abat-jour

TABLE LAMP

Lampada in stile arte povera con paralume in cotone con bordo in passamaneria.

usare lampadine a basso consumo

COUNTRY LIFE STYLE LAMP WITH COTTON LAMPSHADE AND COTTON TRIMMING.

USE LOW ENERGY LIGHT BULBS



IP 20   
 max 40 W E 14   
 230 V 50 Hz

A - Con ceramica in bianco   
 WHITE CERAMIC

B - Con ceramica in avorio   
 IVORY CERAMIC



### Art. 2051

Applique  
WALL LIGHT

Applique in stile arte povera con paralume in cotone con bordo in passamaneria.

usare lampadine a basso consumo

COUNTRY LIFE STYLE LAMP WITH COTTON LAMPSHADE AND COTTON TRIMMING.

USE LOW ENERGY LIGHT BULBS

A - Con ceramica in bianco  
WHITE CERAMIC



B - Con ceramica in avorio  
IVORY CERAMIC



IP 20 CE  
max 40 W E14  
230 V 50 Hz

### Art. 2046

Abat-jour  
TABLE LAMP

Lampada in stile arte povera con paralume in cotone con bordo in passamaneria.

usare lampadine a basso consumo

COUNTRY LIFE STYLE LAMP WITH COTTON LAMPSHADE AND COTTON TRIMMING.

USE LOW ENERGY LIGHT BULBS

A - Con ceramica in bianco  
WHITE CERAMIC



B - Con ceramica in avorio  
IVORY CERAMIC



IP 20 CE  
max 40 W E14  
230 V 50 Hz

### Art. 2041

Lampada da Terra  
FLOOR LAMP

Lampada in stile arte povera con paralume in cotone con bordo in passamaneria.

usare lampadine a basso consumo

COUNTRY LIFE STYLE LAMP WITH COTTON LAMPSHADE AND COTTON TRIMMING.

USE LOW ENERGY LIGHT BULBS

A - Con ceramica in bianco  
WHITE CERAMIC



B - Con ceramica in avorio  
IVORY CERAMIC

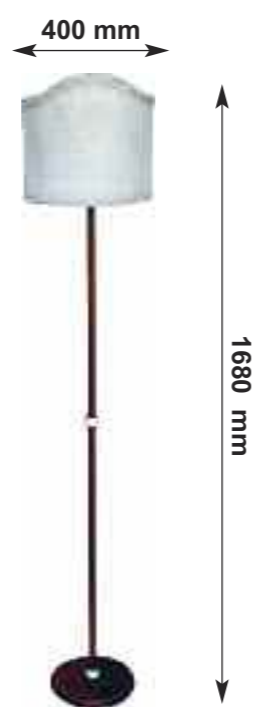

IP 20 CE  
max 40 W E27  
230 V 50 Hz





# Paralumi in misto lino con decoro e bordo ricamato

## Art. 3040

Lampada da soffitto

CEILING PENDANT LIGHT

Lampada in stile arte povera con paralume in misto lino ricamato.

usare lampadine a basso consumo

COUNTRY LIFE STYLE LAMP WITH LINEN BLEND LAMPSHADE AND EMBROIDERY.

USE LOW ENERGY LIGHT BULBS



IP 20 max 40 W E 27 230 V 50 Hz

## Art. 3037

Applique

WALL LIGHT

Lampada in stile arte povera con paralume in misto lino ricamato.

usare lampadine a basso consumo

COUNTRY LIFE STYLE LAMP WITH LINEN BLEND LAMPSHADE AND EMBROIDERY.

USE LOW ENERGY LIGHT BULBS



IP 20 max 40 W E 14 230 V 50 Hz

## Art. 3034

Lampada da Terra

FLOOR LAMP

Lampada in stile arte povera con paralume in misto lino ricamato e base in ceramica.

usare lampadine a basso consumo

COUNTRY LIFE STYLE LAMP WITH LINEN BLEND LAMPSHADE AND EMBROIDERY.

CERAMIC PEDESTAL.

USE LOW ENERGY LIGHT BULBS

A - Con ceramica in bianco  
WHITE CERAMIC

B - Con ceramica in avorio  
IVORY CERAMIC

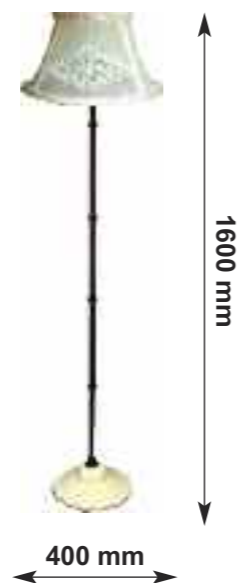

IP 20 max 40 W E 27 230 V 50 Hz

## Art. 3038

Abat-jour

TABLE LAMP

Lampada in stile arte povera con paralume in misto lino ricamato.

usare lampadine a basso consumo

COUNTRY LIFE STYLE LAMP WITH LINEN BLEND LAMPSHADE AND EMBROIDERY.

USE LOW ENERGY LIGHT BULBS



IP 20 max 40 W E 14 230 V 50 Hz



Since 1943 Love for Tradition

www.armoniedepoca.com

# Paralumi in misto lino con decoro e bordo ricamato

## Art. 3036

Appliques  
WALL LAMP

Lampada in stile arte povera con paralume in misto lino ricamato.

usare lampadine a basso consumo

COUNTRY LIFE STYLE LAMP WITH LINEN BLEND LAMPSHADE AND EMBROIDERY.  
USE LOW ENERGY LIGHT BULBS



IP 20   
max 40 W E14  
230 V 50 Hz

## Art. 3039

Abat-jour  
TABLE LAMP

Lampada in stile arte povera con paralume in misto lino ricamato.

usare lampadine a basso consumo

COUNTRY LIFE STYLE LAMP WITH LINEN BLEND LAMPSHADE AND EMBROIDERY.  
USE LOW ENERGY LIGHT BULBS



IP 20   
max 40 W E14  
230 V 50 Hz

## Art. 3035

Lampada da Terra  
FLOOR LAMP

Lampada in stile arte povera con paralume in misto lino ricamato e base in ceramica.

usare lampadine a basso consumo

COUNTRY LIFE STYLE LAMP WITH LINEN BLEND LAMPSHADE AND EMBROIDERY.  
CERAMIC PEDESTAL.  
USE LOW ENERGY LIGHT BULBS



IP 20   
max 40 W E27  
230 V 50 Hz

- A - Con ceramica in bianco  
WITH CERAMIC
- B - Con ceramica in avorio  
IVORY CERAMIC



## Art. 6420

Lampada da tavolo

TABLE LAMP

Lampada con base svasata di lavorazione in lamiera ritagliata martellata con ribattini e angolari in stile industriale.

Paralume in corda intrecciata a mano.

usare lampadine a basso consumo

FLARED PEDESTAL INDUSTRIAL STYLE LAMP, WITH HAMMERED IRON SHEET AND RIVETS. WOVEN BY HAND SHADE.

USE LOW ENERGY LIGHT BULBS

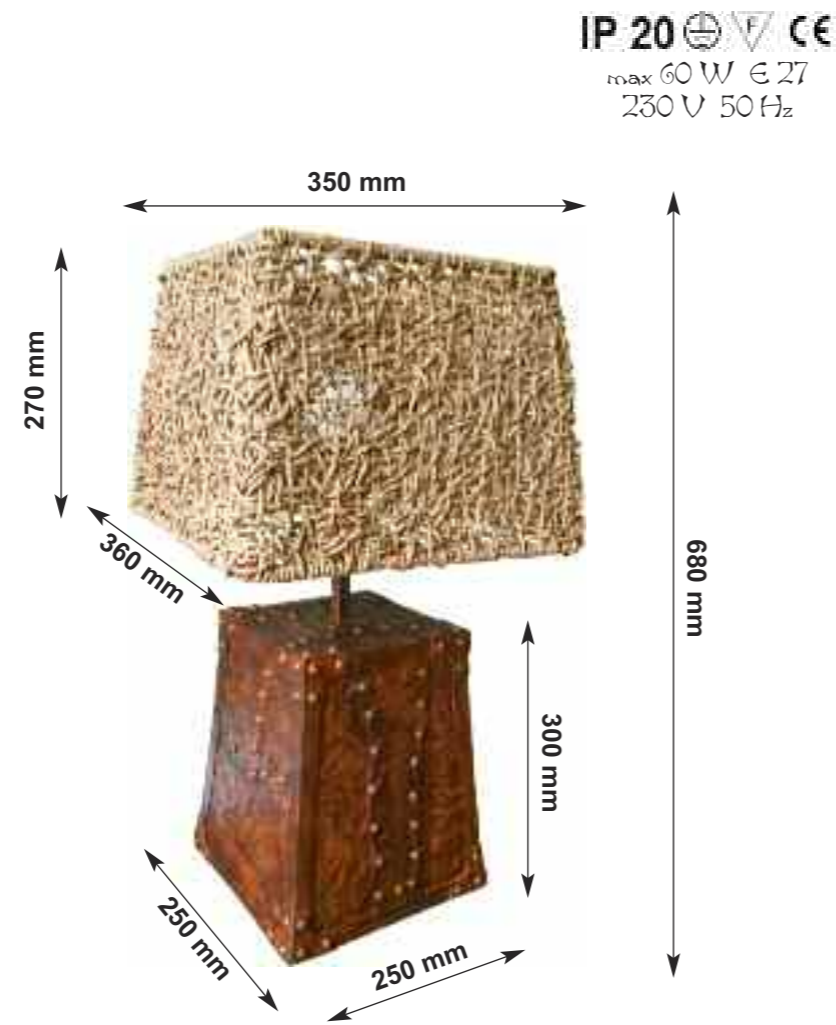

IP 20

max 60 W E 27  
230 V 50 Hz

## Art. 6421

Lampada da tavolo

TABLE LAMP

Lampada di lavorazione in lamiera ritagliata martellata con ribattini e angolari in stile industriale.

Paralume in corda intrecciata a mano.

usare lampadine a basso consumo

INDUSTRIAL STYLE LAMP, WITH HAMMERED IRON SHEET AND RIVETS. WOVEN BY HAND SHADE.

USE LOW ENERGY LIGHT BULBS

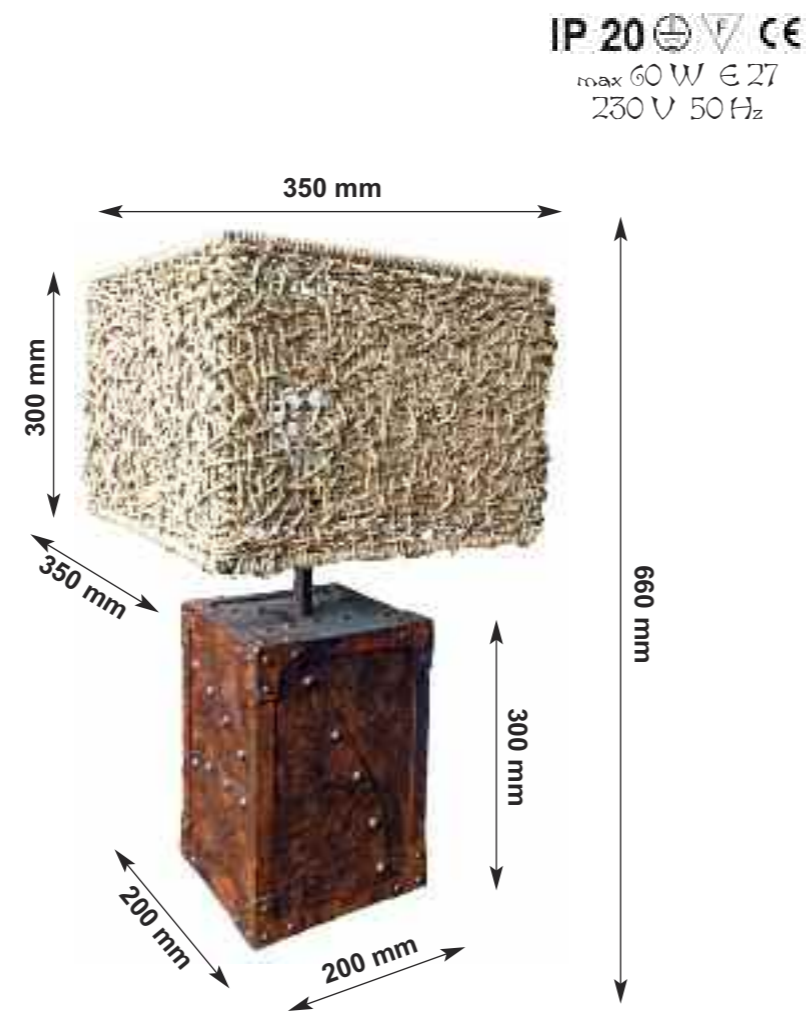

IP 20

max 60 W E 27  
230 V 50 Hz



# Lampade in ceramica

## CERAMIC LAMPSHADES



WITH THE SMOOTH CERAMIC

Ceramica  
bianca  
liscia



IVORY SMOOTH CERAMIC

Ceramica  
avorio  
liscia



WHITE WAVY CERAMIC

Ceramica  
bianca  
smerlata



IVORY WAVY CERAMIC

Ceramica  
avorio  
smerlata



Lampade con paralumi in *ceramica bianca liscia*

**Art. 5045**

Applique  
piatto stretto

WALL LIGHT  
BELL-SHAPED SHADE



**Art. 5044**

Applique  
piatto largo

WALL LIGHT  
SMOOTH PLATE



IP 20   
max 40 W E 14  
230 V 50 Hz

**Art. 5076**

Applique  
piatto stretto

WALL LIGHT  
BELL-SHAPED SHADE



**Art. 5074**

Applique  
piatto largo

WALL LIGHT  
SMOOTH PLATE



IP 20   
max 40 W E 14  
230 V 50 Hz

**Art. 5034**

Applique  
piatto stretto

WALL LIGHT  
BELL-SHAPED SHADE



**Art. 5035**

Applique  
piatto largo

WALL LIGHT  
SMOOTH PLATE



IP 20   
max 40 W E 14  
230 V 50 Hz

**Art. 5880**

Applique

WALL LAMP

stile arte povera con foglie di ferro forgiate a mano, avvolte allo stelo della lampada.  
Campana in ceramica bianco liscio.

COUNTRY LIFE STYLE LAMP, WITH IRON HAND FORGED TWISTED LEAVES.  
SMOOTH WHITE CERAMIC BELL-SHAPED SHADE.



IP 20   
max 40 W E 14  
230 V 50 Hz



Since 1943 Love for Tradition



**Art. 5071 A**

Lampadario con contrappeso sali scendi in ceramica, con piatto grande bianco liscio.

CEILING PENDANT LIGHT WITH BIG SIZE SMOOTH WHITE CERAMIC PLATE AND COUNTERWEIGHT.

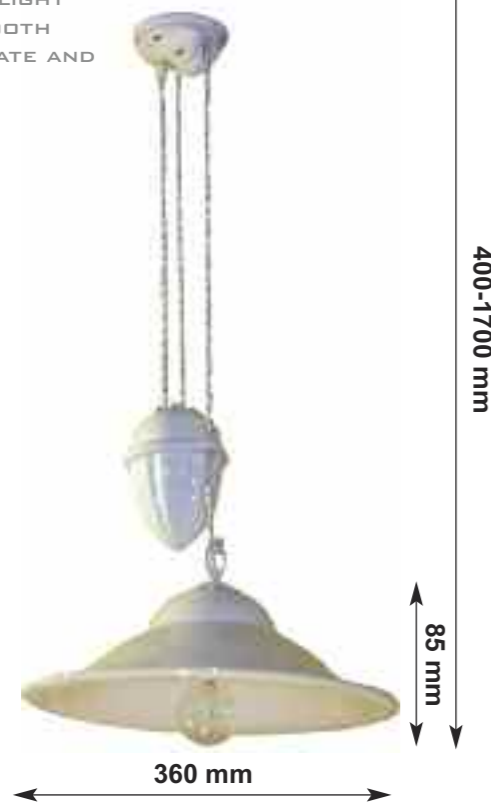

**Art. 5071**

Lampadario con piatto grande  
CEILING PENDANT LIGHT  
BIG SIZE SMOOTH WHITE PLATE

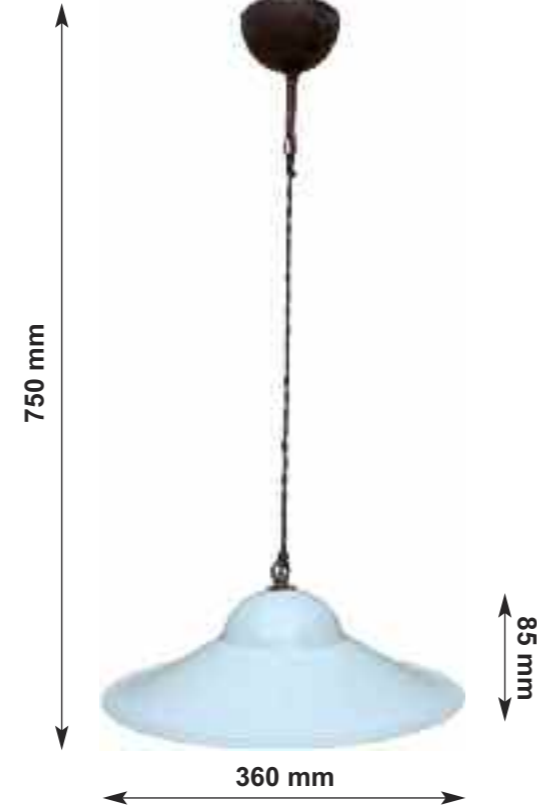

IP 20   
max 60 W E 27  
230 V 50 Hz

**Art. 5070 A**

Lampadario con contrappeso sali scendi in ceramica, con piatto piccolo bianco liscio.

CEILING PENDANT LIGHT WITH SMALL SIZE SMOOTH WHITE CERAMIC PLATE AND COUNTERWEIGHT.

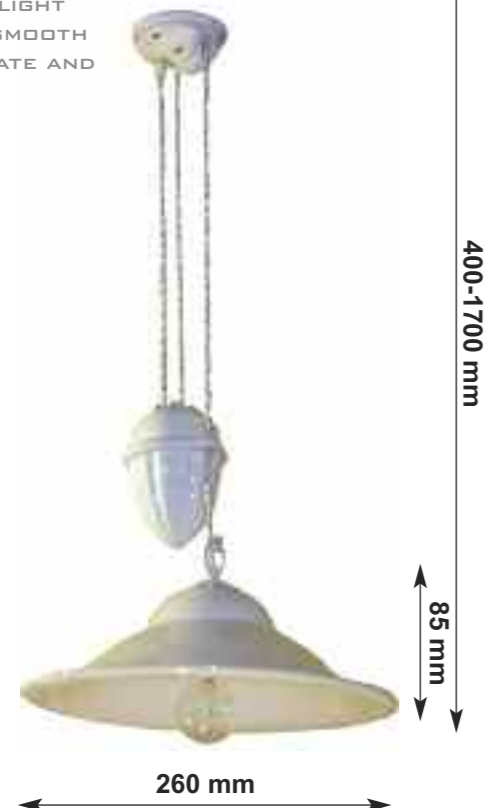

**Art. 5070**

Lampadario con piatto piccolo  
CEILING PENDANT LIGHT  
SMALL SIZE SMOOTH WHITE PLATE

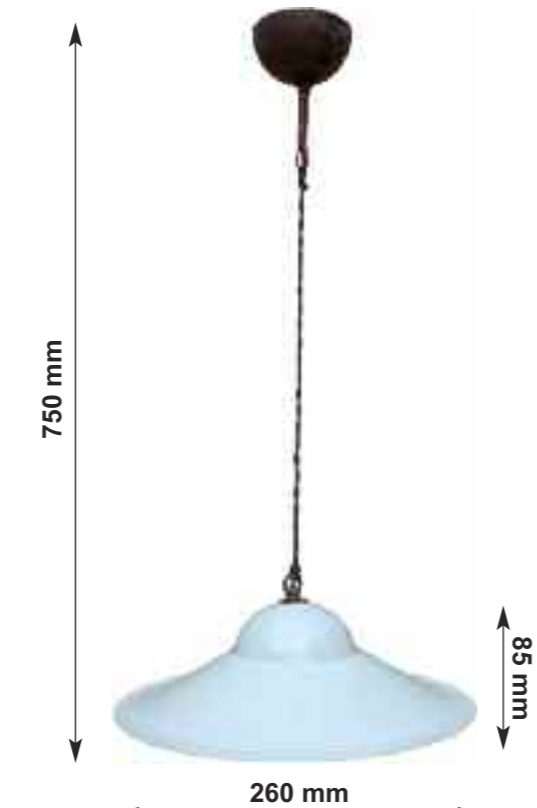

IP 20   
max 40 W E 14  
230 V 50 Hz



Lampade con paralumi in *ceramica avorio liscia*

Art. 5046

Applique  
piatto stretto

WALL LIGHT  
BELL-SHAPED SHADE



Art. 5047

Applique  
piatto largo

WALL LIGHT  
SMOOTH PLATE



IP 20   
max 40 W E 14  
230 V 50 Hz

Art. 5075

Applique  
piatto stretto

WALL LIGHT  
BELL-SHAPED SHADE



Art. 5077

Applique  
piatto largo

WALL LIGHT  
SMOOTH PLATE



IP 20   
max 40 W E 14  
230 V 50 Hz

Art. 5036

Applique  
piatto stretto

WALL LIGHT  
BELL-SHAPED SHADE



Art. 5037

Applique  
piatto largo

WALL LIGHT  
SMOOTH PLATE



IP 20   
max 40 W E 14  
230 V 50 Hz

Art. 5882

Applique  
WALL LAMP

stile arte povera con foglie di ferro forgiate a mano, avvolte allo stelo della lampada.  
Campana in ceramica avorio liscio.

COUNTRY LIFE STYLE LAMP, WITH IRON HAND FORGED TWISTED LEAVES.  
IVORY SMOOTH CERAMIC BELL-SHAPED SHADE.



IP 20   
max 40 W E 14  
230 V 50 Hz



# Lampade con paralumi in ceramica avorio liscia

## Art. 5080 A

Lampadario con contrappeso sali scendi in ceramica, con piatto grande avorio.

CEILING PENDANT LIGHT WITH BIG SIZE SMOOTH IVORY CERAMIC PLATE AND COUNTERWEIGHT.



## Art. 5080

Lampadario con piatto grande

CEILING PENDANT LIGHT BIG SIZE SMOOTH IVORY PLATE



IP 20 max 60 W € 27 230 V 50 Hz

## Art. 5081 A

Lampadario con contrappeso sali scendi in ceramica, con piatto piccolo avorio.

CEILING PENDANT LIGHT WITH SMALL SIZE SMOOTH IVORY CERAMIC PLATE AND COUNTERWEIGHT.



## Art. 5081

Lampadario con piatto piccolo

CEILING PENDANT LIGHT SMALL SIZE SMOOTH IVORY PLATE



IP 20 max 40 W € 14 230 V 50 Hz





Lampade con paralumi in *ceramica bianca smerlata*

**Art. 5030**

Appliche  
piatto stretto

WALL LIGHT WAVY  
BELL-SHAPED SHADE



**Art. 5031**

Appliche  
piatto largo

WALL LIGHT  
WAVY PLATE



IP 20 CE

max 40 W E 14  
230 V 50 Hz

**Art. 5040**

Appliche  
piatto stretto

WALL LIGHT WAVY  
BELL-SHAPED SHADE



**Art. 5039**

Appliche  
piatto largo

WALL LIGHT  
WAVY PLATE

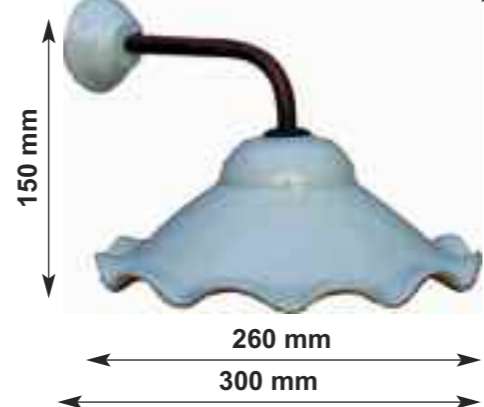

IP 20 CE

max 40 W E 14  
230 V 50 Hz

**Art. 5061**

Appliche  
piatto stretto

WALL LIGHT WAVY  
BELL-SHAPED SHADE



**Art. 5059**

Appliche  
piatto largo

WALL LIGHT  
WAVY PLATE

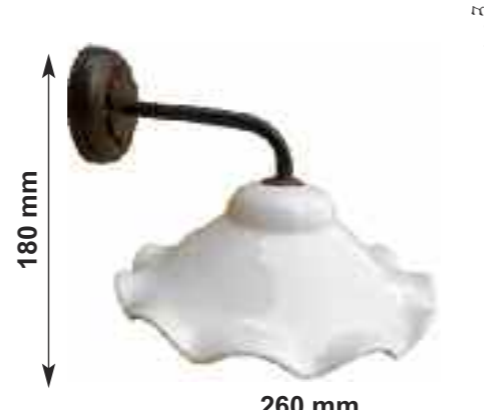

IP 20 CE

max 40 W E 14  
230 V 50 Hz

**Art. 5881**

Appliche

WALL LAMP

stile arte povera con foglie di ferro forgiate a mano, avvolte allo stelo della lampada. Campana in ceramica bianco smerlato.

COUNTRY LIFE STYLE LAMP, WITH IRON HAND FORGED TWISTED LEAVES. WITH THE WAVY CERAMIC BELL-SHAPED SHADE.

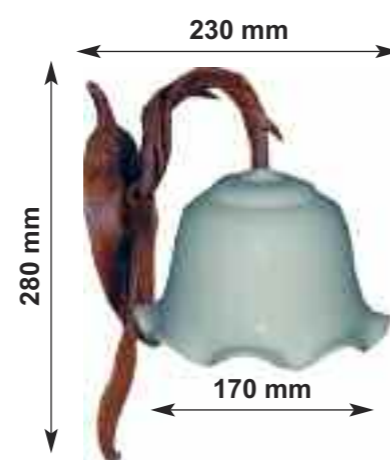

IP 20 CE

max 40 W E 14  
230 V 50 Hz



# Lampade con paralumi in ceramica bianca smerlata

## Art. 5051 A

Lampadario con contrappeso sali scendi in ceramica, con piatto grande bianco smerlato.

CEILING PENDANT LIGHT WITH BIG SIZE WAVY WHITE CERAMIC PLATE AND COUNTERWEIGHT.

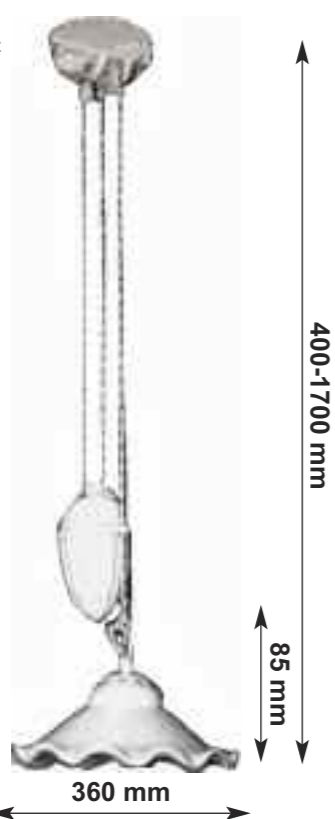

## Art. 5051

Lampadario con piatto grande

CEILING PENDANT LIGHT BIG SIZE WAVY WHITE PLATE

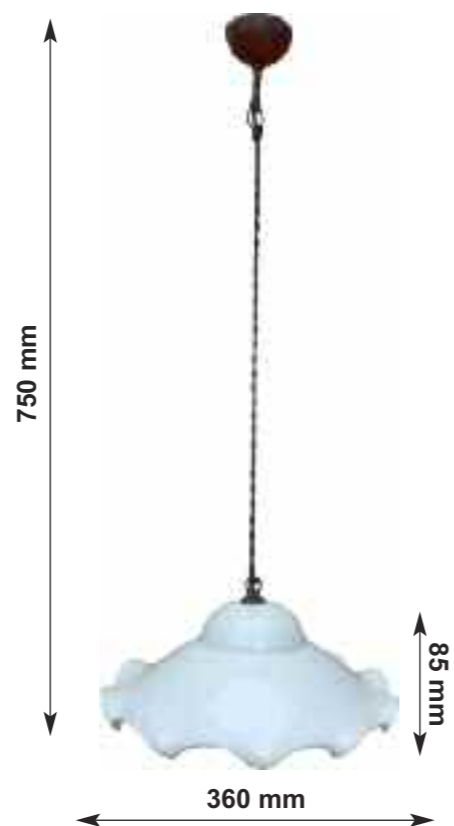

IP 20

max 60 W E 27  
230 V 50 Hz

## Art. 5050 A

Lampadario con contrappeso sali scendi in ceramica, con piatto piccolo bianco smerlato.

CEILING PENDANT LIGHT WITH SMALL SIZE WAVY WHITE CERAMIC PLATE AND COUNTERWEIGHT.

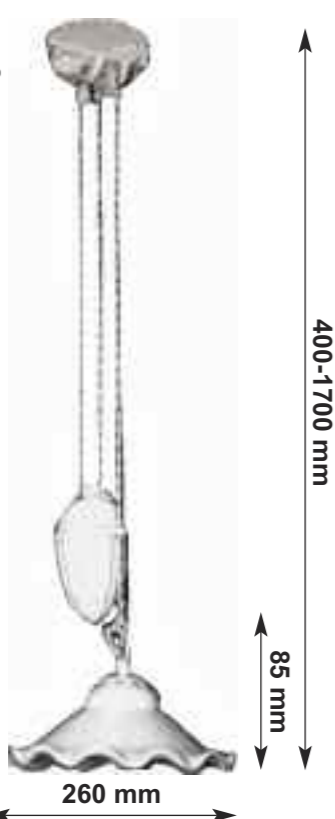

## Art. 5050

Lampadario con piatto piccolo

CEILING PENDANT LIGHT SMALL SIZE WAVY WHITE PLATE

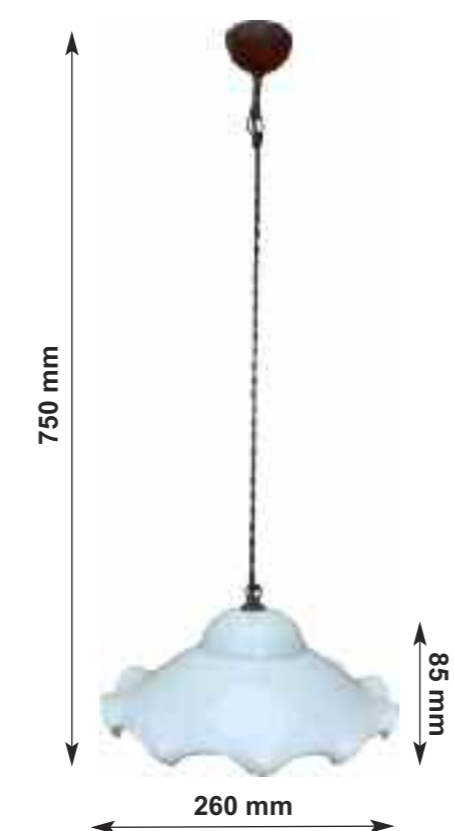

IP 20

max 40 W E 14  
230 V 50 Hz



Lampade con paralumi in *ceramica avorio smerlata*

Art. 5032

Appliche  
piatto stretto

WALL LIGHT WAVY  
BELL-SHAPED SHADE



Art. 5033

Appliche  
piatto largo

WALL LIGHT WAVY  
PLATE



IP 20

max 40 W E14  
230 V 50 Hz

Art. 5041

Appliche  
piatto stretto

WALL LIGHT WAVY  
BELL-SHAPED SHADE



Art. 5042

Appliche  
piatto largo

WALL LIGHT WAVY  
PLATE



IP 20

max 40 W E14  
230 V 50 Hz

Art. 5060

Appliche  
piatto stretto

WALL LIGHT WAVY  
BELL-SHAPED SHADE



Art. 5062

Appliche  
piatto largo

WALL LIGHT WAVY  
PLATE



IP 20

max 40 W E14  
230 V 50 Hz

Art. 5883

Appliche

WALL LAMP

stile arte povera con foglie di ferro forgiate a  
mano, avvolte allo stelo della lampada.  
Campana in ceramica bianco liscio.

COUNTRY LIFE STYLE LAMP, WITH IRON HAND  
FORGED TWISTED LEAVES.  
IVORY WAVY CERAMIC BELL-SHAPED SHADE.

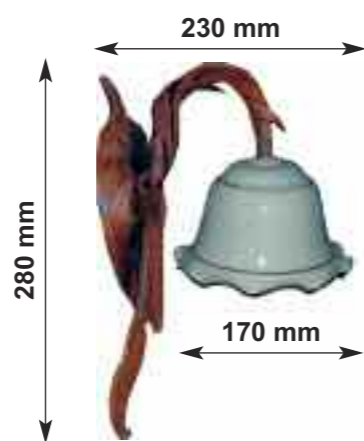

IP 20

max 40 W E14  
230 V 50 Hz



Since 1943 Love for Tradition



Lampade con paralumi in *ceramica avorio smerlata*

**Art. 5090 A**

Lampadario con contrappeso sali scendi in ceramica, con piatto grande avorio smerlato.

CEILING PENDANT LIGHT WITH BIG SIZE WAVY IVORY CERAMIC PLATE AND COUNTERWEIGHT.

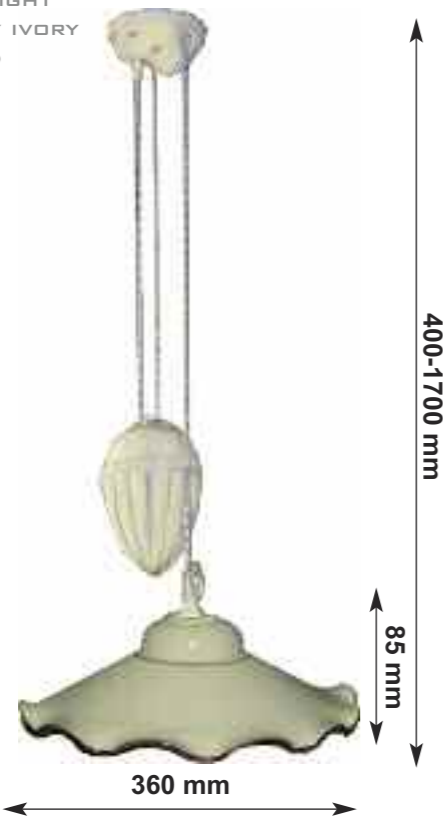

**Art. 5090**

Lampadario con piatto grande

CEILING PENDANT LIGHT  
BIG SIZE WAVY IVORY PLATE



IP 20

max 60 W E 27  
230 V 50 Hz

**Art. 5091 A**

Lampadario con contrappeso sali scendi in ceramica, con piatto piccolo avorio smerlato.

CEILING PENDANT LIGHT WITH SMALL SIZE WAVY IVORY CERAMIC PLATE AND COUNTERWEIGHT.

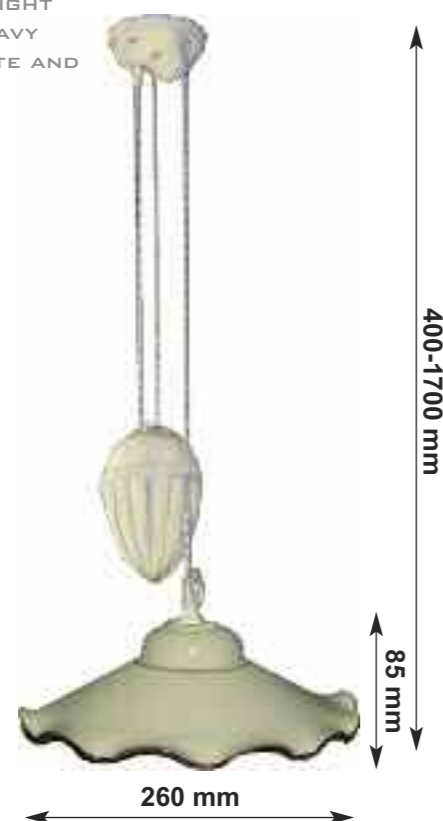

**Art. 5091**

Lampadario con piatto piccolo

CEILING PENDANT LIGHT  
SMALL SIZE WAVY IVORY PLATE



IP 20

max 40 W E 14  
230 V 50 Hz



# Lampade in vetro di Murano

MURANO GLASS LAMPSHADE

Vetro Scavo Liscio

SMOOTH SANDBLASTED GLASS



Vetro Scavo Smerlato

WAVY SANDBLASTED GLASS



Vetro Trasparente Oro

GOLDEN CLEAR GLASS



# Art. 6200

IP 20 CE  
max 40 W E 14  
230 V 50 Hz

Applique  
WALL LIGHT

Lampada in stile rustico, con vetro scavo di murano liscio.

COUNTRY LIFE STYLE PLAIN LAMP.  
MEDIUM SIZE. SMOOTH SANDBLASTED GLASS



Leggere differenze di forma e di colore non sono da considerarsi difetti ma caratteristiche  
Small differences in shape and colour characterize the originality of our hand made products

# Art. 6220

IP 20 CE  
max 40 W E 14  
230 V 50 Hz

Applique  
WALL LIGHT

Lampada in stile rustico.  
Piccole dimensioni.

COUNTRY LIFE STYLE PLAIN LAMP.  
SMALL SIZE.



A- con vetro scavo di murano liscio  
SMOOTH SANDBLASTED GLASS



B- con vetro scavo di murano smerlato



WAVY SANDBLASTED GLASS

Leggere differenze di forma e di colore non sono da considerarsi difetti ma caratteristiche  
Small differences in shape and colour characterize the originality of our hand made products



# Art. 6210

Applique  
WALL LIGHT

Lampada in stile rustico.

COUNTRY LIFE STYLE LAMP.

IP 20   
 max 40 W E 14   
 230 V 50 Hz



Leggere differenze di forma e di colore non sono da considerarsi difetti ma caratteristiche  
Small differences in shape and colour characterize the originality of our hand made products

# Art. 6205

Applique  
WALL LIGHT

Lampada in stile rustico.

COUNTRY LIFE STYLE LAMP.

IP 20   
 max 40 W E 14   
 230 V 50 Hz



A- con vetro scavo di murano liscio  
SMOOTH SANDBLASTED GLASS



B- con vetro scavo di murano smerlato  
WAVY SANDBLASTED GLASS



Leggere differenze di forma e di colore non sono da considerarsi difetti ma caratteristiche  
Small differences in shape and colour characterize the originality of our hand made products

# Art. 6215

Applique  
WALL LIGHT

Lampada in stile rustico, ad una luce.  
Piccole dimensioni.

SINGLE LIGHT COUNTRY LIFE STYLE LAMP.  
SMALL SIZE.

IP 20   
 max 40 W E 14   
 230 V 50 Hz



A- con vetro scavo di murano liscio  
SMOOTH SANDBLASTED GLASS



B- con vetro scavo di murano smerlato  
WAVY SANDBLASTED GLASS



Leggere differenze di forma e di colore non sono da considerarsi difetti ma caratteristiche  
Small differences in shape and colour characterize the originality of our hand made products

# Art. 6216

Applique  
WALL LIGHT

Lampada in stile rustico, a due luci.  
Piccole dimensioni.

TWIN LIGHT COUNTRY LIFE STYLE LAMP.  
SMALL SIZE.

IP 20   
 max 40 W x 2 E 14   
 230 V 50 Hz



A- con vetro scavo di murano liscio  
SMOOTH SANDBLASTED GLASS



B- con vetro scavo di murano smerlato  
WAVY SANDBLASTED GLASS



Leggere differenze di forma e di colore non sono da considerarsi difetti ma caratteristiche  
Small differences in shape and colour characterize the originality of our hand made products

### Art. 6240

Plafoniera diametro mm 350  
GLASS DIAMETER

### Art. 6241

Plafoniera diametro mm 450  
GLASS DIAMETER

### Art. 6242

Plafoniera diametro mm 550  
GLASS DIAMETER

IP 20   
max 60 W x 3 E 27  
230 V 50 Hz



Plafoniera in stile rustico con vetro scavo di murano  
SANDBLASTED GLASS COUNTRY LIFE STYLE  
CEILING LIGHT

Leggere differenze di forma e di colore non sono da considerarsi difetti ma caratteristiche  
Small differences in shape and colour characterize the originality of our hand made products

### Art. 6230

Applique misura piccola  
WALL LIGHT SMALL SIZE GLASS

larghezza WIDTH mm 370  
sporgenza DEPTH mm 200  
altezza HEIGHT mm 130

### Art. 6231

Applique misura media  
WALL LIGHT MEDIUM SIZE GLASS

larghezza WIDTH mm 460  
sporgenza DEPTH mm 220  
altezza HEIGHT mm 140

IP 20   
max 60 W x 3 E 27  
230 V 50 Hz

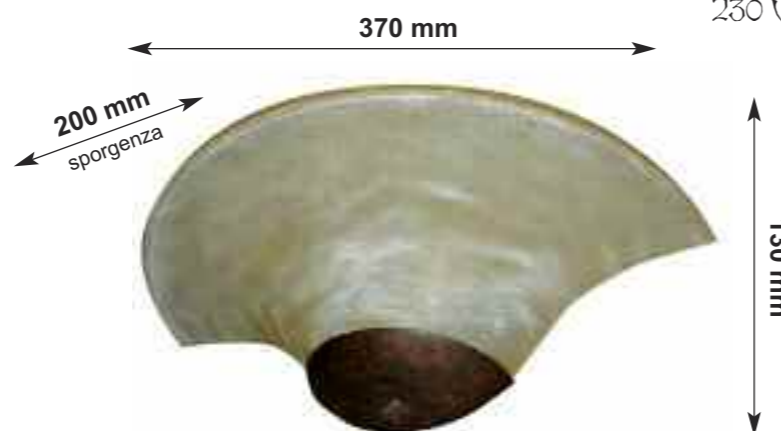

Lampada in stile rustico con vetro scavo di murano  
SANDBLASTED GLASS COUNTRY LIFE STYLE WALL LIGHT

Leggere differenze di forma e di colore non sono da considerarsi difetti ma caratteristiche  
Small differences in shape and colour characterize the originality of our hand made products



[www.armoniedepoca.com](http://www.armoniedepoca.com)





### Art. 6245

Plafoniera diametro mm 350  
GLASS DIAMETER

### Art. 6246

Plafoniera diametro mm 450  
GLASS DIAMETER

### Art. 6247

Plafoniera diametro mm 550  
GLASS DIAMETER

Plafoniera in stile rustico con vetro scavo di murano

SANDBLASTED GLASS COUNTRY LIFE STYLE  
CEILING LIGHT



IP 20   
max 60 W x 3 € 27  
230 V 50 Hz

Leggere differenze di forma e di colore non sono da considerarsi difetti ma caratteristiche  
Small differences in shape and colour characterize the originality of our hand made products

### Art. 6260

Appliche misura piccola  
WALL LIGHT SMALL SIZE GLASS

larghezza WIDTH mm 370  
sporgenza DEPTH mm 200  
altezza HEIGHT mm 300

### Art. 6261

Appliche misura media  
WALL LIGHT MEDIUM SIZE GLASS

larghezza WIDTH mm 460  
sporgenza DEPTH mm 220  
altezza HEIGHT mm 320



IP 20   
max 60 W € 27  
230 V 50 Hz

Lampada in stile medievale con vetro scavo di murano, supporto in ferro forgiato a mano.

MEDIEVAL STYLE LAMP WITH MURANO  
SANDBLASTED GLASS SHADE.  
HAND FORGED BRACKET.  
MEDIUM SIZE.

Leggere differenze di forma e di colore non sono da considerarsi difetti ma caratteristiche  
Small differences in shape and colour characterize the originality of our hand made products



# Art. 6400

Applique

WALL LIGHT

Lampada in stile liberty con vetro scavo di murano, supporto in ferro forgiato a mano.  
Misura piccola.

ART DECÒ STYLE LAMP WITH MURANO SANDBLASTED GLASS SHADE.  
HAND FORGED BRACKET.  
SMALL SIZE.



IP 20 CE  
max 60 W E27  
230 V 50 Hz

Leggere differenze di forma e di colore non sono da considerarsi difetti ma caratteristiche  
Small differences in shape and colour characterize the originality of our hand made products

# Art. 6405

Applique

WALL LIGHT

Lampada in stile liberty con vetro scavo di murano, supporto in ferro forgiato a mano.  
Misura media.

ART DECÒ STYLE LAMP WITH MURANO SANDBLASTED GLASS SHADE.  
HAND FORGED BRACKET.  
MEDIUM SIZE.



IP 20 CE  
max 60 W E27  
230 V 50 Hz

Leggere differenze di forma e di colore non sono da considerarsi difetti ma caratteristiche  
Small differences in shape and colour characterize the originality of our hand made products

# Art. 6410

Applique

WALL LIGHT

Lampada in stile liberty con vetro scavo di murano, supporto in ferro forgiato a mano.

ART DECÒ STYLE LAMP WITH MURANO SANDBLASTED GLASS SHADE.  
HAND FORGED BRACKET.

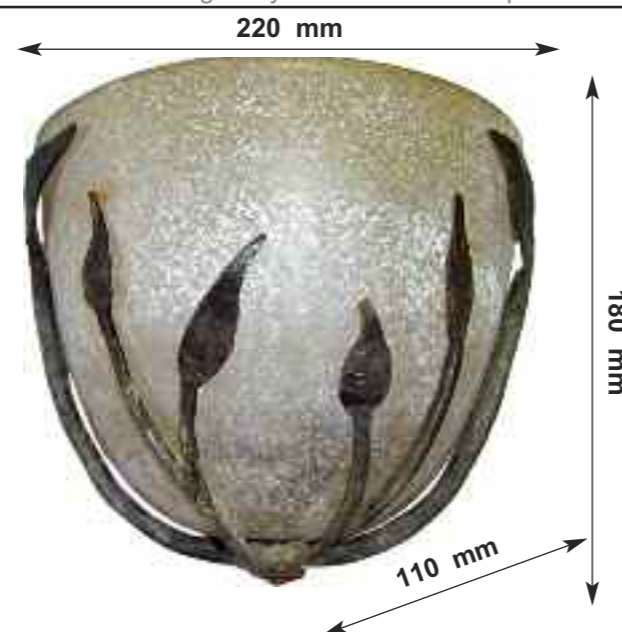

IP 20 CE  
max 60 W E27  
230 V 50 Hz

Leggere differenze di forma e di colore non sono da considerarsi difetti ma caratteristiche  
Small differences in shape and colour characterize the originality of our hand made products



# Art. 6225

Abat-jour

TABLE LAMP

Lampada in stile rustico.

COUNTRY LIFE STYLE LAMP.

IP 20   
 max 60 W E 27   
 230 V 50 Hz

A con vetro scavo di murano liscio   
 SMOOTH SANDBLASTED GLASS



B con vetro scavo di murano smerlato   
 WAVY SANDBLASTED GLASS



Leggere differenze di forma e di colore non sono da considerarsi difetti ma caratteristiche   
 Small differences in shape and colour characterize the originality of our hand made products



Since 1943 Love for Tradition



### Art. 6270

Lampadario a Soffitto

CEILING PENDANT LIGHT

Lampada in stile rustico con vetro soavo di murano, supporto in ferro forgiato a mano.

HAND FORGED COUNTRY LIFE STYLE LAMP WITH MURANO SANDBLASTED GLASS SHADE.



IP 20 CE  
max 60 W E 27  
230 V 50 Hz

Leggere differenze di forma e di colore non sono da considerarsi difetti ma caratteristiche  
Small differences in shape and colour characterize the originality of our hand made products

### Art. 6280

Lampadario a Soffitto

CEILING PENDANT LIGHT

Lampada in stile rustico con vetro soavo di murano.

COUNTRY LIFE STYLE PLAIN LAMP WITH MURANO SANDBLASTED GLASS SHADE.



IP 20 CE  
max 60 W E 27  
230 V 50 Hz

Leggere differenze di forma e di colore non sono da considerarsi difetti ma caratteristiche  
Small differences in shape and colour characterize the originality of our hand made products

### Art. 6285

Applique

WALL LIGHT

Lampada in stile rustico con vetro soavo di murano.

COUNTRY LIFE STYLE PLAIN LAMP WITH MURANO SANDBLASTED GLASS SHADE.



IP 20 CE  
max 60 W E 27  
230 V 50 Hz

Leggere differenze di forma e di colore non sono da considerarsi difetti ma caratteristiche  
Small differences in shape and colour characterize the originality of our hand made products



# Art. 6290

lampadario a soffitto

CEILING PENDANT LIGHT

Lampada in stile rustico con vetro scavo di Murano.

COUNTRY LIFE STYLE PLAIN LAMP WITH MURANO SANDBLASTED GLASS SHADE.



IP 20 CE  
max 40 W E14  
230 V 50 Hz

Leggere differenze di forma e di colore non sono da considerarsi difetti ma caratteristiche  
Small differences in shape and colour characterize the originality of our hand made products

# Art. 6291

lampadario a soffitto

CEILING PENDANT LIGHT

Lampada in stile rustico con vetro scavo di Murano.

COUNTRY LIFE STYLE PLAIN LAMP WITH MURANO SANDBLASTED GLASS SHADE.

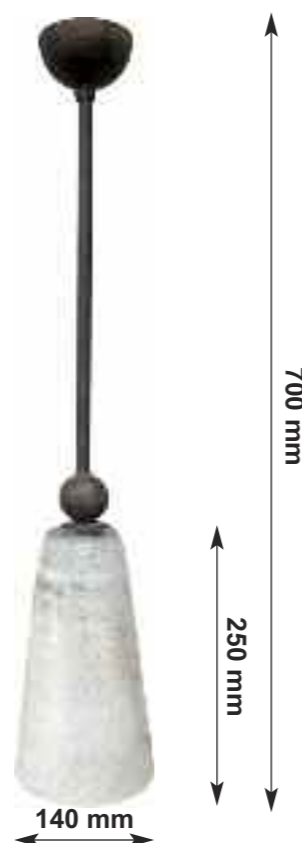

IP 20 CE  
max 40 W E14  
230 V 50 Hz

Leggere differenze di forma e di colore non sono da considerarsi difetti ma caratteristiche  
Small differences in shape and colour characterize the originality of our hand made products



# I Vetri di Murano Murano's Glass

I vetri da noi proposti sono realizzati completamente a Venezia nell'isola di Murano nelle fornaci di una delle Aziende con radici storiche nel campo della lavorazione del vetro. I modelli sono direttamente disegnati dallo studio di Armonie d'epoca e prodotti esclusivamente per noi. Forti di ciò siamo quindi in grado di poter soddisfare qualsiasi esigenza diversa da quella proposta come forma, dimensione e tonalità di colore del vetro.

# I Vetri di Murano Murano's Glass

The glass we offer is made in Murano Island, near Venice, by one of the historic companies of glass working. Armonie d'Epoca designs the models and the glass company creates them for us. In this way we can meet our customer demands offering alternative glass, shapes, size and colours.

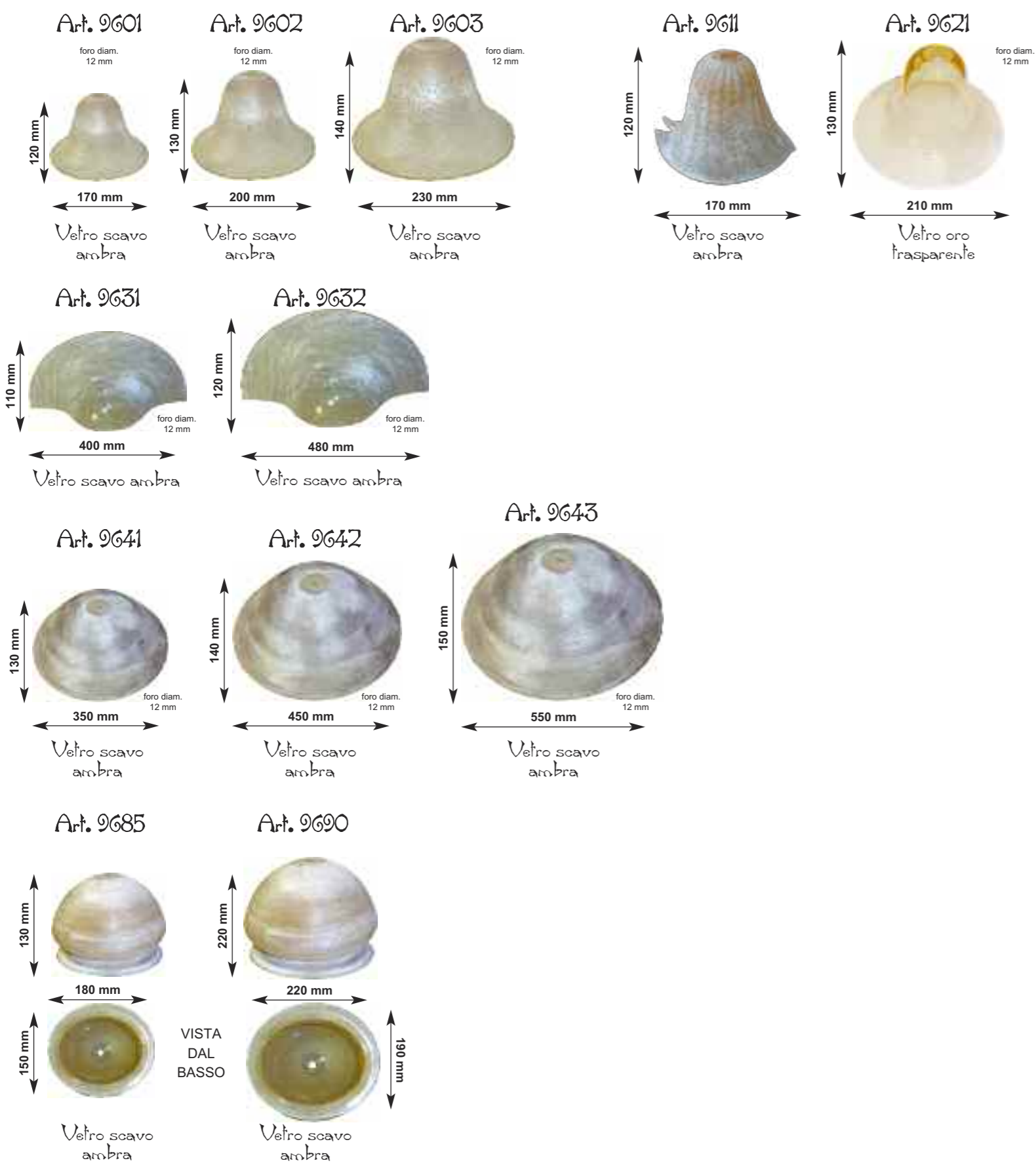

# Candelieri

CANDLE HOLDERS

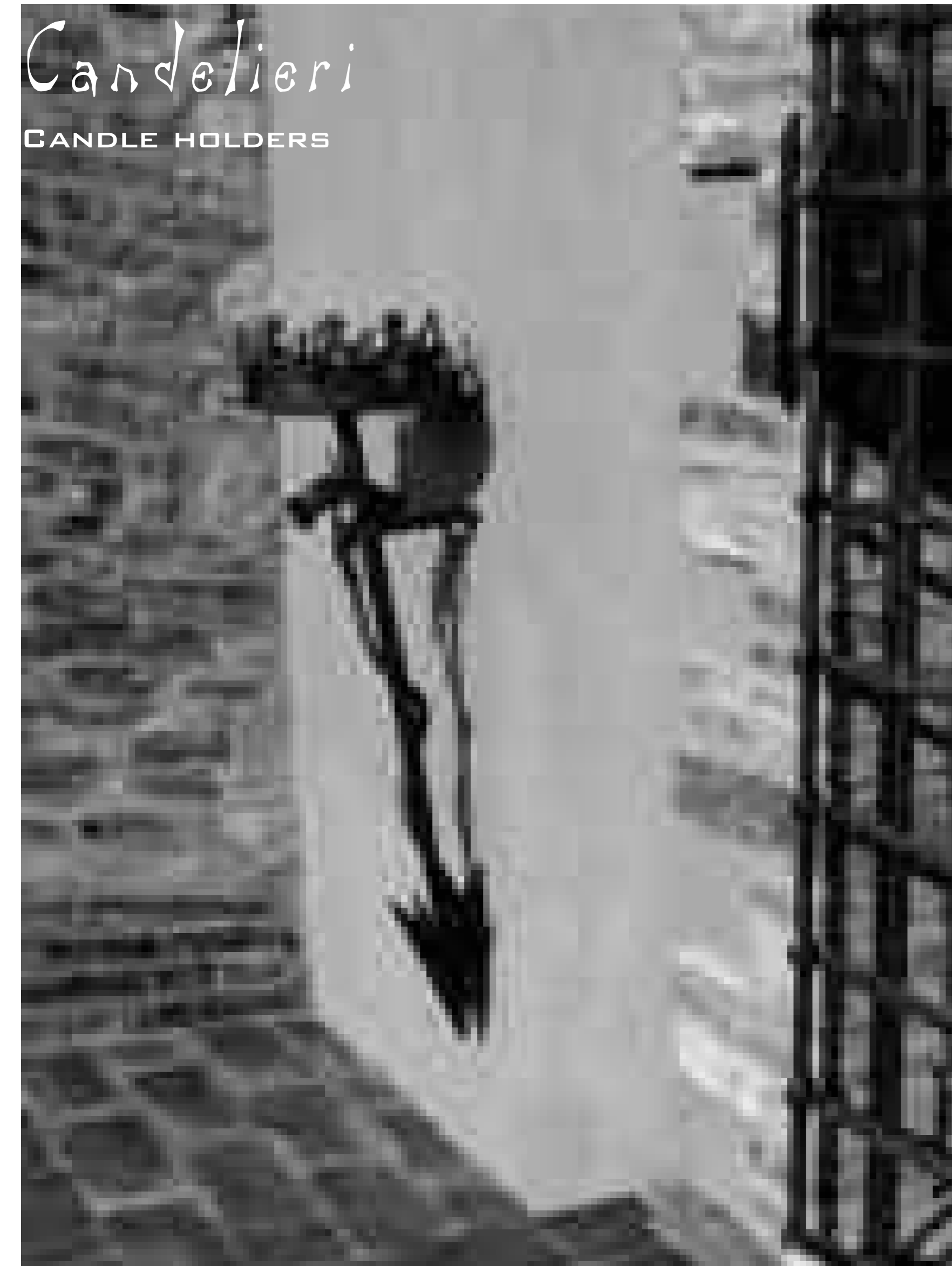

Candelieri  
in ferro battuto

WAVY SANDBLASTED GLASS



Lanterne

in ferro battuto  
e vetro



# Art. 6300

Candelieri

CANDLE HOLDER

Porta ceri da parete, porta bandiera da esterno in ferro battuto.

WROUGHT IRON WALL CANDLE HOLDER. IT CAN BE USED AS A STANDARD BEARER.



# Art. 6310

Candelieri

SCONCE

Candelieri a parete in ferro battuto.

WROUGHT IRON SCONCE.

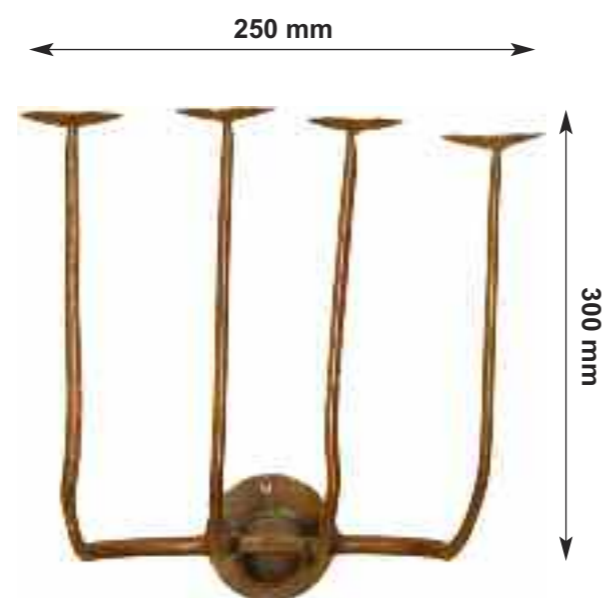

# Art. 6320

Candelieri

SCONCE

Candelieri a parete in ferro battuto.

WROUGHT IRON SCONCE.

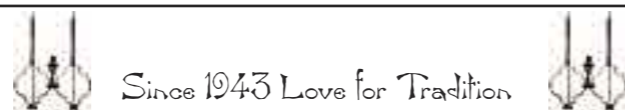

Since 1943 Love for Tradition

www.armoniedepoca.com



### Art. 6330

Porta fiaccola

TORCH

Porta fiaccole da parete in ferro battuto.

WROUGHT IRON TORCH.



### Art. 6340

Porta fiaccola

TORCH

Porta fiaccola in stile medievale da parete in ferro battuto per ingressi importanti, con drago forgiato a mano e braciere a corona.

WROUGHT IRON MEDIEVAL STYLE TORCH FOR HALL DOORS, WITH HAND FORGED DRAGON AND CROWN



### Art. 6350

Lanterna

LANTERN

Lanterna in stile rustico.

COUNTRY LIFE STYLE LANTERN.

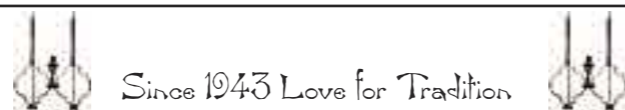
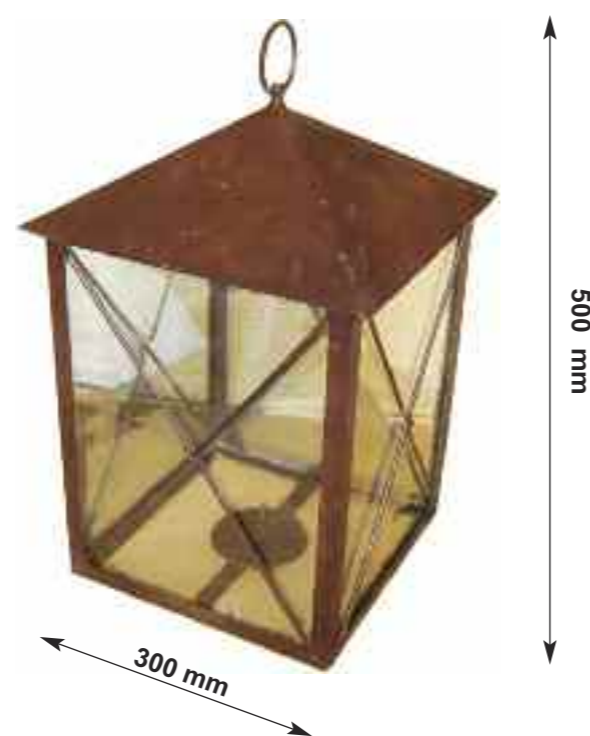

Since 1943 Love for Tradition

www.armoniedepoca.com

### Art. 6355

Lanterna

LANTERN

Lanterna in stile rustico.  
Misura grande.

COUNTRY LIFE STYLE LANTERN.  
BIG SIZE.

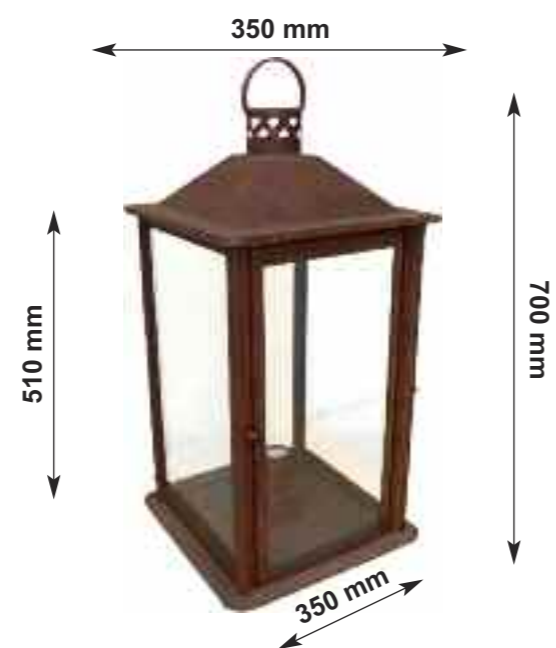

### Art. 6356

Lanterna

LANTERN

Lanterna in stile rustico.  
Misura media.

COUNTRY LIFE STYLE LANTERN.  
MEDIUM SIZE.



### Art. 6357

Lanterna

LANTERN

Lanterna in stile rustico.  
Misura piccola.

COUNTRY LIFE STYLE LANTERN.  
SMALL SIZE.

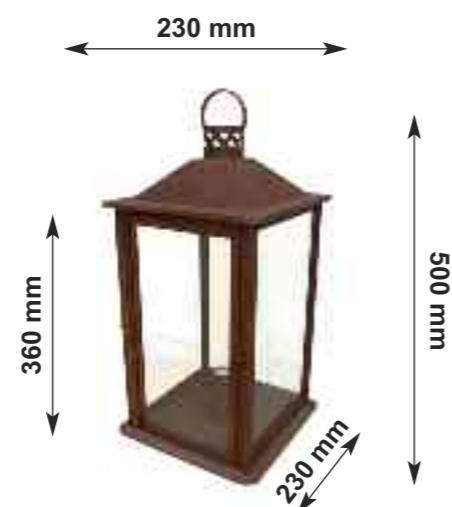

### Art. 6360

Lanterna

LANTERN

Lanterna in stile rustico.  
Misura grande.

COUNTRY LIFE STYLE LANTERN.  
BIG SIZE.



### Art. 6361

Lanterna

LANTERN

Lanterna in stile rustico.  
Misura media.

COUNTRY LIFE STYLE LANTERN.  
MEDIUM SIZE.

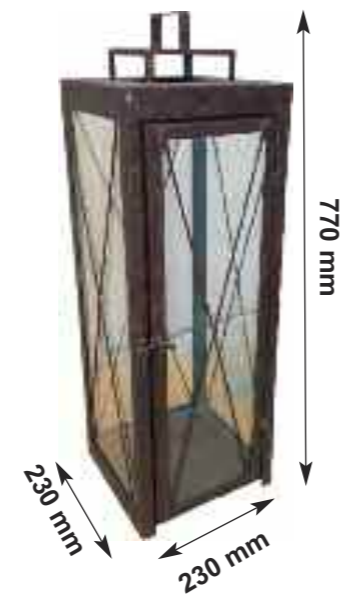

### Art. 6362

Lanterna

LANTERN

Lanterna in stile rustico.  
Misura piccola.

COUNTRY LIFE STYLE LANTERN.  
SMALL SIZE.

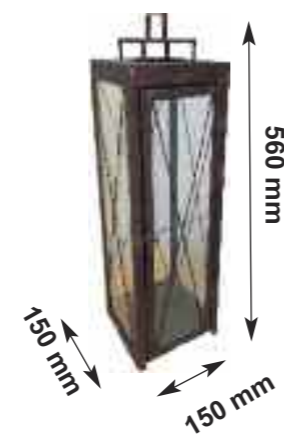

### Art. 6390

Candeliere da parete

SCONCE

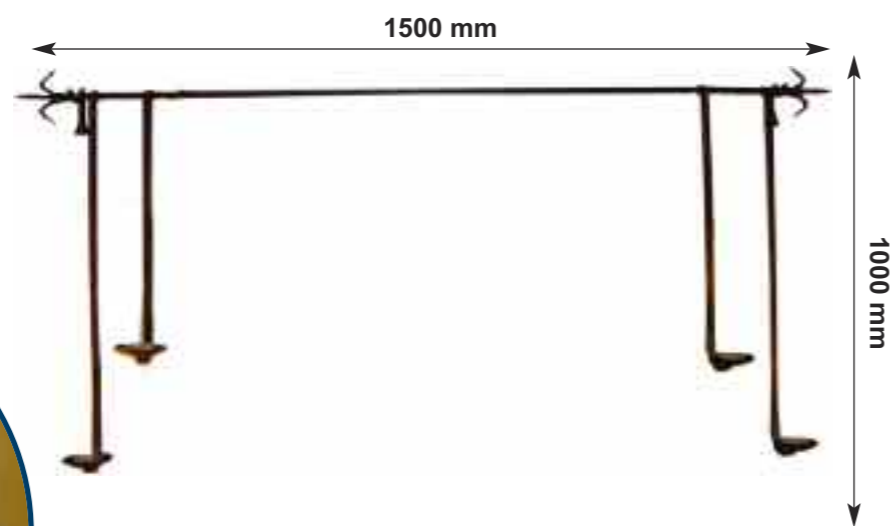
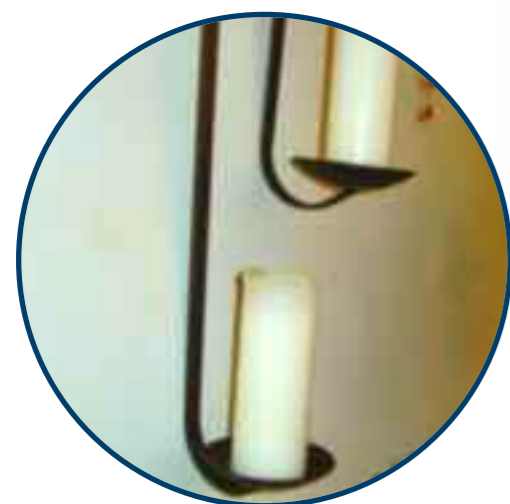

### Art. 6370

Candeliere da camino

FIRE PLACE CANDLE HOLDER

Porta candele in ferro battuto.

WROUGHT IRON CANDLE HOLDER.

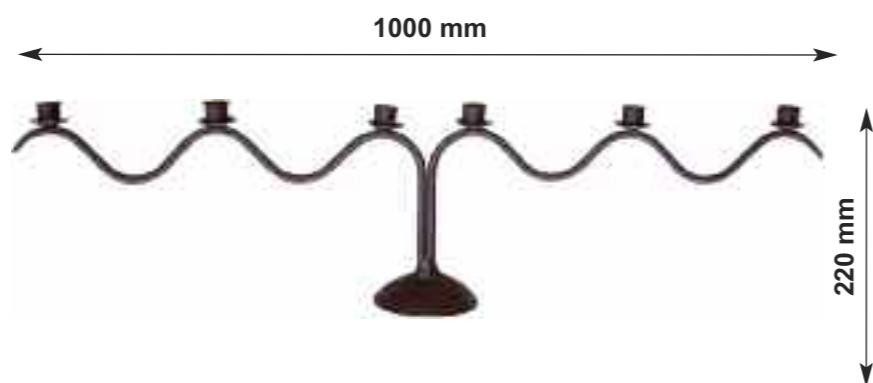

### Art. 6380

Candeliere

FIRE PLACE CANDLE HOLDER

Porta candele in ferro battuto in stile orientale.

WROUGHT IRON ORIENTAL STYLE CANDLE HOLDER.



Since 1943 Love for Tradition

www.armoniedepoca.com

### Art. 6385

Candeliere

FIRE PLACE CANDLE HOLDER

Porta candele in ferro battuto in stile orientale.

WROUGHT IRON ORIENTAL STYLE CANDLE HOLDER.



### Art. 6386

Candeliere

FIRE PLACE CANDLE HOLDER

Porta candele in ferro battuto in stile orientale.

WROUGHT IRON ORIENTAL STYLE CANDLE HOLDER.



### Art. 6387

Candeliere

FIRE PLACE CANDLE HOLDER

Porta candele in ferro battuto in stile orientale.

WROUGHT IRON ORIENTAL STYLE CANDLE HOLDER.



V

a

r

i

e

cavi e componenti

Cavo Tessuto

a 2 o 3 fili colore  
marrone



Cavo Tessuto

a 2 o 3 fili colore  
bianco



Passacavo

in porcellana per  
impianti a vista



### Art. 6990

Cavo

FABRIC CABLE

Cavo tessuto a due fili colore marrone

TWO CORE BROWN TWISTED FABRIC CABLE.



### Art. 6991

Cavo

FABRIC CABLE

Cavo tessuto a tre fili colore marrone

THREE CORE BROWN TWISTED FABRIC CABLE.



### Art. 6992

Cavo

FABRIC CABLE

Cavo tessuto a due fili colore avorio

TWO CORE IVORY TWISTED FABRIC CABLE.



### Art. 6993

Cavo

FABRIC CABLE

Cavo tessuto a tre fili colore avorio.

THREE CORE IVORY TWISTED FABRIC CABLE.



### Art. 6996

Passacavo in Ceramica

CERAMIC WIRE TIDY

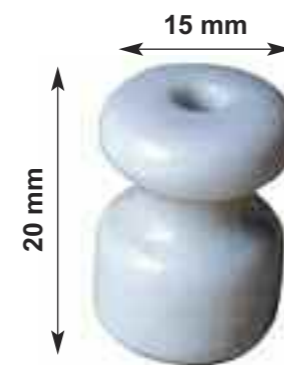

Since 1943 Love for Tradition





*listino prezzi*

—  
—  
—  
—  
—  
—  
—  
—



# INDICE

articolo	foto	pagina	prezzo
1062		157	€ 268,00
1063		159	€ 268,00
1064		157	€ 138,00
1065		159	€ 138,00
1066		159	€ 123,00
1067		157	€ 123,00
1068		157	€ 166,00
2040		161	A:€ 267,00 B:€ 267,00
2041		163	A:€ 267,00 B:€ 267,00
2045		161	A:€ 138,00 B:€ 138,00
2046		163	A:€ 138,00 B:€ 138,00
2050		161	A:€ 123,00 B:€ 123,00
2051		163	A:€ 123,00 B:€ 123,00
2052		161	€ 166,00
3034		165	A:€ 395,00 B:€ 395,00
3035		167	A:€ 395,00 B:€ 395,00
3036		167	€ 135,00
3037		165	€ 135,00
3038		165	€ 138,00
3039		167	€ 138,00

articolo	foto	pagina	prezzo
3040		165	€ 181,00
5030		181	€ 130,00
5031		181	€ 157,00
5032		185	€ 134,00
5033		185	€ 164,00
5034		173	€ 112,00
5035		173	€ 141,00
5036		177	€ 121,00
5037		177	€ 149,00
5039		181	€ 154,00
5040		181	€ 126,00
5041		185	€ 133,00
5042		183	€ 162,00
5044		173	€ 147,00
5045		173	€ 119,00
5046		177	€ 127,00
5047		177	€ 155,00
5050		183	€ 155,00
5050A		183	€ 263,00
5051		183	€ 243,00

articolo	foto	pagina	prezzo
5051A		183	€ 330,00
5059		181	€ 151,00
5060		185	€ 130,00
5061		181	€ 122,00
5062		185	€ 158,00
5070		175	€ 154,00
5070A		175	€ 252,00
5071		175	€ 224,00
5071A		175	€ 302,00
5074		173	€ 146,00
5075		177	€ 125,00
5076		173	€ 117,00
5077		177	€ 154,00
5080		179	€ 240,00
5080A		179	€ 320,00
5081		179	€ 159,00
5081A		179	€ 268,00
5090		187	€ 269,00
5090A		187	€ 347,00
5091		187	€ 165,00
5091A		187	€ 281,00

articolo	foto	pagina	prezzo
5100		147	€ 234,00
5120		145	€ 191,00
5130		145	€ 219,00
5131		147	€ 297,00
5140		145	€ 296,00
5141		147	€ 362,00
5150		149	€ 349,00
5151		149	€ 252,00
5155		149	€ 1.236,00
5160		31	€ 3.132,00
5161		32	€ 5.604,00
5162		33	€ 6.757,00
5163		34	€ 9.806,00
5169		31	€ 42,00
5180		43	€ 743,00
5180A		43	€ 1.045,00
5180B		43	€ 1.045,00
5180C		43	€ 1.045,00
5180D		43	€ 1.045,00
5180V		43	€ 1.251,00
5185		43	€ 1.545,00
5185A		43	€ 1.854,00
5185B		43	€ 1.854,00
5185C		43	€ 1.854,00
5185D		43	€ 1.854,00



# INDICE

articolo	foto	pagina	prezzo
5650		41	€ 286,00
5655		41	€ 396,00
5660		43	€ 388,00
5670		129	€ 437,00
5675		129	€ 541,00
5680		129	€ 645,00
5690		55	€ 152,00
5691		55	€ 186,00
5692		55	€ 170,00
5720		11	€ 259,00
5730		17	€ 505,00
5731		17	€ 552,00
5732		17	€ 396,00
5735		15	€ 645,00
5736		15	€ 718,00
5740		125	€ 149,00
5750		125	€ 184,00
5760		37	€ 295,00
5761		37	€ 315,00
5762		37	€ 315,00
5765		37	€ 354,00

articolo	foto	pagina	prezzo
5770		152	€ 151,00
5771		115	€ 220,00
5773		117	€ 156,00
5774		117	€ 210,00
5778		117	€ 468,00
5780		47	A:€ 182,00 B:€ 170,00
5785		49	€ 202,00
5790		51	€ 219,00
5791		51	€ 202,00
5795		51	€ 396,00
5800		71	A:€ 848,00 B:€ 874,00
5810		71	€ 624,00
5880		173	€ 162,00
5881		181	€ 171,00
5882		177	€ 171,00
5883		185	€ 180,00
5885		157	€ 191,00
5886		157	€ 191,00
5890		93	A:€ 349,00 B:€ 375,00
5891		91	A:€ 503,00 B:€ 544,00
5892		93	A:€ 622,00 B:€ 664,00
5893		91	A:€ 503,00 B:€ 544,00

articolo	foto	pagina	prezzo
5894		93	A:€ 572,00 B:€ 614,00
5895		95	A:€ 541,00 B:€ 572,00
5896		95	A:€ 853,00 B:€ 916,00
5897		95	A:€ 1.154,00 B:€ 1.257,00
5900		65	€ 879,00
5901		65	€ 994,00
5902		63	€ 791,00
5903		67	€ 933,00
5904		67	€ 645,00
5905		63	€ 832,00
5911		119	€ 208,00
5912		119	€ 240,00
5913		119	€ 271,00
5914		120	€ 333,00
5950		69	A:€ 1.648,00 B:€ 1.854,00
5960		70	A:€ 936,00 B:€ 1.020,00
6000		137	€ 227,00
6005		137	€ 234,00
6011		139	€ 258,00
6012		139	€ 289,00
6013		139	€ 308,00
6014		139	€ 339,00

articolo	foto	pagina	prezzo
6015		139	€ 412,00
6025		141	€ 306,00
6030		141	€ 260,00
6050		143	€ 160,00
6051		143	€ 190,00
6101		133	€ 96,00
6102		133	€ 154,00
6106		134	€ 96,00
6107		134	€ 117,00
6111		135	€ 117,00
6112		135	€ 202,00
6116		136	€ 96,00
6117		136	€ 149,00
6180		81	€ 147,00
6182		81	€ 199,00
6183		82	€ 224,00
6184		82	€ 255,00
6185		83	€ 152,00
6186		83	€ 202,00
6187		83	€ 229,00
6188		85	€ 245,00

# INDICE

articolo	foto	pagina	prezzo
6190		85	€ 229,00
6192		87	€ 312,00
6193		89	€ 281,00
6194		88	€ 458,00
6195		89	€ 416,00
6198		90	€ 208,00
6199		90	€ 191,00
6200		191	€ 191,00
6205		193	A:€ 202,00 B:€ 202,00
6210		193	€ 359,00
6215		194	A:€ 138,00 B:€ 138,00
6216		194	A:€ 229,00 B:€ 229,00
6220		191	A:€ 138,00 B:€ 138,00
6225		201	A:€ 191,00 B:€ 191,00
6230		195	€ 271,00
6231		195	€ 312,00
6240		195	€ 364,00
6241		195	€ 468,00
6242		195	€ 572,00
6245		197	€ 395,00
6246		197	€ 500,00

articolo	foto	pagina	prezzo
6247		197	€ 603,00
6260		197	€ 375,00
6261		197	€ 416,00
6270		203	€ 728,00
6280		203	€ 468,00
6285		203	€ 499,00
6290		205	€ 375,00
6291		205	€ 333,00
6300		211	€ 159,00
6310		211	€ 85,00
6320		211	€ 250,00
6330		213	€ 106,00
6340		213	€ 1.040,00
6350		213	€ 208,00
6355		215	€ 229,00
6356		215	€ 202,00
6357		215	€ 170,00
6360		217	€ 333,00
6361		217	€ 281,00
6362		217	€ 217,00
6370		219	€ 138,00

articolo	foto	pagina	prezzo
6380		219	€ 208,00
6385		221	€ 191,00
6386		221	€ 208,00
6387		221	€ 229,00
6390		219	€ 396,00
6400		199	€ 416,00
6405		199	€ 448,00
6410		199	€ 437,00
6420		169	€ 260,00
6421		169	€ 260,00
6990		225	€ 2,00 mt
6991		225	€ 3,00 mt
6992		225	€ 2,00 mt
6993		225	€ 3,00 mt
6996		225	€ 5,00
7021		3	€ 1.442,00
7022		3	€ 1.854,00
7023		3	€ 2.266,00
7031		9	€ 1442,00
7032		9	€ 1854,00
7033		9	€ 2266,00

# FINITURE COLORI FINISHES OPTIONS

Trattamenti anticati a cera AGEING FINISHES FINAL TOP COAT WAX TREATMENT

## FINITURA STANDARD STANDARD FINISH

Ferro Vecchio DARK RUST IRON



cod. FV

## FINITURE EXTRA NERE EXTRA BLACK FINISHES

10% in più sul prezzo di listino

10% ADDED ON THE PRICE LIST

Nero Opaco MATT BLACK



cod. NO

Grigio Ferro NATURAL IRON



cod. GF

Grafite BLACK LEAD



cod. G

Nero Vecchio AGED BLACK

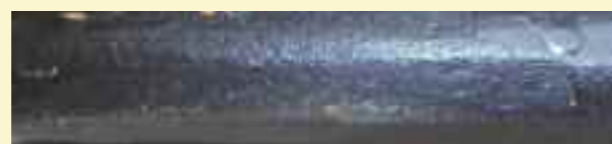

cod. NV

## FINITURE DECOUPAGE DECOUPAGE FINISHES

realizzate con foglia oro e argento 22 carati  
30% in più sul prezzo di listino

MADE WITH 22 CARAT GOLD OR SILVER LEAF.  
30% ADDED ON THE PRICE LIST

Foglia Oro GOLD LEAF



cod. FO

Foglia Argento SILVER LEAF



cod. FA

## FINITURE EXTRA COLORE EXTRA COLOUR FINISHES

20% in più sul prezzo di listino

20% ADDED ON THE PRICE LIST

Verde Anticato VERDIGRIS



cod. VA

Blue Anticato AGED BLUE



cod. BA

Bronzo Anticato AGED BRONZE



cod. BRA

Oro Impero EMPIRE GOLD



cod. OI

Argento Impero EMPIRE SILVER



cod. AI

Cotto Antico OLD TILE



cod. CA

Grigio Azzurro Anticato AGED GREY-LIGHT BLUE



cod. GAA

Oro Anticato AGED GOLD



cod. OA

Rame Anticato AGED COPPER



cod. RA

Avorio Anticato AGED IVORY



cod. AA

Bianco Vecchio AGED WHITE



cod. BV

Verde Pompei GREEN POMPEI



cod. VP

Blue Pompei BLUE POMPEI



cod. BP



Since 1943 Love for Tradition

www.armoniedepoca.com





**Armonie d'Epoca  
di Ubaldi Massimo**

Via Cristoforo Colombo, 21/c

05100 Terni - Italia

Tel. + 39 0744 423928

e-mail: [armoniedepoca@gmail.com](mailto:armoniedepoca@gmail.com)

[www.armoniedepoca.com](http://www.armoniedepoca.com)



Distribuito da:

**METAL GROUP S.p.a.**

Viale Europa 1/3/5 Cerea (VR) Italia

Tel. + 39 0442 83777 Fax + 39 0442 370243

e-mail: [marketingms@metalstyle.it](mailto:marketingms@metalstyle.it)

[www.metalstyle.it](http://www.metalstyle.it)