

Assembly Instructions

Ashton Series

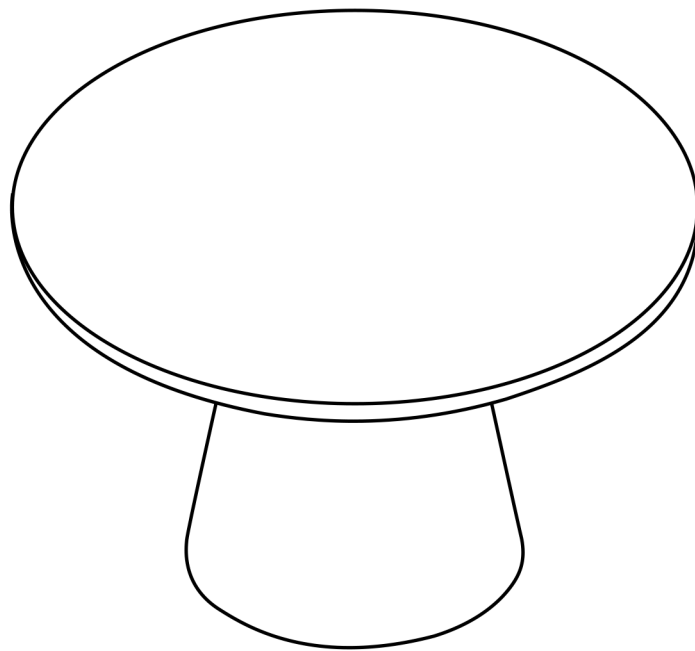

Lifely*

Product Name
ASTN-DT-LG Ashton Dining Table

Dimensions(Wx DxH)
1200x1200x750mm

Important

Please read through instruction carefully
Before assembly and keep for future reference.

For our full catalogue of assembly instructions,
Visit: lifely.com.au/assembly.

Important Tips and Maintenance



1. Keep children and animals away from working area as smaller parts may cause choking if swallowed.

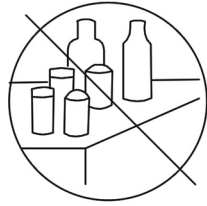

2. Never place liquids or anything damp upon furniture as it will mark. Ensure a coaster or running is beneath.



3. Never use ammonia based cleaning products as it will damage the finish.

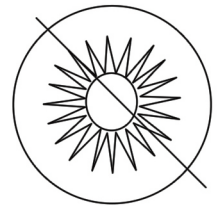

4. To avoid fading, keep furniture out of direct sunlight.

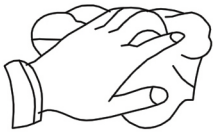

5. Use a soft or damp cloth (dry cloth) when wiping or cleaning surfaces.

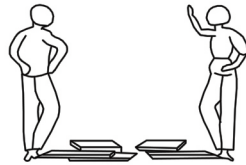

6. Two person are required.



7. Lay a soft matt down to protect the furniture piece before and during assembly.

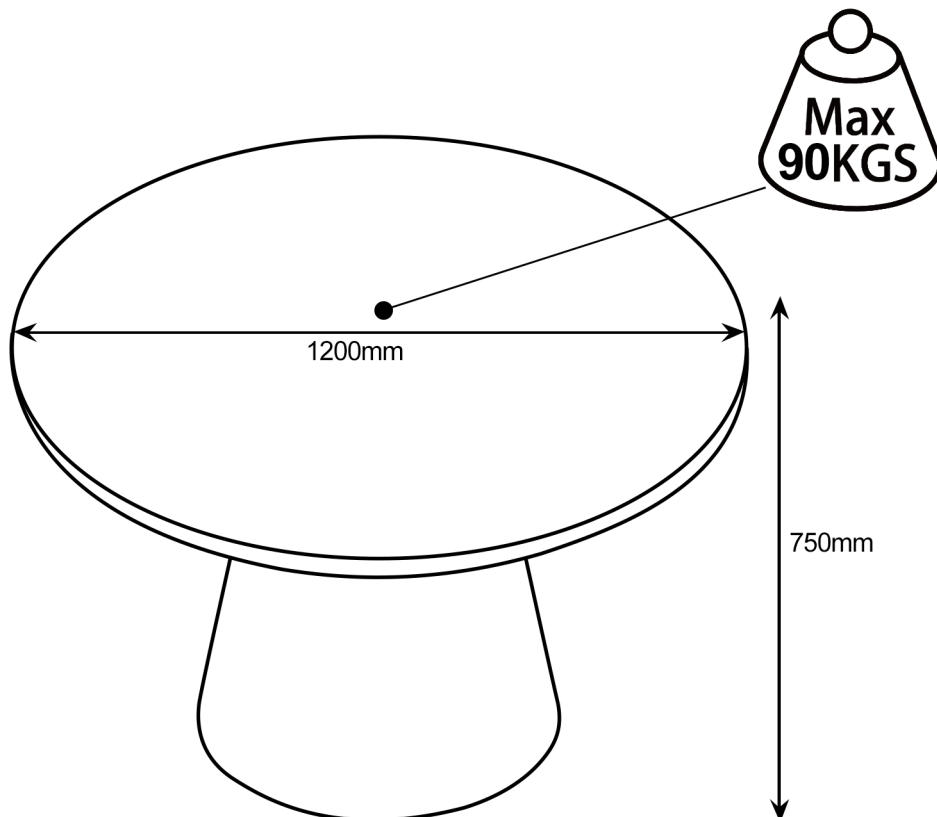

So your relationship is strong. But is it flat-pack furniture strong? Unless you're an aerospace engineer, assembling furniture can be slightly stressful. We recommend meditating quietly, pouring yourself a herbal tea (or slightly less herbal wine) and tackling things one step at a time. If you feel a passive aggressive remark coming on, try a compliment instead. E.g. "You're so good looking".

This 7-Step assembly should take around 20 minutes with an Allen Key-or 12 minutes with an electric drill. Godspeed.

Designed for everyday

Component Hardware are in box 1

Please check you have all the fittings
part or tools are listed in below.

No. A
Quantity: 1Pc
Allen Key M6



No. B
Quantity: 8Pcs
Felt Pad



No. C
Quantity: 4Pcs
Screw M8*25mm



No. D
Quantity: 4Pcs
Screw M8*30mm



Component Panels & part List

Please check you have all the panels
are listed below.

1. TABLE TOP ----- x1 2/2
2. MIDDLE FIXING PLATE ----- x1 2/2
3. TABLE FOOT SEAT ----- x1 1/2

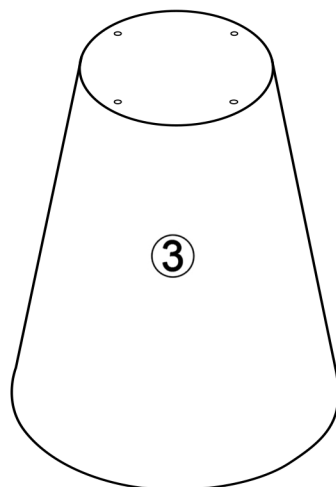
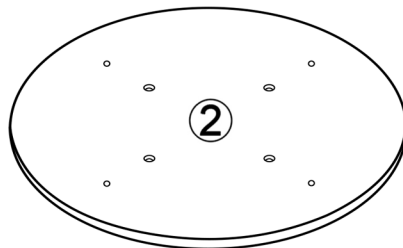
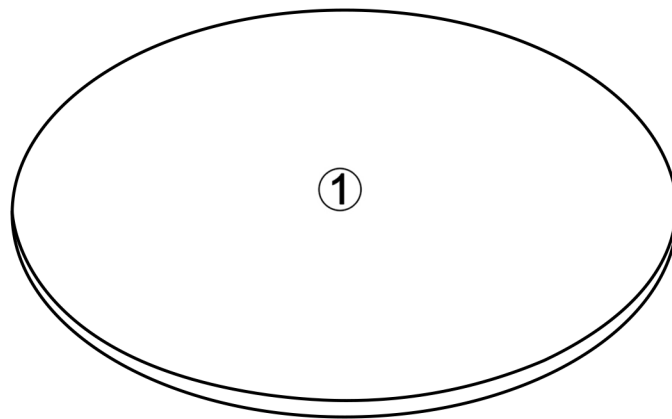

STEP 1

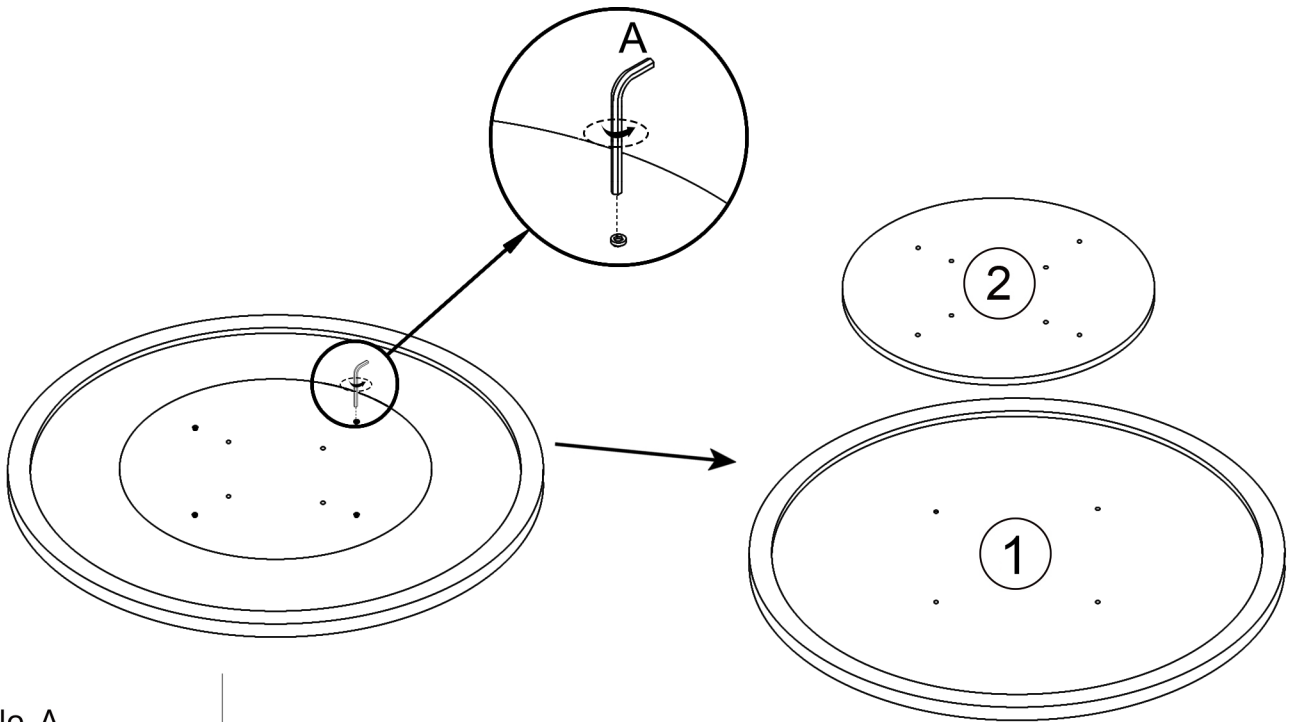

No. A
Quantity: 1Pc
Allen Key M6



STEP 2

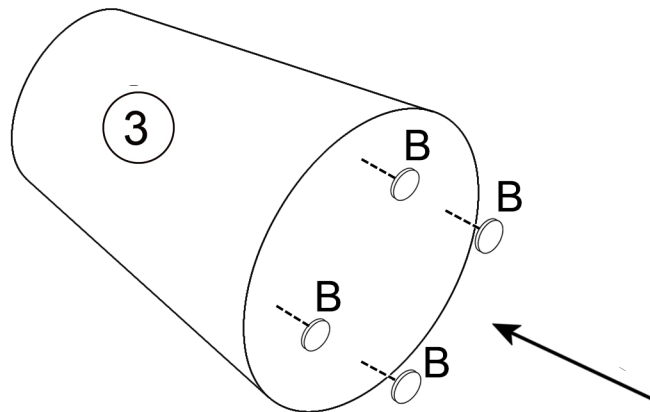

No. B
Quantity: 4Pcs
Felt Pad



If the bottom is uneven, please add one more pads to adjust

STEP 3

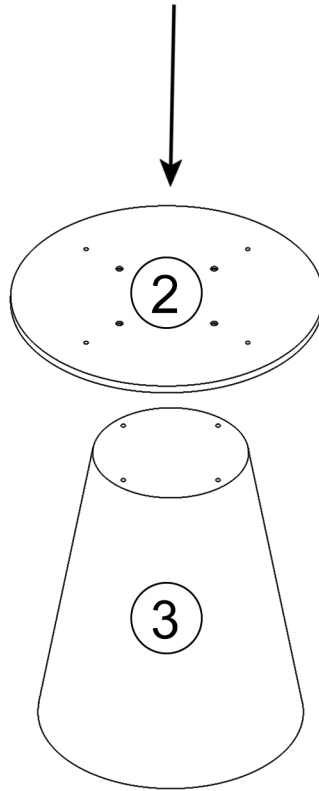

STEP 4

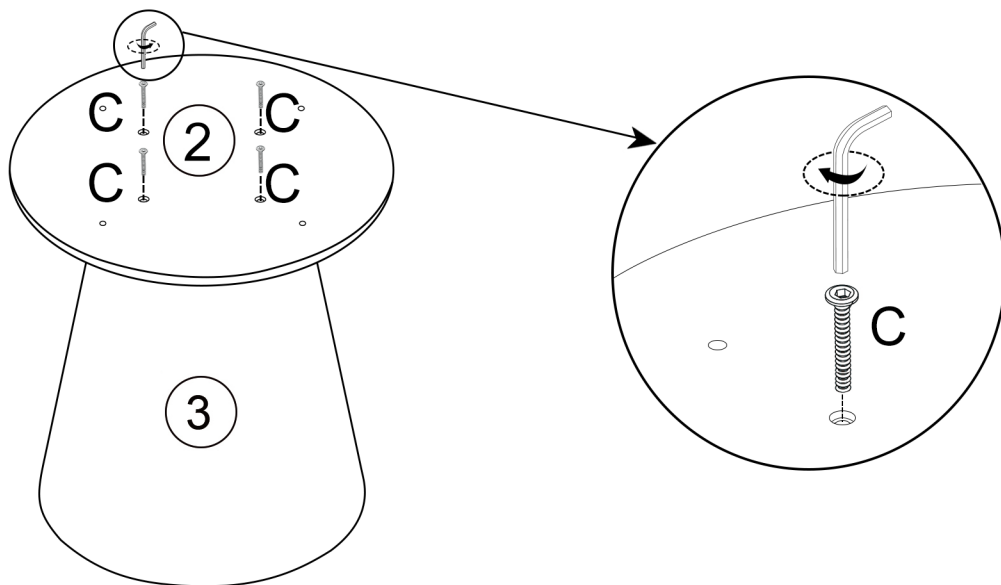

No. C
Quantity: 4Pcs
Screw M8*25mm



No. A
Quantity: 1Pc
Allen Key M6



STEP 5

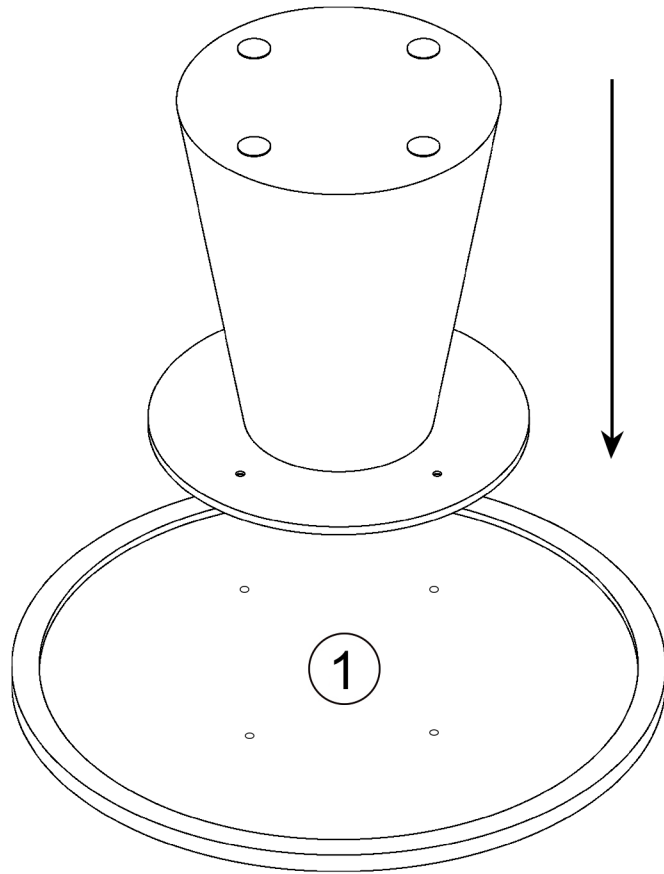

STEP 6

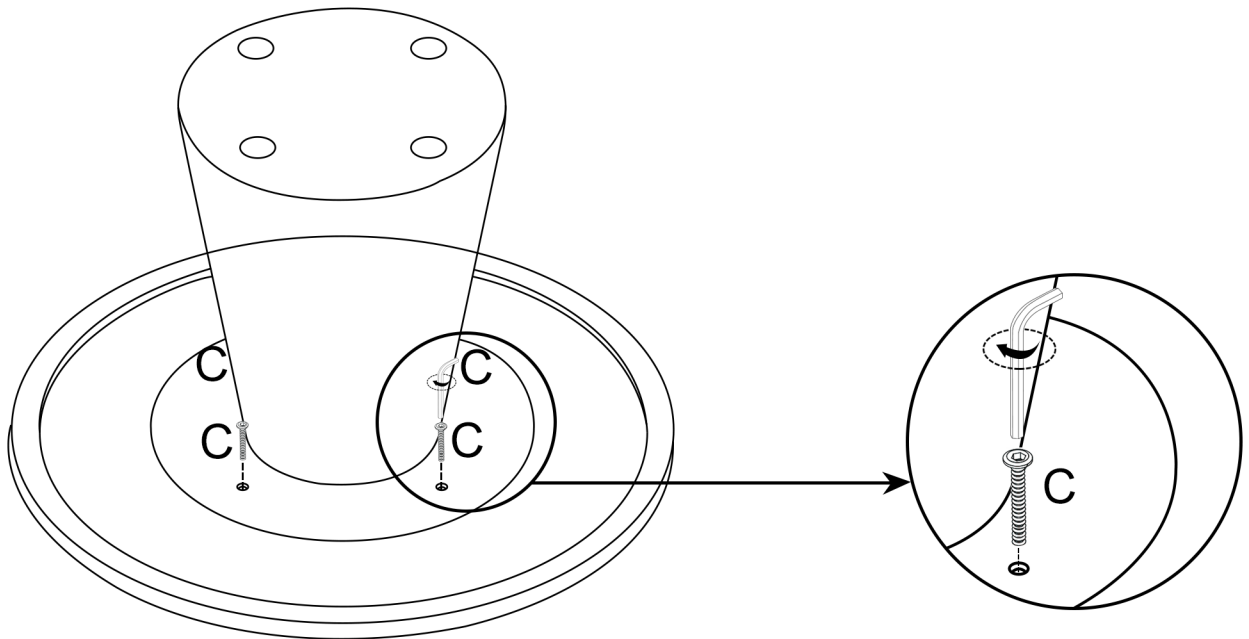

No. D
Quantity: 4Pcs
Screw M8*30mm



No. A
Quantity: 1Pc
Allen Key M6



STEP 7

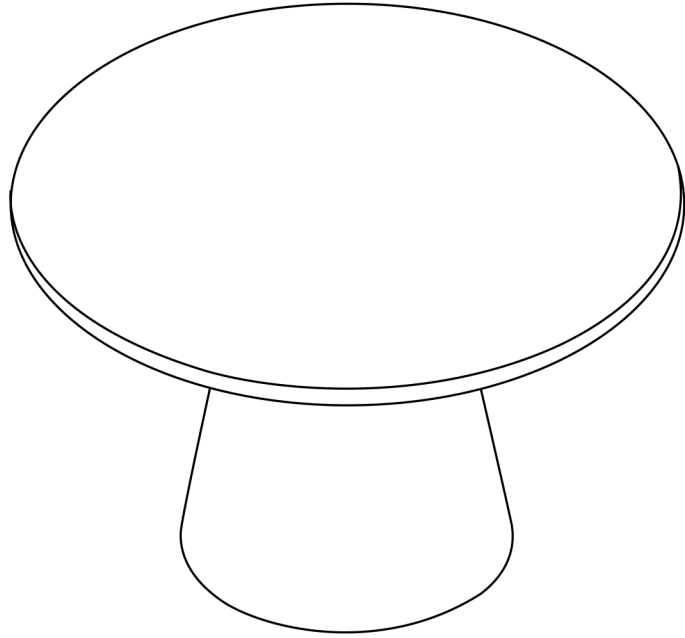

lifely.com.au

Great job. You're done!

Don't forget to share how it looks in
your space and tag us on Instagram.
[@lifelyhome](#) [#homewithlifely!](#)