

# Assembly Instructions

Gwen Series

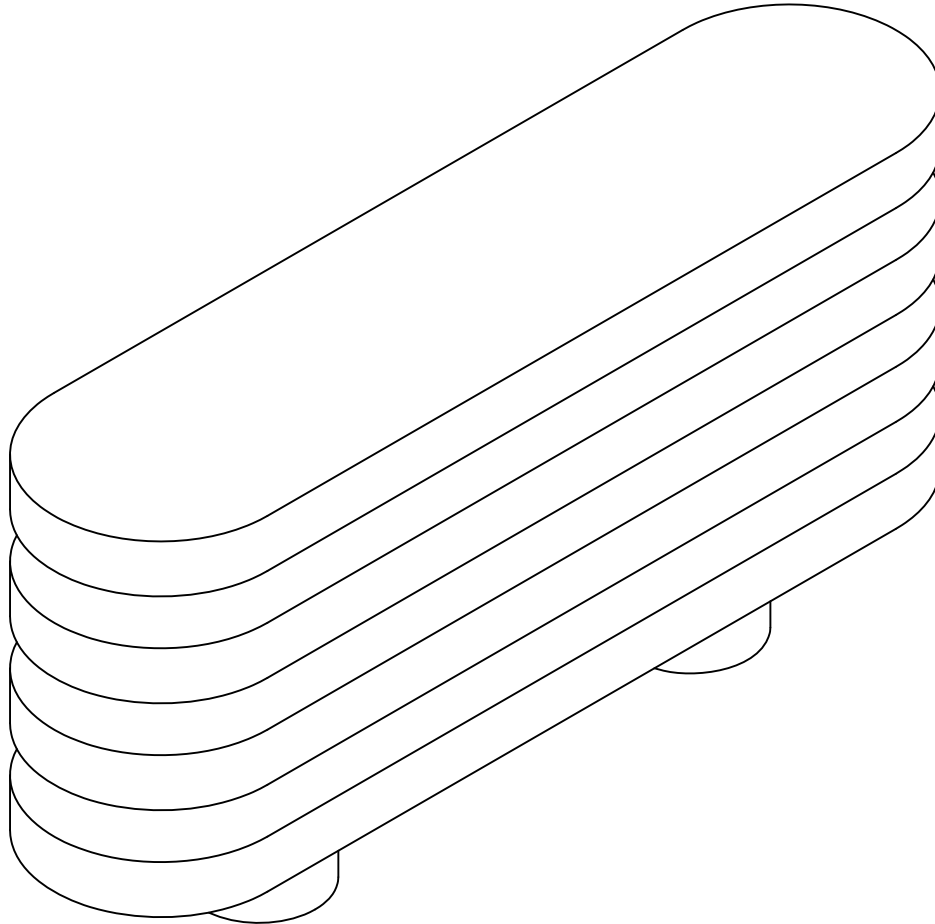

# Lifely\*

## Product Code

GWEN-CST-MBL Gwen Bedside Table

## Dimensions (W x D x H)

1500\*380\*740mm

---

## Important

Please read through instruction carefully  
Before assembly and keep for future reference.

For our full catalogue of assembly instructions,  
Visit: [lifely.com.au/assembly](http://lifely.com.au/assembly).

## Important Tips and Maintenance

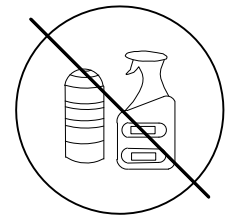
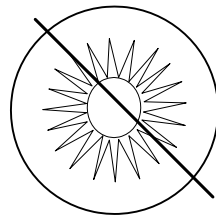
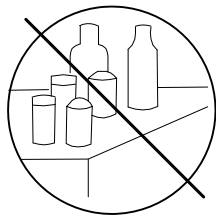

1. Keep children and animals away from working area as smaller parts may cause choking if swallowed.

2. Never place liquids or anything damp upon furniture as it will mark. Ensure a coaster or running is beneath.

3. Never use ammonia based cleaning products as it will damage the finish.

4. To avoid fading, keep furniture out of direct sunlight.

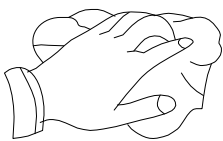

5. Use a soft or damp cloth (dry cloth) when wiping or cleaning surfaces.

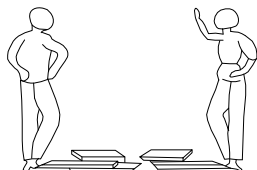

6. Two person are required.

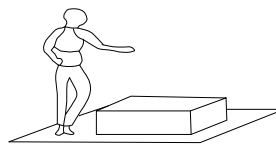

7. Lay a soft matt down to protect the furniture piece before and during assembly.

So your relationship is strong. But is it flat-pack furniture strong? Unless you're an aerospace engineer, assembling furniture can be slightly stressful. We recommend meditating quietly, pouring yourself a herbal tea (or slightly less herbal wine) and tackling things one step at a time. If you feel a passive aggressive remark coming on, try a compliment instead. E.g. "You're so good looking."

This 10-step assembly should take around 48 minutes with an Allen key- or 35 minutes with an electric drill.

Designed for everyday

## Component Hardware

Please check you have all the fittings  
part or tools are listed in below.

**No. A**  
Quantity:24 Pcs  
Screw  
M8\*100mm

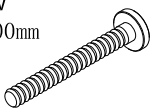

**No. B**  
Quantity:4 Pcs  
Screw  
M8\*175

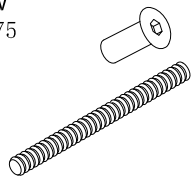

**No. C**



L=200mm

**No. D**  
Quantity:6 Pcs  
EVA Pad  
φ 25mm



**No. E**  
Quantity:1 Pc  
Key  
5mm



**No. F**  
Quantity:1 Pc  
Key  
5mm



**No. G**  
Quantity:1 Pair  
Gloves



# Component Panels & part List

Please check you have all the panels are listed below.

- 1. Top Panel-----x1 CTN 1/3
- 2. Shelf-----x2 CTN 2/3
- 3. Bottom Panel-----x1 CTN 1/3
- 4. Leg-----x2 CTN 3/3
- 5. Connecting -----x6 CTN 3/3

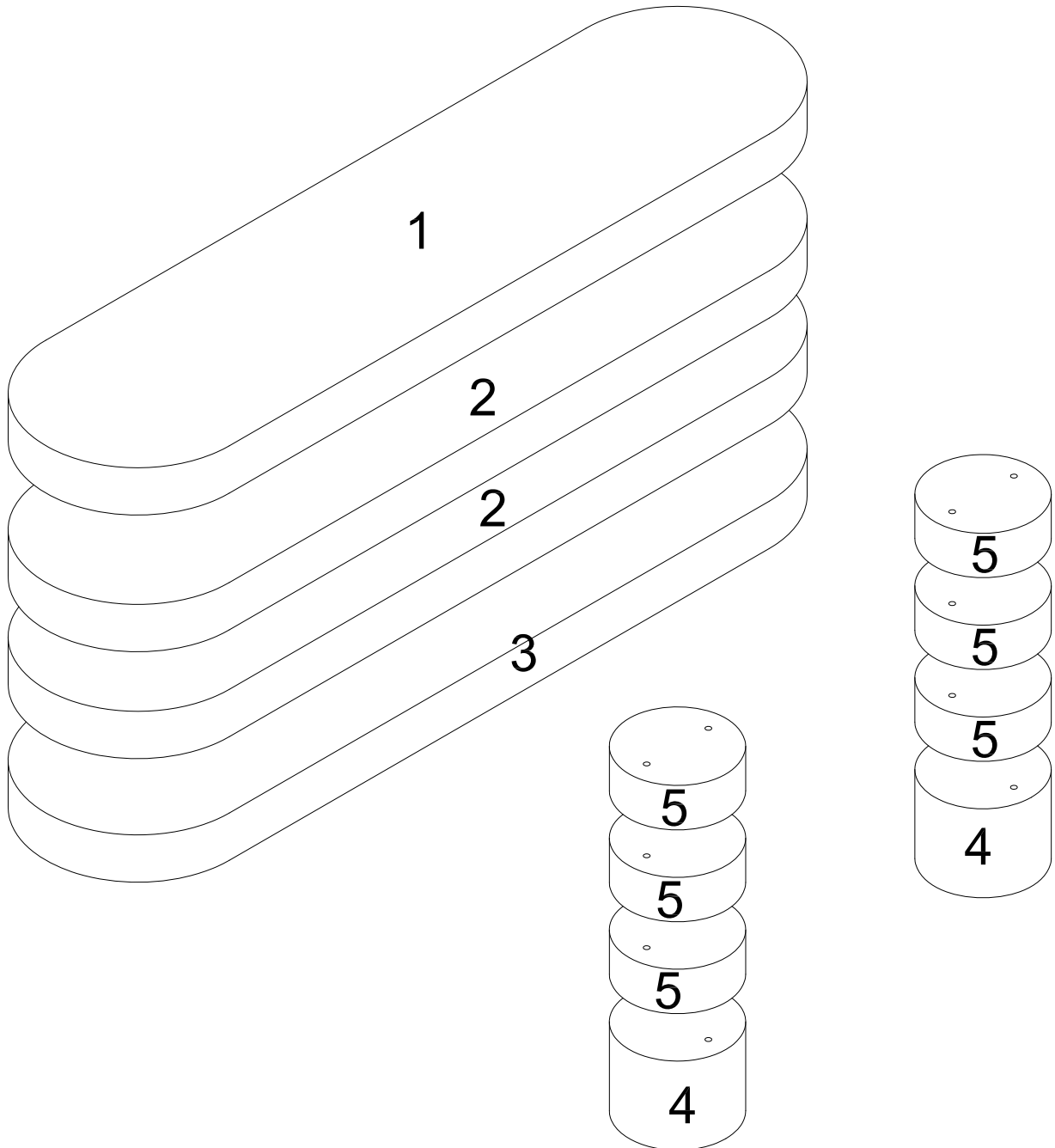

# STEP 1

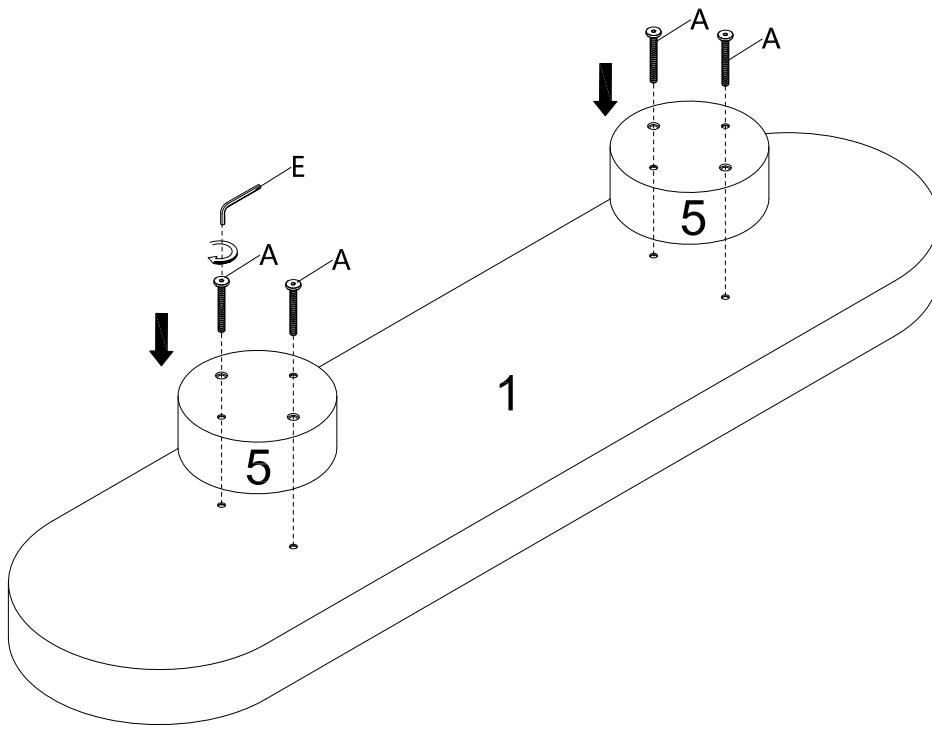

No. A  
Quantity: 4 Pcs



No. E  
Quantity: 1 Pc



# STEP 2

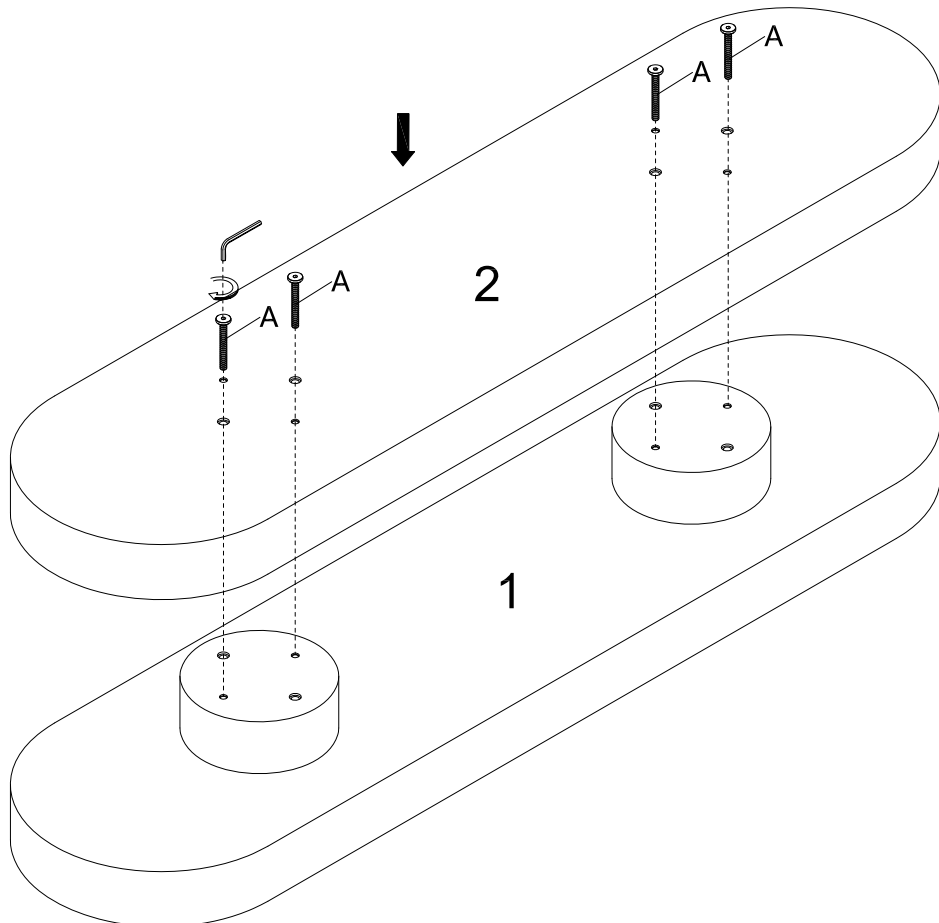

No. A  
Quantity: 4 Pcs

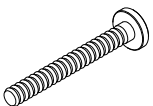

STEP 3

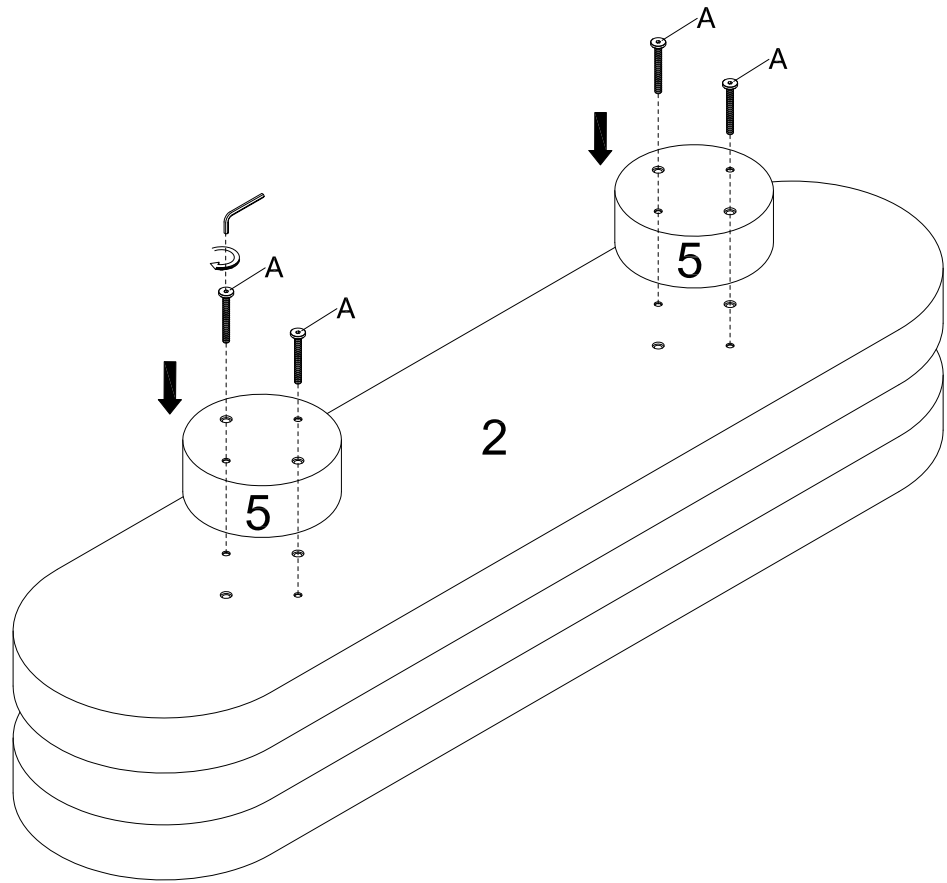

No. A

Quantity: 4 Pcs

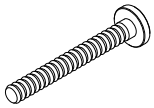

STEP 4

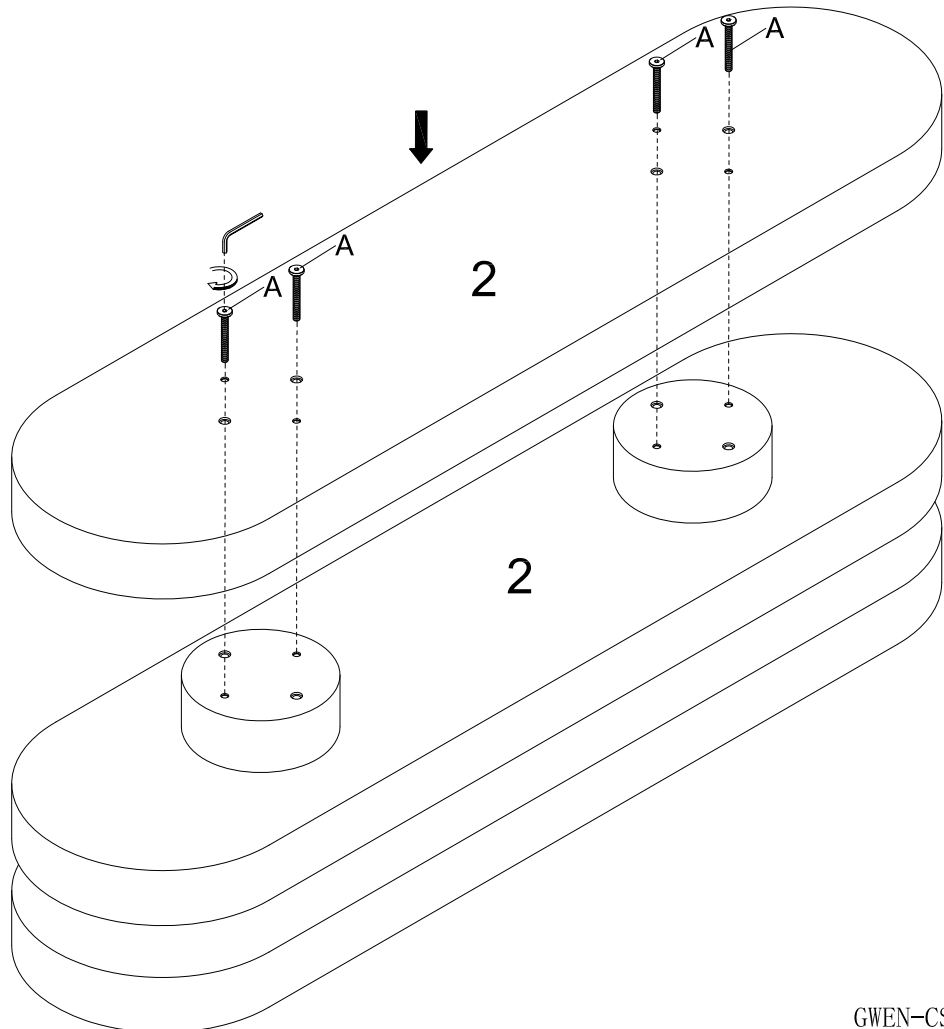

No. A

Quantity: 4 Pcs



# STEP 5

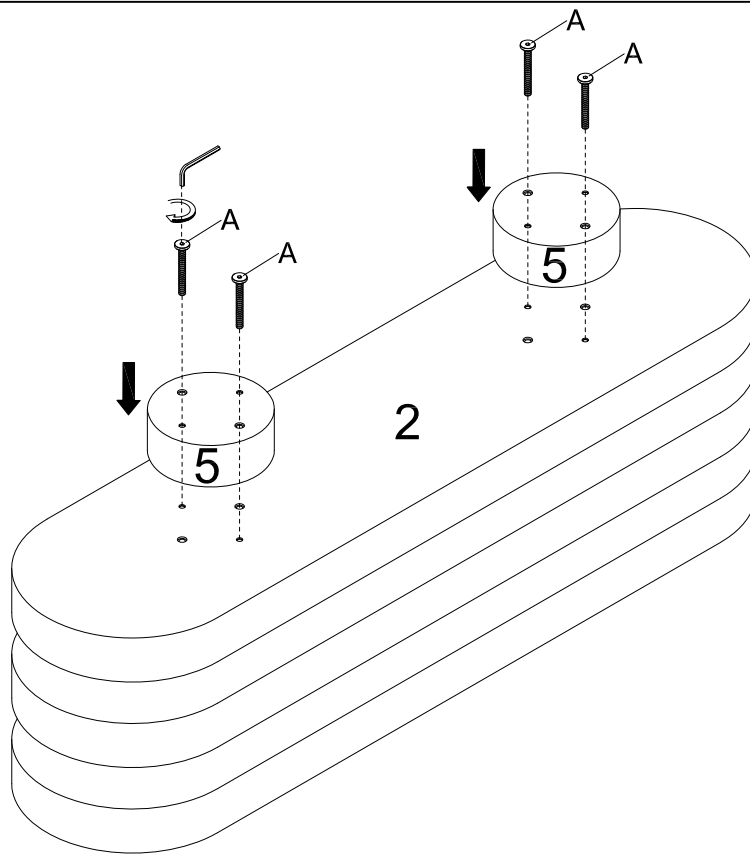

No. A

Quantity: 4 Pcs



# STEP 6

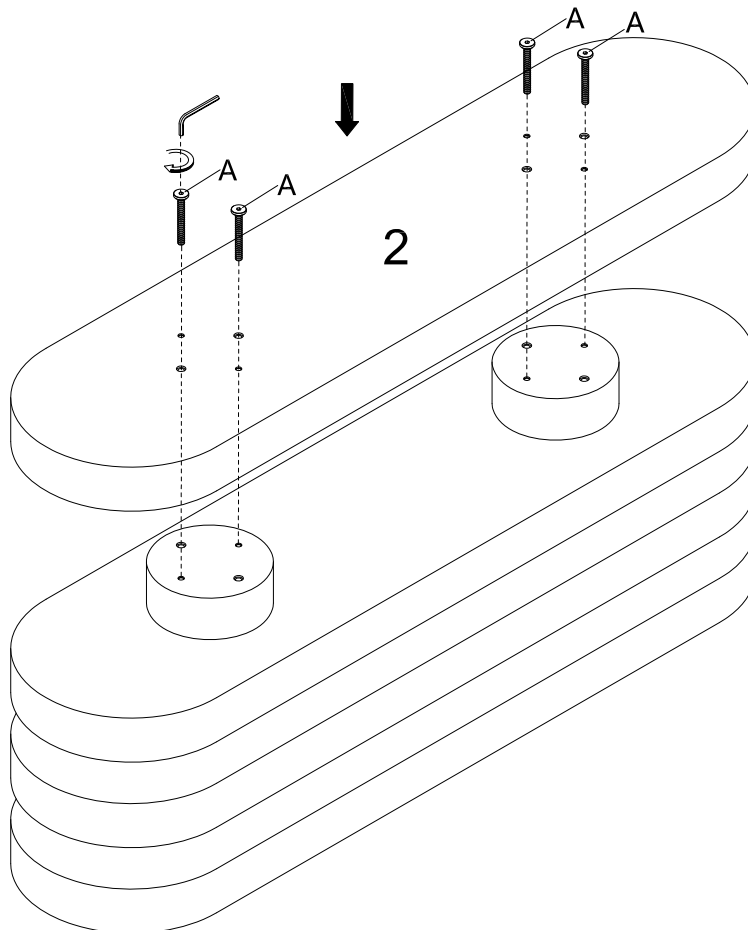

No. A

Quantity: 4 Pcs

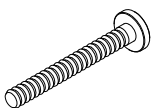



# STEP 7

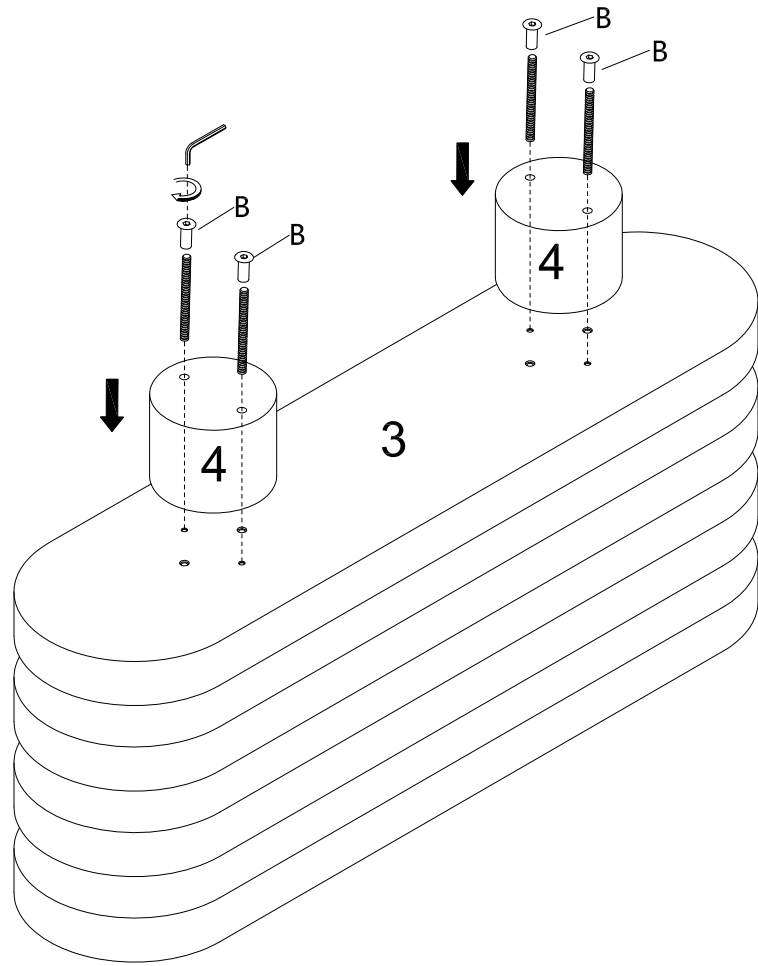

No. B  
Quantity: 4 Pcs

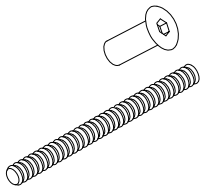

# STEP 8

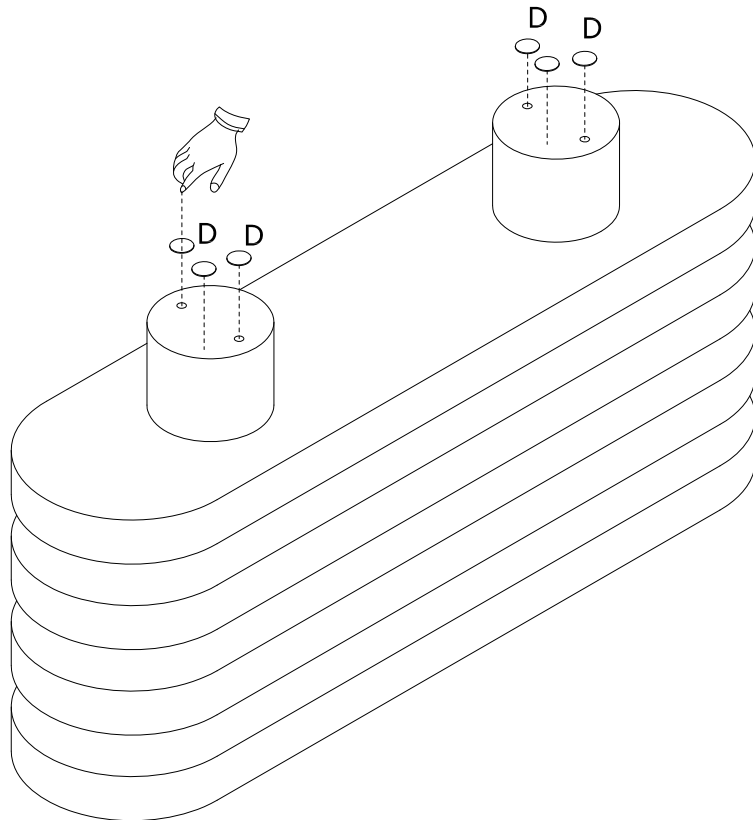

No. D  
Quantity: 6 Pcs



# STEP 9

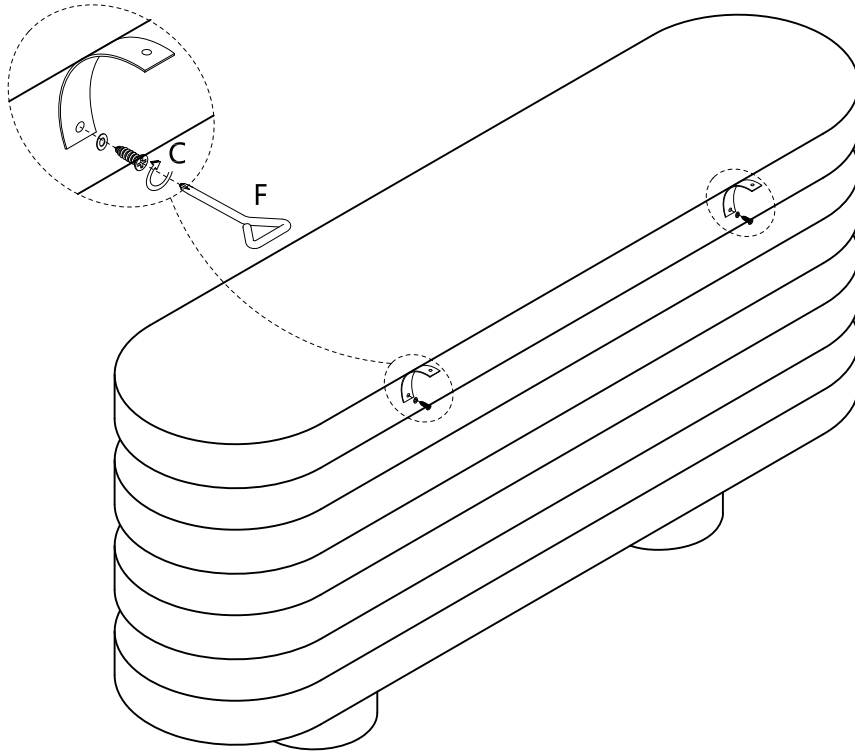

No. C

Quantity:2 Pcs



No. F

Quantity:1 Pc



# STEP 10

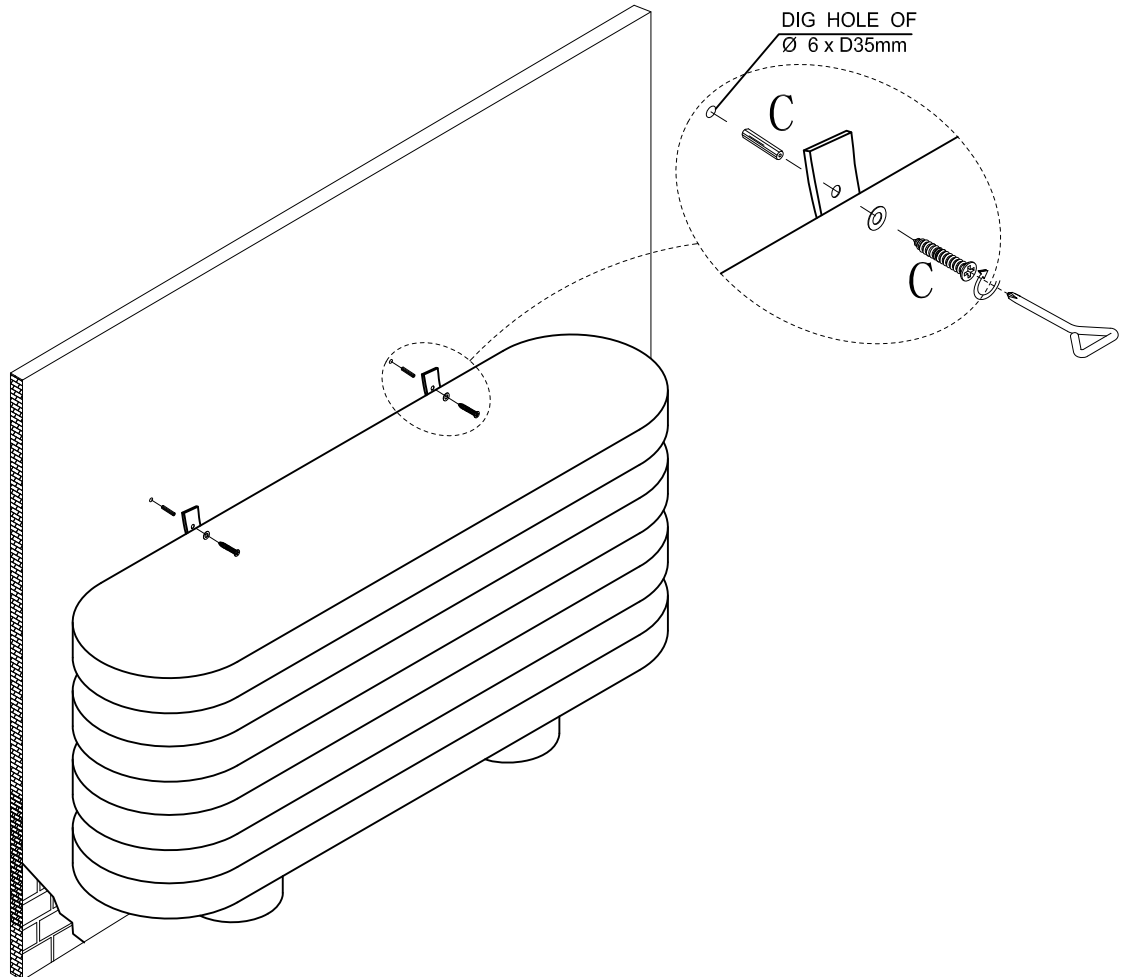

DIG HOLE OF  
Ø 6 x D35mm

No. C

Quantity:2 Pcs



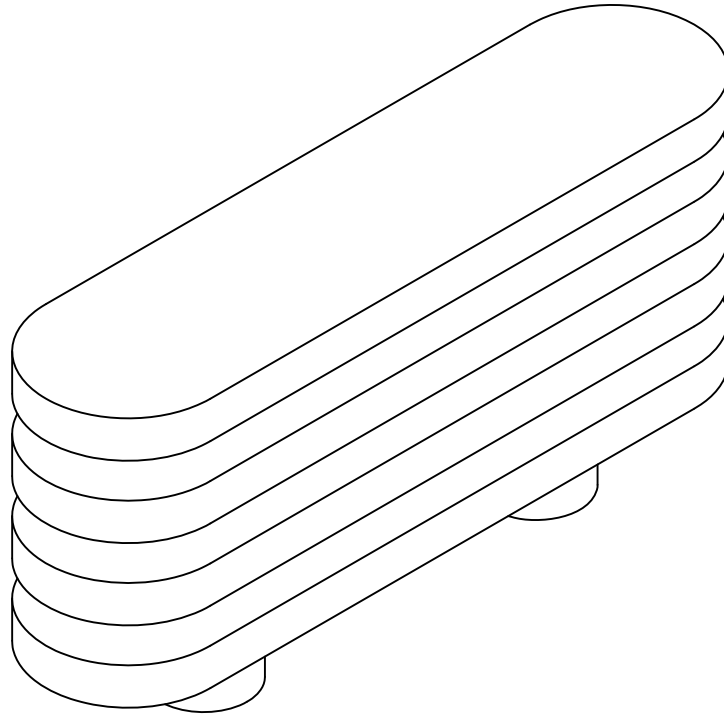

**TOPPLING FURNITURE WARNING:**

- **It is strongly recommended that this product is permanently fixed to the wall.**
- **Please seek professional advice if you are in doubt of what fixing device to use.**
- **Regularly check that anchors are securely maintained.**
- **Stability of tall items may be affected by thick pile carpet or uneven floors .**
- **Do not place unanchored televisions on furniture .**

**CAUTION:** for your safety when attaching the anchor fixings, please note the following:

- **Check any electrical wires or plumbing inside the wall before drilling any holes (if you are unsure please seek professional advice from a qualified tradesperson).**



**WARNING: PLEASE SECURE YOUR FURNITURE WITH THE SUPPLIED WALL FIXING. SCAN THE CODE FOR MORE INFORMATION.**



lifely.com.au

Great job. You're done!

Don't forget to share how it looks in  
your space and tag us on Instagram.

@lifelyhome #homewithlifely!