



PONDMASTER **ProLine** **Supreme AQUARIUM** **Supreme HYDRO** **POOLCARE**





A HISTORY OF EXCELLENCE.

IMPROVING THE ART OF FLUID MOTION™ FOR ALMOST 90 YEARS.

Ever since our modest beginnings, Danner Manufacturing, a family owned and operated business, has developed and produced innovative products for hobbyists and professionals alike.

Eugene Danner Sr. started planting the seeds for Danner Manufacturing in 1934 while working in the cellar of his home on Seneca Avenue in the Ridgewood district of Brooklyn, New York. While holding a full-time job as a factory manager, Eugene found great pride creating the Danner business on his time off from his regular full-time job duties. Eugene's first product was a small waterfall toy, which was used as a component in a toy sold by the world famous F•A•O Schwarz® toy store in New York City. Eugene Danner Sr. along with his children, Eugene and Renate, would travel from Brooklyn to Canal Street in Manhattan where they would purchase scrap metal for these waterfall toys.



Eugene Danner Sr. with his son, Eugene Danner and company Employee. Circa 1958



Eugene Danner Sr. Summerfield St. Brooklyn, NY Factory. Circa 1968

Around that time, the aquatics hobby began to grow and people who kept fish as pets were known as "Fish Fanciers." Eugene was often asked if he could make water and air pumps for this new-found hobby. From there, the "Supreme Aquarium" brand was born and the original Supreme Dynamaster® Air Pumps were introduced, which quickly became the standard to which others aspired.

At the end of World War II, Eugene's son came home from active duty and opened the first official Danner Manufacturing factory on Woodbine Street in Brooklyn. He took on his father's growing hobby as a full time business. At this time, Eugene Danner Sr. quit his job as a factory manager and started working full-time with his son to formulate what is now known as Danner Manufacturing. As the years progressed, Eugene and his son upgraded and opened up a new state-of-the-art factory in 1960 on Summerfield Street in Brooklyn.

In the 1960's, all three of Eugene Danner Sr's grandchildren started helping in the factory and in 1974 the Danner family moved its operations to a new facility in Islandia, NY. In 1987, Eugene passed the torch onto his son, Michael who ran the business until 2005. During this time, Michael's sister, Catherine Danner designed and developed many award-winning package designs throughout the 1980's. Their sister, Rosemarie is the current CEO of Danner Manufacturing and continues to carry on the great Danner legacy and tradition.

Almost 90 years later, continuing with Eugene Danner Sr's vision, Danner Manufacturing still employs and manufactures within the United States. Our sophisticated and energy-efficient magnetically driven and hybrid pumps continue to be popular products with thousands of satisfied and loyal customers all over North America.

The brands which we manufacture and market are: Supreme Aquarium, Pondmaster, Proline, Supreme Hydro, Pool-Care, Pondmaster ECO and the Danner Home Collection. These brands can be found in the Aquarium, Water Gardening, Pond, Pool & Spa, Hydroponic, Home and OEM industries throughout North America and the offshore markets. We are committed to providing our customers with high quality and reasonably priced products, creating the best value.



THE DANNER HOME COLLECTION line of fountains bring relaxation to a whole new level. From small table-top fountains to large outdoor fountains, these decorative designs bring a calm, zen-like feeling to any home or workspace. See pages 94-100



Page 94-100

THE DANNER HOME COLLECTION line of cat and dog products offer everything from cat toys to stylish dog bowls and portable pet water bottles to ceramic pet fountains. See pages 102-106



Page 102-106

FOLLOW US





TABLE OF CONTENTS

PONDMASTER

PUMPS

- Pondmaster Pond-Mag[®] Magnetic Drive Water Pumps 5-7
- Pondmaster Hydro-Air[®] Submersible Water & Air Pump 8
- Pondmaster Waterfall/Skimmer Pumps 9
- Pondmaster Fountain-Mag[®] Magnetic Drive Water Pumps 10
- The Fountain Pump Fountain & Statuary Water Pumps..... 11
- Pondmaster Hy-Drive Water Pumps 12

PRESSURIZED FILTERS, UV CLARIFIERS, FILTRATION SYSTEMS AND POND KITS

- Pondmaster CPF Series Pressurized Filters 13
- Pondmaster Clearguard Pressurized Filter 14-16
- Pondmaster Clearguard UV Clarifier Kit, Backwash Air Kit and Accessories 17-18
- Pondmaster Ultraviolet Clarifiers 19
- Pondmaster Filtration Systems 20
- Pondmaster Pond Kits 21

AIR PUMPS

- Pondmaster Air Pumps and Pond Aeration Kit 22

PUMP TREATMENTS, CLEANERS AND FOOD

- Pondmaster PumpGuard 23
- Pondmaster Pond-Clean and Pondmaster Koi Food 24
- Danner Water Treatments 26

ACCESSORIES AND REPLACEMENT PARTS

- Pondmaster Fountain Head Kits and Disappearing Fountain Basin 27
- Pondmaster LED Lighted Spillway 28
- Pondmaster LED Light Ring Kits and Pondmaster Photosensor LED Lights 29
- Pondmaster Spouting Pond Statues..... 30
- Pondmaster De-Icer, Floating Pond Thermometer, Air Diffusers and Aquatic Plant Basket 31
- Pondmaster Super-Flex Pond Liners..... 32
- Pondmaster Pond Netting and Pond Nets 33
- Pondmaster Tubing, Pump Bags and Barb Fittings..... 34
- Pondmaster Replacement Filter Media and Impellers 35-36

PONDMASTER ECO

PUMPS

- Pondmaster Eco Submersible Water Pumps..... 39-40
- Pondmaster Eco Fountainhead & Pump Kits..... 41-42

ProLine

PRESSURIZED FILTERS

- ProLine Pressurized Filters 45-46

PUMPS

- ProLine HFS Submersible Water Pumps 47
- ProLine Hy-Drive Water Pumps 48
- ProLine Skimmer Pumps with Hy-Drive Technology 49

SKIMMERS, FILTER AND FALLS, PUMP VAULTS AND WATER FEATURES

- ProLine Pro1000, Pro2000, Pro3000 Filter and Falls 50
- ProLine Pro5000 Filter and Falls and Pro5000 Skimmer 51
- ProLine Pump Vaults 52
- ProLine App-Controlled Multi-Color LED Spillways 53-54

Supreme AQUARIUM

PUMPS

- Supreme Aqua-Mag[®] Magnetic Drive Water Pumps..... 57
- Supreme Aqua-Mag[®] Air Fractionating Water Pumps..... 58
- The Aquarium Pump 59
- Supreme Hy-Drive Water Pumps 60

FILTERS

- Supreme EZ Clean External Aquarium Filter 61
- Supreme EZ Clean Internal Aquarium Filter 62
- Supreme Skilter Protein Skimmer and Aerating Power Filter..... 63
- Supreme Ovation Submersible Power Jet Filters 64

AIR PUMPS

- Supreme Oxy-Flo Aquarium Air Pumps 65-66

PUMP TREATMENTS

- Supreme Pumpguard and Aqua-Clean..... 67

REPLACEMENT PARTS AND ACCESSORIES

- Supreme Replacement Filter Media, Impellers, Airstones, Tubing and Check Valves..... 68

Supreme HYDRO

PUMPS

- Supreme Hydro-Mag[®] Recirculating Water & Air Pumps..... 71
- Supreme Hy-Drive Recirculating Water Pumps..... 72
- Hydro-Air[®] Submersible Water & Air Pump..... 73
- The Growers Pump..... 74
- Supreme Cloning Pump with Spray Head 75

DE-WATERING PUMPS

- Supreme De-Watering Pumps 76

AIR PUMPS

- Supreme Oxy-Flo Air Pumps 77-78

PUMP TREATMENTS

- Supreme Hydro-Clean 79

ACCESSORIES AND REPLACEMENT PARTS

- Air Diffusers and Supreme Ebb & Flow Kit 80
- Air Stones, Tubing and Check Valves..... 81
- Replacement Parts..... 82

POOL-CARE

PUMPS

- Cover-Care Magnetic Drive Pool Cover Pumps & Automatic Pool Cover Pump 85-86

DE-WATERING PUMPS

- Pool-Care Main Drain Utility/Pool Pump 87
- Pool-Care 6MSP Utility/Pool Pump 88

DECORATIVE WATER FEATURES

- Pool-Care App-Controlled Multi-Color LED Spillway..... 89-90



FOUNTAINS

- Danner Home Collection Outdoor/Indoor Fountains 94
- Danner Home Collection Meditation Fountains 95-97
- Danner Home Collection Damien Limited Edition Tabletop Fountain 98
- Danner Home Collection Shelly Tabletop Fountain 99
- Danner Home Collection Ceramic Pet Fountains 100

DOG BOWLS

- Danner Home Collection Stainless Steel, Anti-Skid Dog Bowls 102

PET TRAVEL WATER BOTTLES

- Danner Home Collection Portable Pet Travel Water Bottles 103

CAT TOYS

- Danner Home Collection Polaris Interactive Cat Toys 104
- Danner Home Collection Crazy Butterfly Interactive Cat Toys 105
- Danner Home Collection Flower Power Interactive Cat Toy and Froggo Cat Toy 106

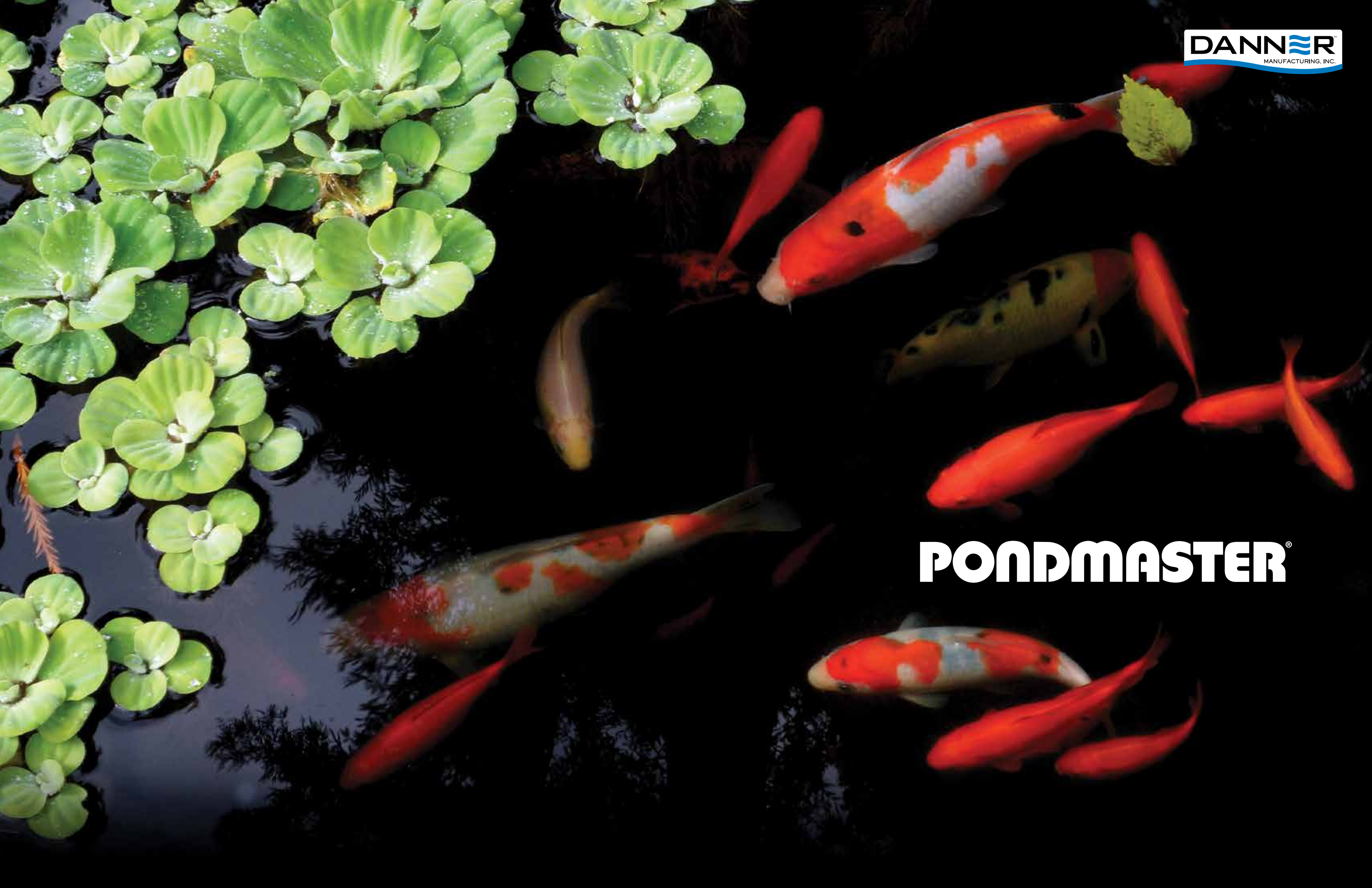

PONDMASTER®

PONDMASTER POND-MAG® MAGNETIC DRIVE WATER PUMPS

PONDMASTER POND-MAG® 250 to 3600 SERIES PUMPS have been designed to handle virtually any application where water has to be moved. They've been fulfilling the needs of professionals and consumers for decades with quiet, efficient and reliable 24/7 performance. They feature a magnet impeller assembly and an epoxy encased power unit ensuring that water never gets contaminated with harmful oils or chemicals.



THE ANATOMY OF A PONDMASTER POND-MAG® MAGNETIC DRIVE WATER PUMP

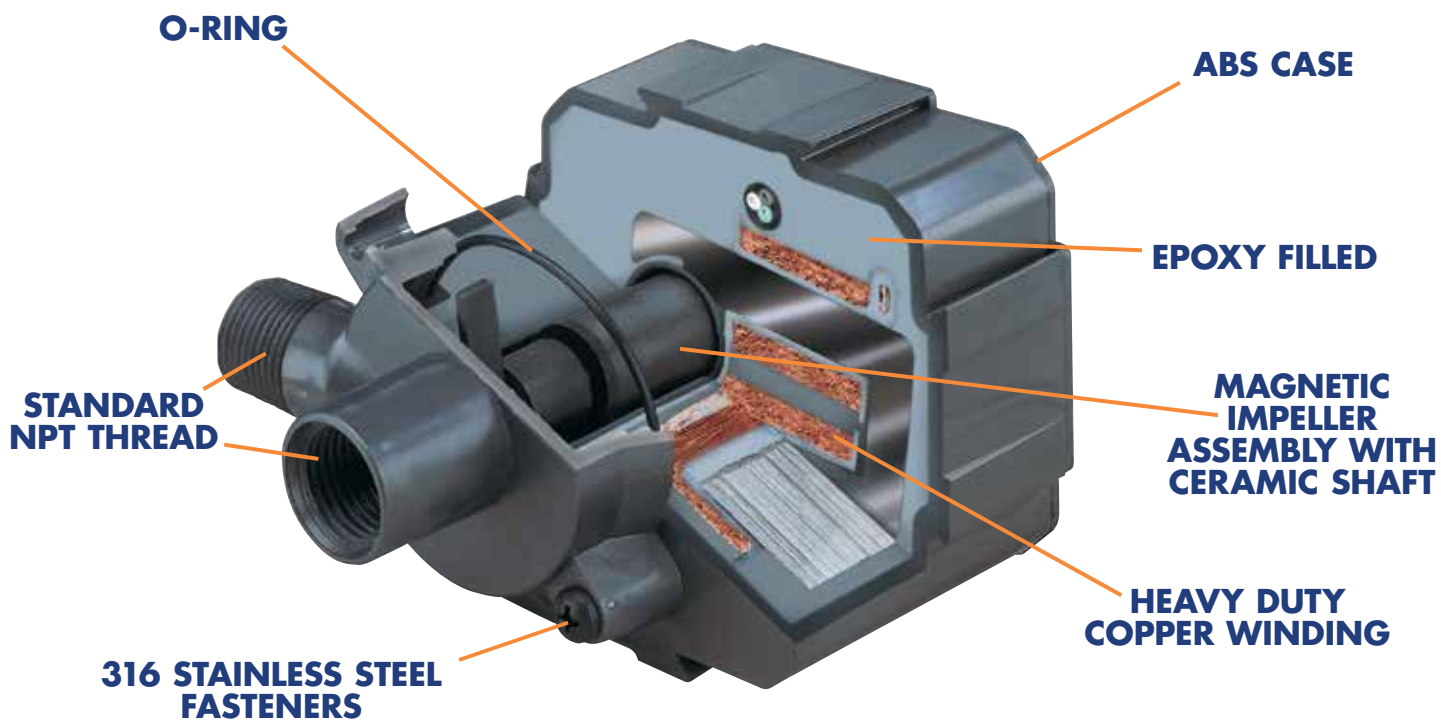

PONDMASTER POND-MAG® MAGNETIC DRIVE WATER PUMPS

PONDMASTER®

POND-MAG 250 THROUGH 700 GPH PUMPS ARE GREAT FOR SMALL TO MEDIUM SIZED PONDS BETWEEN 150 AND 550 GALLONS.

FEATURES

- 5 Year Limited Warranty
- Rigid Pre-Filter Included
- Ceramic Shaft
- 18' Grounded Power Cord
- PM 250 through 700 Made in USA
- Operates Submerged or Inline
- Packed 6 per Master Carton (250 to 700)



PM 250 • ITEM# 02522

Max. Watts/Amps	24/0.4
Inlet	1/2" FPT
Outlet	1/2" MPT
Cord Length	18'
Dimensions (L x W x H)	5" x 3.8" x 4.2"

PM 500 • ITEM# 02525

Max. Watts/Amps	45/0.9
Inlet	1/2" FPT
Outlet	1/2" MPT
Cord Length	18'
Dimensions (L x W x H)	5" x 3.8" x 4.2"

PM 350 • ITEM# 02523

Max. Watts/Amps	35/0.6
Inlet	1/2" FPT
Outlet	1/2" MPT
Cord Length	18'
Dimensions (L x W x H)	5" x 3.8" x 4.2"

PM 700 • ITEM# 02527

Max. Watts/Amps	70/1.6
Inlet	1/2" FPT
Outlet	1/2" MPT
Cord Length	18'
Dimensions (L x W x H)	5" x 3.8" x 4.2"

Model	Item #	Watts	Flow at 1'	Flow at 2'	Flow at 3'	Flow at 4'	Flow at 5'	Flow at 6'	Flow at 7'	Flow at 8'	Flow at 9'	Flow at 10'	Shut-Off (Feet)
PM 250	02522	24	280	230	170	130	65	25	-	-	-	-	6' 5"
PM 350	02523	35	420	375	325	280	235	190	140	90	30	-	10' 4"
PM 500	02525	45	525	450	400	350	300	235	200	150	95	-	10' 6"
PM 700	02527	70	655	605	565	530	450	420	325	275	200	110	11' 8"

Suggested pond size/gallon recommendations do not include any water features such as waterfalls or streams.

PONDMASTER POND-MAG[®] MAGNETIC DRIVE WATER PUMPS

POND-MAG 950 THROUGH 1800 GPH PUMPS ARE GREAT FOR PONDS BETWEEN 850 AND 1,100 GALLONS.

PM 950 • ITEM# 02720

Max. Watts/Amps	93/1.33
Inlet	¾" FPT
Outlet	¾" MPT
Cord Length	18'
Dimensions (L x W x H)	5" x 3" x 5.25"

PM 1200 • ITEM# 02722

Max. Watts/Amps	110/1.5
Inlet	¾" FPT
Outlet	¾" MPT
Cord Length	18'
Dimensions (L x W x H)	6.4" x 3" x 5.25"

PM 1800 • ITEM# 02728

Max. Watts/Amps	145/1.55
Inlet	¾" FPT
Outlet	¾" MPT
Cord Length	18'
Dimensions (L x W x H)	6.4" x 3" x 5.25"

POND-MAG 2400 AND 3600 GPH PUMPS ARE GREAT FOR LARGE PONDS BETWEEN 2,000 AND 2,600 GALLONS.

PM 2400 • ITEM# 02750

Max. Watts/Amps	237/2.2
Inlet	1" FPT
Outlet	1" MPT
Cord Length	18'
Dimensions (L x W x H)	7.25" x 4.0" x 6"

PM 3600 • ITEM# 02755

Max. Watts/Amps	256/3.0
Inlet	1" FPT
Outlet	1" MPT
Cord Length	18'
Dimensions (L x W x H)	7.25" x 4.0" x 6"

FEATURES

- 5 Year Limited Warranty
- Rigid Pre-Filter Included
- Ceramic Shaft
- 18' Grounded Power Cord
- Operates Submerged or Inline
- Packed 2 per Master Carton (950 to 3600)



PM 950



PM 3600



Model	Item #	Watts	Flow at 1'	Flow at 2'	Flow at 3'	Flow at 4'	Flow at 5'	Flow at 6'	Flow at 7'	Flow at 8'	Flow at 9'	Flow at 10'	Flow at 15'	Shut-Off (Feet)
PM 950	02720	93	1010	930	900	840	770	710	650	600	530	475	-	13' 7"
PM 1200	02722	110	1190	1130	1065	940	900	840	795	730	630	570	-	13' 7"
PM 1800	02728	145	1300	1240	1170	1130	1040	1015	925	880	810	775	470	16' 6"
PM 2400	02750	237	2400	2350	2190	2030	1860	1730	1645	1510	1395	1380	830	17' 1"
PM 3600	02755	256	3060	2885	2775	2670	2595	2480	2365	2295	2205	2170	1615	22' 6"

Suggested pond size/gallon recommendations do not include any water features such as waterfalls or streams.

PONDMASTER HYDRO-AIR[®] SUBMERSIBLE WATER & AIR PUMP

PONDMASTER

THE PONDMASTER HYDRO-AIR SUBMERSIBLE WATER & AIR PUMP IS THE ONLY PUMP OF ITS KIND THAT ACTUALLY MARRIES THE FEATURES OF A TRADITIONAL WATER PUMP WITH THOSE OF AN AIR PUMP, ALL IN ONE COMPACT UNIT.

FEATURES

- One Electrical Outlet needed for both Water and Air
- Custom Diffuser disperses a wide band of Air Bubbles
- Ceramic Shaft
- Pumps up to 1400 Gallons per hour
- Aerates Ponds up to 1,000 Gallons
- Can be used in depths up to 2-Feet
- Oil-Free / Fish-Safe
- (2) Pre-Filters Included
- 8 ¼" L x 3 ¾" W x 5 ½"H without Diffuser (6 ½" H with Diffuser)
- 18' Grounded Power Cord
- 1 Year Limited Warranty

HYDRO-AIR SUBMERSIBLE WATER & AIR PUMP ITEM# 02795

- 17 Ft. Shut-Off with 1-1/2" Tubing
- 16 Ft. Shut-Off with 2" Tubing
- 120 Volts AC, 60 HZ, 199 Watts, 3.7 Amps.

ON WATER PUMP SIDE

- ¾" FPT Inlet
- ¾" MPT Outlet

ON AIR PUMP SIDE

- Requires ½" Flexible PVC Tubing on the Inlet (sold separately)
- Air Diffuser on the Outlet (included)



PATENTED TECHNOLOGY PROVIDES ALL-IN-ONE CHOICE FOR WATER MOVEMENT AND AERATION

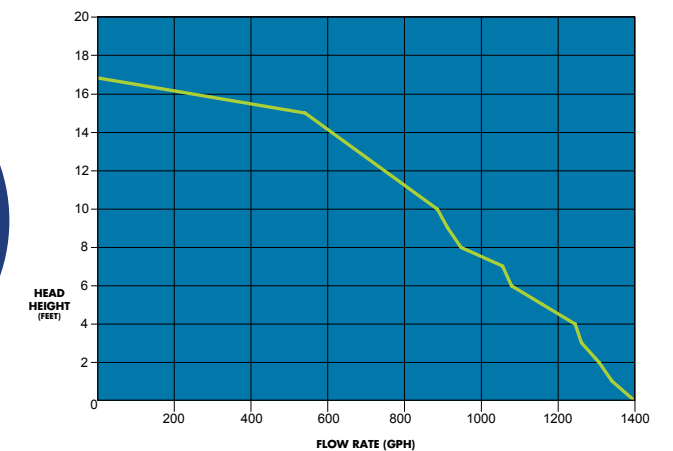

SUBSCRIBE TO OUR YOUTUBE CHANNEL AND VIEW OUR HYDRO-AIR PRODUCT VIDEO!
WWW.YOUTUBE.COM/DANNERMFG

PONDMASTER WATERFALL/SKIMMER PUMPS

PONDMASTER MAGNETIC DRIVE WATERFALL/SKIMMER PUMPS ARE HIGHLY EFFICIENT PUMPS FEATURING RELIABLE CERAMIC BEARINGS DELIVERING UP TO 3000 GPH; Enough to create a dynamic, attractive waterfall or drive a medium to large size skimmer.

FEATURES

- Designed for Use in Skimmers, Waterfalls and Large Pond Installations
- Powerful, Efficient Magnetic Drive Motor
- Oil-Free / Fish Safe
- Continuous Duty Operation
- Completely Submersible
- Extra-Large, Clog-Resistant Filter Screen
- Back-Flow Check Valve and 1/2" Fittings Supplied
- 20' Power Cord with Grounded Plug
- Replacement Impeller Available
- Packed 2 per Master Carton
- 1 Year Limited Warranty

2000 GPH • ITEM# 02650 SUBMERSIBLE WATERFALL PUMP

Max. Flow Rate	2000 GPH
Max. Pumping Height	13'
Max. Watts/Amps	145/2.1
Weight	9 lbs.
Dimensions (L x W x H)	7.5" x 7.5" x 11.25"

3000 GPH • ITEM# 02660 SUBMERSIBLE WATERFALL PUMP

Max. Flow Rate	3000 GPH
Max. Pumping Height	15'
Max. Watts/Amps	250/2.3
Weight	11 lbs.
Dimensions (L x W x H)	7.5" x 7.5" x 11.25"

DESIGNED FOR USE IN SKIMMERS AND WATERFALLS



Model	Item #	Watts	Flow at 1'	Flow at 2'	Flow at 3'	Flow at 4'	Flow at 5'	Flow at 6'	Flow at 7'	Flow at 8'	Flow at 9'	Flow at 10'	Shut-Off (Feet)
SWFP 2000	02650	145	1836	1416	1374	1230	1086	1026	942	828	744	654	13'2"
SWFP 3000	02660	250	2022	1938	1866	1782	1644	1560	1470	1356	1242	1110	14'6"



PONDMASTER FOUNTAIN-MAG™ MAGNETIC DRIVE WATER PUMPS

PONDMASTER

PONDMASTER FOUNTAIN-MAG™ PUMPS ARE A MUST FOR ANY RETAILER'S LINEUP. Models 35 and 65 GPH are perfect for table top fountains; Models 65 and 80 GPH are great for small garden fountains, piped statuary and shallow water conditions; Model 190 GPH is suitable for small to medium size fountains, piped statuary and small ponds.

FEATURES

- Built-In Adjustable Flow Control
- Foam Pre-Filter (Not Included in 35 GPH and 65 GPH Models)
- Grounded Power Cords
- Packed 4 Per Master Carton
- 1 Year Limited Warranty on Models 35 GPH Thru 140 GPH
- 5 Year Limited Warranty on Model 190 GPH

GREAT FOR FOUNTAINS AND STATUARY

MINI 35 GPH • ITEM# 02501

Max. Watts/Amps	5.0/0.04
Inlet	No Thread
Outlet	1/2"
Cord Length	6'
Dimensions (L x W x H)	1.9" x 1.4" x 1.69"

For Submersed Use Only



65 GPH FOUNTAIN-MAG • ITEM# 02510

Max. Watts/Amps	5.75/0.06
Inlet	No Thread
Outlet	5/8" or 1/2"
Cord Length	6'
Dimensions (L x W x H)	2.5" x 1.8" x 2.8"

For Submersed Use Only



80 GPH FOUNTAIN-MAG • ITEM# 02520

Max. Watts/Amps	8.5/0.1
Inlet	No Thread
Outlet	3/8" or 1/2"
Cord Length	6'
Dimensions (L x W x H)	2.9" x 2.2" x 2.7"

For Submersed Use Only



140 GPH FOUNTAIN-MAG • ITEM# 02521

Max. Watts/Amps	12.0/0.1
Inlet	No Thread
Outlet	3/8" or 1/2"
Cord Length	6'
Dimensions (L x W x H)	2.9" x 2.2" x 2.7"

For Submersed Use Only



190 GPH FOUNTAIN-MAG ITEM# 02519

Max. Watts/Amps	19.0/0.3
Inlet	3/8" MPT
Outlet	1/4"
Cord Length	10'
Dimensions (L x W x H)	2.5" x 1.8" x 2.8"

Use Submerged or In-Line



02519 In-line (without cover)



02519 Submerged (with cover)



PUMPING SPECIFICATIONS									
Model	Item #	Watts	Flow at 1'	Flow at 2'	Flow at 3'	Flow at 4'	Flow at 5'	Flow at 6'	Shut-off (Feet)
35 GPH	02501	5.0	22	-	-	-	-	-	2'
65 GPH	02510	5.75	40	-	-	-	-	-	2'
80 GPH	02520	8.5	45	17	-	-	-	-	2' 6"
140 GPH	02521	12.0	120	80	60	40	30	-	6'
190 GPH	02519	19.0	167	140	125	93	68	34	7'

THE FOUNTAIN PUMP FOUNTAIN & STATUARY WATER PUMPS



THE FOUNTAIN PUMP FEATURES A VERTICAL FLOW CONTROL AND IS DESIGNED FOR FOUNTAINS, STATUARY AND SMALL PONDS.

FEATURES

- Vertical Flow Control Design Increases Flow Range
- Models 70 thru 200 for Submersible Use Only
Models 290 thru 725 for Submersible or In-line Use
- 6' Grounded Power Cord on 70 - 120 GPH Pumps
- 6' or 15' Grounded Power Cord on 200 - 725 GPH Pumps
- 2 Year Limited Warranty

70 GPH FOUNTAIN PUMP • ITEM# 01703

Max. Flow Rate	70 GPH
Max. Pumping Height	2'
Cord Length	6'
Power	115V, 60Hz
Dimensions (L x W x H)	2" x 1 3/4" x 1 3/4"
Includes Tubing Adaptors	1/4" and 1/2"

93 GPH FOUNTAIN PUMP • ITEM# 01707

Max. Flow Rate	93 GPH
Max. Pumping Height	2.5'
Cord Length	6'
Power	115V, 60Hz
Dimensions (L x W x H)	2 5/8" x 1 1/2" x 2 3/8"
Includes Tubing Adaptors	1/4" and 1/2"

120 GPH FOUNTAIN PUMP • ITEM# 01713

Max. Flow Rate	120 GPH
Max. Pumping Height	3'
Cord Length	6'
Power	115V, 60Hz
Dimensions (L x W x H)	2 3/4" x 1 5/8" x 2 1/2"
Includes Tubing Adaptors	1/4" and 1/2"

200 GPH FOUNTAIN PUMP • ITEM# 01717

Max. Flow Rate	200 GPH
Max. Pumping Height	5.5'
Cord Length	6' or 15'
Power	115V, 60Hz
Dimensions (L x W x H)	3 1/8" x 2" x 3"
Includes Tubing Adaptors	1/4" and 1/2"

290 GPH FOUNTAIN PUMP • ITEM# 01721

Max. Flow Rate	290 GPH
Max. Pumping Height	6.5'
Cord Length	6' or 15'
Power	115V, 60Hz
Dimensions (L x W x H)	4 5/8" x 3" x 3 1/2"
Includes Tubing Adaptors	1/2", 5/8" and 3/4"

400 GPH FOUNTAIN PUMP • ITEM# 01727

Max. Flow Rate	400 GPH
Max. Pumping Height	8.5'
Cord Length	6' or 15'
Power	115V, 60Hz
Dimensions (L x W x H)	4 3/8" x 2 5/8" x 3 1/8"
Includes Tubing Adaptors	1/2", 5/8" and 3/4"

530 GPH FOUNTAIN PUMP • ITEM# 01733

Max. Flow Rate	530 GPH
Max. Pumping Height	9'
Cord Length	6' or 15'
Power	115V, 60Hz
Dimensions (L x W x H)	4 1/2" x 2 3/4" x 3 1/4"
Includes Tubing Adaptors	1/2", 5/8" and 3/4"

725 GPH FOUNTAIN PUMP • ITEM# 01739

Max. Flow Rate	725 GPH
Max. Pumping Height	12'
Cord Length	6' or 15'
Power	115V, 60Hz
Dimensions (L x W x H)	4 1/2" x 3" x 3 1/2"
Includes Tubing Adaptors	1/2", 5/8" and 3/4"

290 GPH FOUNTAIN PUMP • ITEM# 01723

Max. Flow Rate	290 GPH
Max. Pumping Height	6.5'
Cord Length	6' or 15'
Power	115V, 60Hz
Dimensions (L x W x H)	4 5/8" x 3" x 3 1/2"
Inlet Size	1/2" Male NPS
Includes Tubing Adaptors	1/2", 5/8" and 3/4"

400 GPH FOUNTAIN PUMP • ITEM# 01727

Max. Flow Rate	400 GPH
Max. Pumping Height	8.5'
Cord Length	6' or 15'
Power	115V, 60Hz
Dimensions (L x W x H)	4 3/8" x 2 5/8" x 3 1/8"
Inlet Size	1/2" Male NPS
Includes Tubing Adaptors	1/2", 5/8" and 3/4"

530 GPH FOUNTAIN PUMP • ITEM# 01733

Max. Flow Rate	530 GPH
Max. Pumping Height	9'
Cord Length	6' or 15'
Power	115V, 60Hz
Dimensions (L x W x H)	4 1/2" x 2 3/4" x 3 1/4"
Inlet Size	1/2" Male NPS
Includes Tubing Adaptors	1/2", 5/8" and 3/4"

725 GPH FOUNTAIN PUMP • ITEM# 01737

Max. Flow Rate	725 GPH
Max. Pumping Height	12'
Cord Length	6' or 15'
Power	115V, 60Hz
Dimensions (L x W x H)	4 1/2" x 3" x 3 1/2"
Inlet Size	1/2" Male NPS
Includes Tubing Adaptors	1/2", 5/8" and 3/4"

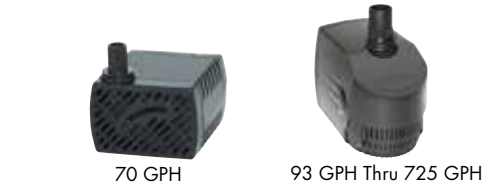

Pump	Flow at 0'	Flow at 2'	Flow at 4'	Flow at 6'	Flow at 8'	Shut-Off	Watts	Amps
SP-70	70	-	-	-	-	2'	3W	.03A
SP-93	93	20	-	-	-	2.5'	6W	.07A
SP-120	120	50	-	-	-	3'	6.5W	.08A
SP-200	200	140	85	35	-	5.5'	14W	.19A
SP-290	290	270	205	50	-	6.5'	17W	.24A
SP-400	400	360	285	155	30	8.5'	30W	.45A
SP-530	530	500	420	305	135	9'	50W	.68A
SP-800	725	690	615	515	420	12'	70W	.50A

GREAT FOR FOUNTAINS AND STATUARY

ALSO AVAILABLE
3 TIER FLOOR DISPLAY
ITEM# 22780
OR
COUNTER TOP DISPLAY
ITEM# 22770



PONDMASTER HY-DRIVE WATER PUMPS



PONDMASTER HY-DRIVE WATER PUMPS are rugged, powerful and energy-efficient, ideal for use in larger ponds, skimmers and waterfalls. All pumps come with a full set of fittings and include a free pump bag for extra pump protection.

FEATURES

- Powerful, Efficient Hybrid Magnetic/Direct Drive Motor
- Energy-Efficient and Whisper-Quiet Operation
- High-Efficiency Vortex Impeller
- Convenient Carry Handle
- Includes Extra Large Clog Resistant Filter Screen
- Oil-Free / Fish Safe
- Continuous Duty Operation
- 20' Power Cord with Grounded Plug
- In-line and Submersible Operation
- Packed 2 Per Master Carton
- 3 Year Limited Warranty



Swivel Joint Connector



1 1/2" and 2" Barbed Fitting

FREE PUMP BAG FOR EXTRA PUMP PROTECTION



IDEAL FOR USE IN POND SKIMMERS OR ANYWHERE SPACE IS TIGHT

1900 GPH • ITEM# 20210

Max. Watts/Amps	93/1.78
Shutoff	10'
Dimensions (L x W x H)	9.0" x 4.25" x 6.75"
Included Fittings:	(2) 1 1/2" Couplings, (2) 1 1/2" Stepped Barbs and 1 1/2" Swivel Joint Connector

6100 GPH • ITEM# 20225

Max. Watts/Amps	520/4.39
Shutoff	28'
Dimensions (L x W x H)	10.5" x 4.5" x 7.75"
Included Fittings:	1 1/2" Coupling, 2" Coupling, 2" to 1 1/2" Reducer, 1 1/2" Stepped Barb, 2" Stepped Barb, 1 1/2" Swivel Joint Connector

2550 GPH • ITEM# 20215

Max. Watts/Amps	147/1.25
Shutoff	11' 5"
Dimensions (L x W x H)	9.0" x 4.25" x 6.75"
Included Fittings:	(2) 1 1/2" Couplings, (2) 1 1/2" Stepped Barbs and 1 1/2" Swivel Joint Connector

6600 GPH • ITEM# 20230

Max. Watts/Amps	593/4.94
Shutoff	30' 5"
Dimensions (L x W x H)	10.5" x 4.5" x 7.75"
Included Fittings:	1 1/2" Coupling, 2" Coupling, 2" to 1 1/2" Reducer, 1 1/2" Stepped Barb, 2" Stepped Barb, 1 1/2" Swivel Joint Connector

4850 GPH • ITEM# 20220

Max. Watts/Amps	328/2.76
Shutoff	22' 5"
Dimensions (L x W x H)	10.5" x 4.5" x 7.75"
Included Fittings:	1 1/2" Coupling, 2" Coupling, 2" to 1 1/2" Reducer, 1 1/2" Stepped Barb, 2" Stepped Barb, 1 1/2" Swivel Joint Connector

7600 GPH • ITEM# 20235

Max. Watts/Amps	660/5.5
Shutoff	27' 5"
Dimensions (L x W x H)	10.5" x 4.5" x 7.75"
Included Fittings:	1 1/2" Coupling, 2" Coupling, 2" to 1 1/2" Reducer, 1 1/2" Stepped Barb, 2" Stepped Barb, 1 1/2" Swivel Joint Connector

PM NAME	PM ITEM#	Watts	Flow at 1'	Flow at 3'	Flow at 5'	Flow at 7'	Flow at 10'	Flow at 15'	Flow at 20'	Flow at 25'	Flow at 30'	Shut-Off (Feet)
PMHD 1900	20210	93	1710	1325	870	555	-	-	-	-	-	10'
PMHD 2550	20215	147	2380	2010	1490	1045	455	-	-	-	-	11' 5"
PMHD 4850	20220	328	4725	4300	3700	3050	2225	1550	300	-	-	22' 5"
PMHD 6100	20225	520	5750	4725	4175	3450	2400	1625	850	250	-	28'
PMHD 6600	20230	593	6525	6275	5500	4925	4325	3325	2425	1850	550	30' 5"
PMHD 7600	20235	660	7440	7210	6690	6170	5525	3805	2640	1310	-	27' 5"

PONDMASTER CPF SERIES PRESSURIZED FILTERS

THE PONDMASTER COMPACT PRESSURIZED FILTERS ARE IDEAL FOR SMALL TO MEDIUM PONDS AND WATER FEATURES. THEY'VE BEEN DESIGNED TO REDUCE REQUIRED MAINTENANCE WHILE ESTABLISHING A HEALTHY ENVIRONMENT FOR FISH AND AQUATIC PLANTS. THE UV CLARIFIER OPTIONS HELP CLEAR PONDS OF GREEN WATER ALGAE.

FEATURES

- Detachable Hose Assembly Module allows Quick Shutoff and Easy Disconnection of Hoses for Faster, Easier Filter Maintenance.
- Reusable Biological and Mechanical Filtering Material Help Maintain a Healthy Environment for Your Fish and Aquatic Plants
- Biological Media Offers Tremendous Surface Area for Beneficial Bacterial Growth – Never Needs Replacing
- Reusable Foam Filter Pad Provides Mechanical Filtration
- Available UV Clarifier Models Help Reduce Free Floating Algae in Pond Water
- Heavy Duty Weather Resistant ABS Plastic Housing Can Be Buried for Inconspicuous Installation
- Maximum Efficiency and Minimum Power Consumption When Used with Pondmaster Magnetic Drive Pumps
- Ideal for Small to Medium Water Gardens, Barrel/Container Ponds
- Can Also Be Used as a Trickle Filter for Small Waterfalls
- Packed 2 per Master Carton
- 1 Year Limited Warranty

CPF 250 • ITEM# 05410

CPF 250 WITH 13 WATT UV CLARIFIER • ITEM# 05415

Capacity	250 Gallon
Max. Pump Size	500 GPH
*Tubing Size: Inlet	3/4" Inside Diameter
Outlet	3/4" Inside Diameter
Dimensions (L x W x H)	9 1/2" x 10" x 17"

CPF 500 • ITEM# 05420

CPF 500 WITH 13 WATT UV CLARIFIER • ITEM# 05425

Capacity	500 Gallon
Max. Pump Size	950 GPH
*Tubing Size: Inlet	3/4" Inside Diameter
Outlet	3/4" Inside Diameter
Dimensions (L x W x H)	9 1/2" x 10" x 17"

CPF 1000 • ITEM# 05430

CPF 1000 WITH 13 WATT UV CLARIFIER • ITEM# 05435

Capacity	1000 Gallon
Max. Pump Size	1200 GPH
*Tubing Size: Inlet	3/4" Inside Diameter
Outlet	3/4" Inside Diameter
Dimensions (L x W x H)	9 1/2" x 10" x 19 1/2"

*Tubing Sold Separately

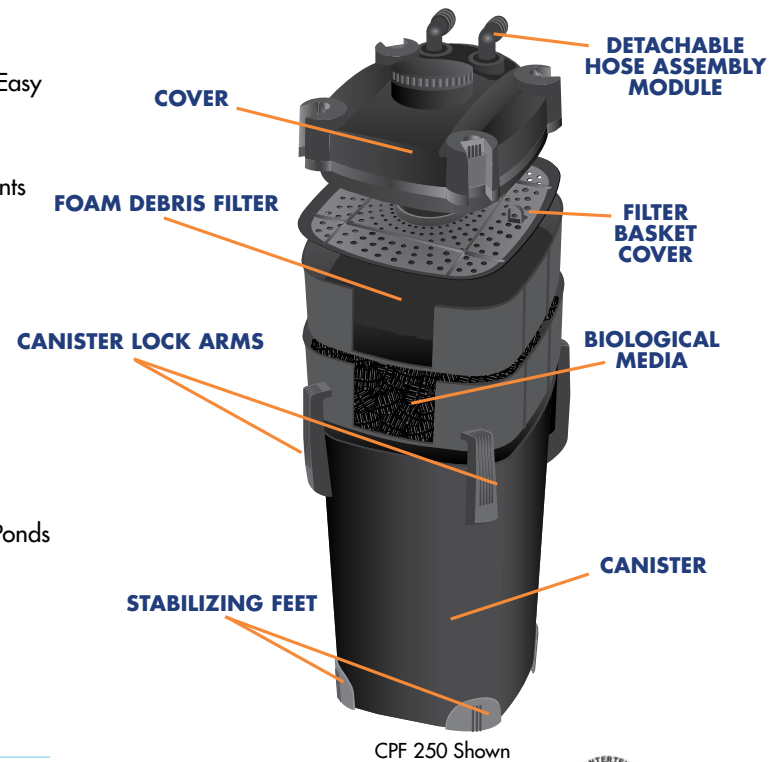

CPF 250 Shown



CPF 500 Shown

CPF SERIES REPLACEMENT MEDIA & PARTS

- Replacement Foam for CPF 250 - Item# 15415
- Replacement Bio-Matrix Ball Media, 40 pcs - Item# 15420
- 13 Watt CPF UV Replacement Lamp - Item# 15455
- CPF UV Quartz Replacement Sleeve - Item# 15460

PONDMASTER CLEARGUARD PRESSURIZED FILTER

PONDMASTER

PONDMASTER CLEARGUARD PRESSURIZED POND FILTER KEEPS YOUR POND FRESH AND CLEAN WITH DUAL-ACTION BIOLOGICAL AND MECHANICAL FILTRATION. CLEARGUARD'S UNIQUE DESIGN FILTERS WITH BENEFICIAL BACTERIA USING BIO-MEDIA WHILE AT THE SAME TIME, MECHANICALLY POLISHING WATER WITH A REUSABLE FILTER PAD. THIS SYSTEM CAN BE ADDED TO ANY POND AND WILL EFFECTIVELY LOWER AMMONIA AND NITRITE LEVELS. WITH THE AVAILABLE UV CLARIFIER INSTALLED, CLEARGUARD CONTROLS GREEN WATER WHILE ITS MULTI-FUNCTION VALVE SELECTOR EASILY CLICKS INTO PLACE FOR CONVENIENT FILTERING, BACK WASHING, RINSING AND WINTERIZING.

FEATURES

- 7 Functions: Filter, Backwash, Rinse, Winterize, Empty, Circulate and Close
- Reusable Foam Pad Removes Fine Debris and Polishes Water Quickly
- Combination of Biological & Mechanical Media for Maximum Water Clarity and Healthier Ponds
- Available With or Without UV Clarifier (Units with UV Clarifier include ETL Transformer)
- Separate UV Clarifiers are offered in 9W, 18W and 36W sizes and can be used for Replacement & Upgrading
- Comes in 2700, 5500, 8000 and 16000 Gallon Sizes
- Includes both PVC Slip Fittings and ABS Barbed Fittings
- Optional Clearguard Backwash Air Kit Available for Ultimate Performance
- 1 Year Limited Warranty



Clearguard Pressurized Filter Shown with a Clearguard Backwash Air Kit Connected, See page 17 for Backwash Air Kit Information.

**7 FUNCTIONS:
FILTER, BACKWASH,
RINSE, WINTERIZE,
EMPTY, CIRCULATE
AND CLOSE**



Clearguard Backwash Air Kits available with or without Air Pump.

PONDMASTER CLEARGUARD PRESSURIZED FILTER

CLEARGUARD PRESSURIZED FILTERS WITHOUT UV CLARIFIER OPTION

CG2700 • ITEM# 05610 • 2700 GALLON CAP

Weight	17.5 lbs.
L x W x H	17" x 17" x 18.5"
Fittings	1½" PVC Slip & ABS Barb
Maximum Pressure	15 PSI
Recommended Water Pumps	Up to 3000 GPH
Recommended Backwash Air Kit	Small with AP-40, Item #15660

CG5500 • ITEM# 05620 • 5500 GALLON CAP

Weight	22 lbs.
L x W x H	17" x 17" x 28.5"
Fittings	1½" & 2" PVC Slip & ABS Barb
Maximum Pressure	15 PSI
Recommended Water Pumps	Up to 6000 GPH
Recommended Backwash Air Kit	Small with AP-40, Item #15660

CG8000 • ITEM# 05630 • 8000 GALLON CAP

Weight	23 lbs.
L x W x H	17" x 17" x 35"
Fittings	1½" & 2" PVC Slip & ABS Barb
Maximum Pressure	15 PSI
Recommended Water Pumps	Up to 8000 GPH
Recommended Backwash Air Kit	Large with AP-60, Item #15670

CG16000 • ITEM# 05640 • 16000 GALLON CAP

Weight	84 lbs.
L x W x H	23" x 23" x 40"
Fittings	3" PVC Slip & ABS Barb
Maximum Pressure	20 PSI
Recommended Water Pumps	Up to 9000 GPH
Recommended Backwash Air Kit	Large with AP-60, Item #15670

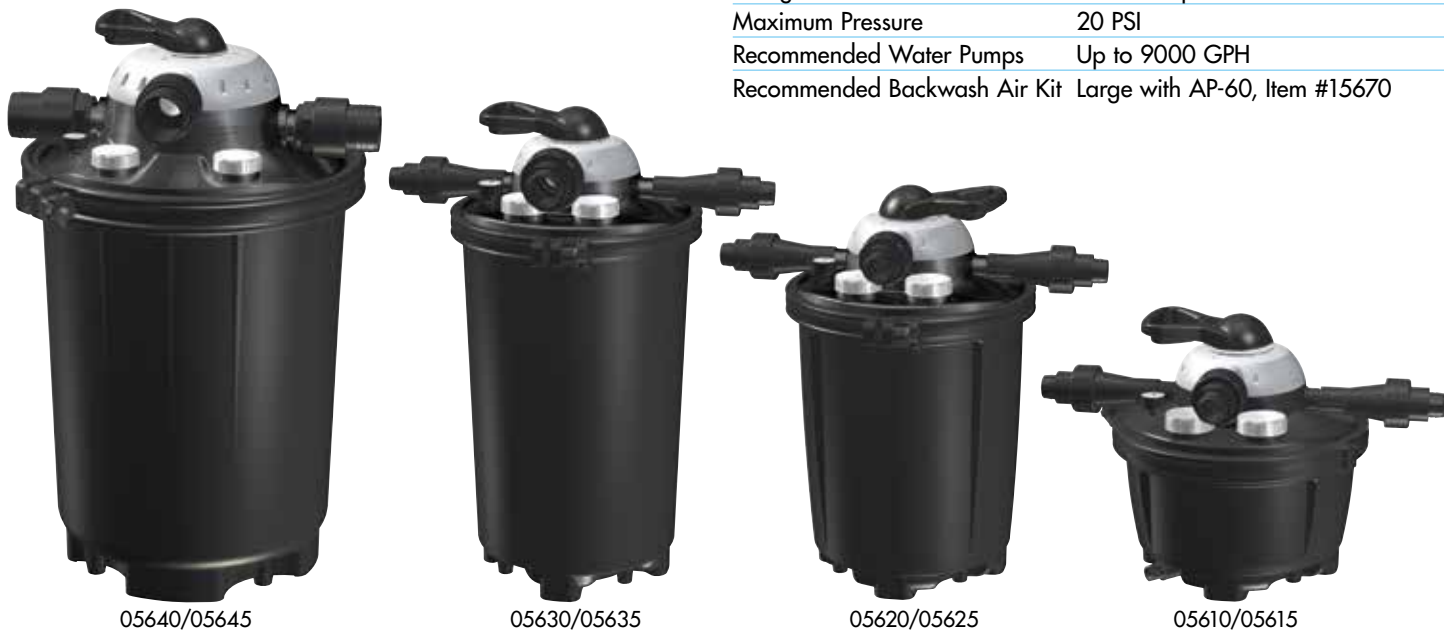

05640/05645

05630/05635

05620/05625

05610/05615

CLEARGUARD PRESSURIZED FILTERS WITH UV CLARIFIER

CGUV2700 • ITEM# 05615 • 2700 GALLON CAP

UV Wattage	9W
Weight	18.5 lbs.
L x W x H	17" x 17" x 18.5"
Fittings	1½" PVC Slip & ABS Barb
Maximum Pressure	15 PSI
Recommended Water Pumps	Up to 3000 GPH
Recommended Backwash Air Kit	Small with AP-40, Item #15660

CGUV-5500 • ITEM# 05625 • 5500 GALLON CAP

UV Wattage	18W
Weight	23 lbs.
L x W x H	17" x 17" x 28.5"
Fittings	1½" & 2" PVC Slip & ABS Barb
Maximum Pressure	15 PSI
Recommended Water Pumps	Up to 6000 GPH
Recommended Backwash Air Kit	Small with AP-40, Item #15660

CGUV8000 • ITEM# 05635 • 8000 GALLON CAP

UV Wattage	36W
Weight	24 lbs.
L x W x H	17" x 17" x 35"
Fittings	1½" & 2" PVC Slip & ABS Barb
Maximum Pressure	15 PSI
Recommended Water Pumps	Up to 8000 GPH
Recommended Backwash Air Kit	Large with AP-60, Item #15670

CGUV16000 • ITEM# 05645 • 16000 GALLON CAP

UV Wattage	36W
Weight	86 lbs.
L x W x H	23" x 23" x 40"
Fittings	3" PVC Slip & ABS Barb
Maximum Pressure	20 PSI
Recommended Water Pumps	Up to 9000 GPH
Recommended Backwash Air Kit	Large with AP-60, Item #15670

INSIDE THE PONDMASTER CLEARGUARD PRESSURIZED FILTER

PONDMASTER

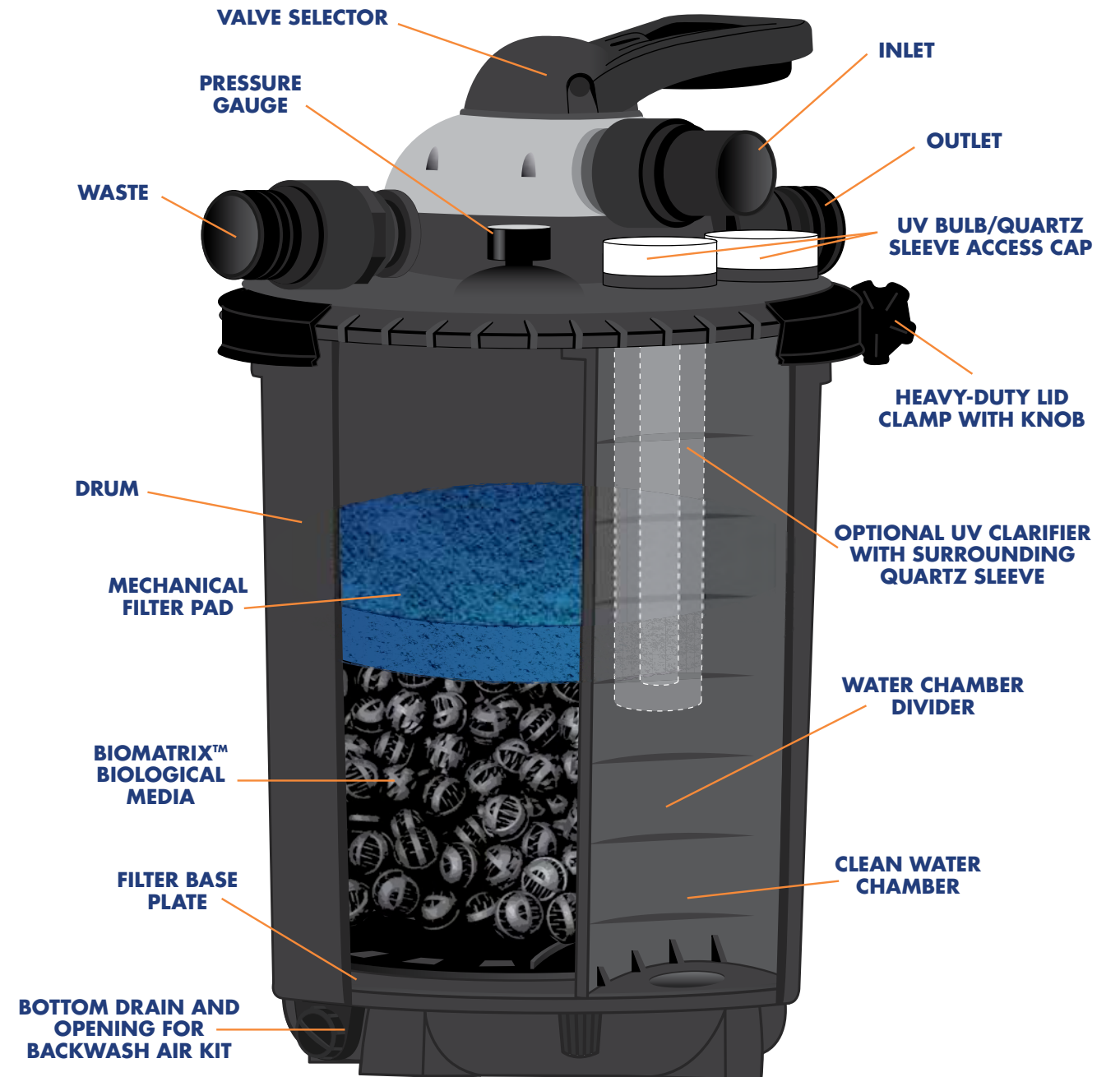

SUBSCRIBE TO OUR YOUTUBE CHANNEL AND VIEW OUR SERIES OF CLEARGUARD PRODUCT VIDEOS!

WWW.YOUTUBE.COM/DANNERMFG

PONDMASTER CLEARGUARD UV CLARIFIER KIT AND CLEARGUARD BACKWASH AIR KIT

PONDMASTER CLEARGUARD UV CLARIFIER KIT adds the benefit of an ultraviolet clarifier to your existing Pondmaster Clearguard Pressurized Pond Filter. UV Clarifiers help control green water and enhance the cleaning action of any Clearguard Pond Filter (maximum of 2 UV Clarifiers can be placed in any Clearguard unit.)

FEATURES

- UV Lamp
- High Quality Quartz Sleeve
- ETL Listed Transformer with 20' Power Cord

9 WATT UV CLARIFIER KIT • ITEM# 15810

For use with Pondmaster Clearguard Models 2700 and 5500

18 WATT UV CLARIFIER KIT • ITEM# 15820

For use with Pondmaster Clearguard 5500, 8000, and 16000 Models



36 WATT UV CLARIFIER KIT • ITEM# 15850

For use with Pondmaster Clearguard 8000, and 16000 Models

THE PONDMASTER CLEARGUARD BACKWASH AIR KIT lets you achieve the ultimate back washing performance for your filter. Simply connect the Air Kit to the bottom of your Clearguard Pressurized Pond Filter and the Backwash Air Kit will quickly loosen pond waste in the filter by agitating the biological media.

KIT INCLUDES

- Pondmaster Air Pump
- Shut Off Valve
- Vinyl Tubing
- Clamps & Appropriate Fittings

SMALL BACKWASH AIR KIT • ITEM# 15660

- Use with the Pondmaster Clearguard Models 2700 and 5500
- Supplied with AP-40 Air Pump

LARGE BACKWASH AIR KIT • ITEM# 15670

- Use with the Pondmaster Clearguard Models 8000 and 16000
- Supplied with AP-60 Air Pump

BACKWASH KIT WITHOUT AIR PUMP • ITEM# 15675

- Use with all Pondmaster Clearguard Models 2700, 5500, 8000 and 16000



Small Backwash Air Kit
Item# 15660 shown



Clearguard Backwash Air Kit with Air Pump shown connected to a Clearguard Pressurized Filter



PONDMASTER CLEARGUARD ACCESSORIES

CLEARGUARD UV SLEEVES

9W REPLACEMENT UV SLEEVE • ITEM# 15812

For use with Clearguard 2700 Filter

Packed 4 Per Master Carton

18W REPLACEMENT UV SLEEVE • ITEM# 15822

For use with CLEARGUARD 5500, 8000 and 16000 Filters

Packed 4 Per Master Carton

36W REPLACEMENT UV SLEEVE • ITEM# 15852

For use with CLEARGUARD 8000 and 16000 Filters

Packed 4 Per Master Carton

CLEARGUARD UV BULBS

9W REPLACEMENT UV BULB • ITEM# 15615

For use with Clearguard 2700 Filter

Packed 4 Per Master Carton

18W REPLACEMENT UV BULB • ITEM# 15628

For use with Clearguard 5500, 8000 and 16000 Filters. Models vary.

Check ballast for wattage rating. UV Bulb wattage must match ballast wattage.

Packed 4 Per Master Carton

36W REPLACEMENT UV BULB • ITEM# 15851

For use with Clearguard 8000 and 16000 Filters. Models vary. Check ballast

for wattage rating. UV Bulb wattage must match ballast wattage.

Packed 4 Per Master Carton

CLEARGUARD BIOMATRIX MEDIA

REPLACEMENT BIOMATRIX MEDIA • ITEM# 15650

For use with all Clearguard Filters

300 Bio-Balls Per Bag; Packed 4 Per Master Carton

CLEARGUARD FOAM FILTER PADS

REPLACEMENT FOAM FILTER PAD • ITEM# 15640

For use with Clearguard 2700, 5500 and 8000 Filters

Packed 4 Per Master Carton

REPLACEMENT FOAM FILTER PAD • ITEM# 15645

For use with Clearguard 16000 Filter

Packed 4 Per Master Carton

CLEARGUARD REPLACEMENT FITTINGS

1.5" INLET FITTING KIT • ITEM# 15710

For use with 2700, 5500 and 8000 Filters

Packed 4 Per Master Carton

2" INLET FITTING KIT • ITEM# 15720

For use with 5500 and 8000 Filters

Packed 4 Per Master Carton

1.5" WASTE-OUTLET FITTING KIT • ITEM# 15715

For use with 2700, 5500 and 8000 Filters

Packed 4 Per Master Carton

2" WASTE-OUTLET FITTING KIT • ITEM# 15725

For use with 5500 and 8000 Filters

Packed 4 Per Master Carton

3" INLET-OUTLET-WASTE FITTING KIT • ITEM# 15730

For use with 16000 Filter

Packed 4 Per Master Carton

PONDMASTER



FOR A COMPLETE LIST OF CLEARGUARD REPLACEMENT PARTS, VISIT WWW.DANNERMFG.COM

PONDMASTER ULTRAVIOLET CLARIFIERS

PONDMASTER ULTRAVIOLET CLARIFIERS are an environmentally-friendly way of safely controlling free-swimming "suspended" algae without the use of any chemicals or water treatments. "Suspended" pond algae causes your pond water to become green and cloudy. Pondmaster Ultraviolet Clarifiers help maintain crystal clear water in your pond by passing it in a spiral motion across the UV Lamp mounted inside the housing, greatly reducing the algae levels in your pond.

CAN BE USED EITHER FULLY SUBMERGED OR OUT OF THE WATER AND FEATURE A GLOWING MONITOR HALO RING THAT SHOWS THE CLARIFIER IS WORKING. The soft blue Halo is visible during the day or at night from any angle, but does not detract from the beauty of your pond. Pondmaster Ultraviolet Clarifiers are designed to handle the clarifying needs of ponds up to 6,000 gallons.

FEATURES

- Vortex Flow Design Exposes Water Longer to Ultraviolet Light
- Fully Submersible
- Includes Transformer and 18' Grounded Power Cord
- Black Color is Unobtrusive Whether Used In or Out of the Water
- Includes 3/4", 1", 1 1/2" Stepped Barbed Fittings



The unique vortex flow design of the Ultraviolet Clarifier increases water contact time with the ultraviolet light, while the slim diameter lamp allows the water to get closer to the intense UV rays.

ONE OF THE SIMPLEST AND SAFEST WAYS TO KEEP YOUR POND WATER CLEAN AND CLEAR IS TO INSTALL A UV CLARIFIER

10 WATT SUBMERSIBLE ULTRAVIOLET CLARIFIER ITEM# 02910

Suitable for small Ponds up to 1500 Gallons Using Pumps up to 700 GPH

- One Glowing Monitor Halo Ring™
- Complete with 9000 Hour, Long Life 10 Watt Lamp and Water Tight Quartz Sleeve
- Packed 2 Per Master Carton
- 1 Year Limited Warranty



20 WATT SUBMERSIBLE ULTRAVIOLET CLARIFIER ITEM# 02920: WITH 1" BARBED INLET/OUTLET ITEM# 02925: WITH 1 1/2" MNPT THREADED INLET/OUTLET

Suitable for medium Ponds up to 3000 Gallons Using Pumps up to 1800 GPH

- Two Glowing Monitor Halo Rings™
- Complete with 9000 Hour, Long Life 20 Watt Lamp and Water Tight Quartz Sleeve
- Inlet/Outlet Size for Item# 02920: 1" Barbed
- Packed 2 Per Master Carton
- 1 Year Limited Warranty



02920

Available with 1 1/2" Male Threaded Outlets



02925

40 WATT SUBMERSIBLE ULTRAVIOLET CLARIFIER ITEM# 02940

Suitable for large Ponds up to 6000 Gallons Using Pumps up to 3000 GPH

- Three Glowing Monitor Halo Rings™
- Complete with 9000 Hour, Long Life 40 Watt Lamp and Water Tight Quartz Sleeve
- Packed 2 Per Master Carton
- 1 Year Limited Warranty



02940

PONDMASTER FILTRATION SYSTEMS

PONDMASTER

THESE INNOVATIVE LOW PROFILE FILTERS are designed to be unobtrusive in the bottom of the pond and its large surface area means less frequent cleaning. More than one filter can be connected to a pump using a tee fitting and offer mechanical, chemical and biological filtration. Dual filter elements offer particle filtering and chemical filtration of certain harmful compounds. **THE FILTER MEDIA IS EASILY RINSED OR CHANGED AND LESS TIME CONSUMING THAN MANY SIMILAR FILTERS OF ITS KIND.**

PM 500 • ITEM# 02205

- For Use with Pumps Up To 500 GPH
- Snap-in Filter Cartridge for Quick Media Replacement
- Quick Disconnect for Easy Removal from Pump
- 9" x 9" Filter Box with Removable Filter Media
- For In-Pond Use Only
- Packed 4 Per Master Carton



02205

PM 1000 • ITEM# 02211

- For Use with Pumps Up To 1000 GPH
- 12" x 12" Filter Box with Locking Handle
- Carbon and Polyester Media for Mechanical/Biological/Chemical Filtration
- Connects to Intake Side of Pump
- Complete with 3/4" I.D. Tubing and Fittings
- Connect More than One to a Pump
- For In-Pond Use Only
- Packed 4 Per Master Carton

GREAT FOR BEGINNERS AND EASY TO CLEAN



02211

PM 2000 • ITEM# 02200

- For Use with Pumps Up To 1800 GPH
- 12" x 24" Filter Box with Carrying Handle
- Polyester and Biological Foam Inserts, Suitable to Hold Other Biological Media
- Connects to Intake Side of Pump
- Complete with 1" I.D. Tubing and Fittings
- Connect More than One to a Pump
- For In-Pond Use Only
- Packed 2 Per Master Carton



02200



PONDMASTER POND KITS

PONDMASTER POND KITS ARE A GREAT AND PRACTICAL WAY TO START THE EXCITEMENT OF WATER GARDENING. THESE KITS ARE DESIGNED TO EASILY MATCH PUMPS WITH FILTERS, INCLUDING FOUNTAIN HEADS WITH TUBING AND FITTINGS WHERE NECESSARY.

PMK 1250 • ITEM# 02212

Suitable for small to medium Ponds up to 600 Gallons

- 250 GPH Pump (CUL/UL Listed)
- Deluxe Filter System (PM1000)
- Bell and Adjustable Fountain Heads
- Tubing and Fittings
- Mechanical, Biological and Chemical Filtration
- Made in USA
- Packed 2 Per Master Carton

PMK 1350 • ITEM# 02213

Suitable for medium Ponds up to 800 Gallons

Same as PMK 1250 but with a 350 GPH Pump (CUL/UL Listed)

PMK 1500 • ITEM# 02215

Suitable for medium Ponds up to 1000 Gallons

Same as PMK 1250 but with a 500 GPH Pump (CUL/UL Listed)

PMK 1700 • ITEM# 02217

Suitable for medium to large Ponds up to 1250 Gallons

Same as PMK 1250 but with a 700 GPH Pump (CUL/UL Listed)

PMK 190 • ITEM# 02019

Suitable for small to medium Ponds and Containers

- 190 GPH Pump (CUL/UL Listed)
- Deluxe Filter System
- Bell Fountain Head
- Mechanical and Biological Filtration
- Packed 4 Per Master Carton

WATERSCAPING DOES NOT NEED TO BE LIMITED TO INGROUND PONDS.

Perfect for the individual who does not desire a full size pond. This kit is specially suited for small areas or for use indoors. Components are sized to work together ensuring customer satisfaction.

190 GPH PUMP AND FOUNTAIN KIT • ITEM# 02273

Suitable for small Barrels and Containers

- 190 GPH Pump (CUL/UL Listed)
- Bell Fountain Head
- Block Foam Filter
- Packed 4 Per Master Carton



GREAT FOR D-I-Y PROJECTS

PONDMASTER AIR PUMPS

PONDMASTER

PONDMASTER AP-SERIES AIR PUMPS have been designed to satisfy the requirements of a multitude of water-related applications. The oil-less motor is designed to operate efficiently and save energy.

FEATURES

- Energy Efficient Motor
- High Volume with Steady Air Flow
- Air Manifold (included)
- Quiet Operation
- No Lubrication Necessary
- Packed 2 Per Master Carton
- Easy to Use
- Single Outlet Discharge
- 1 Year Limited Warranty

GREAT FOR AERATING PONDS

AP-20

	ITEM# 04520
Air Volume	1700 cu.in/min
Maximum Water Depth	7'
Noise Level	40 dba
Watts	20
Weight	5 lbs
Air Manifold Outlets	6
Pressure	4.0 psi
Liters	28 L/min.
Dimensions (L x W x H)	8 1/2" x 5 1/2" x 6"
Cord Length	6'

Note: Can Accept 5/8" I.D. Tubing to Extend Distance between Air Pump and Manifold

AP-40

	ITEM# 04540
Air Volume	2900 cu.in/min
Maximum Water Depth	9.6'
Noise Level	40 dba
Watts	40
Weight	9 lbs
Air Manifold Outlets	12
Pressure	4.85 psi
Liters	47 L/min.
Dimensions (L x W x H)	9 5/8" x 6 5/8" x 7"
Cord Length	6'

Note: Can Accept 3/4" I.D. Tubing to Extend Distance between Air Pump and Manifold

AP-60

	ITEM# 04560
Air Volume	5500 cu.in/min
Maximum Water Depth	10'
Noise Level	45 dba
Watts	60
Weight	14 lbs
Air Manifold Outlets	14
Pressure	5.66 psi
Liters	90 L/min.
Dimensions (L x W x H)	10" x 7 1/2" x 8 1/2"
Cord Length	6'

Note: Can Accept 3/4" I.D. Tubing to Extend Distance between Air Pump and Manifold

AP-100

	ITEM# 04580
Air Volume	9150 cu.in/min
Maximum Water Depth	11.5'
Noise Level	45 dba
Watts	100
Weight	16.5 lbs
Air Manifold Outlets	33
Pressure	6.53 psi
Liters	150 L/min.
Dimensions (L x W x H)	11 3/4" x 8" x 8 7/8"
Cord Length	6'

Note: Can Accept 3/4" I.D. Tubing to Extend Distance between Air Pump and Manifold



As a general rule of thumb, a minimum of 40 L/min (Liters Per Minute) of air is needed for every 1,000 gallons of water in a pond to maintain safe levels of dissolved oxygen.

AP-20 POND AERATION KIT • ITEM# 04511

- Aerates Ponds up to 2,000 Gallons
- Provides Vital Oxygen to Your Fish and Plants
- Easy-to-Install Kit Contains Everything You Need to Aerate Your Pond
- Improves Overall Pond Water Quality

KIT INCLUDES

- (1) AP-20 Air Pump
- (1) 6 Port Manifold
- (6) 4" Air Stones
- (3) 16' Sections of Air Line Tubing



FOR A COMPLETE LIST OF REPLACEMENT DIAPHRAGM KITS AND MANIFOLDS VISIT WWW.DANNERMFG.COM

PONDMASTER PUMPGUARD™

PONDMASTER PUMPGUARD IS AN EASY MAINTENANCE SOLUTION TO KEEP WATER PUMPS RUNNING LIKE NEW. DANNER RECOMMENDS CONSUMERS TO USE PUMPGUARD EVERY SIX MONTHS TO INSURE PROPER OPERATION OF THEIR PUMPS.

FEATURES & BENEFITS

- Instantly Loosens Mineral Scale, Lime, Rust and other Detritus from Pond Water Pumps
- Keeps Your Pump Operating Properly and Efficiently
- Fast and Easy to Use
- Biodegradable

DIP/SOAKING TREATMENT (32 OZ or 1 GAL):

- Pour Pumpguard™ into a plastic container
- Remove all matter from the exterior surface of the pump
- Soak in Pumpguard™
- Let sit for 3-5 minutes
- Rinse with water
- Return pump back to your desired location

IMPELLER TREATMENT (4 OZ.):

- Position the inlet portion of the pump vertically
- Slowly fill the volute (inlet) with Pumpguard™
- Let sit for 3-5 minutes
- Rinse with water
- Return pump back to your desired location

**QUICKLY
CLEANS
CALCIFIED
DIRTY PUMPS
IN MINUTES**



PONDMASTER PUMPGUARD™ 4 OZ. • ITEM# 03905

Packed 12 per Master Carton

PONDMASTER PUMPGUARD™ 32 OZ. • ITEM# 03907

Packed 6 per Master Carton

PONDMASTER PUMPGUARD™ 1 GALLON BOTTLE • ITEM# 03909

Packed 4 per Master Carton

BEFORE PUMPGUARD™



AFTER PUMPGUARD™



PONDMASTER POND-CLEAN AND PONDMASTER KOI FOOD

PONDMASTER

POND-CLEAN READY-TO-USE CLEANER FOR POND EQUIPMENT AND SURFACES.

Pond-Clean is a biodegradable, safe cleaner formulated to rapidly dissolve all types of mineral scale, lime and rust from equipment used in ponds. Safe for use with plastic, ceramic, rubber, PVC, titanium, copper, nickel and short-term use with stainless steel.* Pond-Clean can be used to thoroughly clean an entire Pond after all inhabitants are removed prior to use and any spent cleaner is thoroughly mixed with water. Everything must be rinsed and flushed before returning Inhabitants.

FEATURES & BENEFITS

- Instantly Loosens Mineral Scale, Lime, Rust and other Detritus from Pond Pumps, Equipment and Surfaces
- Effectively Cleans All of the Surfaces of Your Pumps and Pond Equipment
- Fast and Easy to Use
- Biodegradable



PONDMASTER POND-CLEAN 32 OZ. TRIGGER SPRAY • ITEM# 03953

PONDMASTER POND-CLEAN 32 OZ. BOTTLE • ITEM# 03955

PONDMASTER POND-CLEAN 1 GALLON BOTTLE • ITEM# 03957

*Not for use on aluminum, magnesium or Air Stones.

PONDMASTER KOI FOOD

2 LB. PONDMASTER COLOR & GROWTH DIET KOI FOOD • ITEM# 03720

- 40% Protein for Rapid Fish Growth
- Made with Spirulina to Enhance Color
- Perfect for Growing Show Quality Koi

2 LB. PONDMASTER STAPLE DIET KOI & GOLDFISH FOOD • ITEM# 03725

5 LB. PONDMASTER STAPLE DIET KOI & GOLDFISH FOOD • ITEM# 03730

- Balanced Diet for Everyday Feeding
- Softens Fast for Easy Digestion
- Great for All Pond Fish



*Not for use on aluminum, magnesium or Air Stones.

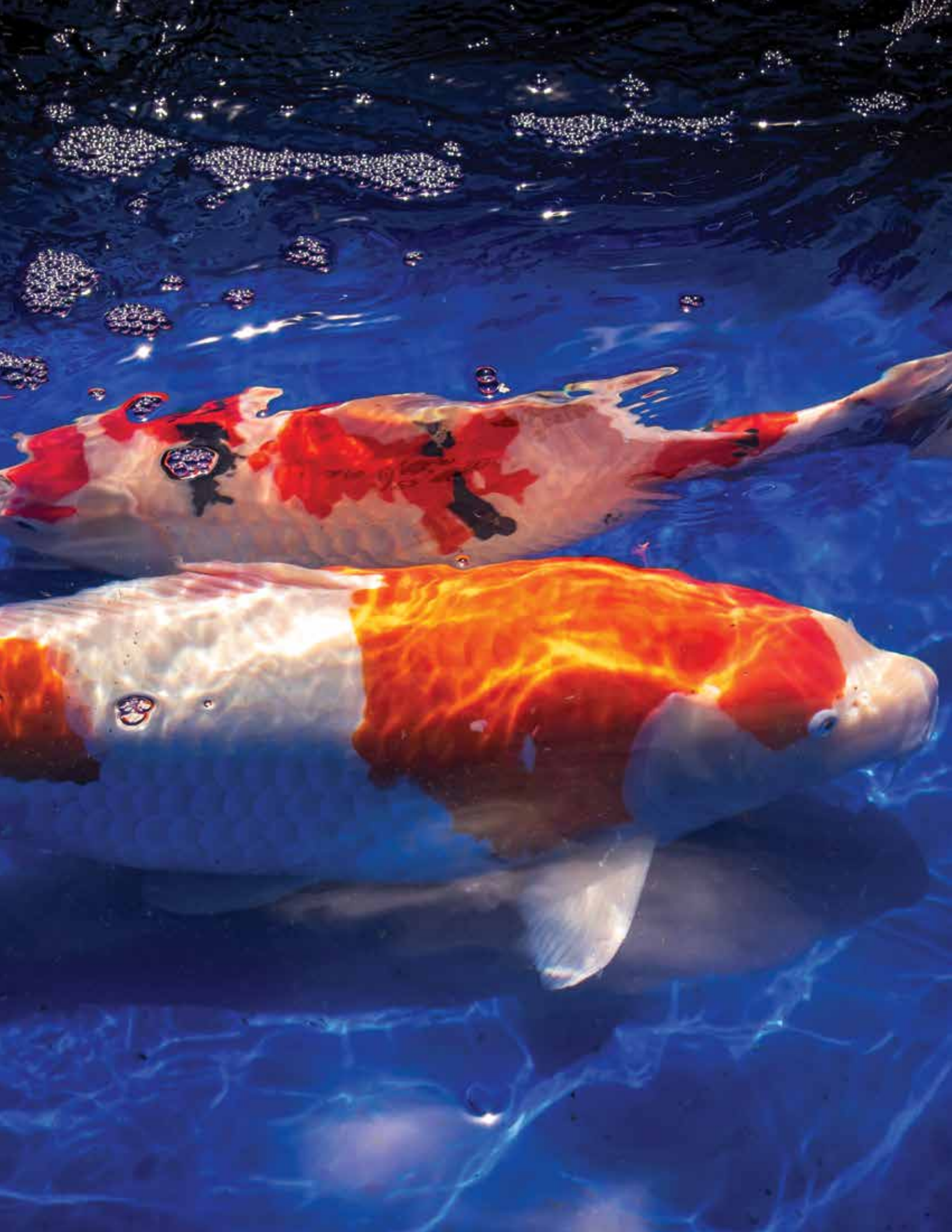

DANNER WATER TREATMENTS

PONDMASTER®

DANNER WATER TREATMENTS CONTAIN TOP-QUALITY, SPECIALLY BLENDED FORMULAS THAT PROMOTE THE HEALTH AND BEAUTY OF ANY POND OR WATER GARDEN. DANNER OFFERS A FULL-RANGE OF TREATMENTS THAT HELP CONSUMERS EASILY CHOOSE THE RIGHT PRODUCT TO OBTAIN PROPER WATER QUALITY.

DANNER SLUDGE REMOVER WITH BARLEY 20 OZ. (VOLUME) DRY POWDER • ITEM# 03972

- Reduced and Simplifies Maintenance
- Promotes a Clean, Clear and Healthy Pond
- Sludge-eliminating Bacteria Rapidly Digest Waste
- Contains Barley
- Safe for Fish, Plants and Wildlife
- Treats 12,500 Gallons

DANNER WATERFALL CLEANER 20 OZ. (VOLUME) DRY POWDER ITEM# 03973

- Fast-Acting
- Prevents & Reduces Odors
- Oxidizes Debris
- Increases Oxygen Levels
- Use to Spot-Treat Waterfalls & Streams
- Improves Filter Functioning
- Non-toxic & Safe for Fish, Birds, Pets & Plants

DANNER WATER CONDITIONER 16 OZ. • ITEM# 03970

- Makes Tap Water Safe for Fish Instantly
- Removes Chlorine, Chloramines and Heavy Metals
- Reduces Stress
- Replenishes Fish Slime Coat and Promotes Healing
- Power of Aloe Vera and Vitamin E
- Promotes Nitrification
- Treats 1,920 Gallons

DANNER SLUDGE REMOVER & CLEANER 16 OZ. • ITEM# 03928

- Reduces and Simplifies Maintenance
- Promotes a Clean, Clear and Healthy Pond
- Sludge-eliminating Bacteria Rapidly Digest Waste
- Naturally Reduces Odors and Clarifies Water
- Treats 1,920 Gallons

DANNER CHLORINE, CHLORAMINE AND AMMONIA REMOVER 16 OZ. ITEM# 03971

- Instantly Removes Toxic Ammonia
- Removes Chlorine and Chloramine from Tap Water
- Safe for Fish, Plants and Wildlife
- Treats 1,920 Gallons
- Non-toxic & Safe for Fish, Birds, Pets & Plants

PONDMASTER POND DYE BLUE 8 OZ. • ITEM# 03715

- Shades Pond from Harmful UV Rays
- Conceals Fish from Predatory Birds
- Concentrated, Easy to Use Formula
- Safe for all Fish, Plants and Wildlife
- Treats 4,000 Gallons

DANNER pH DOWN 16 OZ. ITEM# 03936

- pH Adjuster for Fresh and Saltwater
- Increases Acidity
- Reduces Alkalinity
- Correct pH Improves Biological Filter Efficiency

DANNER pH UP 16 OZ. ITEM# 03938

- Reduces Acidity
- Increases Alkalinity
- Correct pH Improves Biological Filter Efficiency

DANNER CLARIFIX™ WATER CLARIFIER 16 OZ. • ITEM# 03710

- Cleans & Clears Pond Water in as Little as 24 Hours
- Maintains Crystal Clear Pond Water
- Improves Filter Efficiency
- Safe for Fish, Plants and Wildlife
- Treats 4,800 Gallons

PONDMASTER FOUNTAIN CLEAR 8 OZ. • ITEM# 03911

- Specially Formulated to keep Fountain and Statuary Water Clear
- Uses Waste-Digesting Bacteria and Enzymes
- Helps Control Lime and Foam
- Reduces Filter Clogging and Maintenance
- Safe for all Fish, Plants and Wildlife
- Treats 160 Gallons



03710



03928



03973



03972



03970



03971

PONDMASTER DISAPPEARING FOUNTAIN BASIN AND PONDMASTER FOUNTAIN HEAD KITS

PONDMASTER DISAPPEARING FOUNTAIN BASIN • ITEM# 22570

- Includes 2'x2' Basin, Grating, Plastic Mesh Screen and PVC Support Insert (Does not Include Pottery, Pump or Decorative Stone)
- Easy to Install
- Strong and Durable
- Install Basin In-Ground, Semi In-Ground or Above Ground

PONDMASTER FOUNTAIN HEADS

VARIABLE FOUNTAIN HEAD KIT • ITEM# 02077

Suitable for Pondmaster 190 - 700 GPH Pumps

- Add an Exotic Look to any Ordinary Pond
- Easily Adapts to Pumps with 1/4" and 1/2" NPT Male Outlet
- Packed 6 Per Master Carton

BELL FOUNTAIN HEAD KIT • ITEM# 02088

Suitable for Pondmaster 250 - 700 GPH Pumps

- Large Adjustable Bell (Mushroom) Pattern
- Includes Two 7" Extensions and Pump Adapter
- Packed 6 Per Master Carton



Designed to provide a trouble-free, easy-to-install fountain basin for a wide variety of decorative water feature installations.

MINI BELL FOUNTAIN HEAD KIT • ITEM# 02089

Suitable for Pondmaster 80 - 190 GPH Pumps

- Small Adjustable Bell (Mushroom) Pattern
- Includes Two 7" Extensions
- Packed 6 Per Master Carton



PONDMASTER LED LIGHTED SPILLWAY

PONDMASTER

PONDMASTER LED LIGHTED SPILLWAY is a self-contained LED Spillway that is designed specifically for Waterfalls, Inground Pools, Retaining Walls and many other applications where you desire the beauty of running waterfalls. It features a low energy 3-Watt LED Light Bar that has a brilliant blue colored water feature.

PONDMASTER LED LIGHTED SPILLWAY • ITEM# 03755

- Designed for Self-Contained Waterfalls, Hardscapes, Inground Pools, Retaining Walls and Many other Applications
- Brilliant Blue Colored Water Feature
- Includes a 3/4" to 1-1/4" Stepped Barbed Fitting
- Bottom Mount Connection
- Interior Baffling System that Produces a Single, Lighted Water Sheet
- 12" Wide Spillway with Reinforced Opening with 5" Lip Extension
- 12 Volt Transformer is Outdoor Rated and Listed to US and Canadian ETL Standards
- 33' Power Cord
- Low Energy 3-Watt Light Bar
- Recommended Pump Size: 1000 GPH
- 1 Year Limited Warranty
- Packed 4 Per Master Carton

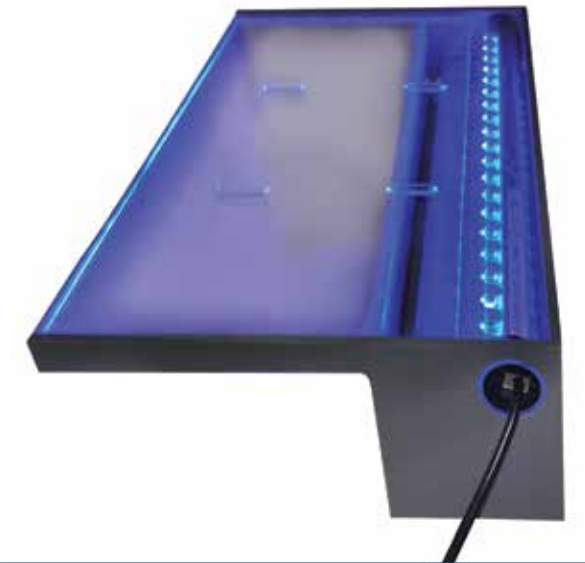

Decorative Hardscapes



Inground Pools

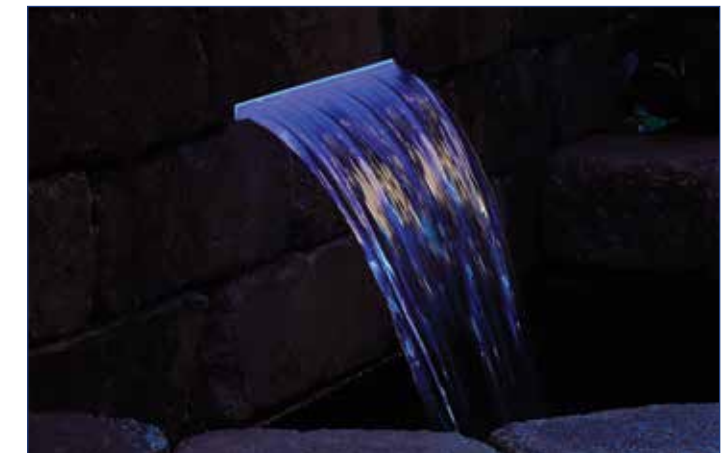

Ponds

PONDMASTER LED LIGHT RING KITS AND PONDMASTER LED LIGHTS

IT'S SHOW TIME WITH THE LED LIGHT RING/FOUNTAINHEAD PUMP ACCESSORY. ATTACH TO YOUR PUMP, WAIT UNTIL DARK AND WATCH AS YOUR WATER GARDEN IS TRANSFORMED WITH THIS SPECTACULAR, BRIGHTLY LIT FLEUR-DE-LIS DISPLAY.

FEATURES

- Adapts to Pumps with 1/2" or 3/4" Threaded Outlets
- Included Diverter Allows for a Second Feature and Controls Fountain Spray Height
- Creates a Dramatic Nighttime Water Feature
- Watertight, Safe Low Voltage Operation
- Energy Saving 18 LED Light Ring
- UL Listed 12 Volt Transformer with 24' Power Cord
- Packed 4 Per Master Carton
- 1 Year Limited Warranty

18 LED LIGHT RING WITH FOUNTAINHEAD • ITEM# 02180

For use with 250 GPH to 950 GPH Pumps

- Adapts to Pumps with 1/2" or 3/4" Threaded Outlets
- Included Diverter Allows for a Second Feature and Controls Fountain Spray Height



1 LED POND LIGHT WITH PHOTOSENSOR AND TRANSFORMER • ITEM# 02387

3 LED POND LIGHT(S) WITH PHOTOSENSOR AND TRANSFORMER • ITEM# 02389

- Illuminate Ponds, Paths, Walkways or Outdoor Statuary
- UV Protective and Impact-Resistant Polycarbonate Lenses
- High Brilliance 2.0 W LED
- Interchangeable Colored Discs
- Adjustable-Angle Light on Weighted Base
- Low Voltage Operation
- Waterproof Seals on Lamp Housing for Safe-Underwater Operation
- 20' Power Cord
- 12 Volt Transformer is Listed to US and Canadian ETL Standards
- Photosensor Automatically Turns Lights On and Off at Dusk & Dawn
- 1 Year Limited Warranty



24 LED LIGHT RING WITH FOUNTAINHEAD • ITEM# 02185

For use with 950 GPH to 1800 GPH Pumps

- Adapts to Pumps with 3/4" or 1" Threaded Outlets
- Included Diverter Allows for a Second Feature & Controls Fountain Spray Height



REPLACEMENT 2.0 W LED BOARD • ITEM# 12330

For use with Pondmaster 1 and 3 LED Pond Lights, Item# 02387 and Item# 02389

- Easy to Install
- Packed 4 Per Master Carton



REPLACEMENT TRANSFORMER • ITEM# 12389

For use with Pondmaster 3 LED Pond Lights, Item# 02389

- Easy to Install

PONDMASTER SPOUTING POND STATUES

PONDMASTER

FEATURES

- Creates a Beautiful and Lively Water Action for Ponds and Water Features
- Handcrafted in Cast Resin
- Aerates Water for a Healthier Pond
- High-Quality Brass Barbed Fitting

- Accents Your Pond and Natural Landscape
- Easy Hook up to a Submersible Pump
- Accepts 1/2" Flexible Tubing (sold separately)

SPOUTING BIRD POND STATUE • ITEM# 03776

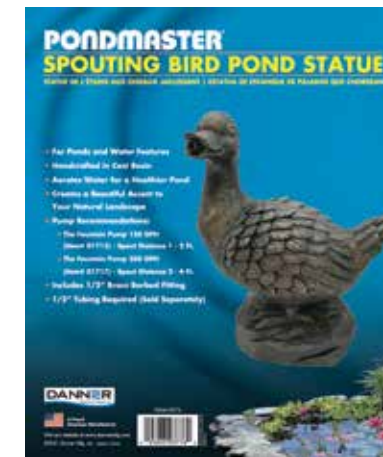

ADD BEAUTY TO YOUR POND WHILE AERATING

SPOUTING FISH POND STATUE • ITEM# 03770

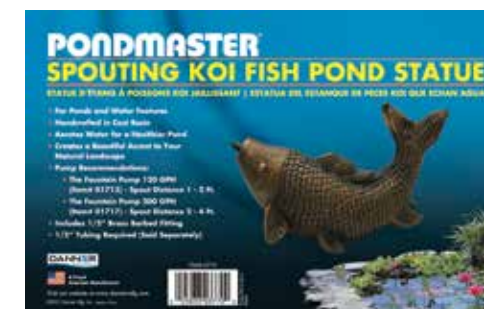

SPOUTING TURTLE POND STATUE • ITEM# 03775



PONDMASTER DE-ICER, FLOATING POND THERMOMETER, AIR DIFFUSERS AND AQUATIC PLANT BASKET

POND DE-ICER • ITEM# 02175

The Floating Winter Pond De-Icer is for use in those colder locations where winter temperatures result in significant or long-term icing of Pond surfaces.

- Energy Efficient with 120 Watts of Heating Power
- For Use in Ponds Up To 250 Gallons
- Fixed Thermostatic Control Reduces Heating Time & Saves Electricity
- Internal Electronics Epoxy Sealed for Watertight Protection
- Made from Rugged, High Impact ABS Plastic
- 18' Power Cord
- Will Not Harm Flexible Liners or Pre-Formed Ponds
- Packed 4 Per Master Carton
- 1 Year Limited Warranty



KEEPS YOUR POND SURFACE OPEN DURING WINTER



FLOATING POND THERMOMETER • ITEM# 02399

For use in all Outdoor Pond and Water Gardens

- Monitor the Temperature in Your Water Feature
- Easily Read – Calibrated in Both °F and °C
- Included Tether Helps Retrieve Unit
- Packed 6 Per Master Carton



6" STRAIGHT AIR DIFFUSER • ITEM# 14570

- For Use with Pondmaster AP-20 and AP-40 Air Pumps
- 16 sq. in. of Active Surface Area.
- Recommended Tubing Sizes: 1/2" or 5/8"
- Packed 6 Per Master Carton



7" DIAMETER RING AIR DIFFUSER • ITEM# 14580

- For Use with Pondmaster AP-40, AP-60 and AP-100 Air Pumps
- 18" Total Length / 48 sq. in. of active surface area
- Recommended Tubing Sizes: 3/4" or 1"
- Packed 6 Per Master Carton



AIR DIFFUSER KIT • ITEM# 14575

- Includes 6" Straight Diffuser and 20 Feet of 5/8" Tubing to fit Pondmaster AP-20 and AP-40 Air Pumps.
- Packed Individually



AQUATIC PLANT BASKET • ITEM# 03760

- 10" x 10" x 5.25" (Deep)
- Ideal for Small to Medium Size Aquatic Plants
- Simply Plant and Lower into Pond
- Allows Water to Reach Roots
- Holds Plant and Soil Securely in Place
- Durable and Long Lasting



PONDMASTER SUPER-FLEX POND LINERS

PONDMASTER®

PONDMASTER® SUPER-FLEX is a flexible polyethylene-based pond liner that combines the strength of Polyethylene liners with the highest flexibility available. This fish-safe liner is ideal for koi ponds, aquatic habitats, water gardens, waterfalls, fountains and streams. Super-Flex is insect-resistant, making it perfect for residential and commercial applications. Super-Flex is half the weight of traditional EPDM liners. All sizes are pre-cut for the consumer and boxed for easy merchandising.

FEATURES

- Flexible, Long-lasting Liner
- Rugged and Lightweight Aqua-Flex Technology
- Tear/Puncture Resistant
- Heat Sealable and has more Flexibility than Traditional Heavy Rubber Liners
- Insect-Resistant
- Safe for Fish and Plants
- 20 Year Limited Warranty
- All Sizes are Packed 1 per Master



2X THE PUNCTURE RESISTANCE OF EPDM AND ONLY 1/2 THE WEIGHT

ITEM#	DESCRIPTION	SIZE	MATERIAL	THICKNESS
02122	GARDEN POND LINER	8' x 12'	PVC	20 mil
02113	BARREL AND FOUNTAIN LINER	6.5' x 5'	LLPDE	30 mil
02114	GARDEN POND LINER	8' x 8'	LLPDE	30 mil
02116	GARDEN POND LINER	12.5' x 15'	LLPDE	20 mil
02117	STREAM LINER	4' x 12'	LLPDE	30 mil

NOTE: BULK/ROLL SIZES ARE AVAILABLE, ASK YOUR DANNER REPRESENTATIVE FOR DETAILS.



PONDMASTER POND NETTING AND POND NETS

POND NETTING

CATCHES FALLING LEAVES AND PROTECTS FISH FROM PREDATORS.

ITEM# 02307 7' x 10' - Packed 18 Per Master Carton

ITEM# 02314 14' x 14' - Packed 12 Per Master Carton

ITEM# 02328 28' x 28' - Packed 6 Per Master Carton



PONDMASTER NETS

PONDMASTER POND NETS FIT ALL YOUR WATER GARDENING NEEDS, LARGE AND SMALL!

They're available in convenient, small stationary sizes or in larger telescoping sizes that reach up to 6 1/2'. Pondmaster Pond Nets are very versatile and can be used for general purposes, surface skimming and Koi handling.

FEATURES

- Heavy Duty Aluminum Construction
- Fish-Safe Soft Nylon Netting
- Sure-Grip Handle
- Telescoping Handles Extend up to 6 1/2'
- Convenient String Loop at End of Handle
- Heavily Padded Rims protect Fish and Nets from Damage
- Packed 6 Per Master Carton

HEAVILY PADDED RIMS PROTECT FISH AND NETS FROM DAMAGE



COMPACT SKIMMER NET • ITEM# 02144

COMPACT ALL PURPOSE NET • ITEM# 02145

COMPACT KOI NET • ITEM# 02146

TELESCOPING LARGE SKIMMER NET • ITEM# 02134

TELESCOPING LARGE ALL PURPOSE NET • ITEM# 02135

TELESCOPING LARGE KOI NET • ITEM# 02136

COMPACT NET DISPLAY • ITEM# 25023

Includes 6 each of Compact Skimmer Net, Compact All Purpose Net and Compact Koi Net

TELESCOPING NET DISPLAY • ITEM# 25021

Includes 6 each of Telescoping Skimmer Net, Telescoping All Purpose Net and Telescoping Koi Net

PONDMASTER®

TUBING, PUMP BAGS AND BARB FITTINGS

FLEXIBLE BLACK VINYL TUBING

Thick walled tubing is kink resistant.

ITEM# 12012 1/2" I.D. x 10' Roll, Packed 6 Per Master

ITEM# 12014 1/2" I.D. x 20' Roll, Individually Packed

ITEM# 12138 3/8" I.D. x 20' Roll, Packed 6 Per Master

ITEM# 12035 3/4" I.D. x 50' Roll, Individually Packed

ITEM# 12039 3/8" I.D. x 100' Roll, Individually Packed

ITEM# 12013 1/2" I.D. x 100' Roll, Individually Packed

ITEM# 12158 5/8" I.D. x 20' Roll, Packed 6 Per Master

ITEM# 12034 3/4" I.D. x 100' Roll, Individually Packed

ITEM# 12050 1" I.D. x 50' Roll, Individually Packed

CORRUGATED BLACK TUBING

Tubing is reinforced on the outside to resist kinks; Smooth on the inside to increase flow. All designed to accommodate Barbed Fittings.

ITEM# 12404 3/4" I.D. x 20' Roll, Individually Packed

ITEM# 12409 1" I.D. x 20' Roll, Individually Packed

ITEM# 12414 1 1/2" I.D. x 20' Roll, Individually Packed

ITEM# 12435 1 1/2" I.D. x 25' Roll, Individually Packed

ITEM# 12412 1 1/2" I.D. x 50' Roll, Individually Packed

ITEM# 12420 2" I.D. x 50' Roll, Individually Packed

ITEM# 12402 1/2" I.D. x 100' Roll, Individually Packed

ITEM# 12403 3/4" I.D. x 100' Roll, Individually Packed

ITEM# 12410 1" I.D. x 100' Roll, Individually Packed

ITEM# 12411 1 1/4" I.D. x 100' Roll, Individually Packed

REINFORCED FLEXIBLE PVC TUBING

Requires less Fitting compared to rigid pipe. Flexible for easy handling and installation. Can be used with PVC Solvent Cements.

ITEM# 12440 2" Fitting Size x 25' Roll, Individually Packed

ITEM# 12436 1 1/2" Fitting Size x 50' Roll, Individually Packed

ITEM# 12441 2" Fitting Size x 50' Roll, Individually Packed

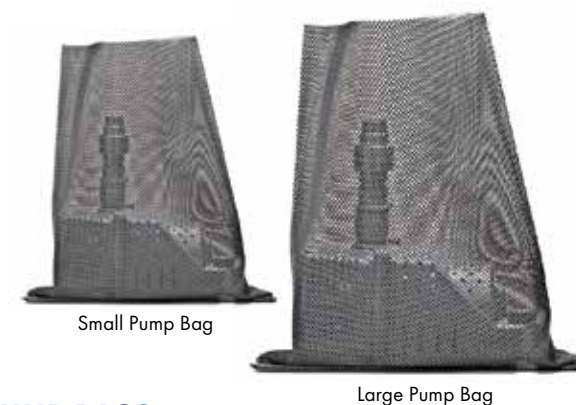

PUMP BAGS

SMALL PUMP BAG (18" X 24") • ITEM# 12315

Packed 6 Per Master

SMALL PUMP BAG BULK (18" X 24") • ITEM# 33010

Packed 20 Per Master

LARGE PUMP BAG (24" X 36") • ITEM# 12320

Packed 6 Per Master

LARGE PUMP BAG BULK (24" X 36") • ITEM# 33020

Packed 20 Per Master

UNIVERSAL BARBS

1 1/2" MPT X 1 1/2" UNIVERSAL BARB • ITEM# 12937

Unique Double Stepped Barb Accommodates All 1 1/2" Tubing

2" MPT X 2" UNIVERSAL BARB • ITEM# 12939

Unique Double Stepped Barb Accommodates All 2" Tubing



PONDMASTER REPLACEMENT FILTER MEDIA

PONDMASTER HAS AN EXTENSIVE LINE OF REPLACEMENT MEDIA CAREFULLY DESIGNED TO MAINTAIN THE EFFECTIVENESS OF THE ORIGINAL FILTER. COARSE POLYESTER AND FOAM FILTERS OFFER BIOLOGICAL FILTRATION; CARBON IMPREGNATED MEDIA OFFERS CHEMICAL AND BIOLOGICAL FILTRATION; ALL OFFER MECHANICAL FILTRATION.

REPLACEMENT PADS • ITEM# 12195

For PMK 190

Foam/Coarse Poly Combo Pak, Packed 6 Per Master

REPLACEMENT PADS • ITEM# 12201

For PM 1000, PM 2000 †

Poly 3 Pak, Packed 6 Per Master

REPLACEMENT PADS • ITEM# 12202

For PM 1000, PM 2000*

Carbon and Coarse Filter Media, Foam Large Double Pack, Packed 6 Per Master

REPLACEMENT PADS • ITEM# 12203

For PM 1000, PM 2000*

Carbon Single Pak, Packed 6 Per Master

REPLACEMENT PADS • ITEM# 12204

For PM 1000, PM 2000*

Coarse Poly Single Pak, Packed 6 Per Master

REPLACEMENT PADS • ITEM# 12205

For PM 1000, PM 2000*

Foam 2 Pak, Packed 6 Per Master

EXTRA LARGE PRE-FILTER • ITEM# 12285

For All Mid-Range Pumps, 250 GPH thru 700 GPH**

Foam Large Single Pak, Packed 6 Per Master

FOAM BLOCKS • ITEM# 12305

For PM 2000

Foam 4 Pak, Packed 6 Per Master

REPLACEMENT PRE-FILTER • ITEM# 12505

For All Mid-Range Pumps, 250 GPH thru 700 GPH

Sleeve Small Single Pak, Packed 6 Per Master

FOAM BLOCK • ITEM# 12600

For Promotional Kits 02272, 02273, 02160

Pre-Filter Single Pak, Packed 6 Per Master

RIGID PRE-FILTER • ITEM# 12960

For ProLine Skimmer Pumps 1400, 2550, 5100, 6100 and Pumps with 1½" MPT Inlet

RIGID PRE-FILTER • ITEM# 12965

Designed as a Pre-Filter for Pumps with 2" MPT Inlet

PRE-FILTER • ITEM# 12605

Pre-Filter for MD 1, MD 1.5, MD 1.9

Pre-Filter 3 Pak, Packed 6 Per Master

FOAM PRE-FILTER • ITEM# 12730

For 950 GPH, 1200 GPH, and 1800 GPH Pumps

Foam Single Pak, Packed 6 Per Master

RIGID PRE-FILTER • ITEM# 12784

Fits 250-700 GPH Pumps

Packed 6 Per Master

RIGID PRE-FILTER • ITEM# 12785

Fits 250-3600 GPH Pumps

BIO-MATRIX MEDIA • ITEM# 12200 (NOT SHOWN)

For All ProLine Pressurized Filters (Not For Use in Clearguard Filters)

8 lbs. Bulk Media

BIO-MATRIX MEDIA • ITEM# 12455

Fits Small & Medium Filter Falls

2 lb. Mesh Bag, Packed 4 Per Master



† Low cost one time use

* This filter media is also a replacement for Pondmaster Kits 02212, 02213, 02215, and 02217

** This filter media is also a replacement for Aquabelle Kits 02282 and 02285

PONDMASTER REPLACEMENT MEDIA AND IMPELLER ASSEMBLIES

PONDMASTER®

PM 500 REPLACEMENT MEDIA

REPLACEMENT CARBON AND COARSE MEDIA • ITEM# 12207

Complete Replacement of Original Media

REPLACEMENT COARSE POLYESTER MEDIA • ITEM# 12208

2 Pack, Coarse Media Traps Larger Debris

REPLACEMENT FOAM FILTER • ITEM# 12209

2 Pack, More Reusable Media

REPLACEMENT FINE POLYESTER MEDIA • ITEM# 12210

2 Pack, Finer Filtering of Debris

COMPLETE REPLACEMENT CARTRIDGE • ITEM# 12211

Complete Cartridge with Original Media Included

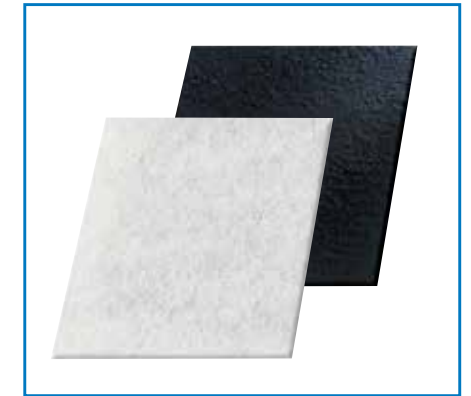

REPLACEMENT IMPELLER ASSEMBLIES

Packed 6 Per Master Carton and individually blister packed or boxed

ITEM# 12650

For 65 GPH Fountain-Mag Pump, ITEM# 02510

ITEM# 11655

For 80 GPH Fountain-Mag Pump, ITEM# 02520

ITEM# 12655

For 140 GPH Fountain-Mag Pump, ITEM# 02521

ITEM# 12955

For 190 GPH Fountain-Mag Pump, ITEM# 02519

ITEM# 12555

For Model 2 Pumps, ITEM# 02512 and ITEM# 02522

ITEM# 12575

For Model 3 and 5 Pumps, ITEM# 02513, ITEM# 02523, ITEM# 02515, ITEM# 02525

ITEM# 12585

For Model 7 Pumps, ITEM# 02517 and ITEM# 02527

ITEM# 12746

For Model 9.5B Pumps, ITEM# 02710 and ITEM# 02720

ITEM# 12756

For Model 12B Pumps, ITEM# 02712 and ITEM# 02722

ITEM# 12776

For Model 18B Pumps, ITEM# 02718 and ITEM# 02728

ITEM# 12791

For Model 24 Pumps Type 'B', ITEM# 02740 and ITEM# 02750

ITEM# 12796

For Model 36 Pumps Type 'B', ITEM# 02745 and ITEM# 02755

ITEM# 16505

Venturi Assembly with Tubing and Muffler

For Pump Models 2, 3, 5, 7

ITEM# 16555

Fractionating Impeller Assembly

For Pump Model 2

ITEM# 16575

Fractionating Impeller Assembly

For Pump Models 3 and 5

ITEM# 16585

Fractionating Impeller Assembly

For Pump Model 7

ITEM# 16705

Venturi Assembly with Tubing and Muffler

For Pump Models 9.5, 12 and 18

ITEM# 16745

Fractionating Impeller Assembly

For Pump Model 9.5B

ITEM# 16755

Fractionating Impeller Assembly

For Pump Model 12B

ITEM# 16775

Fractionating Impeller Assembly

For Pump Model 18B

ITEM# 12792

For Hydro-Air™, ITEM# 02795

FOR A COMPLETE LIST OF REPLACEMENT IMPELLER ASSEMBLIES, VISIT WWW.DANNERMFG.COM



PONDMASTER® ECO



PONDMASTER ECO WATER PUMPS

PONDMASTER ECO WATER PUMPS HAVE A BUILT-IN VARIABLE FLOW CONTROL AND ARE SPECIFICALLY DESIGNED FOR SMALL-TO-MEDIUM SIZE PONDS, STATUARY AND AQUARIUM APPLICATIONS. BUILT TO RUN STEADY AND QUIET, THEY WILL NEVER INTRUDE ON THE TRANQUILITY OF ANY WATER FEATURE OR HOME AQUARIUM.

FEATURES

- Energy-Efficient Magnetic Drive
- Variable Flow Control
- Debris-Reducing Pre-Filter
- All Fittings Included
- 6' Power Cord
- 2 Year Limited Warranty

PONDMASTER ECO 55 GPH PUMP ITEM# 80410

Max. Flow Rate	55 GPH
Max. Pumping Height	2'
Watts	5.75
Power	115V, 60Hz
Intake	Screened*
Discharge	1/4" and 3/8" Stepped Slip Fitting
Cord Length	6'

*For Submersible Use Only.

PONDMASTER ECO 75 GPH PUMP ITEM# 80415

Max. Flow Rate	75 GPH
Max. Pumping Height	2.5'
Watts	5.75
Power	115V, 60Hz
Intake	Screened*
Discharge	1/2" and 3/8" Male Slip Fitting
Cord Length	6'

*For Submersible Use Only.



**RUGGED,
ECONOMICAL
AND PROVED
WATER
PUMPS**

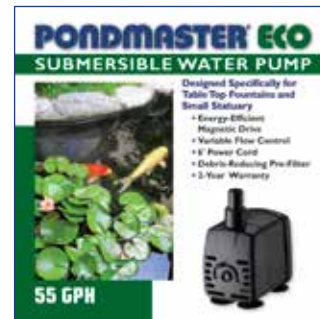

PONDMASTER ECO WATER PUMPS

PONDMASTER ECO

FEATURES

- Energy-Efficient Magnetic Drive
- Variable Flow Control
- Debris-Reducing Pre-Filter
- All Fittings Included
- 15' Power Cord
- 2 Year Limited Warranty

PONDMASTER ECO 150 GPH PUMP ITEM# 80425

Max. Flow Rate	160 GPH
Max. Pumping Height	5.5'
Watts	13
Power	115V, 60Hz
Intake	Screened*
Discharge	1/2" and 3/8" Stepped Slip Fitting
Cord Length	6' with Ground Plug

*For Submersible Use Only.

PONDMASTER ECO 290 GPH PUMP ITEM# 80435

Max. Flow Rate	290 GPH
Max. Pumping Height	6.5'
Watts	17
Power	115V, 60Hz
Intake	Screened*
Discharge	1/2" and 3/4" Threaded Barbed Fittings
Cord Length	15' with Ground Plug

*Includes 1/2" Threaded Intake for In-Line use w/ screen removed.

PONDMASTER ECO 1000 GPH PUMP ITEM# 80450

Max. Flow Rate	1000 GPH
Max. Pumping Height	9'
Watts	70
Power	115V, 60Hz
Intake	Screened*
Discharge	3/4" and 1" Threaded Barbed Fittings
Cord Length	15' with Ground Plug

*Includes 1" Threaded Intake for In-Line use w/ screen removed.

PONDMASTER ECO 2175 GPH PUMP ITEM# 80465

Max. Flow Rate	2175 GPH
Max. Pumping Height	16.5'
Watts	125
Power	115V, 60Hz
Intake	Screened*
Discharge	1" Threaded Barbed Fittings
Cord Length	15' with Ground Plug

*Includes 1" Threaded Barbed Fitting for In-line use.

PONDMASTER ECO 175 GPH PUMP ITEM# 80430

Max. Flow Rate	175 GPH
Max. Pumping Height	4'
Watts	10.5
Power	115V, 60Hz
Intake	Screened*
Discharge	1/2" and 3/8" Threaded Barbed Fitting
Cord Length	15' with Ground Plug

*Includes 3/4" Threaded Intake for In-Line use w/ screen removed.

PONDMASTER ECO 590 GPH PUMP ITEM# 80445

Max. Flow Rate	590 GPH
Max. Pumping Height	7.5'
Watts	40
Power	115V, 60Hz
Intake	Screened*
Discharge	1/2" and 3/4" Threaded Barbed Fittings
Cord Length	15' with Ground Plug

*Includes 3/4" Threaded Barbed Fitting for In-line use.

PONDMASTER ECO 1350 GPH PUMP ITEM# 80455

Max. Flow Rate	1350 GPH
Max. Pumping Height	13.5'
Watts	125
Power	115V, 60Hz
Intake	Screened*
Discharge	3/4" and 1" Threaded Barbed Fittings
Cord Length	15' with Ground Plug

*Includes 1" Threaded Barbed Fitting for In-line use.





PONDMASTER ECO FOUNTAINHEAD & PUMP KITS

PONDMASTER ECO

FOUNTAINHEAD PUMP KITS ADD A NEW DIMENSION TO ANY WATER FEATURE. We've paired our most popular size pumps with variable flow control fountainheads to give homeowners an opportunity to create an entirely different mood in their pond. These reliable kits will work well with any small-to-medium size installation.

FEATURES

- Energy-Efficient Magnetic Drive Pump
- Fountainhead Variable Flow Control
- Intake Pre-Filter
- 15' Power Cord with Grounded Plug
- 2 Year Limited Warranty

CREATE YOUR OWN TRANQUIL OASIS



Bell Shape



Fleur de Lis



Double Fleur de Lis

PONDMASTER ECO 225 GPH KIT ITEM# 82415

Maximum Flow	225 GPH
Maximum Pumping Height	6.0'
Watts	19
Power	115V, 60Hz
Barbed Adaptors Included	1/2" and 3/4"
Fountainheads Included:	Bell Shape & Fleur de Lis



PONDMASTER ECO 400 GPH KIT ITEM# 82425

Maximum Flow	400 GPH
Maximum Pumping Height	6.5'
Watts	20
Power	115V, 60Hz
Barbed Adaptors Included	1/2" and 3/4"
Fountainheads Included:	Bell Shape & Fleur de Lis



PONDMASTER ECO 590 GPH KIT ITEM# 82435

Maximum Flow	590 GPH
Maximum Pumping Height	7.5'
Watts	40
Power	115V, 60Hz
Barbed Adaptors Included	1/2" and 3/4"
Fountainheads Included:	Bell Shape, Fleur de Lis & Double Fleur de Lis



ProLine[™]

PROLINE PRESSURIZED FILTERS

THE PROLINE PRESSURIZED FILTERS FEATURES A UNIQUE, MANUALLY OPERATED AGITATOR THAT QUICKLY DISLODGES WASTE FROM THE FILTER CHAMBER which allows you to backwash and rinse the filter in seconds without getting wet or coming in contact with fish and plant waste. Best of all, these filters never need to be opened. Available with or without an internally mounted UV Clarifier that controls green water algae.

FEATURES:

- Agitator Quickly Dislodges Waste, Conserving Water During Backwash and Rinse Cycles
- 3-Way Master Valve with "Filter," "Rinse" and "Backwash" Settings
- Clear-view Inspection Port to Monitor Water Clarity During Backwash/Rinse Operation
- Stainless Steel Clamp to Ensure a Water Tight Seal
- Bio-Matrix™ Media Provides Maximum Surface Area for Beneficial Bacteria Growth
- Heavy Duty Poly Canister Can Be Buried for Hidden Installation
- Integrated Waterproof UV Transformer (for Models Equipped with UV Clarifier)
- Optional Field Installed Bottom Drain Available (Not Included)
- 1 ½" Swivel Fittings and Ball Valve Included
- Packed 1 Per Master Carton

WITHOUT UV CLARIFIER

P-1000 • ITEM# 05010

1000 Gallon Capacity, without UV Clarifier
Recommended Pump Size: 900 - 2000 GPH
with 20' Max Total Head Height

P-2000 • ITEM# 05020

2000 Gallon Capacity, without UV Clarifier
Recommended Pump Size: 1000 - 2000 GPH
with 20' Max Total Head Height

P-4000 • ITEM# 05040

4000 Gallon Capacity, without UV Clarifier
Recommended Pump Size: 1000 - 4000 GPH
with 20' Max Total Head Height

WITH UV CLARIFIER

PUV-1000 • ITEM# 05015

1000 Gallon Capacity, with 10 Watt UV Clarifier
Recommended Pump Size: 900 - 2000 GPH
with 20' Max Total Head Height

PUV-2000 • ITEM# 05025

2000 Gallon Capacity, with 20 Watt UV Clarifier
Recommended Pump Size: 1000 - 2000 GPH
with 20' Max Total Head Height

PUV-4000 • ITEM# 05045

4000 Gallon Capacity, with 40 Watt UV Clarifier
Recommended Pump Size: 1000 - 4000 GPH
with 20' Max Total Head Height

INCLUDED 3-WAY MASTER SWIVEL FITTINGS MAKE CONNECTING AND REMOVING FLEXIBLE TUBING EASIER AND QUICKER.



**FEATURES
AN AGITATOR;
NO NEED TO
EVER OPEN
THE FILTER**



PROLINE PRESSURIZED FILTERS

ProLine™



UV CLARIFIER CONVERSION KIT FOR PRESSURE FILTERS

Add the Benefit of an Ultraviolet Clarifier to your existing Pondmaster/ProLine Low Pressure Filter. Helps clear pond of green water algae. It's easy to install and includes a 10, 20, or 40 Watt UV lamp with 9000 hour lamp life, high quality quartz sleeves, and submersible transformer with 18' power cord.

10 WATT CONVERSION KIT • ITEM# 15210

For Use with Pondmaster and ProLine Low Pressure Filters: Model PF-2000 (ITEM# 05310) and Model P-1000 (ITEM# 05010)

20 WATT CONVERSION KIT • ITEM# 15220

For Use with Pondmaster and ProLine Low Pressure Filters: Model PF-2000 (ITEM# 05310) and Model P-2000 (ITEM# 05020)

40 WATT CONVERSION KIT • ITEM# 15240

For Use with Pondmaster and ProLine Low Pressure Filters: Model PF-3000 (ITEM# 05340) and Model P-4000 (ITEM# 05040)

HIGH-FLOW SUBMERSIBLE WATER PUMPS

HFS PUMP 1/6 HP • ITEM# 90101

Voltage	120V 60Hz /2.7 Amps
Max. Head Height	23' (7 M)
Max. Flow	1860 GPH (117 LPM)
Speed	3450 R.P.M.
Solid Handling Capability	3/4"
Weight	9 lbs.
Dimensions (L x W x H)	7 5/8" x 5 1/4" x 12 1/2"

HFS PUMP 1/5 HP • ITEM# 90102

Voltage	120V 60Hz /3.5 Amps
Max. Head Height	28' (8.5 M)
Max. Flow	3000 GPH (193 LPM)
Speed	3450 R.P.M.
Solid Handling Capability	3/4"
Weight	10.5 lbs.
Dimensions (L x W x H)	7 5/8" x 5 1/4" x 13 1/4"

HFS PUMP 1/4 HP • ITEM# 90103

Voltage	120V 60Hz /3.5 Amps
Max. Head Height	21' (6.4 M)
Max. Flow	3270 GPH (206 LPM)
Speed	3450 R.P.M.
Solid Handling Capability	1 1/8"
Weight	13.5 lbs.
Dimensions (L x W x H)	9 1/2" x 6 1/2" x 14"

HFS PUMP 1/3 HP • ITEM# 90104

Voltage	120V 60Hz /5.0 Amps
Max. Head Height	27' (8.2 M)
Max. Flow	4800 GPH (302 LPM)
Speed	3450 R.P.M.
Solid Handling Capability	1 3/8"
Weight	14.5 lbs.
Dimensions (L x W x H)	9 1/2" x 6 1/2" x 14 1/8"

HFS PUMP 1/2 HP • ITEM# 90105

Voltage	120V 60Hz /6.0 Amps
Max. Head Height	35' (10.7 M)
Max. Flow	5904 GPH (372 LPM)
Speed	3450 R.P.M.
Solid Handling Capability	1 3/8"
Weight	17 lbs.
Dimensions (L x W x H)	9 1/2" x 6 1/2" x 14 3/4"

HFS PUMP 1.0 HP • ITEM# 90106

Voltage	120V 60Hz /8.5 Amps
Max. Head Height	44' (13.4 M)
Max. Flow	7200 GPH (454 LPM)
Speed	3450 R.P.M.
Solid Handling Capability	1 3/8"
Weight	19.5 lbs.
Dimensions (L x W x H)	9 1/2" x 6 1/2" x 15 1/4"



**GREAT FOR
LANDSCAPES,
IRRIGATION, WATER
CIRCULATION,
CASCADES,
WATERFALLS
AND MORE...**



**ALSO GREAT FOR:
POND, FOUNTAINS, FISH-FARMING, WATER
GARDENING, AQUACULTURE (WATER CIRCULATION),
AGRICULTURAL, STREAMS, WATER TRANSFER AND
WATER DRAINAGE.**

FEATURES

- Completely submersible
- 24 hour continuous duty operation
- High-capacity fluid transfer
- 2 Year Limited Warranty

VORTEX IMPELLER FOR INCREASED TORQUE FLOW

The torque flow impeller eliminates clogging and binding. Made of F.R.P. (fiberglass reinforced plastic) for minimal abrasive wear.

RUGGED MOTOR

Durable, Stainless steel. Corrosion resistant motor.

BUILT-IN THERMAL PROTECTION

Self-Resetting automatic protection against overload or overheat conditions.

HIGH QUALITY MECHANICAL SEALS

Double Silicone Carbide mechanical seals (Impeller side) for increased performance and additional abrasive resistance.

LARGE SOLID HANDLING CAPABILITY

Non-clog vortex impeller and volute designed for water containing decomposed plant matter and debris.

INCLUDES

1 1/2" and 2" Barbed Fitting: 1/6 HP, 1/5 HP & 1/4 HP
2" Barbed Fitting: 1/3 HP, 1/2 HP & 1 HP

PROLINE HY-DRIVE WATER PUMPS WITH PROTECTIVE CAGE

ProLine

PROLINE HY-DRIVE PUMPS ARE HIGH-CAPACITY PUMPS DESIGNED SPECIFICALLY FOR USE IN LARGER POND INSTALLATIONS. The Hy-Drive design combines the benefits of magnetic and direct drive technologies to deliver great performance and high efficiency in an extremely quiet, low maintenance package. The heavy-duty polypropylene enclosure has a built-in carry handle and effective molded-in debris screen. Hy-Drive pumps can be positioned vertically or horizontally and can be used as a submersible pump or as an in-line, external pumping source.

FEATURES

- Powerful, Efficient Hybrid Magnetic Induction Motor
- High-Efficiency Vortex Impeller
- Whisper Quiet Continuous Duty Operation
- Oil-Free / Fish Safe
- Convenient Carry Handle
- Submersible or In-line Operation
- Threaded Female Couplings and Fittings Included
- Extra-Long Clog Resistant Filter Screen
- Can be positioned vertically or horizontally
- 20' Grounded Power Cord
- Packed 2 per Master Carton
- 3 Year Limited Warranty

1600 HY-DRIVE • ITEM# 02663

Max. Watts/Amps:	120/1.0
Inlet:	1"
Outlet:	1"
Dimensions (L x W x H):	13" x 6 3/8" x 6"
Included Fittings:	(2) 1" Barb, (2) 1 1/4" Barb & (1) Coupling

2100 HY-DRIVE • ITEM# 02665

Max. Watts/Amps:	190/1.5
Inlet:	1"
Outlet:	1"
Dimensions (L x W x H):	13" x 6 3/8" x 6"
Included Fittings:	(2) 1" Barb, (2) 1 1/4" Barb and (1) Coupling

2600 HY-DRIVE • ITEM# 02667

Max. Watts/Amps:	270/2.2
Inlet:	1"
Outlet:	1"
Dimensions (L x W x H):	15" x 7.25" x 7.75"
Included Fittings:	(2) 1" Barb, (2) 1 1/4" Barb and (1) Coupling

PM NAME	PM ITEM#	Watts	Flow at 1'	Flow at 3'	Flow at 5'	Flow at 7'	Flow at 10'	Flow at 15'	Flow at 20'	Flow at 25'	Shut-Off (Feet)
PLHD 1600	02663	120	1700	1575	1400	1250	1000	375	-	-	17'
PLHD 2100	02665	190	2075	1900	1750	1600	1300	850	300	-	22' 5"
PLHD 2600	02667	270	2550	2525	2450	2225	1975	1625	1250	300	26' 5"
PLHD 3200	02680	160	3300	2700	2050	1650	650	-	-	-	12'
PLHD 4000	02675	200	4000	3300	2700	2350	1475	-	-	-	13'
PLHD 4800	02670	280	5000	4500	3900	3150	2350	800	-	-	18' 5"
PLHD 6000	02683	675	5500	5100	4700	4200	3650	2450	1150	-	22' 5"



PUMP CAN BE POSITIONED VERTICALLY OR HORIZONTALLY



316 STAINLESS STEEL ROTOR FOR GREATER CORROSION & WEAR RESISTANCE



ProLine Hy-Drive inside of Pump Bag (sold separately). See page 34 for options.



3200 HY-DRIVE • ITEM# 02680

Max. Watts/Amps:	160/1.5
Inlet:	1 1/2"
Outlet:	1 1/2"
Dimensions (L x W x H):	15" x 7.25" x 7.75"
Included Fittings:	(2) 1 1/2" Barb and (1) Coupling

4000 HY-DRIVE • ITEM# 02675

Max. Watts/Amps:	200/1.85
Inlet:	2"
Outlet:	1 1/2"
Dimensions (L x W x H):	15" x 7.25" x 7.75"
Included Fittings:	(2) 1 1/2" Barb and (1) Coupling

4800 HY-DRIVE • ITEM# 02670

Max. Watts/Amps:	280/2.15
Inlet:	1 1/2"
Outlet:	1 1/2"
Dimensions (L x W x H):	15" x 7.25" x 7.75"
Included Fittings:	(2) 1 1/2" Barb and (1) Coupling

6000 HY-DRIVE • ITEM# 02683

Max. Watts/Amps:	675/5.5
Inlet:	2"
Outlet:	2"
Dimensions (L x W x H):	15 1/2" x 7" x 8"
Included Fittings:	(1) Coupling

PROLINE SKIMMER PUMPS WITH HY-DRIVE TECHNOLOGY

PROLINE HY-DRIVE SKIMMER PUMPS ARE DESIGNED TO FIT MOST POND SKIMMER FILTERS WHILE DELIVERING RELIABLE AND POWERFUL PERFORMANCE. WITH OUR HY-DRIVE TECHNOLOGY, THESE CONTINUOUS DUTY PUMPS MOVE LARGE VOLUMES OF WATER SILENTLY AND EFFICIENTLY THROUGH FILTRATION SYSTEMS OR TO A WATERFALL, STREAM OR FOUNTAIN.

FEATURES

- Designed to Move Large Volumes of Water, Silently and Efficiently
- High Efficiency Vortex Impeller
- Upright Unique Design Specifically for Pond Skimmer Use
- Rigid Pre-Filter Stabilizes Pump while Protecting it from Large Debris
- Pump Bag Included for Extra Pump Protection
- 20' Grounded Power Cord
- Packed 2 per Master Carton
- 3 Year Limited Warranty

2550 GPH SKIMMER PUMP • ITEM# 20355

Max. Flow Rate	2550 GPH
Max. Pumping Height	11' 5"
Max. Watts/Amps	147/1.3 A
Included Fittings:	1 1/2" Coupling, 1 1/2" Stepped Barb and 1 1/2" Elbow Fitting

5100 GPH SKIMMER PUMP • ITEM# 20360

Max. Flow Rate	5100 GPH
Max. Pumping Height	30'
Max. Watts/Amps	439/3.6 A
Included Fittings:	1 1/2" Coupling, 2" Coupling, 2" to 1 1/2" Reducer, 1 1/2" Stepped Barb, 2" Stepped Barb and 1 1/2" Elbow Fitting

6600 GPH SKIMMER PUMP • ITEM# 20365

Max. Flow Rate	6600 GPH
Max. Pumping Height	30' 6"
Max. Watts/Amps	593/4.9 A
Included Fittings:	1 1/2" Coupling, 2" Coupling, 2" to 1 1/2" Reducer, 1 1/2" Stepped Barb, 2" Stepped Barb and 1 1/2" Elbow Fitting



UPRIGHT
UNIQUE
DESIGN
SPECIFICALLY
FOR POND
SKIMMERS



PROLINE PRO1000 & PRO2000 FILTER AND FALLS

ProLine

FEATURES

- Wide Spillway for Greater Water Aeration
- Easily Buried In Ground To Hide Box from Sight
- Made of High Impact Polypropylene
- Includes Stepped Barb Fittings to Accommodate 3/4", 1", 1 1/4" and 1 1/2" Tubing
- Designed to Accommodate Addition of Mechanical or Biological Filter Media for Super Clean Water
- Packed 4 Per Master Carton



SLEEK
DESIGN AND
WIDER SPILLWAY
FOR GREATER
WATER
AERATION

PRO1000 WATERFALL BOX • ITEM# 02477

(Media or Filter Not Included)

PRO1000 WITH BIOMATRIX MEDIA • ITEM# 02478

PRO1000 WITH DEBRIS FILTER - ITEM# 02479

Unit Dimensions	8 3/4" L x 12" W x 6 1/2" H
Waterfall Width	8" Opening
Container Capacity	1 Gallon
Maximum Pump Flow	950 GPH

PRO2000 WATERFALL BOX • ITEM# 02467

(Media or Filter Not Included)

PRO2000 WITH BIOMATRIX MEDIA • ITEM# 02468

PRO2000 WITH DEBRIS FILTER • ITEM# 02469

Unit Dimensions	12 3/4" L x 12 1/4" W x 8" H
Waterfall Width	11 1/4" Opening
Container Capacity	1.5 Gallon
Maximum Pump Flow	2000 GPH

CALL YOUR DANNER REPRESENTATIVE TO FIND OUT ABOUT OUR BULK PACKED PALLET

PROLINE PRO3000 FILTER AND FALLS

FEATURES

- Extra-Wide Spillway for Greater Water Aeration
- Baffle Chamber for Even and Efficient Waterfall Flow Through the Filter Media
- Easily Buried In Ground To Hide Box from Sight
- Holds More Friendly Bacteria to Help Filtration
- Made of High Impact Polypropylene
- Extra Long Weir Lip for Stacking Stones in Front of Waterfall
- Pre-Bored Inlet Size of 2 1/2"
- Includes Bulkhead Fitting and 1 1/2" Barbed Fitting
- Packed Individually



EXTRA
LONG WEIR
LIP FOR
STACKING STONES
IN FRONT OF
WATERFALL

PRO3000 WATERFALL BOX • ITEM# 02481

(Media or Filter Not Included)

PRO3000 WITH BIOMATRIX MEDIA • ITEM# 02480

PRO3000 WITH DEBRIS FILTER • ITEM# 02482

Unit Dimensions	16" L x 18" W x 13" H
Waterfall Width	16" Opening
Container Capacity	4 Gallon
Maximum Pump Flow	3000 GPH

PM NAME	PM ITEM#	Watts	Flow at 1'	Flow at 3'	Flow at 5'	Flow at 7'	Flow at 10'	Flow at 15'	Flow at 20'	Flow at 25'	Flow at 30'	Shut-Off (Feet)
SKP 2550	20355	147	2375	2000	1500	1050	450	-	-	-	-	11' 6"
SKP 5100	20360	439	5100	5050	4650	4375	3900	3050	2375	1675	-	30'
SKP 6600	20365	593	6600	6275	5500	4925	4325	3325	2425	1850	550	30' 6"

PROLINE PRO5000 FILTER AND FALLS

FEATURES

- Extra Wide Spillway for Greater Water Aeration
- Can be used Side by Side to Create a Larger Waterfall
- Open Swirl Chamber for Even and Efficient Water Flow through The Filter Media
- 3 Separate Filtering Actions for Super Clean Water
- Easily Buried In Ground To Hide Canister from Sight
- XL Capacity Designed To Increase Biological Filtration
- Upflow Grate Contains Media and Assures Uniform Filtering
- Available with Coarse Debris Pad which Removes Even the Finest Suspended Debris From Pond Water
- Extra Long Weir Lip For Stacking Stones In Front of the Waterfall
- Includes 1 1/2" Barbed, 2" Slip and Bulkhead fitting
- Packed Individually

PRO5000 FILTER AND FALLS WITH BIOMATRIX MEDIA • ITEM# 02490

PRO5000 FILTER AND FALLS WITH DEBRIS PAD • 02492

Unit Dimensions	18" L x 25" W x 17" H
Waterfall Width	18" Opening
Media Surface Area	75 Sq. Ft.
Maximum Pump Flow	5000 GPH
Weight	10 lbs.



PROLINE PRO5000 SKIMMER

PROLINE SKIMMERS have been designed to promote healthy pond life by capturing floating organic debris such as leaves, plants, flowers, grass and twigs into the skimmer basket before they can settle to the pond bottom, which will eventually create a layer of sludge. If left unattended, this will begin decaying and start to produce ammonia. Ammonia buildup can become highly toxic to delicate fish and aquatic life.

FEATURES

- Strong Ribbed Cylindrical Housing Eliminates Cave-Ins
- Made from Heavy Duty High Density Polyethylene
- Ribs Anchor the Skimmer Solidly in Place, No Shifting or Heaving
- Tall 7" x 11" Wide Door for Efficient Skimming Over a Wide Range of Water Levels
- Install 2 Pumps in the Same Skimmer for Massive Flows and Maximum Efficiency
- Large Capacity Clog Resistant Leaf Basket that Keeps Debris Away from the Pump
- Accommodates Most Pumps Up to 8,000 GPH
- Versatile Bulkhead Placement Allows Multiple Inlets and Fittings Up to 2"
- Skimmer Lid Supports 300 lbs.
- For Maximum Cleaning, Use with Clearguard or ProLine Pressurized Filter Systems.
- Includes 1 1/2" Barbed, 2" Slip and Bulkhead fitting
- Packed Individually

WITH DEBRIS PAD

- Quickly Removes Fine Particulates Such as Floating Dust and Pollen which helps polish pond water
- Provides Ideal Medium for Biological Filtration
- Bypass Slotting Ensures Water Flow to Protect Pump Even When Pad Needs Cleaning
- Easily Cleaned and Inexpensive to Replace

PRO5000 SKIMMER • ITEM# 02475

PRO5000 SKIMMER WITH DEBRIS PAD • ITEM# 02474

Weir Size Opening	11" W x 7" H
Unit Dimensions	24" L x 26" W x 23" H
Max. Pump Capacity	8,000 GPH
Operating Surface Area	500 Sq. Ft.
Weight	18 lbs.



Item 02474 with Debris Filter

PROLINE PUMP VAULTS

ProLine

PROLINE VAULTS ARE STURDY HOUSINGS USED IN SELF-CONTAINED WATERFALLS AND STREAMS.

They will accommodate submersible pumps up to 10,000 GPH and are specially designed to withstand clogs and heavy stones. Create your own dramatic natural looking water highlight that offers all the beauty and pleasing sounds of a waterfall in a fraction of the space. A self-contained waterfall or stream is easy to install and even easier to maintain. Best of all, it's pet and child safe. ProLine Pump Vaults are the basis for creating a long lasting, trouble-free installation.

FEATURES

- Acts As A Pre-Filter to Protect Submerged Pump Intakes from Getting Clogged with Gravel or Debris
- Built of Rugged, Weather-Resistant Polyethylene Plastic
- Horizontal Hooded Intake Slots Resist Clogging and Sedimentation from Top to Bottom
- Reinforced Lid Withstands The Weight of Gravel and Stones
- Works Great For Free Standing Fountains, Endless Streams and Waterfalls
- Buttressed To Withstand Backfilling Without Warping or Collapsing
- Pre-Bored for 1 1/2" and 2" Pipe with Bulkheads for Auto Fill Valve on 2000 and 4800; Auto Fill Valve Included with Pro 4800
- Packed Individually

PRO2000 MINI PUMP VAULT • ITEM# 02465

Maximum Pump Flow	4000 GPH
Unit Dimensions	15" L x 15" W x 17" H
Weight	12 lbs.

PRO4800 PUMP VAULT • ITEM# 02460

Maximum Pump Flow	10,000 GPH
Unit Dimensions	23" L x 23" W x 25" H
Weight	16 lbs.

**FEATURES
HORIZONTAL
HOODED INTAKE
SLOTS; RESIST
CLOGGING AND
SEDIMENTATION
FROM TOP
TO BOTTOM**



02465



02460

PROLINE APP-CONTROLLED MULTI-COLOR LED SPILLWAYS

PROLINE APP-CONTROLLED MULTI-COLOR LED SPILLWAYS for self-contained Waterfalls, Hardscapes, Retaining Walls and anywhere else you desire the beauty and tranquility of soothing flowing water. ProLine App-Controlled Multi-Color LED Spillways are iOS and Android compatible using the Smart Life App, which is available for free within the Apple App Store or Google Play Store. Connect to Smart Life utilizing the Spillway's integrated 2.4 GHz WiFi controller (no secondary hub required) to control the lighting within the LED Spillway, now making your mobile device your remote control. This eliminates the need for a separate remote and the hassle of changing batteries or losing it.

Explore the infinite color possibilities within Smart Life and its adjustable color settings to suit your needs. It features 8 pre-programmed scenes: 4 scenes designed as Night, Reading, Party and Leisure while the other 4 scenes; Soft, Rainbow, Shine and Gorgeous can be adjusted based on your mood. You can also set up multiple schedules to turn the lighting on/off according to your desired preset time.

FEATURES

- App-Controlled LED Spillway compatible w/ iOS and Android devices
- Free 'Smart Life' App available in the Apple App Store or Google Play Store
- Your mobile device is your remote control, Eliminates the need for a separate remote
- Connect w/ the Spillways waterproof 2.4 GHz WiFi controller
- Infinite color possibilities w/ adjustable settings
- Works w/ Voice Control via Amazon Echo, Alexa, Google Home and/or Assistant
- Interior baffling system that produces a single, lighted water sheet
- Reinforced opening with 5" Lip Extension
- 12" Spillway: Bottom Mount with included 3/4" to 1 1/4" Stepped Barbed Fitting
- 24" and 36" Spillway: Bottom Mount with integrated 1 1/2" Female Threaded Connection
- 43' power cord length w/ rain-proof transformer & waterproof WiFi controller
- Recommended pump sizes: 1200 GPH for 12" Spillway, 2400 GPH for 24" Spillway and 3600 GPH for 36" Spillway
- 1 Year Limited Warranty
- 12" Spillway: 4 per Master Carton. 24" Spillway: 2 per Master Carton 36" Spillway: 1 per Master Carton

INFINITE
COLOR
POSSIBILITIES
WITH 8 PRE-
PROGRAMMED
SCENES



SCAN CODE USING YOUR SMART DEVICE CAMERA. THIS WILL DIRECTLY TAKE YOU TO THE APPLE APP STORE OR GOOGLE PLAY STORE TO DOWNLOAD SMART LIFE FOR FREE.



ProLine

PROLINE APP-CONTROLLED MULTI-COLOR LED SPILLWAYS

PROLINE APP-CONTROLLED 24" MULTI-COLOR LED SPILLWAY - ITEM# 03702

Product Dimension: 24" W x 8" D x 4" H



PROLINE APP-CONTROLLED 12" MULTI-COLOR LED SPILLWAY • ITEM# 03701

Product Dimension: 12" W x 8" D x 4" H



PROLINE APP-CONTROLLED 36" MULTI-COLOR LED SPILLWAY • ITEM# 03703

Product Dimension: 36" W x 8" D x 4" H



amazon alexa & echo

Smart Life and its logo is a registered trademark of Smart Inc., Apple, App Store and its logos are registered trademarks of Apple Inc., Amazon, Alexa, Echo and its logos are registered trademarks of Amazon.com, Inc., Google Play, Home, Assistant and its logos are registered trademarks of Google LLC. All Rights Reserved.

Supreme AQUARIUM

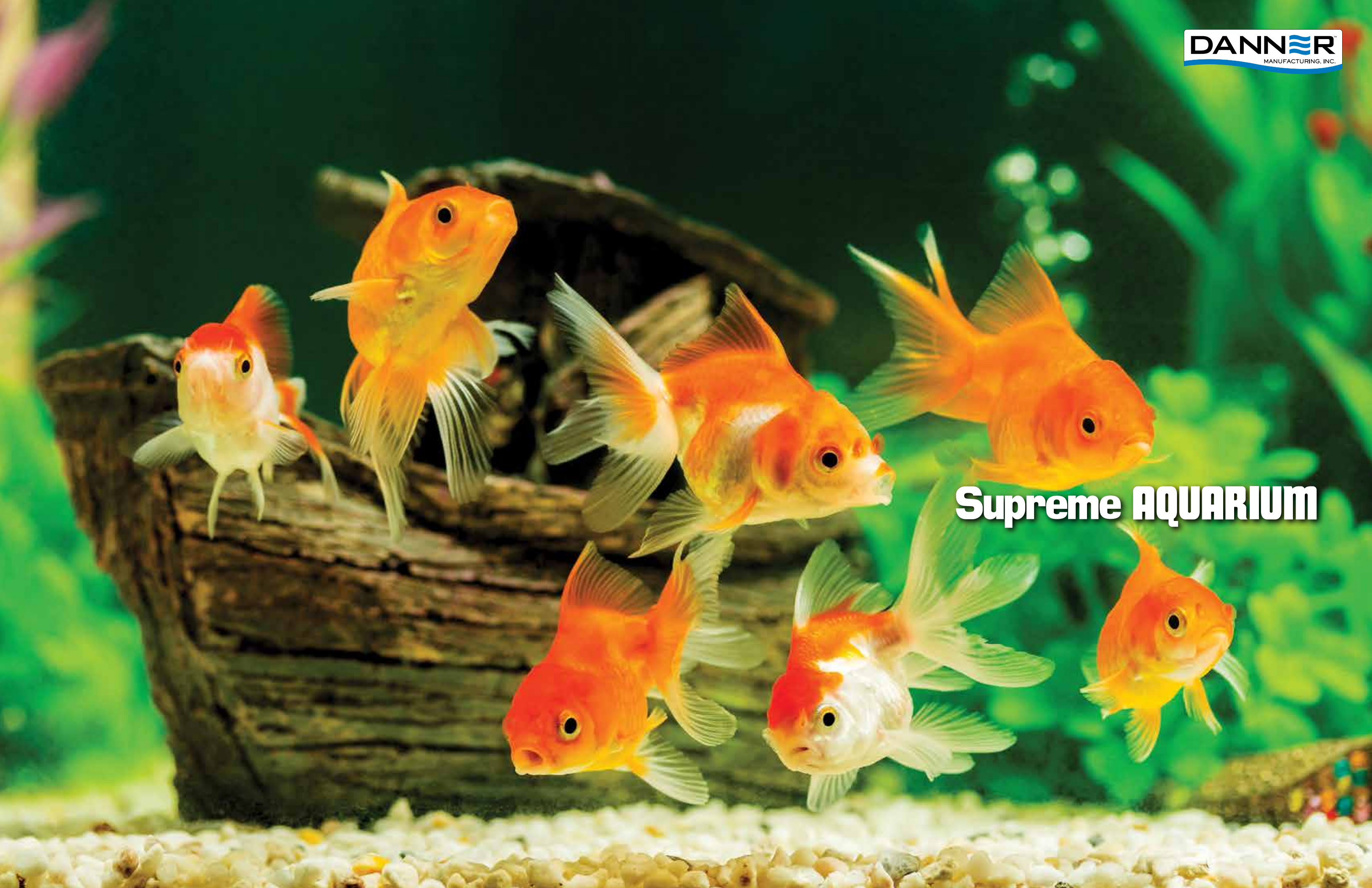

SUPREME AQUA-MAG[®] MAGNETIC DRIVE WATER PUMPS

SUPREME AQUA-MAG[®] 250 to 3600 SERIES PUMPS are ideal for saltwater or freshwater aquariums and can operate in-line or submerged, with quiet, efficient and reliable 24/7 performance. They feature a magnet impeller assembly and an epoxy encased power unit ensuring that water never gets contaminated with harmful oils or chemicals.



FEATURES

- Reusable Debris Pre-Filter
- Operates Submerged or In-Line
- 10' Grounded Power Cord
- Energy Efficient
- Models 2, 3, 5 and 7 Made in USA
- Models 2, 3, 5 and 7 - 1/2" FPT Inlet, MPT Outlet
- Models 9.5, 12 and 18 - 3/4" FPT Inlet, MPT Outlet
- Model 24 and 36 - 1" FPT Inlet, MPT Outlet
- Packed 6 per Master Carton (250 to 700)
- Packed 2 per Master Carton (950 to 3600)
- 5 Year Limited Warranty

AQUA-MAG 250 Maximum Flow Rate Recommended Tank Size	ITEM# 02512 250 GPH 30 Gallons
AQUA-MAG 350 Maximum Flow Rate Recommended Tank Size	ITEM# 02513 350 GPH 40 Gallons
AQUA-MAG 500 Maximum Flow Rate Recommended Tank Size	ITEM# 02515 500 GPH 60 Gallons
AQUA-MAG 700 Maximum Flow Rate Recommended Tank Size	ITEM# 02517 700 GPH 85 Gallons
AQUA-MAG 950 Maximum Flow Rate Recommended Tank Size	ITEM# 02710 950 GPH 110 Gallons

AQUA-MAG 1200 Maximum Flow Rate Recommended Tank Size	ITEM# 02712 1200 GPH 150 Gallons
AQUA-MAG 1800 Maximum Flow Rate Recommended Tank Size	ITEM# 02718 1800 GPH 225 Gallons
AQUA-MAG 2400 Maximum Flow Rate Recommended Tank Size	ITEM# 02740 2400 GPH 300 Gallons
AQUA-MAG 3600 Maximum Flow Rate Recommended Tank Size	ITEM# 02745 3100 GPH 450 Gallons

PUMPING SPECIFICATIONS

MODEL	ITEM#	WATTS	FLOW AT 1'	FLOW AT 2'	FLOW AT 3'	FLOW AT 4'	FLOW AT 5'	FLOW AT 6'	FLOW AT 7'	FLOW AT 8'	FLOW AT 9'	FLOW AT 10'	FLOW AT 15'	SHUTOFF (FEET)
250 GPH	02512	24	280	230	170	130	65	25	-	-	-	-	-	6' 5"
350 GPH	02513	35	420	375	325	280	235	190	140	90	30	-	-	10' 4"
500 GPH	02515	45	525	450	400	350	300	235	200	150	95	-	-	10' 6"
700 GPH	02517	70	655	605	565	530	450	420	325	275	200	110	-	11' 8"
950 GPH	02710	93	1010	930	900	840	770	710	650	600	530	475	-	13' 7"
1200 GPH	02712	110	1190	1130	1065	940	900	840	795	730	630	570	-	13' 7"
1800 GPH	02718	145	1300	1240	1170	1130	1040	1015	925	880	810	775	470	16' 6"
2400 GPH	02740	237	2400	2350	2190	2030	1860	1730	1645	1510	1395	1380	830	17' 1"
3600 GPH	02745	256	3060	2885	2775	2670	2595	2480	2365	2295	2205	2170	1615	22' 6"

SUPREME AQUA-MAG[®] AIR FRACTIONATING WATER PUMPS

Supreme AQUARIUM

SUPREME AQUA-MAG AIR FRACTIONATING WATER PUMPS are ideal to maximize dissolved oxygen levels in freshwater, saltwater and reef aquariums. The pumps' uniquely designed shaft and impeller design breaks up the in-flowing water and creates tiny bubbles that add vital oxygen to the aquarium water. The pump is equipped with a reusable debris pre-filter and a 18" vinyl aerating tube with Noise-Suppressing muffler that allows for reliable and quiet use.

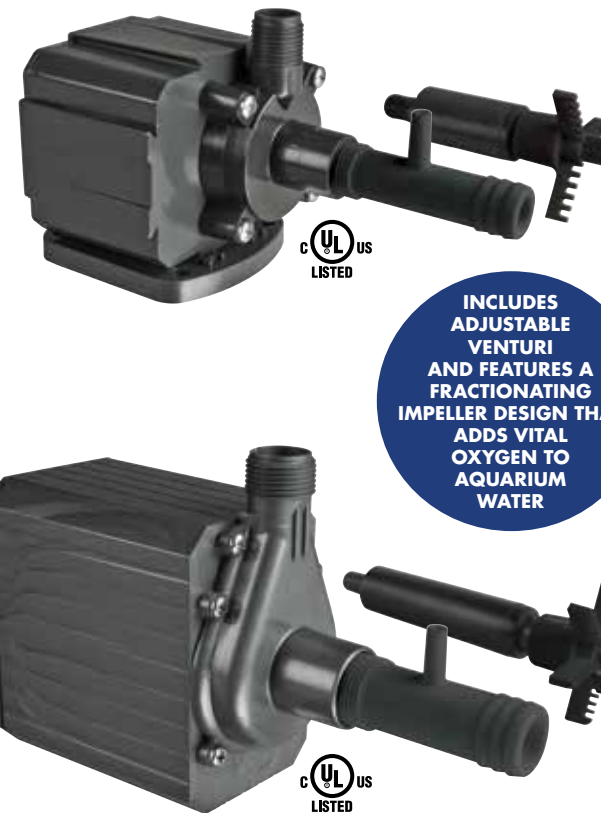

INCLUDES ADJUSTABLE VENTURI AND FEATURES A FRACTIONATING IMPELLER DESIGN THAT ADDS VITAL OXYGEN TO AQUARIUM WATER



FEATURES

- Front-Mount Adjustable Venturi
- Unique Ceramic Shaft Fractionating Impeller Design
- 18" Vinyl Aerating Tube with Noise-Suppressing Muffler
- Reusable Debris Pre-Filter
- Operates Submerged or In-Line
- 10' Grounded Power Cord
- Models 2, 3, 5 and 7 Made in USA
- Models 2, 3, 5 and 7 - 1/2" FPT Inlet, MPT Outlet and Venturi is Barbed to Accept 3/4" Flexible Tubing.
- Models 9.5, 12 and 18 have 3/4" FPT Inlet, MPT Outlet and Venturi is Barbed to Accept 1" Flexible Tubing
- Packed 6 per Master Carton (250 to 700)
- Packed 2 per Master Carton (950 to 1800)
- 5 Year Limited Warranty

MODEL 2 Maximum Flow Rate	ITEM# 06002 250 GPH	MODEL 9.5 Maximum Flow Rate	ITEM# 06010 950 GPH
MODEL 3 Maximum Flow Rate	ITEM# 06003 350 GPH	MODEL 12 Maximum Flow Rate	ITEM# 06012 1200 GPH
MODEL 5 Maximum Flow Rate	ITEM# 06005 500 GPH	MODEL 18 Maximum Flow Rate	ITEM# 06018 1800 GPH
MODEL 7 Maximum Flow Rate	ITEM# 06007 700 GPH		

AIR FRACTIONATING WATER PUMP SPECIFICATIONS

PUMP	MAX. OUTPUT		MAX. PUMP HEIGHT		WATTS
	GPH	LITERS/HOUR	FEET	METERS	
MODEL 2	250	940	6' 4"	1.95	24
MODEL 3	350	1300	10' 3"	3.15	35
MODEL 5	500	1900	10' 5"	3.20	45
MODEL 7	700	2650	11' 7"	3.55	70
MODEL 9.5	950	3595	13' 6"	4.15	93
MODEL 12	1200	4500	13' 6"	4.15	110
MODEL 18	1800	6800	16' 5"	5.00	145

Flow rates above indicate full flow with no aeration introduced into the return water flow. As more air is introduced through the venturi assembly, flow rates will decrease.

THE AQUARIUM PUMP

FOR FRESHWATER AND SALTWATER AQUARIUMS



93 GPH thru 725 GPH Pump

Shown with In-line Volute



70 GPH Pump

FEATURES

- **VERTICAL FLOW CONTROL DESIGN INCREASES FLOW RANGE**
- For Fresh & Saltwater Aquariums
- Energy-Efficient Magnetic Drive Technology
- Models 70 thru 200 for Submersible Use Only
- Models 290 thru 725 for Submersible or In-line Use
- 6' Grounded Power Cord
- Packed 6 Per Master Carton (70 to 200)
- Packed 4 Per Master Carton (290 to 725)
- 2 Year Limited Warranty



MODEL	ITEM#	Maximum Flow Rate	Maximum Pumping Height	Cord Length	Includes Slip-Fit Tubing Adapters
70 GPH PUMP	ITEM# 06503	70 GPH	2'	6'	1/4" and 1/2"
93 GPH PUMP	ITEM# 06507	93 GPH	2.5'		1/4" and 1/2"
120 GPH PUMP	ITEM# 06513	120 GPH	3'		1/4" and 1/2"
200 GPH PUMP	ITEM# 06517	200 GPH	5.6'		1/4" and 1/2"

MODEL	ITEM#	Maximum Flow Rate	Maximum Pumping Height	Inlet Size	Includes Threaded Tubing Adapters
290 GPH PUMP	ITEM# 06523	290 GPH	6.5'	1/2" MPT	1/2", 5/8" and 3/4"
400 GPH PUMP	ITEM# 06527	400 GPH	8.5'	1/2" MPT	1/2", 5/8" and 3/4"
530 GPH PUMP	ITEM# 06533	530 GPH	9'	1/2" MPT	1/2", 5/8" and 3/4"
725 GPH PUMP	ITEM# 06537	725 GPH	12'	1/2" MPT	1/2", 5/8" and 3/4"

MODEL	FLOW AT 0'	FLOW AT 2'	FLOW AT 4'	FLOW AT 6'	FLOW AT 8'	SHUTOFF	WATTS	AMPS
70 GPH	70	-	-	-	-	2'	3W	.03A
90 GPH	93	20	-	-	-	2.5'	6W	.07A
120 GPH	120	50	-	-	-	3'	6.5W	.08A
200 GPH	200	140	85	35	-	5.6'	14W	.19A
290 GPH	290	270	205	50	-	6.5'	17W	.24A
400 GPH	400	360	285	155	30	8.5'	30W	.45A
530 GPH	530	500	420	305	135	9'	50W	.68A
725 GPH	725	690	615	515	420	12'	70W	.50A

SUPREME[®] HY-DRIVE MAGNETIC DRIVE WATER PUMP

FOR FRESHWATER AQUARIUMS

Supreme AQUARIUM

SUPREME AQUARIUM HY-DRIVE WATER PUMPS are rugged, powerful and energy-efficient, ideal for use in freshwater aquariums. All pumps come with a full set of fittings.



316 STAINLESS STEEL ROTOR FOR GREATER CORROSION & WEAR RESISTANCE

FEATURES

- For Freshwater Aquariums*
- Powerful, Efficient Hybrid Magnetic/Direct Drive Motor
- Energy-Efficient to Reduce Operating Cost
- Whisper-Quiet Operation
- Specifically Designed for Freshwater Aquariums
- Oil-Free / Fish Safe
- Continuous Duty Operation
- Integrated Filter Screen for Clog-Resistant Operation
- 20' Power Cord with Grounded Plug
- In-line and Submersible Operation
- Convenient Base Plate Included
- Packed 2 Per Master Carton
- 3 Year Limited Warranty

MODEL	ITEM#	Maximum Flow Rate	Max. Watts/Amps	Included Fittings
1600 HY-Drive Pump	ITEM# 02583	1600 GPH	120/1.0	(2) 1" Barb, (2) 1 1/4" Barb, (1) Coupling
2100 HY-Drive Pump	ITEM# 02582	2100 GPH	190/1.5	(2) 1" Barb, (2) 1 1/4" Barb, (1) Coupling
2600 HY-Drive Pump	ITEM# 02581	2600 GPH	270/2.2	(2) 1" Barb, (2) 1 1/4" Barb, (1) Coupling
3200 HY-Drive Pump	ITEM# 02580	3200 GPH	160/1.5	(2) 1 1/2" Barb, (1) Coupling
4000 HY-Drive Pump	ITEM# 02575	4000 GPH	200/1.85	(2) 1 1/2" Barb, (1) Coupling
4800 HY-Drive Pump	ITEM# 02570	4800 GPH	280/2.15	(2) 1 1/2" Barb, (1) Coupling
6000 HY-Drive Pump	ITEM# 02572	6000 GPH	675/5.5	(1) Coupling

HY-DRIVE PUMPING SPECIFICATIONS														
MODEL	ITEM#	NOMINAL	AMPS	WATTS	GPH AT 0'	GPH AT 1'	GPH AT 3'	GPH AT 5'	GPH AT 7'	GPH AT 10'	GPH AT 15'	GPH AT 20'	GPH AT 25'	SHUTOFF
1600	02583	1600	1.0 A	120	1750	1700	1575	1400	1250	1000	375	-	-	17'
2100	02582	2100	1.5 A	190	2125	2075	1900	1750	1600	1300	850	300	-	22.5'
2600	02581	2600	2.2 A	270	2700	2550	2525	2450	2225	1975	1625	1250	300	26.5'
3200	02580	3200	1.6 A	160	3500	3300	2700	2050	1650	650	-	-	-	12'
4000	02575	4000	1.9 A	230	4300	4000	3300	2700	2350	1475	-	-	-	13'
4800	02570	4800	2.0 A	250	5100	5000	4500	3900	3150	2350	800	-	-	18.5'
6000	02572	6000	5.5 A	675	5700	5500	5100	4700	4200	3400	2450	1150	-	22.5'

*Not for use in Saltwater Aquariums

SUPREME® EZ CLEAN EXTERNAL FILTER

FOR FRESHWATER AND SALTWATER AQUARIUMS

INNOVATIVE WATER-CHANGE FEATURE

REMOVES AND REFILLS AQUARIUM WATER



BUILT-IN GRAVEL CLEANER

SAFELY AND EASILY PULLS DEBRIS FROM GRAVEL WHILE RETURNING FILTERED WATER BACK TO AQUARIUM



COMPLETE WATER FILTRATION

FILTER MECHANICALLY, CHEMICALLY & BIOLOGICALLY



EZ CLEAN EXTERNAL FILTER • ITEM# 01105

- Patented All-In-One Filter with Built-in Gravel Vacuum
- Dual Cartridge System with Replaceable Media (See Page 68 for Replacement Media)
- No Need to Purchase a Separate Siphon for Water Change
- Gravel Cleaner Includes Flexible Tubing and Mesh Filter Bag
- Can Be Used with Fresh or Saltwater Aquariums up to 55 Gallons
- Product Dimensions: 10 7/8" W x 5 1/2" D x 8 3/4" H for the filter in the tank without intake tube. With intake tube attached the height goes from 8 3/4" to 14" H
- Weight: 3.37 lbs
- Packed 2 Per Master Carton

PATENTED ALL-IN-ONE EXTERNAL FILTER



SUPREME® EZ CLEAN INTERNAL FILTERS

FOR FRESHWATER AND SALTWATER AQUARIUMS

INNOVATIVE WATER-CHANGE FEATURE

REMOVES AQUARIUM WATER

DUAL INTERNAL FILTER • ITEM# 01160

- Patented Dual Cartridge System with Replaceable Media (See Page 68 for Replacement Media)
- No Need to Purchase a Separate Siphon for Water Change
- Unique Top Loading Cartridge Design
- Can be used with Fresh or Saltwater Aquariums up to 55 Gallons
- Product Dimensions: 7" W x 4 3/4" D x 8 1/2" H for the filter in the tank without intake tube. With intake tube attached the height goes from 8 1/2" to 14" H
- Weight: 2.6 lbs
- Packed 2 Per Master Carton

PATENTED DUAL & SINGLE CARTRIDGE INTERNAL FILTERS

SINGLE INTERNAL FILTER • ITEM# 01155

- Patented Single Cartridge System with Replaceable Media (See Page 68 for Replacement Media)
- No Need to Purchase a Separate Siphon for Water Change
- Unique Top Loading Cartridge Design
- Can be used with Fresh or Saltwater Aquariums up to 30 Gallons
- Product Dimensions: 6" W x 4" D x 8 1/2" H for the filter in the tank without intake tube. With intake tube attached the height goes from 8 1/2" to 14" H
- Weight: 2.32 lbs
- Packed 2 Per Master Carton

ADJUSTABLE AERATION VENTURI

ALLOWS FOR AERATION FLOW CONTROL

COMPLETE WATER FILTRATION

FILTER MECHANICALLY, CHEMICALLY & BIOLOGICALLY



Dual Internal Filter

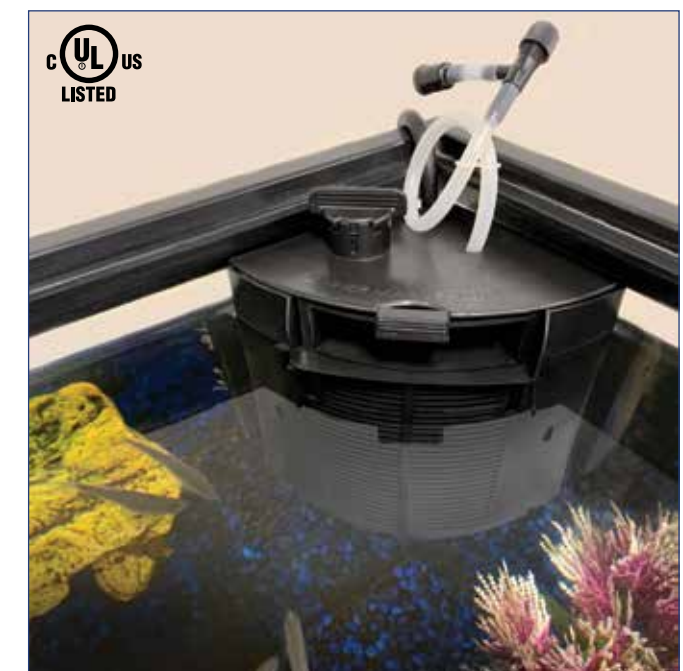

Single Internal Filter

Supreme AQUARIUM



SUBSCRIBE TO OUR YOUTUBE CHANNEL AND VIEW OUR EZ CLEAN FILTER PRODUCT VIDEOS!

WWW.YOUTUBE.COM/DANNERMFG

SUPREME® SKILTER™ PROTEIN SKIMMERS

FOR SALTWATER AQUARIUMS

PATENTED SUPREME SKILTER™ IS A UNIQUE COMBINATION OF A PROTEIN SKIMMER AND AN AERATING POWER FILTER FOR USE IN SALTWATER AQUARIUMS.

The venturi enables air to be injected into the water creating millions of very fine bubbles. Potentially dangerous protein compounds and toxins adhere to the bubbles creating a froth. This frothy waste pushes its way up into the collection tray where it can be harmlessly disposed of.

It features a large filter box, which can accommodate supplemental filter media in conjunction with the unique Bio-Matrix filter cartridge. It's state-of-the-art, energy-efficient motor uses a single moving part to operate. Manufactured from heavy duty plastic, the Skilter will give years of trouble-free operation, even in the adverse conditions which are common to saltwater aquariums.



SKILTER 250 • ITEM# 01031

Skilter 250 is recommended for aquariums between 10-55 gallons and can be used as a supplemental filter on larger aquariums. The protein skimmer will operate effectively on aquariums up to 125 gallons. The Skilter 250 has a flow rate up to 250 gallons per hour and includes a dual-media Bio-Matrix filter cartridge. Packed 6 Per Master Carton.



PATENTED COMBO: PROTEIN SKIMMER AND AERATING POWER FILTER



SKILTER 400 • ITEM# 01033

Skilter 400 is recommended for aquariums between 30-100 gallons and can be used as a supplemental filter on larger aquariums. The protein skimmer will operate effectively on aquariums up to 125 gallons. The Skilter 400 has a flow rate up to 400 gallons per hour and includes two dual-media Bio-Matrix filter cartridges. Packed 6 Per Master Carton.



SUPREME® OVATION SUBMERSIBLE POWER JET FILTERS

FOR AQUARIUMS AND TERRARIUMS

Supreme AQUARIUM

OVATION FILTERS have been designed for hobbyists looking for powerful, quiet and effective filtration for their home aquariums and terrariums. They can be used for installations from 10 to 80 gallons if used singly, or larger installations if more than one pump is employed. They offer the right combination of mechanical, biological and chemical filtration to assure a clean habitat for aquatic pets.

Ovation Series filters include an adjustable spray bar, airflow regulator and two filtration elements (a sponge and a carbon filter). Units can be mounted vertically, or for terrariums, in a low-profile horizontal position using the included suction cups.



CAN BE MOUNTED VERTICALLY FOR SHALLOW HABITATS. GREAT FOR TERRARIUMS



FEATURES

- Innovative Design Filters up to 265 GPH
- Dual Filter Elements Provide Excellent Filtration
- Adjustable Air Regulator Allows Aeration Flow Control
- Includes Spray Bar for Enhanced Aeration
- Mounts Easily for Submersed use in any Terrarium or Aquarium
- Can be Operated in any Position, Horizontal or Vertical
- Smooth, Ultra-Quiet Operation
- Perfect for Odd-Shaped and Shallow Habitats
- Packed 12 Per Master Carton

Ovation-210 • ITEM# 01025

Maximum Flow Rate	53 GPH
Recommended Tank Size*	Up to 15 Gallons

Ovation-380 • ITEM# 01026

Maximum Flow Rate	100 GPH
Recommended Tank Size*	Up to 25 Gallons

Ovation-700 • ITEM# 01027

Maximum Flow Rate	185 GPH
Recommended Tank Size*	Up to 50 Gallons

Ovation-1000 • ITEM# 01028

Maximum Flow Rate	265 GPH
Recommended Tank Size*	Up to 80 Gallons

*Single filter use. You may use more than one filter for larger tanks.

SUPREME® OXY-FLO HIGH VOLUME AQUARIUM AIR PUMPS

FOR FRESHWATER & SALTWATER AQUARIUMS

SUPREME OXY-FLO HIGH VOLUME AIR PUMPS have been designed to satisfy the requirements of a multitude of water-related applications. The oil-less motor is designed to operate efficiently and save energy.

FEATURES

- Easy-to-Use Air Pump that Provides Oxygen to Freshwater and Saltwater Aquariums
- High Volume, Diaphragm-Driven Pump has Steady Air Flow and Requires No Lubrication
- Great for Indoor Gardening (Hydroponic) Systems
- Quiet and Reliable Operation
- Air Manifold (included)
- Energy-Efficient Motor
- Packed 2 Per Master Carton
- 1 Year Limited Warranty

GREAT FOR AERATING AQUARIUMS. INCLUDES MANIFOLD.



AP-20	ITEM# 04220
Air Volume	1700 cu.in/min
Maximum Water Depth	7'
Noise Level	40 dba
Watts	20
Weight	5 lbs
Air Manifold Outlets	6
Pressure	4.0 psi
Liters	28 L/min.
Dimensions (L x W x H)	8 1/2" x 5 1/2" x 6"
Cord Length	6'

Note: Can Accept 5/8" I.D. Tubing to Extend Distance between Air Pump and Diffuser

AP-40	ITEM# 04240
Air Volume	2900 cu.in/min
Maximum Water Depth	9.6'
Noise Level	40 dba
Watts	40
Weight	9 lbs
Air Manifold Outlets	12
Pressure	4.85 psi
Liters	47 L/min.
Dimensions (L x W x H)	9 5/8" x 6 5/8" x 7"
Cord Length	6'

Note: Can Accept 3/4" I.D. Tubing to Extend Distance between Air Pump and Diffuser

AP-60	ITEM# 04260
Air Volume	5500 cu.in/min
Maximum Water Depth	10'
Noise Level	45 dba
Watts	60
Weight	14 lbs
Air Manifold Outlets	14
Pressure	5.66 psi
Liters	90 L/min.
Dimensions (L x W x H)	10" x 7 1/2" x 8 1/2"
Cord Length	6'

Note: Can Accept 3/4" I.D. Tubing to Extend Distance between Air Pump and Diffuser

AP-100	ITEM# 04280
Air Volume	9150 cu.in/min
Maximum Water Depth	11.5'
Noise Level	45 dba
Watts	100
Weight	16.5 lbs
Air Manifold Outlets	33
Pressure	6.53 psi
Liters	150 L/min.
Dimensions (L x W x H)	11 3/4" x 8" x 8 7/8"
Cord Length	6'

Note: Can Accept 3/4" I.D. Tubing to Extend Distance between Air Pump and Diffuser

FOR A COMPLETE LIST OF REPLACEMENT DIAPHRAGM KITS AND MANIFOLDS VISIT WWW.DANNERMFG.COM

SUPREME® OXY-FLO LOW VOLUME AQUARIUM AIR PUMPS

FOR FRESHWATER & SALTWATER AQUARIUMS

Supreme AQUARIUM

SUPREME OXY-FLO AIR PUMPS ARE LOW ENERGY PUMPS THAT CAN BE USED FOR OXYGENATING SMALLER AQUARIUMS TO HELP PROMOTE HEALTHIER FISH AND AQUATIC PLANT LIFE WHILE ALSO HELPING BREAKDOWN FISH WASTE.

FEATURES

- Accepts Standard Airline Tubing
- Easy-to-Use Air Pump that Provides Oxygen to Freshwater and Saltwater Aquariums
- Quiet and Reliable Operation
- Great for Indoor Gardening (Hydroponic) Systems
- Packed 4 Per Master Carton (AP-2, AP-3 and AP-4)
- Packed 2 Per Master Carton (AP-8)

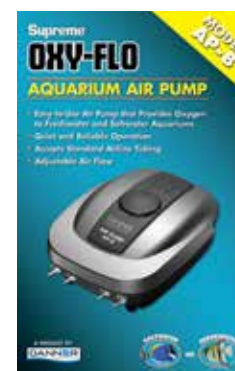

GREAT FOR AERATING SMALLER AQUARIUMS. ACCEPTS STANDARD AIRLINE TUBING



AP-2	ITEM# 06402
Air Volume	73 cu.in/min
Liters	1.2 L/min.
Maximum Water Depth	3'
Cord Length	6'
Number of Outlets	1
Watts	1.5
Pressure	0.010 MPa (1.45 psi)

AP-3	ITEM# 06403
Air Volume	110 cu.in/min
Liters	1.8 L/min.
Maximum Water Depth	3.3'
Cord Length	6'
Number of Outlets	1
Watts	2.8
Pressure	0.010 MPa (1.45 psi)

AP-4	ITEM# 06404
Air Volume	275 cu.in/min
Liters	4.5 L/min.
Maximum Water Depth	4'
Cord Length	6'
Number of Outlets	2, Flow Adjustable
Watts	3.5
Pressure	0.014 MPa (2.0 psi)

AP-8	ITEM# 06408
Air Volume	549 cu.in/min
Liters	9.0 L/min.
Maximum Water Depth	4.5'
Cord Length	6'
Number of Outlets	4, Flow Adjustable
Watts	7
Pressure	0.014 MPa (2.0 psi)

In determining the correct size of Air Pump for your Aquarium, the simple rule of thumb would be 0.03 L/min (Liters Per Minute) of air flow for each gallon of water in your Aquarium. This is only an estimate. Your actual volume may need to be higher based on your fish & plant load.

FOR A COMPLETE LIST OF REPLACEMENT DIAPHRAGM KITS VISIT WWW.DANNERMFG.COM

SUPREME® PUMPGUARD™ AND AQUA-CLEAN

SUPREME PUMPGUARD IS AN EASY MAINTENANCE SOLUTION TO KEEP WATER PUMPS RUNNING LIKE NEW. DANNER RECOMMENDS CONSUMERS TO USE PUMPGUARD EVERY SIX MONTHS TO INSURE PROPER OPERATION OF THEIR PUMPS.

4 OZ. SUPREME PUMPGUARD • ITEM# 06331

32 OZ. SUPREME PUMPGUARD • ITEM# 06335

- Instantly Loosens Mineral Scale, Lime, Rust and Other Detritus from Aquarium Water Pumps
- Keeps Your Water Pump Operating Properly and Efficiently
- Fast and Easy to Use
- Biodegradable
- Not for use on Aluminum surfaces
- 4 oz. Packed 12 Per Master Carton
32 oz. Packed 6 Per Master Carton

**QUICKLY
CLEANS
CALCIFIED
DIRTY PUMPS
IN MINUTES**



16 OZ. SUPREME AQUA-CLEAN TRIGGER SPRAY ITEM# 06337

32 OZ. SUPREME AQUA-CLEAN TRIGGER SPRAY ITEM# 06339

- Instantly Loosens Mineral Scale, Lime, Rust and other Detritus from Aquarium Pumps, Equipment and Surfaces
- Rapidly Removes Coralline Algae and Dissolves Calcium Carbonate
- Effectively Cleans All of the Surfaces of Your Pumps and Aquarium Equipment
- Safe to use on Glass
- Fast and Easy to Use
- Biodegradable
- 16 oz. Packed 12 Per Master Carton
32 oz. Packed 6 Per Master Carton



SUPREME REPLACEMENT FILTER MEDIA AND IMPELLERS

Supreme AQUARIUM

SUPREME AQUARIUM PRODUCTS have an extensive line of replacement parts carefully designed to maintain the effectiveness of your filter or pump. When the filter media or pump impeller wears out, we always recommend a genuine and original replacement part for ultimate performance.



AIR STONES

4" Air Stone	ITEM# 14640
6" Air Stone	ITEM# 14645
8" Air Stone	ITEM# 14650

AIRLINE TUBING AND CHECK VALVE

16 Foot 5M Airline Tubing	ITEM# 14625
Airline Check Valve	ITEM# 14635

EZ CLEAN REPLACEMENT CARTRIDGES AND MEDIA

Replacement Filter Media Cartridges for use with all EZ Clean Aquarium Filters, 2 Pack	ITEM# 21155
--	-------------

Replacement Filter Media for use with all EZ Clean Aquarium Filters, 2 Pack	ITEM# 21160
---	-------------

EZ CLEAN REPLACEMENT IMPELLERS

EZ Clean External Filter Impeller Assembly	ITEM# 21135
EZ Clean Internal Filter Impeller Assembly	ITEM# 12655

OVATION MEDIA

Ovation 210 Replacement Media	ITEM# 11725
Ovation 380 Replacement Media	ITEM# 11726
Ovation 700 Replacement Media	ITEM# 11727
Ovation 1000 Replacement Media	ITEM# 11728

BIO-MATRIX CARTRIDGES AND MEDIA

Bio-Matrix Cartridge for Skilter, 1 Pack	ITEM# 11802
Bio-Matrix Cartridges, 4 Pack	ITEM# 11804
Bio-Matrix Media Combo, 12 Carbon, 12 Polyester	ITEM# 11812
4x4 Replacement Bio-Matrix Media, 4 Carbon, 4 Polyester	ITEM# 11844
Polyester Bio-Matrix Media, 12 Pack	ITEM# 11866

OVATION IMPELLERS

Ovation 210 Impeller Assembly	ITEM# 11755
Ovation 380 Impeller Assembly	ITEM# 11756
Ovation 700 Impeller Assembly	ITEM# 11757
Ovation 1000 Impeller Assembly	ITEM# 11758

SKILTER IMPELLERS

Skilter 250	ITEM# 11855
Skilter 400	ITEM# 21855

AQUA-MAG WATER PUMP IMPELLERES

Model 2	Impeller Assembly	ITEM# 12555
Model 3, 5	Impeller Assembly	ITEM# 12575
Model 7	Impeller Assembly	ITEM# 12585
Model 9.5 (B)	Impeller Assembly	ITEM# 12746
Model 12 (B)	Impeller Assembly	ITEM# 12756
Model 18 (B)	Impeller Assembly	ITEM# 12776
Model 24 (B)	Impeller Assembly	ITEM# 12791
Model 36 (B)	Impeller Assembly	ITEM# 12796

FRACTIONATING WATER PUMP IMPELLERS

Models 2, 3, 5, 7	Venturi Assembly with Tubing and Muffler	ITEM# 16505
Model 2	Fractionating Impeller Assembly	ITEM# 16555
Model 3, 5	Fractionating Impeller Assembly	ITEM# 16575
Model 7	Fractionating Impeller Assembly	ITEM# 16585
Models 9.5, 12, 18	Venturi Assembly with Tubing and Muffler	ITEM# 16705
Model 9.5	Fractionating Impeller Assembly	ITEM# 16745
Model 12	Fractionating Impeller Assembly	ITEM# 16755
Model 18	Fractionating Impeller Assembly	ITEM# 16775

FOR A COMPLETE LIST OF REPLACEMENT FILTER MEDIA AND IMPELLER ASSEMBLIES VISIT WWW.DANNERMFG.COM

Supreme HYDRO[®]

SUPREME HYDRO-MAG RECIRCULATING WATER PUMPS

SUPREME HYDRO-MAG® 190 to 3600 SERIES PUMPS operate in-line or submerged, with quiet, efficient and reliable 24/7 performance. Models 2 through 18 feature an adjustable venturi which adds aeration into nutrient rich water flow, stimulating root growth and an epoxy encased power unit ensuring that water never gets contaminated with harmful oils or chemicals.

FEATURES

- Models 2 through 18 incorporate an adjustable Venturi which adds Aeration into the nutrient rich water flow, stimulating root growth.
- 10' Power Cord on all models
- Time proven Magnetic Drive Technology
- Energy efficient and Oil-Free
- In-line or Submersible Operation
- Models 2 through 7 Made in USA
- Packed 4 Per Master Carton (1,9)
- Packed 6 Per Master Carton (2, 3, 5 and 7)
- Packed 2 Per Master Carton (9.5, 12, 18, 24 and 36)
- 5 Year Limited Warranty



ADJUSTABLE VENTURI ADDS AERATION



MODEL	ITEM#	Maximum Flow Rate	Watts/Amps	Includes
MODEL 1.9	40120	190 GPH	19/0.3	3/8" MPT Inlet and 1/4" MPT Outlet
MODEL 2 WITH VENTURI	40122	250 GPH	24/0.4	1/2" FPT Inlet and MPT Outlet
MODEL 3 WITH VENTURI	40123	350 GPH	35/0.6	1/2" FPT Inlet and MPT Outlet
MODEL 5 WITH VENTURI	40125	500 GPH	45/0.9	1/2" FPT Inlet and MPT Outlet
MODEL 7 WITH VENTURI	40127	700 GPH	70/1.6	1/2" FPT Inlet and MPT Outlet
MODEL 9.5 WITH VENTURI	40129	950 GPH	93/1.33	3/4" FPT Inlet and MPT Outlet
MODEL 12 WITH VENTURI	40132	1200 GPH	110/1.5	3/4" FPT Inlet and MPT Outlet
MODEL 18 WITH VENTURI	40138	1800 GPH	145/1.55	3/4" FPT Inlet and MPT Outlet
MODEL 24	40140	2400 GPH	237/2.2	1" FPT Inlet and MPT Outlet
MODEL 36	40145	3100 GPH	256/3.0	1" FPT Inlet and MPT Outlet

PUMP	SHUT OFF	FLOOD TABLE SIZES						
		2x2	2x3	2x4	3x3	3x6	4x4	8x4
190 GPH	7'	x						
250 GPH	7'	x	x					
350 GPH	10.5'		x	x				
500 GPH	10.5'			x	x			
700 GPH	11.5'			x	x			
950 GPH	13.5'					x	x	
1200 GPH	13.5'					x	x	x
1800 GPH	16.5'							x
2400 GPH	17'							x
3600 GPH	22.5'							x

Shut off is the maximum vertical height the pump will pump water. To calculate the pressure (psi), multiply the shut off by .454.

SUPREME HY-DRIVE RECIRCULATING WATER PUMPS

Supreme HYDRO®

SUPREME HYDRO HY-DRIVE WATER PUMPS are rugged, powerful and energy-efficient, ideal for use in vertical grow applications. All pumps come with a full set of fittings.

FEATURES

- Powerful, Efficient Hybrid Magnetic/Direct Drive Motor
- Energy-Efficient to Reduce Operating Cost
- Whisper-Quiet Operation
- Oil-Free with no seals to wear out
- Continuous Duty Operation
- 20' Power Cord with Grounded Plug
- In-line and Submersible Operation
- Maximum water temperature for use: 35°C/95F.
- Packed 2 Per Master Carton
- 3 Year Limited Warranty



IDEAL FOR USE IN VERTICAL GROW APPLICATIONS

PUMP	ITEM#	Maximum Flow Rate	Included Fittings
1400 HY-DRIVE PUMP	40405	1400 GPH	(2) 1 1/2" Couplings, (2) 1 1/2" Stepped Barbs and 1 1/2" Swivel Joint Connector
1900 HY-DRIVE PUMP	40415	1900 GPH	(2) 1 1/2" Couplings, (2) 1 1/2" Stepped Barbs and 1 1/2" Swivel Joint Connector
2550 HY-DRIVE PUMP	40425	2550 GPH	(2) 1 1/2" Couplings, (2) 1 1/2" Stepped Barbs and 1 1/2" Swivel Joint Connector

PUMP	ITEM#	Maximum Flow Rate	Included Fittings
5100 HY-DRIVE PUMP	40435	5100 GPH	1 1/2" Coupling, 2" Coupling, 2" to 1 1/2" Reducer, 1 1/2" Stepped Barb, 2" Stepped Barb, 1 1/2" Swivel Joint Connector
6600 HY-DRIVE PUMP	40445	5100 GPH	1 1/2" Coupling, 2" Coupling, 2" to 1 1/2" Reducer, 1 1/2" Stepped Barb, 2" Stepped Barb, 1 1/2" Swivel Joint Connector
7600 HY-DRIVE PUMP	40450	5100 GPH	1 1/2" Coupling, 2" Coupling, 2" to 1 1/2" Reducer, 1 1/2" Stepped Barb, 2" Stepped Barb, 1 1/2" Swivel Joint Connector

GPH PUMP FLOW VS. PUMPING HEIGHT													
PUMP	ITEM#	WATTS	AMPS	1'	3'	5'	7'	10'	15'	20'	25'	30'	SHUTOFF
1400	40405	150	1.3	1350	1250	1150	1100	950	675	350	-	-	22'
1900	40415	93	.78	1710	1325	870	555	-	-	-	-	-	10'
2550	40425	147	1.3	2380	2010	1490	1045	455	-	-	-	-	11.5'
5100	40435	439	3.6	5100	5050	4650	4375	3900	3050	2375	1675	-	30'
6600	40445	593	4.9	6600	6275	5500	4925	4325	3325	2425	1850	550	30.5'
7600	40450	635	5.3	7440	7210	6690	6170	5525	3805	2640	1310	-	27.5'

To achieve maximum flow from the 5100, 6600 or 7600 GPH pumps, a minimum of 2" ID tubing must be used.

HYDRO-AIR® SUBMERSIBLE WATER & AIR PUMP

THE PONDMASTER HYDRO-AIR SUBMERSIBLE WATER & AIR PUMP IS THE ONLY PUMP OF ITS KIND THAT ACTUALLY MARRIES THE FEATURES OF A TRADITIONAL WATER PUMP WITH THOSE OF AN AIR PUMP, ALL IN ONE COMPACT UNIT.

FEATURES

- One Electrical Outlet needed for both Water and Air
- Custom Diffuser disperses a wide band of Air Bubbles
- Ceramic Shaft
- Pumps up to 1400 Gallons per hour
- Aerates Water up to 1,000 Gallons
- Can be used in depths up to 2-Feet
- (2) Pre-Filters Included
- 8 1/4" L x 3 3/4" W x 5 1/2"H without Diffuser (6 1/2" H with Diffuser)
- 18' Grounded Power Cord
- 1 Year Limited Warranty

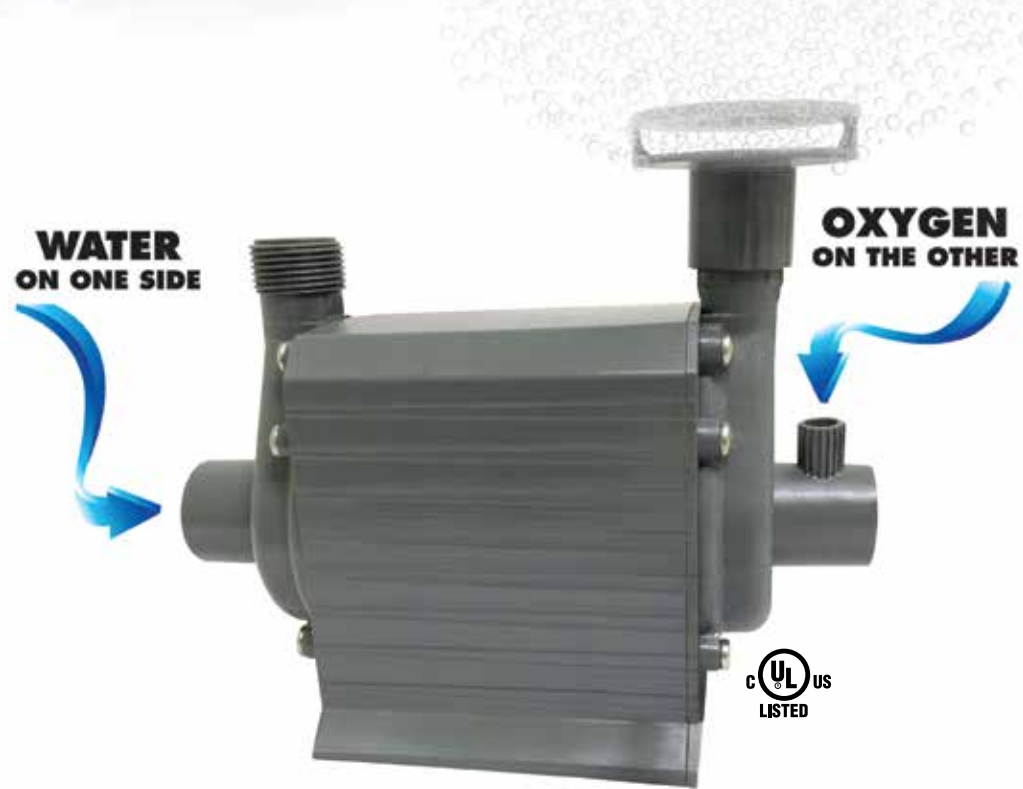

HYDRO-AIR SUBMERSIBLE WATER & AIR PUMP ITEM# 02795

- 17 Ft. Shut-Off with 1-1/2" Tubing
- 16 Ft. Shut-Off with 2" Tubing
- 120 Volts AC, 60 HZ, 199 Watts, 3.7 Amps.

ON WATER PUMP SIDE

- 3/4" FPT Inlet
- 3/4" MPT Outlet

ON AIR PUMP SIDE

- Requires 1/2" Flexible PVC Tubing on the Inlet (sold separately)
- Air Diffuser on the Outlet (included)

PATENTED TECHNOLOGY PROVIDES ALL-IN-ONE CHOICE FOR WATER MOVEMENT AND AERATION

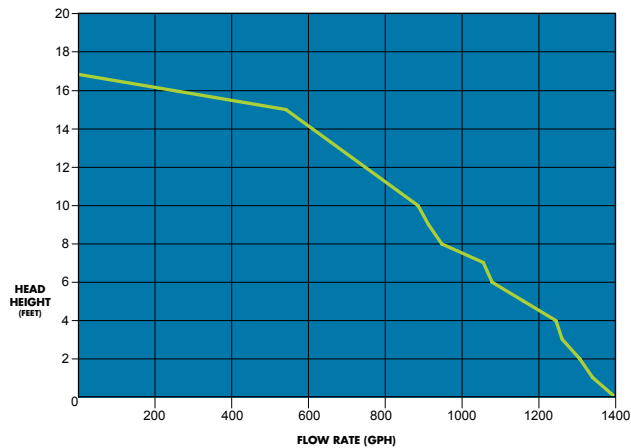

SUBSCRIBE TO OUR YOUTUBE CHANNEL AND VIEW OUR HYDRO-AIR PRODUCT VIDEO!

WWW.YOUTUBE.COM/DANNERMFG

THE GROWER'S PUMP



FEATURES

- Ideal for Ebb & Flow applications
- 70 GPH to 200 GPH Models are designed for Submersible use and 290 GPH to 725 GPH Models can be used Submersible or In-line
- Adjustable Flow Control if used Submersed
- Energy Efficient
- 6' Power Cord
- Oil-Free Design
- Packed 6 Per Master Carton (70, 93, 120 and 200)
Packed 4 Per Master Carton (290, 400, 530 and 725)
- 2 Year Limited Warranty

GREAT FOR EBB AND FLOW APPLICATIONS

70 GPH Pump ITEM# 40303

Maximum Flow	70 GPH
Maximum Pumping Height	2'
Watts/Amps	3/0.3
Includes Slip-Fit Tubing Adapters	1/4" and 1/2"

93 GPH Pump ITEM# 40307

Maximum Flow	93 GPH
Maximum Pumping Height	2.5'
Watts/Amps	6/0.7
Includes Slip-Fit Tubing Adapters	1/4" and 1/2"

120 GPH Pump ITEM# 40313

Maximum Flow	120 GPH
Maximum Pumping Height	3'
Watts/Amps	6.5/0.8
Includes Slip-Fit Tubing Adapters	1/4" and 1/2"

200 GPH Pump ITEM# 40317

Maximum Flow	200 GPH
Maximum Pumping Height	5.6'
Watts/Amps	14/0.19
Includes Slip-Fit Tubing Adapters	1/4" and 1/2"

290 GPH Pump ITEM# 40323

Maximum Flow	290 GPH
Maximum Pumping Height	6.5'
Watts/Amps	17/0.24
Inlet Size	1/2" MPT
Includes Threaded Tubing Adapters	1/2", 5/8" and 3/4"

400 GPH Pump ITEM# 40327

Maximum Flow	400 GPH
Maximum Pumping Height	8.5'
Watts/Amps	30/0.45
Inlet Size	1/2" MPT
Includes Threaded Tubing Adapters	1/2", 5/8" and 3/4"

530 GPH Pump ITEM# 40333

Maximum Flow	530 GPH
Maximum Pumping Height	9'
Watts/Amps	50/0.68
Inlet Size	1/2" MPT
Includes Threaded Tubing Adapters	1/2", 5/8" and 3/4"

725 GPH Pump ITEM# 40337

Maximum Flow	725 GPH
Maximum Pumping Height	12'
Watts/Amps	70/0.50
Inlet Size	1/2" MPT
Includes Threaded Tubing Adapters	1/2", 5/8" and 3/4"



70 GPH Pump



200 GPH Pump



725 GPH Pump Shown with In-Line Volute



PUMP	SHUT OFF	TUBING SIZES						
		2x2	2x3	2x4	3x3	3x6	4x4	8x4
70 GPH	2'	x						
93 GPH	2.5'	x						
120 GPH	3'	x	x					
200 GPH	5.6'	x	x					
290 GPH	6.5'		x	x				
400 GPH	8.5'			x	x			
530 GPH	9'			x	x			
725 GPH	12'				x	x	x	

Shut off is the maximum vertical height the pump will pump water. To calculate the pressure (psi), multiply the shut off by .454.

SUPREME CLONING PUMP WITH SPRAY HEAD

SUPREME CLONING PUMP WITH SPRAY HEAD IS A COMPACT DESIGNED PUMP WITH SPRAY HEAD ATTACHMENT THAT CAN BE USED IN CLONING/ROOTING CUTTINGS. The cloning pump provides a "water spray" keeping the cuttings continually misted for optimum root growth and can spray water 24" - 30" in diameter. The included pump can be used in a 5 gallon bucket system (using one cloning pump) or can be installed in a larger system with multiple pumps.

FEATURES

- Designed Specifically for Plant Cloning
- 24" - 30" Diameter Spray
- Energy Efficient
- Oil-Free
- 6' Power Cord
- Packed 4 Per Master Carton
- 1 Year Limited Warranty

CLONING 155 GPH PUMP WITH TUBE AND SPRAY HEAD

ITEM# 40355

Maximum Flow Rate	155 GPH
Watts	14

REPLACEMENT COVER (Not Shown)

ITEM# 48310

REPLACEMENT PRE-FILTER (Not Shown)

ITEM# 17505



DESIGNED SPECIFICALLY FOR PLANT CLONING



SUPREME DE-WATERING PUMPS

Supreme HYDRO

SUPREME DE-WATERING PUMP is a powerful, durable, oil-free pump that can remove water down to 1/8 of an inch from any medium to large grow tray or nutrient tank. With a maximum flow rate of 1900 GPH and included adapters for a 3/4" garden hose and a 1 1/2" vacuum hose fitting, it can quickly drain down grow systems. It can also quickly remove water from a variety of common and emergency de-watering applications such as flooded basements, rooftops or anywhere that de-watering is a must.

DE-WATERING PUMP • ITEM# 40465

Weight	8 lbs.
Outlet	1" FNPT
Watts	370 Max
Amps	4A Max
Shut Off Height	24'
Max Flow Rate with 3/4" Garden Hose	1400 GPH
Max Flow Rate with 1-1/2" Pool Hose	1900 GPH

FEATURES

- Removes Water to 1/8"
- Easily Attaches to Garden Hose
- Garden Hose Fittings Included
- 25' Cord with Strain Relief
- Sturdy, Integrated Carry Handle
- Completely Submersible
- Removable Screened Inlet
- 1/2 HP Oil-Free Motor with Thermal Protection
- Lightweight
- High Impact Thermoplastic Housing
- Packed 2 Per Master Carton
- Not for Continuous Duty
- For Fresh Water Use Only
- 1 Year Limited Warranty*

REMOVES WATER DOWN TO 1/8 OF AN INCH



Item# 40465 Shown with Outlet Fittings: 1/2" Hose Fitting and 3/4" GHT Fitting (both included)



Item# 40460

300 GPH DE-WATERING PUMP • ITEM# 40460

Weight	2.75 lbs.
Outlet	3/4" Garden Hose Thread (GHT)
Watts	18 Max
Amps	.2A Max
Shut Off Height	6'
Max Flow Rate	300 GPH
Master Carton Quantity	4

*1 Year Limited Warranty does not include external attachments.

Supreme HYDRO DE-WATERING PUMP

POMPE DE DÉSHYDRATATION | BOMBA DE DESAGUE

The 6MSP De-Watering Pump has been engineered to be a powerful, reliable pumping source for a variety of Hydroponic applications.

With a maximum flow rate of 1900 GPH*, it can quickly remove water in a variety of Hydroponic, Aqueponic and Indoor Gardening applications. It comes complete with a 3/4" garden hose fitting and 1-1/2" external adapter fitting.



SUPREME OXY-FLO HIGH VOLUME AIR PUMPS

SUPREME OXY-FLOW HIGH VOLUME AIR PUMPS have been designed to satisfy the requirements of a multitude of water-related applications. The oil-less motor is designed to operate efficiently and save energy.

FEATURES

- Great for Aerating Nutrient Tanks in Deep Water Culture
- Ideal for use in Compost Tea Brewing
- High Volume with Steady Air Flow
- Energy Efficient Motor
- Easy to Use
- Quiet Operation
- No Lubrication Necessary
- Single Outlet Discharge
- Air Manifold (included)
- Accepts Standard 3/16" Airline Tubing (not included)
- Packed 2 Per Master Carton
- 1 Year Limited Warranty

**GREAT FOR
AERATING
NUTRIENT
TANKS IN
DEEP WATER
CULTURE**



AP-20	ITEM# 40522
Air Volume	1700 cu.in/min
Maximum Water Depth	7'
Noise Level	40 dba
Watts	20
Weight	5 lbs
Air Manifold Outlets	6
Pressure	4.0 psi
Liters	28 L/min.
Dimensions (L x W x H)	8 1/2" x 5 1/2" x 6"
Cord Length	6'

Note: Can Accept 5/8" I.D. Tubing to Extend Distance between Air Pump and Manifold

AP-40	ITEM# 40524
Air Volume	2900 cu.in/min
Maximum Water Depth	9.6'
Noise Level	40 dba
Watts	40
Weight	9 lbs
Air Manifold Outlets	12
Pressure	4.85 psi
Liters	47 L/min.
Dimensions (L x W x H)	9 5/8" x 6 5/8" x 7"
Cord Length	6'

Note: Can Accept 3/4" I.D. Tubing to Extend Distance between Air Pump and Manifold

AP-60	ITEM# 40526
Air Volume	5500 cu.in/min
Maximum Water Depth	10'
Noise Level	45 dba
Watts	60
Weight	14 lbs
Air Manifold Outlets	14
Pressure	5.66 psi
Liters	90 L/min.
Dimensions (L x W x H)	10" x 7 1/2" x 8 1/2"
Cord Length	6'

Note: Can Accept 3/4" I.D. Tubing to Extend Distance between Air Pump and Manifold

AP-100	ITEM# 40528
Air Volume	9150 cu.in/min
Maximum Water Depth	11.5'
Noise Level	45 dba
Watts	100
Weight	16.5 lbs
Air Manifold Outlets	33
Pressure	6.53 psi
Liters	150 L/min.
Dimensions (L x W x H)	11 3/4" x 8" x 8 7/8"
Cord Length	6'

Note: Can Accept 3/4" I.D. Tubing to Extend Distance between Air Pump and Manifold

FOR A COMPLETE LIST OF REPLACEMENT DIAPHRAGM KITS AND MANIFOLDS VISIT WWW.DANNERMFG.COM

SUPREME OXY-FLO LOW VOLUME AIR PUMPS

Supreme HYDRO

SUPREME OXY-FLO AIR PUMPS ARE LOW ENERGY PUMPS THAT CAN BE USED FOR AERATING SMALLER NUTRIENT TANKS AND BUCKET SYSTEMS TO HELP STIMULATE ROOT GROWTH.

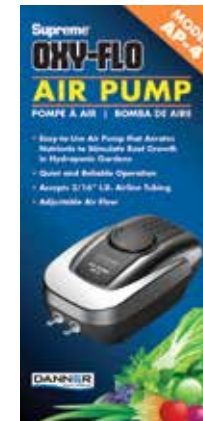

**GREAT FOR
AERATING
SMALLER
NUTRIENT
TANKS AND
BUCKET
SYSTEMS**



FEATURES

- Aerates Nutrients to Stimulate Root Growth
- Great for Aerating smaller Nutrient Tanks and Bucket Systems
- Ideal for use in Compost Tea Brewing
- Energy-Efficient Design
- Easy to Use
- Quiet Operation
- Accepts Standard 3/16" Airline Tubing
- 1 Year Limited Warranty

AP-2	ITEM# 40512
Air Volume	73 cu.in/min
Maximum Water Depth	1.2 L /min
Number of Outlets	1
Watts	1.5
Pressure	0.010 MPa (1.45 psi)
Cord Length	6'

AP-3	ITEM# 40513
Air Volume	110 cu.in/min
Maximum Water Depth	1.8 L /min
Number of Outlets	1
Watts	2.8
Pressure	0.010 MPa (1.45 psi)
Cord Length	6'

AP-4	ITEM# 40514
Air Volume	275 cu.in/min
Maximum Water Depth	4.5 L /min
Number of Outlets	2, Flow Adjustable
Watts	3.5
Pressure	0.014 MPa (2.0 psi)
Cord Length	6'

AP-8	ITEM# 40518
Air Volume	549 cu.in/min
Maximum Water Depth	9 L /min
Number of Outlets	4, Flow Adjustable
Watts	7
Pressure	0.014 MPa (2.0 psi)
Cord Length	6'

FOR A COMPLETE LIST OF REPLACEMENT DIAPHRAGM KITS VISIT WWW.DANNERMFG.COM

SUPREME HYDRO-CLEAN™

SUPREME HYDRO-CLEAN IS AN EASY MAINTENANCE SOLUTION TO KEEP WATER PUMPS RUNNING LIKE NEW. DANNER RECOMMENDS CONSUMERS TO USE HYDRO-CLEAN EVERY SIX MONTHS TO INSURE PROPER OPERATION OF THEIR PUMPS.

FEATURES

- Instantly loosens Mineral Scale, Lime, Rust and other Detritus from Hydroponic Pumps, Equipment, Trays and Surfaces
- Effectively cleans all of the surfaces of your Pumps and Hydroponics equipment
- Fast and easy to use
- Biodegradable
- Not for use on Aluminum surfaces

16 OZ. TRIGGER SPRAY • ITEM# 40775

- Packed 12 Per Master Carton

1 GALLON BOTTLE • ITEM# 40783

- Packed 4 Per Master Carton



**QUICKLY
CLEANS
CALCIFIED
DIRTY PUMPS
IN MINUTES**

BEFORE HYDRO-CLEAN™



AFTER HYDRO-CLEAN™



*Not for use on aluminium, magnesium or Air Stones.

AIR DIFFUSERS

Supreme HYDRO®

AIR DIFFUSERS ARE MADE FROM FLEXIBLE TUBES AND DO A GREAT JOB OF EVENLY DISTRIBUTING BUBBLES INSIDE A HYDROPONIC RESERVOIR. THEY ALSO PUT LESS STRESS ON AIR PUMPS, HELPING THEM LAST LONGER.

6" STRAIGHT AIR DIFFUSER • ITEM# 14570

For Use with AP-20 and AP-40 Air Pumps

7" DIAMETER RING AIR DIFFUSER • ITEM# 14580

For Use with AP-40, AP-60 and AP-100 Air Pumps

- Adapts to 5/8" Tubing
- Includes Nylon Bag to Weight down Diffuser
- Packed 6 Per Master Carton



6" STRAIGHT AIR DIFFUSER WITH TUBING ITEM# 14575

For Use with AP-20 and AP-40 Air Pumps.

- Includes 20' of 5/8" Tubing
- Includes Nylon Bag to Weight down Diffuser
- Packed 1 Per Master Carton



SUPREME EBB & FLOW KIT

THIS PATENTED, INNOVATIVE DESIGN MAKES ADJUSTING THE HEIGHT OF YOUR EBB & FLOW FITTINGS EASIER THAN EVER WHILE BRINGING CONVENIENCE TO YOUR GARDEN. SIMPLY POSITION THE NECK OF THE FILL/ DRAIN SCREENS TO THE DESIRED HEIGHT AND THEN TWIST TO LOCK INTO PLACE. THIS ALLOWS YOU TO EASILY ADJUST THE FILL HEIGHT OF THE WATER IN THE FLOOD TABLE.

**PATENTED
ADJUSTABLE
DESIGN**



EBB AND FLOW KIT • ITEM# 49922

- Includes (2) 2-1/2" and (1) 8" Long Adjustable Fill/Drain Screens
- 1/2" Barbed Fill Fitting
- 3/4" Barbed Drain Fitting
- Packed 6 Per Master Carton



SUBSCRIBE TO OUR YOUTUBE CHANNEL AND VIEW OUR EBB & FLOW PRODUCT VIDEOS!

WWW.YOUTUBE.COM/DANNERMFG

AIR STONES

4" AIR STONE ITEM# 14640

- Fits Standard 3/16" Airline Tubing
- Packed 12 Per Master Carton



6" AIR STONE ITEM# 14645

- Fits Standard 3/16" Airline Tubing
- Packed 12 Per Master Carton



8" AIR STONE ITEM# 14650

- Fits Standard 3/16" Airline Tubing
- Packed 12 Per Master Carton



TUBING AND CHECK VALVES

5M 16' AIRLINE TUBING ITEM# 14625

- Packed 12 Per Master Carton



AIRLINE CHECK VALVE ITEM# 14635

- Packed 12 Per Master Carton



1/2" X 10' STANDARD BLACK TUBING ITEM# 12012

- Packed 6 Per Master Carton



REPLACEMENT PARTS

Supreme HYDRO

Venturi Assembly with Tubing and Muffler for Pump Models 2 to 7	ITEM# 16505
Venturi Assembly with Tubing and Muffler for Pump Models 9.5 to 18	ITEM# 16705
Small Pre-filter for Pump Models 2, 3, 5 and 7	ITEM# 12505
Foam Filter Replacement for Model 1.9 - 2 Pack	ITEM# 12605
Large Pre-filter for Pump Models 2, 3, 5 & 7	ITEM# 12285
Foam Pre-filter for Pump Models 9.5, 12 and 18	ITEM# 12730
Replacement Impeller for 70 GPH Grower's Pump	ITEM# 21705
Replacement Impeller for 93 GPH Grower's Pump	ITEM# 21710
Replacement Impeller for 120 GPH Grower's Pump	ITEM# 21715
Replacement Impeller for 200 GPH Grower's Pump	ITEM# 21720
Replacement Impeller for 290 GPH Grower's Pump	ITEM# 21725
Replacement Impeller for 400 GPH Grower's Pump	ITEM# 21730
Replacement Impeller for 530 GPH Grower's Pump	ITEM# 21735
Replacement Impeller for 725 GPH Grower's Pump	ITEM# 21740
Impeller/Mag for Pump Model 1.9	ITEM# 12955
Impeller/Mag for Pump Model 2	ITEM# 12555
Impeller/Mag for Pump Models 3 and 5	ITEM# 12575
Impeller/Mag for Pump Model 7	ITEM# 12585
Impeller/Mag for Pump Model 9.5 (B)	ITEM# 12746
Impeller/Mag for Pump Model 12 (B)	ITEM# 12756
Impeller/Mag for Pump Model 18 (B)	ITEM# 12776
Impeller/Mag for Pump Model 24 (B)	ITEM# 12791
Impeller/Mag for Pump Model 36 (B)	ITEM# 12796
Impeller/Mag for Hydro-Air™	ITEM# 12972

Fractionating Impeller Assembly for Pump Model 2	ITEM# 16555
Fractionating Impeller Assembly for Pump Models 3 and 5	ITEM# 16575
Fractionating Impeller Assembly for Pump Model 7	ITEM# 16585
Fractionating Impeller Assembly for Pump Model 9.5B	ITEM# 16745
Fractionating Impeller Assembly for Pump Model 12B	ITEM# 16755
Fractionating Impeller Assembly for Pump Model 18B	ITEM# 16775
Replacement Rotor for 1900 HY-Drive Pump	ITEM# 21005
Replacement Rotor for 1400 HY-Drive Pump	ITEM# 21105
Replacement Rotor for 2550 HY-Drive Pump	ITEM# 21110
Replacement Rotor for 5100 HY-Drive Pump	ITEM# 21115
Replacement Rotor for 6600 HY-Drive Pump	ITEM# 21025
Replacement Rotor for 7600 HY-Drive Pump	ITEM# 21120
Replacement Impeller for 300 GPH Utility Pump	ITEM# 21555
Replacement Diaphragm Assembly for AP-4 and AP-8 Air Pumps	ITEM# 14605
Replacement Manifold for AP-20 Air Pump	ITEM# 14505
Replacement Manifold for AP-40 Air Pump	ITEM# 14515
Replacement Manifold for AP-60 Air Pump	ITEM# 14550
Replacement Manifold for AP-100 Air Pump	ITEM# 14560
Diaphragm Kit for AP-20 Air Pump	ITEM# 14525
Diaphragm Kit for AP-40 Air Pump	ITEM# 14545
Diaphragm Kit for AP-60 Air Pump	ITEM# 14555
Diaphragm Kit for AP-100 Air Pump	ITEM# 14565



Air Pump Manifolds



Foam Filters



Replacement Impellers



Fractionating Impellers

FOR A COMPLETE LIST OF REPLACEMENT PARTS VISIT WWW.DANNERMFG.COM



POOL CARE
BY DANNER MANUFACTURING

COVER-CARE MAGNETIC DRIVE POOL COVER PUMPS

COVER-CARE MAGNETIC DRIVE POOL COVER PUMPS MAKES OPENING UP THE BACKYARD POOL EASY WHEN WINTER IS OVER. THEY'RE CLOG RESISTANT AND AVAILABLE IN THREE DIFFERENT PUMPING CAPACITIES TO EASILY ACCOMMODATE VIRTUALLY ANY SIZE SWIMMING POOL COVER.

FEATURES

- Magnetic Drive Motor
- Completely Submersible
- Easily Connects to any Standard 3/4" Garden Hose (Fitting Included)
- 300 GPH: Pumps Down to 1/8" of Water
- 300 GPH: Packed 12 Per Master
- 300 GPH: 1 Year Limited Warranty
- 350 GPH and 500 GPH: Packed 6 Per Master
- 350 GPH and 500 GPH: 5 Year Limited Warranty

CLOG RESISTANT. PERFECT FOR BACKYARD POOL COVERS

300 GPH COVER-CARE POOL COVER PUMP

ITEM# 02540 UPC: 025033025400

Max. Flow Rate	300 GPH
Max. Pumping Height	6'
Cord Length	25'
Max. Watts/Amps	21/0.4
Weight	2.6 lbs.
Dimensions (L x W x H)	5.5" x 4" x 3.75"

350 GPH COVER-CARE POOL COVER PUMP

ITEM# 02533 UPC: 025033025332

Max. Flow Rate	350 GPH
Max. Pumping Height	7'
Cord Length	25'
Max. Watts/Amps	24/0.4
Weight	3.6 lbs.
Dimensions (L x W x H)	5.0" x 3.8" x 4.2"

500 GPH COVER-CARE POOL COVER PUMP

ITEM# 02555 UPC: 025033025554

Max. Flow Rate	500 GPH
Max. Pumping Height	10.5'
Cord Length	25'
Max. Watts/Amps	45/0.9
Weight	3.75 lbs.
Dimensions (L x W x H)	5.0" x 3.8" x 4.2"



02540



02533 | 02555

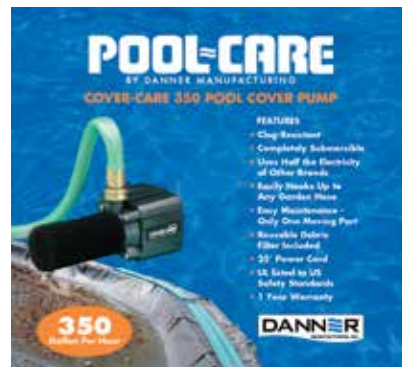

COVER-CARE MAGNETIC DRIVE AUTOMATIC 360 POOL COVER PUMP

POOL-CARE
BY DANNER MANUFACTURING

COVER-CARE MAGNETIC DRIVE AUTOMATIC 360 POOL COVER PUMP makes opening up the backyard pool easy when winter is over. It's clog resistant and can be used on virtually any size pool cover. The Cover-Care Auto 360 Pump detects water levels and pumps down to 1" depth and turns the pump off automatically.

FEATURES

- Electronic Sensor Detects Water Level and Pumps Down to 1" Depth and Turns Pump Off Automatically
- Foam Filter Integrated into Base of Pump
- 360 Gallons Per Hour
- Energy-Efficient Magnetic Drive Technology
- 120V/60Hz/0.7A Thermally Protected
- Connects to Any Standard Garden Hose
- Completely Submersible
- 8' Maximum Pumping Height
- 25' Grounded Power Cord
- 1 Year Limited Warranty

PUMPS DOWN TO 1" DEPTH AND SHUTS OFF AUTOMATICALLY W/ ELECTRONIC SENSOR



COVER-CARE MAGNETIC DRIVE AUTOMATIC 360 POOL COVER PUMP • ITEM# 02531

UPC: 025033025318

Max. Flow Rate	360 GPH
Max. Pumping Height	8'
Cord Length	25'
Max. Watts/Amp	34/0.7
Weight	3.4 lbs.
Dimensions (L x W x H)	6 1/2" x 5 1/2" x 4 3/8"



POOL-CARE MAIN DRAIN UTILITY/POOL PUMP

MAIN DRAIN UTILITY PUMP is designed primarily for draining in-ground swimming pools. The slotted "basket" base measures less than 5 1/2-inches in diameter, which allows the pump to fit inside any standard 8" main drain and seat itself several inches below the top surface of the pool's main drain flange. With a maximum flow rate of 5400 GPH, it can quickly and efficiently remove water from any in-ground Swimming Pool.

FEATURES

- Maximum Flow Rate: 5400 GPH or 90 GPM
- Maximum Head Height: 32-feet
- Pumps Down to 2" water depth
- Fits in standard 8" Pool Main Drain Allowing for Complete Drainage
- Includes 1 1/2" Threaded Barbed Fitting
- Removable Elbow for Vertical or Horizontal Discharge Options
- Integrated Carry Handle
- 25' Cord with Flexible Strain Relief
- Completely Submersible
- Slotted Base Constructed from High Impact ABS
- 316 Marine Grade Stainless Steel Hardware
- Packed 2 per Master Carton
- 1 Year Limited Warranty*

FITS IN STANDARD 8" MAIN DRAIN ALLOWING FOR COMPLETE DRAINAGE



UL LISTED

MAIN DRAIN PUMP • ITEM# 20370

UPC: 025033203709	
Max. Flow Rate	5400 GPH
Max. Pumping Height	32'
Max. Watts/Amps	593/4.9
Weight	12 lbs.
Dimensions w/ Elbow (W x H)	9 3/4" x 15 1/2"
Dimensions w/out Elbow (W x H)	7 1/4" x 15 1/2"

TETHERED FLOAT SWITCH • ITEM# 20375

UPC: 025023203754	
Cord Length:	30' with Piggy Back Plug

Do not run the Pool Main Drain Utility Pump without an automatic shut-off float switch or our available Teathered Float Switch (Item# 20375) for automatic shut-off.

*1 Year Limited Warranty does not include external attachments.



SUBSCRIBE TO OUR YOUTUBE CHANNEL AND VIEW OUR MAIN DRAIN PUMP PRODUCT VIDEOS!

WWW.YOUTUBE.COM/DANNERMFG

POOL-CARE 6MSP UTILITY/POOL PUMP

POOL-CARE
BY DANNER MANUFACTURING

6MSP UTILITY/POOL PUMP is a powerful, durable, oil-free pump that can remove water down to 1/8 of an inch. With a maximum flow rate of 1900 GPH, it can quickly remove water from swimming pools and pool covers. It can also efficiently remove water from a variety of common and emergency de-watering applications such as flooded basements, rooftops or anywhere that de-watering is a must. Fits inside most pool bottoms and 8" main drains and comes complete with adapters for a standard garden hose (3/4") and pool vacuum hose fittings (1 1/2").

FEATURES

- Pumps Down to 1/8"
- Fits In a 8" Main Drain and Most Pool Bottom Drains
- Sturdy, Integrated Carry Handle
- Completely Submersible
- Removable Screened Inlet
- High Impact Thermoplastic Housing
- 1/2 HP Oil-Free Motor with Thermal Protection
- Pool Vacuum & Garden Hose Hose Fittings Included
- 25' Cord with Strain Relief
- Lightweight
- Packed 2 per Master
- 24-Pack Display Pallet
- For Fresh Water Use Only
- Not for Continuous Duty
- 1 Year Limited Warranty*

6MSP UTILITY/POOL PUMP • ITEM# 02585

UPC: 025033025851	
Max. Flow Rate	1900 GPH
Max. Pumping Height	24'
Max. Watts/Amps	370/4
Weight	8 lbs.
Dimensions (L x W x H)	6.5" x 6.5" x 9"



Example of 6MSP Utility/Pool Pump Fitting into a Standard Pool Drain



Optional Teathered Float Switch - Item# 20375 can also be used with 6MSP for automatic shut-off

REMOVES WATER DOWN TO 1/8 OF AN INCH

UL LISTED



6MSP Shown with Outlet Fittings — 1/2" Hose Fitting and 3/4" GHT Fitting



*1 Year Limited Warranty does not include external attachments.

POOL-CARE APP-CONTROLLED MULTI-COLOR LED SPILLWAY

POOL-CARE APP-CONTROLLED MULTI-COLOR LED SPILLWAY for Inground Pools, Retaining Walls and anywhere else you desire the beauty and tranquility of soothing flowing water. Pool-Care App-Controlled Multi-Color LED Spillways are iOS and Android compatible using the Smart Life App, which is available for free within the Apple App Store or Google Play Store. Connect to Smart Life utilizing the Spillway's integrated 2.4 GHz WiFi controller (no secondary hub required) to control the lighting within the LED Spillway, now making your mobile device your remote control. This eliminates the need for a separate remote and the hassle of changing batteries or losing it.

Explore the infinite color possibilities within Smart Life and its adjustable color settings to suit your needs. It features 8 pre-programmed scenes: 4 scenes designed as Night, Reading, Party and Leisure while the other 4 scenes; Soft, Rainbow, Shine and Gorgeous can be adjusted based on your mood. You can also set up multiple schedules to turn the lighting on/off according to your desired preset time.

FEATURES

- App-Controlled LED Spillway compatible w/ iOS and Android devices
- Free 'Smart Life' App available in the Apple App Store or Google Play Store
- Your mobile device is your remote control, Eliminates the need for a separate remote
- Connect w/ the Spillways waterproof 2.4 GHz WiFi controller
- Infinite color possibilities w/ adjustable settings
- Works w/ Voice Control via Amazon Echo, Alexa, Google Home and/or Assistant
- Interior baffling system that produces a single, lighted water sheet
- Reinforced opening with 5" Lip Extension
- Bottom Mount with integrated 1 1/2" Female Threaded Connection
- 43' power cord length w/ rain-proof transformer & waterproof WiFi controller
- Product Dimension: 36" W x 8" D x 4" H
- Recommended pump size: 3600 GPH
- 1 Year Limited Warranty
- Packed 1 per Master Carton

INFINITE COLOR POSSIBILITIES WITH 8 PRE-PROGRAMMED SCENES



POOL-CARE APP-CONTROLLED MULTI-COLOR LED SPILLWAY

POOL-CARE
BY DANNER MANUFACTURING

POOL-CARE APP-CONTROLLED 36" MULTI-COLOR LED SPILLWAY • ITEM# 10703

UPC: 025033107038

Product Dimension: 36" W x 8" D x 4" H



SCAN CODE USING YOUR SMART DEVICE CAMERA. THIS WILL DIRECTLY TAKE YOU TO THE APPLE APP STORE OR GOOGLE PLAY STORE TO DOWNLOAD SMART LIFE FOR FREE.



ALSO WORKS WITH VOICE CONTROL



Smart Life and its logo is a registered trademark of Smart Inc., Apple, App Store and its logos are registered trademarks of Apple Inc., Amazon, Alexa, Echo and its logos are registered trademarks of Amazon.com, Inc., Google Play, Home, Assistant and its logos are registered trademarks of Google LLC. All Rights Reserved.

Home Collection



DANNER HOME COLLECTION MEDITATION FOUNTAINS

THE DANNER HOME COLLECTION LINE OF FOUNTAINS BRING RELAXATION TO A WHOLE NEW LEVEL. FROM SMALL TABLE-TOP FOUNTAINS TO LARGE OUTDOOR FOUNTAINS, THESE DECORATIVE DESIGNS BRING A CALM, ZEN-LIKE FEELING TO ANY HOME OR WORKSPACE.

STYLE

With many options available, these attractive designs will capture attention wherever they're placed.

SOUND

With the sound of peaceful flowing water, unwind and relax whether at home or at work.

LIGHT

LED Lighting illuminates off the cascading water to create a soft reflection to ensure ultimate tranquility.

SIZE

From small table-top fountains to large outdoor fountains, each design offers the ultimate in convenience.

PRESENTATION

Each Resin fountain comes in a beautifully packaged box easy for gift wrapping for a friend or loved one.



SUBSCRIBE TO OUR YOUTUBE CHANNEL AND VIEW ALL OF OUR FOUNTAIN VIDEOS!

WWW.YOUTUBE.COM/DANNERMFG

OUTDOOR/INDOOR WATER FOUNTAINS



The Outdoor/Indoor Water Fountains are stylish pieces of decor that bring a Zen-like tranquility to any home. They feature a durable and versatile design for a natural look with realistic textures for a stylish and soothing addition to your Garden, Patio, Deck, Porch or Backyard. You can even bring them indoors to ensure ultimate relaxation within your home.

EACH FOUNTAIN INCLUDES:

- Outdoor/Indoor Resin Water Fountain
- Water Pump
- Built-in LED Lights
- 6' Power Cord with IP-44 rated rainproof low voltage transformer for use in outdoor environments (Low Voltage Transformer listed to safety regulations: UL or ETL depending on model)
- Packed one per Master Carton



OUTDOOR/INDOOR WATER FOUNTAIN

Item# 03882

UPC: 025033038820

PRODUCT DIMENSION:
13 1/2" W x 11 1/2" D x 29 3/4" H

GIFT BOX DIMENSIONS
• 17" W x 16" D x 32 5/8" H

MASTER CARTON DIMENSIONS
• 17 1/2" W x 16 1/2" D x 33 3/8" H



OUTDOOR/INDOOR WATER FOUNTAIN

Item# 03880

UPC: 025033038806

PRODUCT DIMENSION:
12" W x 9 1/4" D x 18 1/2" H

GIFT BOX DIMENSIONS
• 13 1/2" W x 11 7/8" D x 20 1/4" H

MASTER CARTON DIMENSIONS
• 14" W x 12" D x 20 7/8" H



OUTDOOR/INDOOR WATER FOUNTAIN

Item# 03881

UPC: 025033038813

PRODUCT DIMENSION:
10 1/2" W x 8 1/2" D x 18 3/4" H

GIFT BOX DIMENSIONS
• 12" W x 10" D x 20 1/8" H

MASTER CARTON DIMENSIONS
• 12 1/2" W x 10 1/2" D x 20 7/8" H

PERFECT FOR YOUR GARDEN, PATIO, DECK, PORCH OR BACKYARD.



DANNER HOME COLLECTION MEDITATION FOUNTAINS

The Home Collection line of Meditation Fountains by Danner Manufacturing are stylish pieces of decor that fit on any tabletop, kitchen counter, living room table, bathroom sink, shelf, vanity or office desk while bringing a calm, Zen-like feel to any room in the house or work space.

Turn one on before bedtime and drift off to sleep as you listen to the sound of peaceful running water with its soft glow as a night light. You can even use it while you're meditating, practicing yoga or at the office to center yourself while at work.

EACH MEDITATION FOUNTAINS INCLUDES:

- Resin Tabletop Meditation Fountain
- Fountain base
- Water Pump
- LED Light
- Decorative Stones (Felicity, Adore, Aura & Halo only)
- 6' Power Cord with AC Wall Adapter
(Low Voltage transformer listed to US and Canadian UL standards)
- Each packed 2 Per Master Carton

ENJOY
THE SOOTHING
SOUND OF
FLOWING
WATER



Halo

HALO MEDITATION FOUNTAIN
Item# 03802
UPC: 025033038028
PRODUCT DIMENSION:
8 1/2" W x 7 3/8" D x 11" H



Aura

AURA MEDITATION FOUNTAIN
Item# 03801
UPC: 025033038011
PRODUCT DIMENSION:
8 1/2" W x 7 3/8" D x 10 1/8" H



DANNER HOME COLLECTION MEDITATION FOUNTAINS

DANNER MANUFACTURING, INC. *Home Collection*



Mantra

MANTRA MEDITATION FOUNTAIN
Item# 03850
UPC: 025033038509
PRODUCT DIMENSION:
7 1/2" W x 7 1/2" D x 11 1/2" H



Felicity

FELICITY MEDITATION FOUNTAIN
Item# 03822
UPC: 025033038226
PRODUCT DIMENSION:
8 1/2" W x 7 1/2" D x 11" H

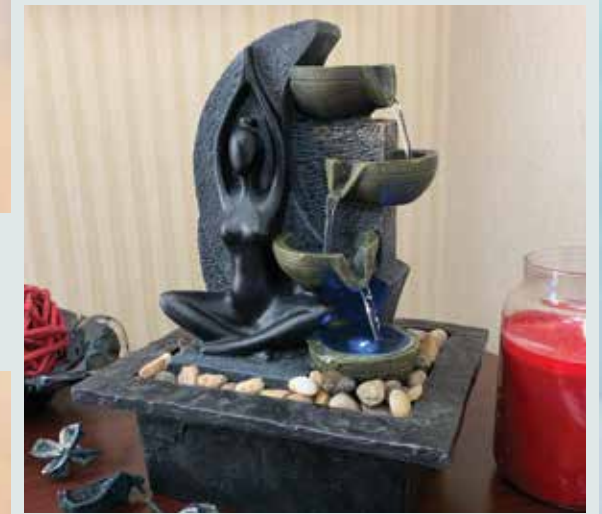

Adore

ADORE MEDITATION FOUNTAIN
Item# 03810
UPC: 025033038103
PRODUCT DIMENSION:
7 7/8" W x 7 7/8" D x 8" H



PERFECT FOR ANY ROOM IN THE HOUSE OR WORK SPACE

ENJOY THE SOOTHING SOUND OF FLOWING WATER

DANNER HOME COLLECTION MEDITATION FOUNTAINS

We are pleased to offer larger Meditation Fountains that conveniently fit on select tabletops, counters, living room tables, shelves, vanities or even your office desk while bringing a calm, Zen-like feel to any room in the house or work space.

You can place the Harmony or Euphoria on the floor in your favorite room as you listen to the sound of peaceful running water with its soft glow as a night light. You can even use it while you're meditating, practicing yoga or at the office to center yourself while at work.

EACH MEDITATION FOUNTAIN INCLUDES:

- Resin Meditation Fountain
- Water Pump
- LED Light
- 6' Power Cord with AC Wall Adapter
(Low Voltage transformer listed to US and Canadian UL standards)
- Packed 1 Per Master Carton

Harmony

HARMONY MEDITATION FOUNTAIN
Item# 03821
UPC: 025033038219
PRODUCT DIMENSION:
8 3/4" W x 9" D x 15 1/2" H

Euphoria

EUPHORIA MEDITATION FOUNTAIN
Item# 03820
UPC: 025033038202
PRODUCT DIMENSION:
11 1/4" W x 9" D x 19" H

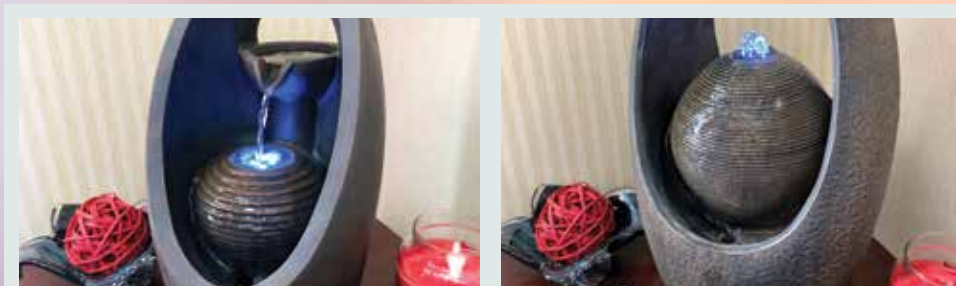

PERFECT FOR ANY ROOM IN THE HOUSE OR WORK SPACE

ENJOY
THE SOOTHING
SOUND OF
FLOWING
WATER

DANNER HOME COLLECTION DAMIEN TABLETOP FOUNTAIN



Damien

The Damien Tabletop Fountain is a stylish yet haunting piece of decor that fits on any tabletop, kitchen counter, living room table, shelf or desk.

The Damien Tabletop Fountain features a rotating 360° glass orb that is moved by the pump's water flow. Just place the glass orb inside Damien's mouth, turn on the fountain and watch as the inside of Damien's skull and eye sockets become illuminated with changing, multi-colors as the orb rotates.

DAMIEN TABLETOP FOUNTAIN
Item# 03875
UPC: 025033038752
PRODUCT DIMENSION
• 8 1/4" W x 8 1/4" D x 10" H

DAMIEN TABLETOP FOUNTAIN INCLUDES:

- Resin Damien Tabletop Fountain
- Fountain base
- Water Pump
- LED Light
- Decorative Stones
- Glass Orb
- 6' Power Cord with AC Wall Adapter
(Low Voltage Transformer listed to UL or ETL safety regulations)
- Packed 2 Per Master Carton



360°
ROTATING 360°
GLASS ORB

DANNER HOME COLLECTION SHELLY TABLETOP FOUNTAIN

The Shelly Tabletop Fountain is a stylish piece of decor that fits on any tabletop, shelf, vanity or desk while bringing a calm, relaxing feel to any room in the house or work space. Teachers can use Shelly in the classroom to help create a calm, learning environment while parents can carefully situate Shelly in the nursery before bedtime and watch as your precious child drifts off to sleep listening to the sound of peaceful running water with its soft glow as a night light.

Shelly also features a rotating 360° glass orb that is moved by the pumps water flow. Just place the glass orb on top of the fountain base and watch as it rotates while it illuminates the multicolor LED light from underneath the water.

CAUTION: This electric product is not intended as toy and adult supervision should be used for both setting it up safely and maintaining water levels when used around small children.

INCLUDES:

- Resin Shelly Tabletop Fountain
- Fountain base
- Water Pump
- LED Light
- Glass Pearl
- 6' Power Cord with AC Wall Adapter (Low Voltage Transformer listed to safety regulations - UL or ETL depending on model)
- Master Carton Quantity: 2



SHELLY TABLETOP FOUNTAIN
Item# 03884
UPC: 025033038844
PRODUCT DIMENSION:
8 1/2" W x 8 1/2" D x 12" H



PERFECT FOR CLASSROOMS TO HELP CREATE A CALM, LEARNING ENVIRONMENT



DANNER HOME COLLECTION CERAMIC PET FOUNTAINS



Pamper your precious cat or small dog by offering healthy, filtered drinking water from the Danner Home Collection line of Ceramic Pet Fountains. Each Ceramic Pet Fountain is specifically designed to deliver crystal clear, cascading water which encourages increased pet hydration, helping to maintain your pet's health. They're also stylish pieces of decor that add ambiance to any room in your home and offers an upgraded alternative to classic water dishes for your pet.



KOI CERAMIC PET FOUNTAIN
Item# 71100
UPC: 025033711006
PRODUCT DIMENSION WITH TOP ON:
9" H x 7" DIAMETER

GIFT BOX DIMENSIONS
• 9" W x 9" D x 8 3/4" H

MASTER CARTON DIMENSIONS
• 9 3/16" W x 9 3/16" D x 9 5/8" H



KITTY CERAMIC PET FOUNTAIN
Item# 71101
UPC: 025033711013
PRODUCT DIMENSION WITH TOP ON:
7 1/4" H x 7" DIAMETER

GIFT BOX DIMENSIONS
• 9" W x 9" D x 8 3/4" H

MASTER CARTON DIMENSIONS
• 9 3/16" W x 9 3/16" D x 9 5/8" H



CUPCAKE CERAMIC PET FOUNTAIN
Item# 71102
UPC: 025033711020
PRODUCT DIMENSION WITH TOP ON:
7 1/2" H x 7" DIAMETER

GIFT BOX DIMENSIONS
• 9" W x 9" D x 8 3/4" H

MASTER CARTON DIMENSIONS
• 9 3/16" W x 9 3/16" D x 9 5/8" H



CASCADE CERAMIC PET FOUNTAIN
Item# 71103
UPC: 025033711037
PRODUCT DIMENSION WITH TOP ON:
7" H x 7" DIAMETER

GIFT BOX DIMENSIONS
• 9" W x 9" D x 8 3/4" H

MASTER CARTON DIMENSIONS
• 9 3/16" W x 9 3/16" D x 9 5/8" H

EACH CERAMIC PET FOUNTAIN INCLUDES:

- Ceramic Fountain Top
- Glazed Ceramic Base: 7" Diameter x 5 1/2" High
- Replaceable 3-Stage Water Filter Cartridge: Reticulated Foam, Polyester & Activated Charcoal
- Water Pump w/ Adjustable Flow Control
- Fitting and Tubing
- USB Plug w/ AC Adapter
- 6' Power Cord (listed to safety regulations - UL or ETL depending on model)

FEATURES:

- Constant recirculation and filtration of water helps eliminate harmful bacterial growth, bad tastes and odors from ordinary tap water, yielding a healthier and happier pet companion
- Specifically designed to deliver crystal clear, cascading water which encourages increased pet hydration, helping to maintain your pet's health.
- 48 gallon per hour (GPH) Pump with Adjustable Flow Control
- Classic glazed ceramic fountain design adds ambiance to any room in your home
- Master Carton Quantity: 1



3-Stage Filter attaches easily to pump. No tools needed.



USB Plug w/ AC Adapter.



DANNER HOME COLLECTION STAINLESS STEEL, ANTI-SKID DOG BOWLS



Home Collection Stainless Steel, Ant-Skid Dog Bowls offer optimal feeding and drinking options for your Dog Companion. The certified, pet-friendly stainless steel design offers a healthy alternative to traditional plastic bowls. An anti-skid, rubber base assures the bowl remains stationary as your pet eats or drinks. Offered in an array of bold color options to compliment any home décor with a scratch resistant, metallic finish. Choose from 8 oz., 24 oz., and 32 oz. options to compliment your pet's size.

FEATURES:

- Pet-Safe Certified
- Stainless Steel Design
- Removable, Anti-Skid Rubber Base
- Scratch Resistant Metallic Finish
- Easy to Clean and Dishwasher Safe
- Multiple color options
- Available in 8 oz., 24 oz., and 32 oz.

8 oz:

- Shipping Carton Dimensions: 9" W x 9" D x 3" H

24 oz:

- Shipping Carton Dimensions: 10" W x 10" D x 3" H

32 oz:

- Shipping Carton Dimensions: 12" W x 12" D x 4" H

*Shipping Carton Dimensions are based on two bowls per Dog Bowl Size within Shipping Carton. No Master Carton quantity minimum.



MIDNIGHT
8 OZ
Item#: 73001
UPC: 025033730014

24 OZ
Item#: 73002
UPC: 025033730021

32 OZ
Item#: 73003
UPC: 025033730038



DARK PEWTER
8 OZ
Item#: 73004
UPC: 025033730045

24 OZ
Item#: 73005
UPC: 025033730052

32 OZ
Item#: 73006
UPC: 025033730069



AMETHYST
8 OZ
Item#: 73007
UPC: 025033730076

24 OZ
Item#: 73008
UPC: 025033730083

32 OZ
Item#: 73009
UPC: 025033730090



SANGRIA
8 OZ
Item#: 73010
UPC: 025033730106

24 OZ
Item#: 73011
UPC: 025033730113

32 OZ
Item#: 73012
UPC: 025033730120



ARUBA BLUE
8 OZ
Item#: 73013
UPC: 025033730137

24 OZ
Item#: 73014
UPC: 025033730144

32 OZ
Item#: 73015
UPC: 025033730151



CRIMSON RED
8 OZ
Item#: 73016
UPC: 025033730168

24 OZ
Item#: 73017
UPC: 025033730175

32 OZ
Item#: 73018
UPC: 025033730182

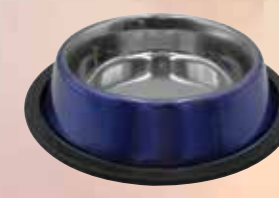

MEZMERIZED BLUE
8 OZ
Item#: 73019
UPC: 025033730199

24 OZ
Item#: 73020
UPC: 025033730205

32 OZ
Item#: 73021
UPC: 025033730212



LILAC
8 OZ
Item#: 73022
UPC: 025033730229

24 OZ
Item#: 73023
UPC: 025033730236

32 OZ
Item#: 73024
UPC: 025033730243



LAVENDER
8 OZ
Item#: 73025
UPC: 025033730250

24 OZ
Item#: 73026
UPC: 025033730267

32 OZ
Item#: 73027
UPC: 025033730274



AUTUMN ORANGE
8 OZ
Item#: 73028
UPC: 025033730281

24 OZ
Item#: 73029
UPC: 025033730298

32 OZ
Item#: 73030
UPC: 025033730304

DANNER HOME COLLECTION PORTABLE PET TRAVEL WATER BOTTLE

Danner Home Collection Portable Pet Travel Water Bottles offer optimal hydration for your pet companion on extended walks, jogs, hikes or any other adventure you wish to share with your furry best friend. Stainless steel construction ensures you're offering cool, pet-friendly drinking water in a convenient design. The Pet-Safe reversible lid is easily removable to become the ideal, leak-free water dish while you are both on the go.



MIDNIGHT BLUE PORTABLE PET TRAVEL WATER BOTTLE
Item# 74001
UPC: 025033740013



INCLUDES:

- 750 mL (25.4 oz) stainless steel water bottle
- Pet-Safe reversible lid becomes the perfect drinking bowl in a leak-free design
- Color coordinated clip which allows for attachment to a backpack, purse or belt

FEATURES:

- Specifically designed, pet-friendly travel water bottle offers fresh, cool drinking water for your pet companion on the go
- Durable, light weight, stainless steel construction has a 750mL (25.4 oz) capacity allowing for optimal pet hydration on extended walks, hikes, adventures and travel of all kinds
- User-friendly travel bottle features an easy to remove, Pet-Safe lid that becomes the perfect drinking bowl in a leak-proof design
- Convenient color coordinated clip allows for easy attachment to a backpack, purse or belt
- Fits in a vehicle's standard cup holder
- Bold color choices available to match the personality of your furry best friend
- Stainless Steel bottle helps to keep water cooler for extended periods of time and is dishwasher safe
- No Master Carton quantity minimum

DIMENSIONS:

PRODUCT DIMENSIONS: 3 1/8" W x 3 1/8" D x 9 1/2" H
GIFT BOX DIMENSIONS: 3 3/8" W x 3 3/8" D x 10 5/8" H



RUBY RED PORTABLE PET TRAVEL WATER BOTTLE
Item# 74002
UPC: 025033740020



CLASSIC SILVER PORTABLE PET TRAVEL WATER BOTTLE
Item# 74003
UPC: 025033740037



DANNER HOME COLLECTION POLARIS INTERACTIVE CAT TOY



Polaris Interactive Cat Toy are perfect for stimulating your cat's curiosity while offering fun playtime sessions. The Polaris spins a full 360-degrees while teasing your cat with its two furry ears. It features a laser light that shines in the direction Polaris is spinning, engaging your cat to exercise while encouraging fun, active play. It also features both a touch sensor and noise sensor that activates Polaris to help stimulate your cat's joyful hunting instincts. Polaris will enter sleep mode after a period of inactivity to save battery life and is available in three color choices to match the personality of your precious cat; white, pink or blue.



POLARIS WHITE INTERACTIVE CAT TOY
Item# 74506
UPC: 025033745063

FEATURES:

- Spins 360 degrees to help promote the physical and mental well-being of your cat
- Laser Light shines in direction its spinning offering fun playtime sessions
- Interactive Touch Sensor and Noise Sensor for automatic turn-on
- Intelligent Sleep Mode after a period of inactivity to save battery life
- Available in three color choices; white, pink or blue
- Requires (3) AA Batteries (not included)
- Safe and healthy for cats. Made of durable plastic material that stands up to cat scratches and antics
- No Master Carton quantity minimum

DIMENSIONS:

PRODUCT DIMENSIONS (With Furry Ears):
4" W x 4 1/4" D x 5 1/4" H
GIFT BOX DIMENSIONS: 4" W x 4" D x 4" H



POLARIS BLUE INTERACTIVE CAT TOY
Item# 74508
UPC: 025033745087



POLARIS PINK INTERACTIVE CAT TOY
Item# 74507
UPC: 025033745070

DANNER HOME COLLECTION CRAZY BUTTERFLY INTERACTIVE CAT TOY

Danner Home Collection Crazy Butterfly Interactive Cat Toy is perfect for stimulating your cat's hunting instincts while offering fun playtime sessions. It features both a touch sensor and noise sensor that activates the Crazy Butterfly while offering insect-like sounds to tease your cat for fun, active play. The butterfly spinning through the air rotates a full 360-degrees while engaging your cat into catching it. The Crazy Butterfly will enter sleep mode after a period of inactivity to save battery life and is available in three color choices to match the personality of your precious cat; white, pink or blue.



FEATURES:

- Interactive Touch Sensor and Noise Sensor for automatic turn-on
- Swinging butterfly teasing bar rotates 360 degrees offering fun playtime sessions
- Insect-like sounds stimulate your cat's hunting instincts
- Moves in different patterns to encourage fun, active play
- Intelligent Sleep Mode after a period of inactivity to save battery life
- Available in three color choices; white, pink or blue
- Requires (2) AA Batteries (not included)
- Safe and healthy for cats. Made of durable plastic material that stands up to cat scratches and antics
- No Master Carton quantity minimum

DIMENSIONS:

PRODUCT DIMENSIONS (With Crazy Butterfly extended):
5" W x 3" D x 9" H

GIFT BOX DIMENSIONS: 5" W x 5" D x 2 3/16" H



CRAZY BUTTERFLY WHITE INTERACTIVE CAT TOY
Item# 74505
UPC: 025033745056



CRAZY BUTTERFLY BLUE INTERACTIVE CAT TOY
Item# 74504
UPC: 025033745049



CRAZY BUTTERFLY PINK INTERACTIVE CAT TOY
Item# 74503
UPC: 025033745032

PERFECT FOR ANY ROOM IN THE HOUSE OR WORK SPACE

DANNER HOME COLLECTION FLOWER POWER INTERACTIVE CAT TOY

Danner Home Collection Flower Power Interactive Cat Toy is perfect for stimulating your cat's hunting instincts while offering fun playtime sessions. The swinging butterfly, rotating color strips & insect-like sounds will help motivate your cat's curiosity. It also features anti-slip grips to help prevent from sliding. The Flower Power Interactive Cat Toy is an excellent way for your cat to exercise while encouraging fun, active play.



FEATURES:

- Swinging butterfly teasing bar and rotating color strips motivate cats curiosity
- Insect-like Sounds stimulate your cat's hunting instincts while offering fun playtime sessions
- Anti-slip grips help prevent from sliding when placed on floor surfaces
- Includes extra butterfly teasing bar for longevity
- Requires (2) AAA Batteries (not included)
- Safe and healthy for cats. Made of durable plastic material that stands up to cat scratches and antics
- No Master Carton quantity minimum



FLOWER POWER INTERACTIVE CAT TOY
Item# 74502
UPC: 025033745025
PRODUCT DIMENSIONS: 10" W x 3" D x 10" H
GIFT BOX DIMENSIONS: 10 1/2" W x 10" D x 4" H

DANNER HOME COLLECTION FROGGO CAT TOY

Danner Home Collection Froggo Cat Toy is two toys in one and is perfect for stimulating your cat while offering fun playtime sessions. The two built-in suction cups stick to any flat, smooth surface including glass, tile, walls, coated wood, windows, tubs or plastic to encourage fun and active play. You can also place Froggo on the floor for even more fun for your friendly feline. Whether hanging on the wall or placed on the floor, the hanging ball toy attached to Froggo will attract your precious cat's attention while the bell inside motivates your cats' curiosity.



FEATURES:

- Two toys in one offering fun playtime sessions
- Built-in suction cups stick to any flat/smooth surfaces
- Includes hanging, rotating ball toy to keep your cat entertained
- Includes additional bell
- Safe and healthy for cats. Made of durable plastic material that stands up to cat scratches and antics
- No Master Carton quantity minimum



FROGGO CAT TOY
Item# 74509
UPC: 025033745094
PRODUCT DIMENSIONS: 8" W x 2" D x 7" H
GIFT BOX DIMENSIONS: 7 1/16" W x 6" D x 2" H



@DANNERMFG | DANNERMFG.COM



160 OVAL DRIVE. ISLANDIA, NY 11749 • 1-800-458-5876

Every effort has been made to assure the information included in this catalog is current and correct at the time of printing. We reserve the right to make product changes without notice and assume no responsibility for typographical errors.

CAT-DANNERFULL REV D 08/22