

onyx  cookware



# CAPSULE COFFEE machine

User Manual



**EN TABLE OF CONTENTS**

Product structure diagram	4
Basic operations	5
Care and maintenance	7
Cautions	8
Security warning	8
Technical specifications	8

**IT SOMMARIO**

Schema del prodotto	24
Operazioni di base	25
Cura e manutenzione	27
Avvertenze	28
Avvisi riguardanti la sicurezza	28
Specifiche tecniche	28

**DK INDHOLDSFORTEGNELSE**

Produktets opbygning	9
Grundlæggende betjening	10
Rengøring og vedligeholdelse	12
Advarsler	13
Sikkerhedsadvarsel	13
Tekniske specifikationer	13

**NL INHOUDSTAFEL**

Structuurschema van het product	29
Algemene bedieningswijze	30
Reiniging en onderhoud	32
Voorzorgsmaatregelen	33
Veiligheidswaarschuwing	33
Technische specificaties	33

**DE INHALTSVERZEICHNIS**

Abbildung des Produktaufbaus	14
Grundlegende Funktionen	15
Pflege und Wartung	17
Vorsichtsmaßnahmen	18
Sicherheitshinweise	18
Technische Daten	18

**SE INNEHÅLLSFÖRTECKNING**

Produktstrukturschema	34
Grundläggande funktioner	35
Vård och underhåll	37
Varningar	38
Säkerhetsvarning	38
Tekniska specifikationer	38

**FR TABLE DES MATIÈRES**

Schéma de la structure du produit	19
Opérations élémentaires	20
Entretien et maintenance	22
Avertissement	23
Avertissement de sécurité	23
Particularités techniques	23

**NO INNHOLDSFORTEGNELSE**

Produktstrukturdiagram	39
Grunnleggende operasjoner	40
Stell og vedlikehold	42
Forsiktig	43
Sikkerhetsadvarsel	43
Tekniske spesifikasjoner	43

# EN PRODUCT STRUCTURE DIAGRAM

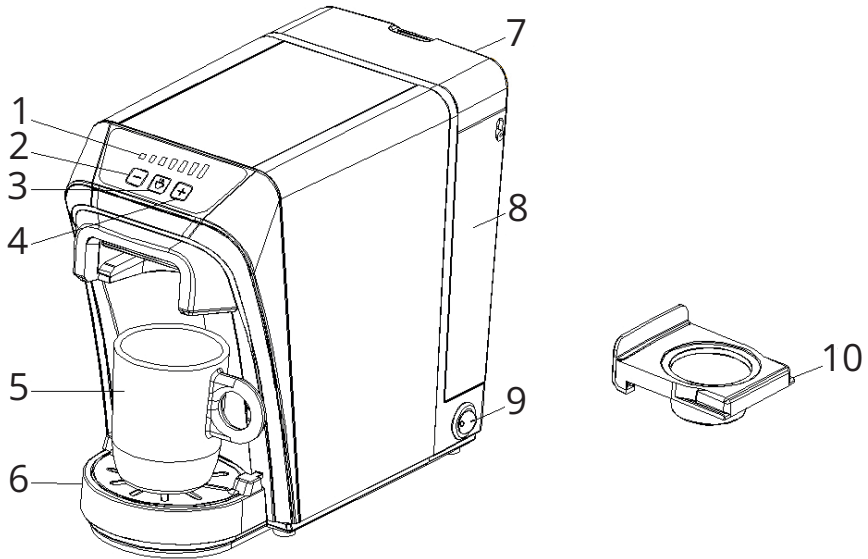







- ① Water amount indicator
- ② MINUS: Reducing water amount
- ③ Start button
- ④ PLUS: Increasing water amount
- ⑤ Cup (Not included)
- ⑥ Drip tray
- ⑦ Lid of water tank
- ⑧ Removable water tank
- ⑨ Power button
- ⑩ Dolce Gusto capsule holder















The drip tray can be adjusted according to the height of the cup.

# EN BASIC OPERATIONS

## BEFORE FIRST USE

-  Remove all the packaging.
-  Clean the capsule holder with hot water, dish soap, and a non-abrasive sponge.
-  Clean the capsule coffee machine with a wet cloth.
-  Place on a heat-resistant, stable, and level surface.
-  Check that all the parts are properly installed and make sure there is no damage on the capsule coffee machine.
-  Fill water into the water tank, place a empty cup on the drip tray, and begin the machine on maximum water amount capacity. First cup is not suggested for drinking.

## HOW IT WORKS:

-  There is a minimum and maximum line indicated on the water tank. Fill enough water into the removable water tank, it shall not exceed the maximum water level (maximum 800ml)
-  Connect the power plug, press the power button to "ON", the indicator light  turns blue and flashes, the capsule coffee machine starts to heat up.
-  Put a cup on the drip tray, adjust the drip tray according to the height of the cup. Make sure that the cup is under the coffee output outlet.
-  Put a capsule into the capsule holder and insert the holder into the brewing chamber.
-  The indicator light will stay on when heating is finished. Adjust the cup capacity according to your needs by pressing the minus/plus button.
-  Press the start button  to start brewing, the  button light will stay on.
-  The indicator light  will stay on after brewing is finished.
-  After a short moment the machine will start brewing. Once the brewing is done, take out the capsule holder and throw the capsule out.



The machine will enter standby mode after brewing. It will automatically turn off if there's no operation within 15 minutes.

# EN BASIC OPERATIONS

## BREWING GUIDE



If the brewing occasionally stops during operations, then press the , and press the button again to restart brewing.



The amount of water needed to brew your capsule coffee, should be written on the package of the capsule brand.

Brewing size	Water output	Dolce Gusto
1	About 50ml	About 30ml
2	About 70ml	About 50ml
3	About 90ml	About 70ml
4	About 120ml	About 100ml
5	About 150ml	About 130ml
6	About 200ml	About 180ml
7	About 260ml	About 240ml

\* The above table is testing data of a certain brand of capsules. The figures can only be used as approximations.

\* The water output refers to the volume of water when there is no capsule placed in the machine.

Dolce Gusto Adapter



Nespresso Adapter















Ground Coffee Adapter



## EN CARE AND MAINTENANCE

- ✓ Unplug the power cable and let the capsule coffee machine cool down before cleaning.
- ✓ Use a clean damp cloth to clean the surface. Do not use any hard objects to clean.
- ✓ Avoid hitting the sharp needle underneath machine's top lid to avoid injury and product malfunction.
- ✓ Take out the drip tray, remove the cover, wash it with soap and water.
- ✓ Clean the water tank occasionally or if you haven't used the capsule coffee machine in a long time.
- ✓ To prevent the milk residue remaining in the capsule holder or brewing chamber to stick, put the Dolce Gusto attachment in the brewing chamber and continue to brew two cups of hot water to clean the holder and chamber.

## DESCALLING

- 1 Fill the water tank with a mixture of clean water and household descaler in a 4:1 ratio. Note that the descaler mixture ratio may vary depending on the brand of descaler used. Please refer to the descalers manufacturer's instructions for the recommended ratio.
- 2 Put a large container on the drip tray, it is suggested to use a container with more than 800 ml capacity.
- 3 Connect the power cable, put any capsule holder (Without capsule) into the brewing chamber.
- 4 The coffee capsule machine should be turned off.
- 5 While the power button is turned off, press and hold button , while holding  turn on the power button. You will see   flash alternately. Let go of  and press the button again. The machine will now enter descaling mode.
- 6 The button  light stays blue and the machine start to pump water from the tank and begin the descaling mode.  
After descaling, pour away the used water from the container, fill at least 600ml of clean water into the water tank.
- 7 When the buttons    light flashes again, press button  and the cleaning procedures will start.
- 8 After cleaning the button    light will stay blue and the machine will return to standby mode.



### NOTE:

Do not use a capsule in the capsule holder when using descaling and cleaning procedures.

## EN CAUTIONS



Please read the manual before using the Capsule coffee machine.



Do not use the coffee machine when the water tank is empty.



Use clean cold water to fill the water tank. Do not use mineral water, milk or other liquids.



Hot air will occur from the coffee machine. Keep at a safe distance.



While coffee brewing is in progress, do not touch the machine directly as the temperature can be very high.



Do not operate or store the coffee machine in any extreme environments.

## SECURITY WARNING



Keep the plug clean and undamaged.



Place the Coffee machine at least 30 cm from the wall or other flammable materials.



Avoid electric shock - don't plug or unplug with wet hands.



Don't use the Coffee machine for other than its intended use.



Keep away from flammable materials.



Keep away from children.



Place the Coffee Machine on a heat-resistant and even surface.



Household Use only.

## TECHNICAL SPECIFICATIONS

- Rated Voltage: 220-240V
- Rated frequency: 50/60Hz
- Rated power: 1400W
- Water tank capacity: 800 ml
- Net Weight: 2,85 Kg

If you have any questions or need help with your coffee machine, please contact [service@onyxcookware.eu](mailto:service@onyxcookware.eu)



### How to get rid of the product again:

This appliance has been identified in accordance with the European directive 2002/96/EG on Waste Electrical and Electronic Equipment - WEEE.



The directive specifies the framework for an EU-wide valid return and recycling of old appliance. Please discard this product at the recycling site.



## DK PRODUKTETS OPBYGNING

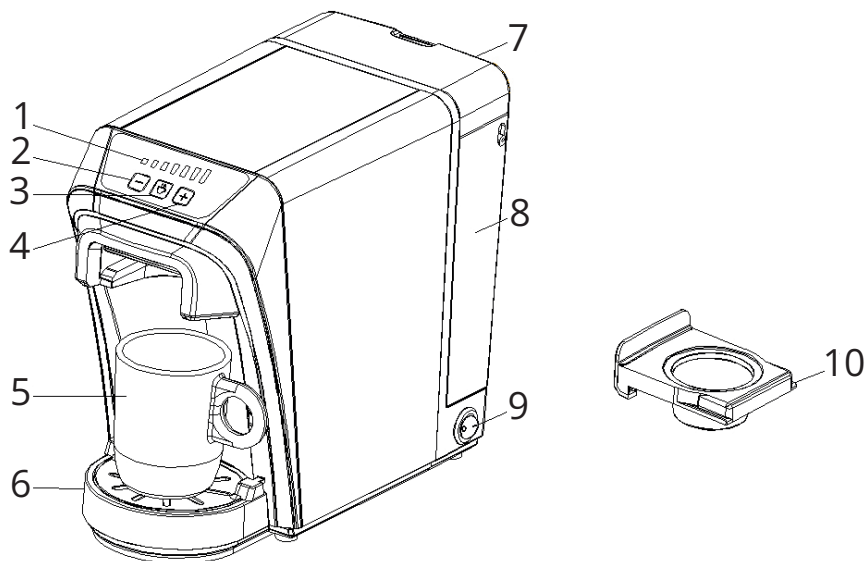

- ① Vandmængdeindikator
- ② MINUS: Reducer vandmængden
- ③ Startknap
- ④ PLUS: Øger vandmængden
- ⑤ Kop (medfølger ikke)
- ⑥ Drypbakke
- ⑦ Låg til vandtank
- ⑧ Aftagelig vandtank
- ⑨ Tænd/sluk-knap
- ⑩ Dolce Gusto kapselholder

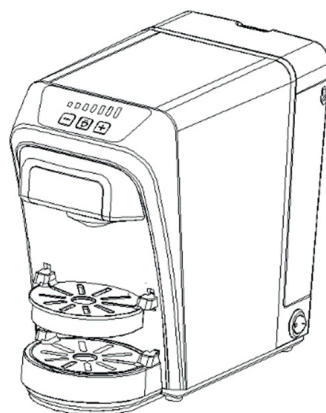









Drypbakken kan justeres efter kopperens højde.

# DK GRUNDLÆGGENDE BETJENING

## INDEN FØRSTE BRUG

- ✓ Fjern al emballagen.
- ✓ Rengør kapselholderen med varmt vand, opvaskemiddel, og en blød svamp.
- ✓ Rengør kaffemaskinen med en våd klud.
- ✓ Placer på en varmebestandig, stabil og jævn overflade.
- ✓ Kontroller, at alle dele er korrekt installeret, og sørg for, at der ikke er skader på kapselkaffemaskinen.
- ✓ Fyld vand i vandtanken, placér en tom kop på drypbakken, og start maskinen med den maksimale vandkapacitet. Den første kop anbefales ikke til drikning.

## SÅDAN VIRKER DET:

- 1 Der er en minimums- og maksimumslinje angivet på vandtanken. Fyld nok vand i den aftagelige vandtank, den må ikke overskride det maksimale vandniveau (maksimum 800 ml)
- 2 Tilslut strømstikket, tryk på tænd/sluk-knappen til "ON", indikatorlyset    bliver blåt og blinker, kapselkaffemaskinen begynder at varme op.
- 3 Sæt en kop på drypbakken, juster drypbakken efter koppenes højde. Sørg for, at koppen er under kaffens udgangsåbning.
- 4 Indsæt en kapsel i kapselholderen og sæt holderen ind i bryggekompartimentet. Indikatorlyset vil lyse konstant, når opvarmningen er færdig. Juster kopstørrelsen efter dit behov ved at trykke på minus/plus-knappen.
- 5 Tryk på startknappen  for at starte brygningen,  knaplyset vil forblive tændt.
- 6 Indikatorlyset    vil forblive tændt efter brygningen er færdig.
- 7 Efter et kort øjeblik vil maskinen begynde at brygge. Når brygningen er færdig, fjernes kapselholderen, og kapslen kastes ud.

Maskinen vil gå i standby-tilstand efter brygning. Den slukker automatisk, hvis der ikke er nogen betjening inden for 15 minutter.

# DK GRUNDLÆGGENDE BETJENING

## BRYGNINGSGUIDE

✓ Hvis brygningen lejlighedsvis stopper under operationer, skal du trykke på , og trykke på knappen igen for at genstarte brygningen.

✓ Mængden af vand, der er nødvendig for at brygge din kapselkaffe, skal være skrevet på pakken fra kapselmærket.

Bryggestørrelse	Vandudgang	Dolce Gusto
1	Cirka 50ml	Cirka 30ml
2	Cirka 70ml	Cirka 50ml
3	Cirka 90ml	Cirka 70ml
4	Cirka 120ml	Cirka 100ml
5	Cirka 150ml	Cirka 130ml
6	Cirka 200ml	Cirka 180ml
7	Cirka 260ml	Cirka 240ml

\* Ovenstående tabel er testdata fra et bestemt mærke af kapsler. Tallene kan kun bruges som omtrentlige værdier.

\* Vandudgang refererer til vandmængden, når der ikke er placeret en kapsel i maskinen.

Dolce Gusto Adapter



Nespresso Adapter











Formalet Kaffe Adapter



## DK RENGØRING OG VEDLIGEHOLDELSE

- ✓ Træk strømkablet ud og lad kapselkaffemaskinen køle ned før rengøring.
- ✓ Brug en ren fugtig klud til at rengøre overfladen. Brug ikke nogen hårde genstande til at rengøre.
- ✓ Undgå at ramme den skarpe nål under maskinens øverste låg for at undgå skade og produktfejl.
- ✓ Tag drypbakken ud, fjern låget, vask det med sæbe og vand.
- ✓ Rengør vandtanken lejlighedsvis, eller hvis du ikke har brugt kapselkaffemaskinen i lang tid.
- ✓ For at forhindre at mælkeresterne forbliver i kapselholderen eller bryggekommeret, sæt Dolce Gusto-vedhæftet filen i bryggekommeret og fortsæt med at brygge to kopper varmt vand for at rengøre holderen og kammeret.

## AFKALKNING

- 1 Fyld vandtanken med en blanding af rent vand og husholdningsafkalker i et forhold på 4:1. Bemærk, at afkalkerblandingsforholdet kan variere afhængigt af afkalkermærket, der anvendes. Se venligst afkalkerproducentens instruktioner for det anbefalede forhold.
- 2 Sæt en stor beholder på drypbakken, det anbefales at bruge en beholder med mere end 800 ml kapacitet.
- 3 Tilslut strømkablet, sæt enhver kapselholder (uden kapsel) i bryggekommeret.
- 4 Kaffekapselmaskinen skal være slukket.
- 5 Mens tænd/sluk-knappen er slukket, skal du trykke og holde knappen , mens du holder  tændt for strømknappen. Du vil se  blinker skiftevis. Slip  og tryk på knappen igen. Maskinen vil nu gå ind i afkalkningstilstand.
- 6 Knappen  lys forbliver blå, og maskinen begynder at pumpe vand fra tanken og begynder afkalkningstilstand.
- 7 Efter afkalkning, hæld det brugte vand ud fra beholderen, fyld mindst 600ml rent vand i vandtanken. Når knapperne  lys blinker igen, tryk på knappen  og rengøringsprocedurerne vil starte.
- 8 Efter rengøring vil knappen  lys forblive blå, og maskinen vil vende tilbage til standby-tilstand.

### BEMÆRK:

Brug ikke en kapsel i kapselholderen, når du bruger afkalknings- og rengøringsprocedurer.



Læs venligst manualen før brug af kapselkaffemaskinen.



Brug ikke kaffemaskinen, når vandtanken er tom.



Brug rent koldt vand til at fylde vandtanken. Brug ikke mineralvand, mælk eller andre væsker.



Varm luft vil opstå fra kaffemaskinen. Hold en sikker afstand.



Mens kaffebrøgning er i gang, skal du ikke røre maskinen direkte, da temperaturen kan være meget høj.



Betjen eller opbevar ikke kaffemaskinen i ekstreme miljøer.

## SIKKERHEDSADVARSEL



Hold stikket rent og ubeskadiget.



Placer kaffemaskinen mindst 30 cm fra væggen eller andre brændbare materialer.



Undgå elektrisk stød - plug ikke ind eller ud med våde hænder.



Brug ikke kaffemaskinen til andet end dens tilsigtede brug.



Hold væk fra brændbare materialer.



Hold væk fra børn.



Placer kaffemaskinen på en varmebestandig og jævn overflade.



Kun til husholdningsbrug.

## TEKNISKE SPECIFIKATIONER

- Nominel spænding: 220-240V
- Nominel frekvens: 50/60Hz
- Nominel effekt: 1400W
- Vandtankkapacitet: 800 ml
- Netto vægt: 2,85 Kg

Hvis du har spørgsmål eller har brug for hjælp med din kaffemaskine, bedes du kontakte [service@onyxcookware.dk](mailto:service@onyxcookware.dk)



### Når du skal skille dig af med produktet igen:



Dette apparat er identificeret i henhold til det europæiske direktiv angående affald af elektrisk og elektronisk udstyr (Waste Electrical and Electronic Equipment) – WEEE.



Hvilket betyder at apparatet kan være til fare for miljøet og menneskers sundhed. Bortskaf venligst dette produkt på offentlige genbrugspladser.

# DE ABBILDUNG DES PRODUKTAUFBAUS

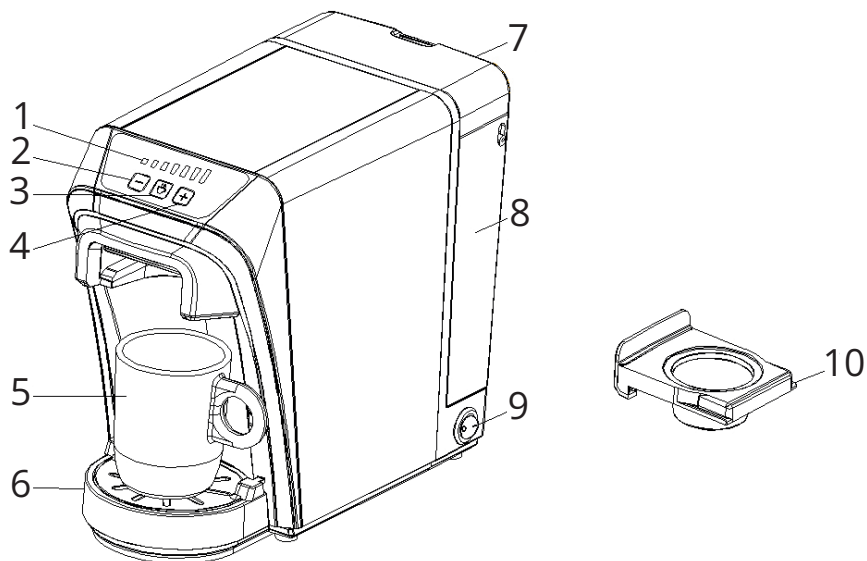

- ① Wasserstandsanzeiger
- ② MINUS: Verringern der Wassermenge
- ③ Startknopf
- ④ PLUS: Erhöhen der Wassermenge
- ⑤ Tasse (nicht enthalten)
- ⑥ Tropfschale
- ⑦ Deckel des Wassertanks
- ⑧ Herausnehmbarer Wassertank
- ⑨ Ein-/Aus-Schalter
- ⑩ Dolce Gusto Kapselhalter

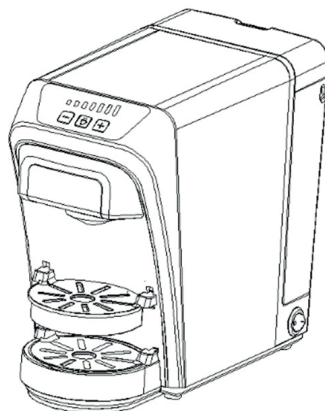









Die Tropfschale kann entsprechend der Höhe der Tasse eingestellt werden.

# DE GRUNDLEGENDE FUNKTIONEN

## VOR ERSTEM GEBRAUCH

- ✓ Entfernen Sie alle Verpackungen.
- ✓ Reinigen Sie den Kapselhalter mit heißem Wasser, Spülmittel und einem nicht scheuern Schwamm.
- ✓ Reinigen Sie die Kapsel-Kaffeemaschine mit einem feuchten Tuch.
- ✓ Stellen Sie die Maschine auf eine hitzebeständige, stabile und ebene Fläche.
- ✓ Prüfen Sie, ob alle Teile richtig installiert sind und ob die Kapsel-Kaffeemaschine keine Schäden aufweist.
- ✓ Füllen Sie Wasser in den Wassertank, stellen Sie eine leere Tasse auf die Tropfschale und starten Sie die Maschine mit der maximalen Wassermenge. Die erste Tasse wird nicht zum Trinken empfohlen.

## SO FUNKTIONIERT ES:

- 1 Am Wassertank sind eine Mindest- und eine Höchstgrenze angegeben. Füllen Sie ausreichend Wasser in den herausnehmbaren Wassertank, es darf die maximale Wasserstandsmarke (maximal 800 ml) nicht überschreiten.
- 2 Schließen Sie den Netzstecker an, drücken Sie den Ein-/Aus-Schalter auf "ON", die Anzeileuchte    leuchtet blau und blinkt, die Kapsel-Kaffeemaschine beginnt sich aufzuheizen.
- 3 Stellen Sie eine Tasse auf die Tropfschale, passen Sie die Tropfschale an die Höhe der Tasse an. Stellen Sie sicher, dass die Tasse unter dem Kaffeeauslass ist.
- 4 Legen Sie eine Kapsel in den Kapselhalter und setzen Sie den Halter in die Brühkammer ein. Die Anzeileuchte bleibt leuchten, wenn das Aufheizen abgeschlossen ist. Passen Sie die Fassengröße entsprechend Ihren Bedürfnissen an, indem Sie die Minus/Plus-Taste drücken.
- 5 Drücken Sie die Starttaste , um das Brühen zu starten, das -Licht der Taste bleibt an.
- 6 Die Anzeileuchte    bleibt nach Beendigung des Brühvorgangs an.
- 7 Nach einem kurzen Moment beginnt die Maschine mit dem Brühen. Sobald das Brühen abgeschlossen ist, nehmen Sie den Kapselhalter heraus und werfen Sie die Kapsel weg.

Die Maschine geht nach dem Brühen in den Standby-Modus. Sie schaltet sich automatisch ab, wenn innerhalb von 15 Minuten keine Bedienung erfolgt.

# DE GRUNDLEGENDE FUNKTIONEN

## BRÜHANLEITUNG



Wenn das Brühen gelegentlich während des Betriebs stoppt, dann drücken Sie die , und drücken Sie die Taste erneut, um das Brühen neu zu starten.



Die benötigte Wassermenge zum Brühen Ihres Kapselkaffees sollte auf der Verpackung der Kapselmarke angegeben sein.

Brühgröße	Wasserausstoß	Dolce Gusto
1	Ungefähr 50ml	Ungefähr 30ml
2	Ungefähr 70ml	Ungefähr 50ml
3	Ungefähr 90ml	Ungefähr 70ml
4	Ungefähr 120ml	Ungefähr 100ml
5	Ungefähr 150ml	Ungefähr 130ml
6	Ungefähr 200ml	Ungefähr 180ml
7	Ungefähr 260ml	Ungefähr 240ml

\* Die obige Tabelle ist Testdaten einer bestimmten Kapselmarke. Die Zahlen können nur als Annäherungswerte verwendet werden.

\* Der Wasserausstoß bezieht sich auf das Volumen des Wassers, wenn keine Kapsel in der Maschine platziert ist.

Dolce Gusto Adapter









Nespresso Adapter

























Kaffeepulver Adapter





-  Ziehen Sie das Netzkabel ab und lassen Sie die Kapsel-Kaffeemaschine vor der Reinigung abkühlen.
-  Reinigen Sie die Oberfläche mit einem sauberen, feuchten Tuch. Verwenden Sie keine harten Gegenstände zum Reinigen.
-  Vermeiden Sie es, die scharfe Nadel unter dem Deckel der Maschine zu treffen, um Verletzungen und Produktfehlfunktionen zu vermeiden.
-  Nehmen Sie die Tropfschale heraus, entfernen Sie die Abdeckung, waschen Sie sie mit Seife und Wasser.
-  Reinigen Sie den Wassertank gelegentlich oder wenn Sie die Kapsel-Kaffeemaschine längere Zeit nicht benutzt haben.
-  Um zu verhindern, dass Milchreste im Kapselhalter oder in der Brühkammer kleben bleiben, setzen Sie den Dolce Gusto Aufsatz in die Brühkammer und brühen Sie zwei Tassen heißes Wasser, um den Halter und die Kammer zu reinigen.

## ENTKALKEN

-  Füllen Sie den Wassertank mit einer Mischung aus sauberem Wasser und Haushaltsentkalker im Verhältnis 4:1. Beachten Sie, dass das Mischungsverhältnis des Entkalkers je nach Marke variieren kann. Bitte beachten Sie die Herstelleranweisungen des Entkalkers für das empfohlene Verhältnis.
-  Stellen Sie einen großen Behälter auf die Tropfschale, es wird empfohlen, einen Behälter mit mehr als 800 ml Fassungsvermögen zu verwenden.
-  Schließen Sie das Netzkabel an, setzen Sie einen Kapselhalter (ohne Kapsel) in die Brühkammer.
-  Die Kaffeekapselmaschine sollte ausgeschaltet sein.
-  Während der Ein-/Aus-Schalter ausgeschaltet ist, drücken und halten Sie die Taste , während Sie die Taste  gedrückt halten, schalten Sie den Ein-/Aus-Schalter ein. Sie werden sehen, dass    abwechselnd blinkt. Lassen Sie  los und drücken Sie die Taste erneut. Die Maschine wird nun in den Entkalkungsmodus wechseln.
-  Die Taste  leuchtet blau und die Maschine beginnt, Wasser aus dem Tank zu pumpen und den Entkalkungsmodus zu starten.
-  Nach dem Entkalken gießen Sie das gebrauchte Wasser aus dem Behälter, füllen Sie mindestens 600 ml sauberes Wasser in den Wassertank. Wenn das Licht der Tasten    wieder blinkt, drücken Sie die Taste  und der Reinigungsvorgang beginnt.
-  Nach der Reinigung bleibt das Licht der Taste    blau und die Maschine kehrt in den Standby-Modus zurück.

### HINWEIS:

Verwenden Sie keine Kapsel im Kapselhalter, wenn Sie Entkalkungs- und Reinigungsverfahren durchführen.

# DE VORSICHTSMAßNAHMEN



Bitte lesen Sie die Bedienungsanleitung vor der Verwendung der Kapsel-Kaffeemaschine.



Verwenden Sie die Kaffeemaschine nicht, wenn der Wassertank leer ist.



Füllen Sie den Wassertank mit sauberem, kaltem Wasser. Verwenden Sie kein Mineralwasser, Milch oder andere Flüssigkeiten.



Heiße Luft tritt aus der Kaffeemaschine aus. Halten Sie einen sicheren Abstand ein.



Berühren Sie die Maschine während des Kaffeebrühens nicht direkt, da die Temperatur sehr hoch sein kann.



Betreiben oder lagern Sie die Kaffeemaschine nicht in extremen Umgebungen.

## SICHERHEITSHINWEISE



Halten Sie den Stecker sauber und unbeschädigt.



Stellen Sie die Kaffeemaschine mindestens 30 cm von der Wand oder anderen brennbaren Materialien entfernt auf.



Vermeiden Sie elektrischen Schlag - stecken Sie nicht ein oder aus mit nassen Händen.



Verwenden Sie die Kaffeemaschine nicht für andere als den vorgesehenen Zweck.



Halten Sie sich von brennbaren Materialien fern.



Halten Sie Kinder fern.



Stellen Sie die Kaffeemaschine auf eine hitzebeständige und ebene Fläche.



Nur für den Haushaltsgebrauch.

## TECHNISCHE DATEN

- Nennspannung: 220-240V
- Nennfrequenz: 50/60Hz
- Nennleistung: 1400W
- Wassertankkapazität: 800 ml
- Nettogewicht: 2,85 Kg

Wenn Sie Fragen haben oder Hilfe bei Ihrer Kaffeemaschine benötigen, wenden Sie sich bitte an [service@onyxcookware.de](mailto:service@onyxcookware.de)



### So entsorgen Sie das Gerät:

Dieses Gerät wurde gemäß der europäischen Richtlinie über Elektro- und Elektronik- Altgeräte (WEEE) gekennzeichnet.



Das bedeutet, dass das Gerät eine Gefahr für die Umwelt und die Gesundheit von Menschen darstellen kann, da es gefährliche Substanzen enthält. Bitte entsorgen Sie dieses Produkt an der öffentlichen Recyclingstelle.



# FR SCHÉMA DE LA STRUCTURE DU PRODUIT

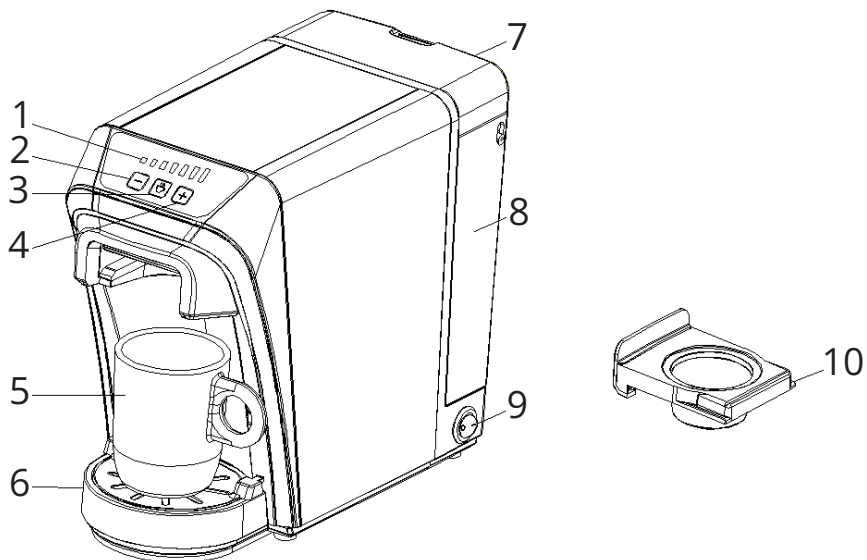

- ① Indicateur de quantité d'eau
- ② MOINS: Réduire la quantité d'eau
- ③ Bouton de démarrage
- ④ PLUS: Augmenter la quantité d'eau
- ⑤ Tasse (Non inclus)
- ⑥ Plateau d'égouttement
- ⑦ Couvercle du réservoir d'eau
- ⑧ Réservoir d'eau amovible
- ⑨ Bouton d'alimentation
- ⑩ Porte-capsule Dolce Gusto

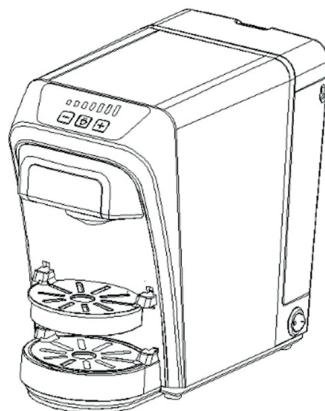









Le plateau d'égouttement peut être ajusté en fonction de la hauteur de la tasse.

## AVANT LA PREMIÈRE UTILISATION

- ✓ Retirez tout l'emballage.
- ✓ Nettoyez le porte-capsule avec de l'eau chaude, du savon à vaisselle et une éponge non abrasive.
- ✓ Nettoyez la machine à café à capsule avec un chiffon humide.
- ✓ Placez sur une surface résistante à la chaleur, stable et de niveau.
- ✓ Vérifiez que toutes les pièces sont correctement installées et assurez-vous qu'il n'y a pas de dommages sur la machine à café à capsule.
- ✓ Remplissez le réservoir d'eau, placez une tasse vide sur le plateau d'égouttement, et mettez la machine en marche à sa capacité maximale en eau. La première tasse n'est pas recommandée pour la consommation.

## COMMENT ÇA MARCHE :

- 1 Il y a une ligne minimum et maximum indiquée sur le réservoir d'eau. Remplissez suffisamment d'eau dans le réservoir d'eau amovible, il ne doit pas dépasser le niveau d'eau maximum (maximum 800ml)
- 2 Branchez le cordon d'alimentation, appuyez sur le bouton d'alimentation pour le mettre sur "ON", le voyant    devient bleu et clignote, la machine à café à capsule commence à chauffer.
- 3 Mettez une tasse sur le plateau d'égouttement, ajustez le plateau d'égouttement en fonction de la hauteur de la tasse. Assurez-vous que la tasse est sous la sortie de café.
- 4 Mettez une capsule dans le porte-capsule et insérez le porte-capsule dans la chambre de brassage. Le voyant restera allumé lorsque le chauffage sera terminé. Ajustez la capacité de la tasse en fonction de vos besoins en appuyant sur le bouton moins/plus.
- 5 Appuyez sur le bouton de démarrage  pour commencer le brassage, le voyant du bouton  restera allumé.
- 6 Le voyant    restera allumé après la fin du brassage.
- 7 Après un court moment, la machine commencera à brasser. Une fois le brassage terminé, sortez le porte-capsule et jetez la capsule.

La machine entrera en mode veille après le brassage. Elle s'éteindra automatiquement s'il n'y a pas d'opération dans les 15 minutes.

# FR OPÉRATIONS ÉLÉMENTAIRES

## GUIDE DE BRASSAGE



Si le brassage s'arrête occasionnellement pendant le fonctionnement, appuyez sur , puis appuyez à nouveau sur le bouton pour redémarrer le brassage.



La quantité d'eau nécessaire pour préparer votre café en capsule doit être indiquée sur l'emballage de la marque de la capsule.

Taille de l'infusion	Sortie d'eau	Dolce Gusto
1	Environ 50ml	Environ 30ml
2	Environ 70ml	Environ 50ml
3	Environ 90ml	Environ 70ml
4	Environ 120ml	Environ 100ml
5	Environ 150ml	Environ 130ml
6	Environ 200ml	Environ 180ml
7	Environ 260ml	Environ 240ml

\* Le tableau ci-dessus est une donnée de test d'une certaine marque de capsules. Les chiffres ne peuvent être utilisés qu'à titre approximatif.

\* La sortie d'eau se réfère au volume d'eau lorsqu'il n'y a pas de capsule placée dans la machine.

Adaptateur Dolce Gusto



Adaptateur Nespresso



Adaptateur pour café moulu





Débranchez le câble d'alimentation et laissez la machine à café à capsule refroidir avant de la nettoyer.



Utilisez un chiffon propre et humide pour nettoyer la surface. N'utilisez pas d'objets durs pour nettoyer.



Évitez de toucher l'aiguille pointue sous le couvercle supérieur de la machine pour éviter les blessures et les dysfonctionnements du produit.



Retirez le plateau d'égouttement, retirez le couvercle, lavez-le avec du savon et de l'eau.



Nettoyez le réservoir d'eau de temps en temps ou si vous n'avez pas utilisé la machine à café à capsule pendant longtemps.



Pour éviter que les résidus de lait restant dans le porte-capsule ou la chambre de brassage ne collent, placez l'accessoire Dolce Gusto dans la chambre de brassage et continuez à brasser deux tasses d'eau chaude pour nettoyer le porte-capsule et la chambre.

## DÉTARTRAGE

1

Remplissez le réservoir d'eau avec un mélange d'eau propre et de détartrant domestique dans une proportion de 4:1. Notez que le ratio du mélange de détartrant peut varier en fonction de la marque du détartrant utilisé. Veuillez vous référer aux instructions du fabricant du détartrant pour le ratio recommandé.

2

Placez un grand récipient sur le plateau d'égouttement, il est suggéré d'utiliser un récipient avec une capacité de plus de 800 ml.







3

Branchez le câble d'alimentation, mettez un porte-capsule (Sans capsule) dans la chambre de brassage.

4

La machine à café à capsule doit être éteinte.





5

Pendant que le bouton d'alimentation est éteint, appuyez et maintenez le bouton  , tout en maintenant  allumez le bouton d'alimentation. Vous verrez    clignoter alternativement. Lâchez  et appuyez à nouveau sur le bouton. La machine entrera alors en mode détartrage.



6

Le bouton  reste bleu et la machine commence à pomper l'eau du réservoir et démarre le mode détartrage.

7

Après le détartrage, jetez l'eau usée du récipient, remplissez au moins 600ml d'eau propre dans le réservoir d'eau. Lorsque les boutons    clignotent à nouveau, appuyez sur le bouton  et les procédures de nettoyage commenceront.

8

Après le nettoyage, le voyant du bouton    restera bleu et la machine retournera en mode veille.

### NOTE:

N'utilisez pas de capsule dans le porte-capsule lors de l'utilisation des procédures de détartrage et de nettoyage.

## FR AVERTISSEMENT



Veillez lire le manuel avant d'utiliser la machine à café à capsule.



N'utilisez pas la machine à café lorsque le réservoir d'eau est vide.



Utilisez de l'eau froide propre pour remplir le réservoir d'eau. N'utilisez pas d'eau minérale, de lait ou d'autres liquides.



De l'air chaud se dégagera de la machine à café. Gardez une distance de sécurité.



Pendant la préparation du café, ne touchez pas directement la machine car la température peut être très élevée.



N'utilisez pas ou ne stockez pas la machine à café dans des environnements extrêmes.

## AVERTISSEMENT DE SÉCURITÉ



Gardez la prise propre et intacte.



Placez la machine à café à au moins 30 cm du mur ou d'autres matériaux inflammables.



Évitez l'électrocution - ne branchez pas ou ne débranchez pas avec les mains mouillées.



N'utilisez pas la machine à café à d'autres fins que celles prévues.



Gardez à l'écart des matériaux inflammables.



Tenez à l'écart des enfants.



Placez la machine à café sur une surface résistante à la chaleur et uniforme.



Usage domestique seulement.

## PARTICULARITÉS TECHNIQUES

- Tension nominale : 220-240V
- Fréquence nominale : 50/60Hz
- Puissance nominale : 1400W
- Capacité du réservoir d'eau : 800 ml
- Poids net : 2,85 Kg

Si vous avez des questions ou besoin d'aide avec votre machine à café, veuillez contacter [service@onyxcookware.fr](mailto:service@onyxcookware.fr)



### Comment se débarrasser du produit :

Cet appareil a été identifié conformément à la directive européenne relative aux Déchets d'équipements électriques et électroniques - WEEE.

Cela signifie que l'appareil peut être dangereux pour l'environnement et la santé des personnes, car il contient des substances dangereuses. Veuillez jeter ce produit au site de recyclage public.

## IT SCHEMA DEL PRODOTTO

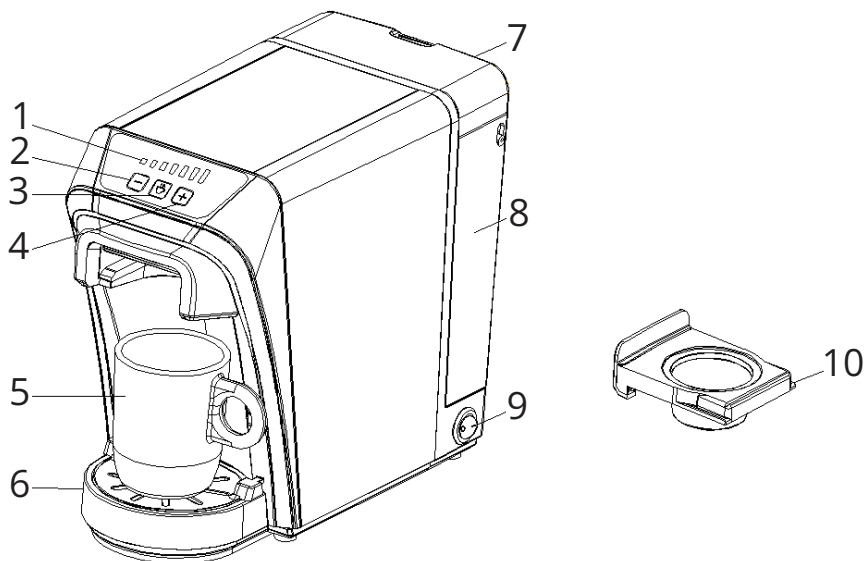

- ① Indicatore quantità d'acqua
- ② MENO: Ridurre la quantità d'acqua
- ③ Pulsante di avvio
- ④ PIÙ: Aumentare la quantità d'acqua
- ⑤ Tazza (Non inclusa)
- ⑥ Vassoio di raccolta gocce
- ⑦ Coperchio del serbatoio d'acqua
- ⑧ Serbatoio d'acqua rimovibile
- ⑨ Pulsante di accensione
- ⑩ Porta capsule Dolce Gusto

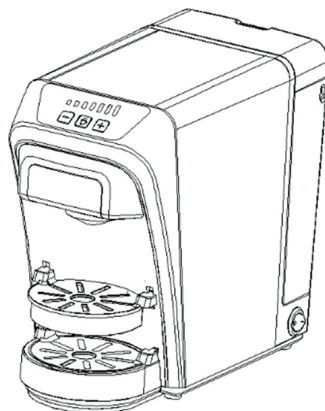







Il vassoio di raccolta gocce può essere regolato in base all'altezza della tazza.













# IT OPERAZIONI DI BASE

## PRIMA DELL'USO INIZIALE

-  Rimuovere tutto l'imballaggio.
-  Pulire il porta capsule con acqua calda, sapone per piatti e una spugna non abrasiva.
-  Pulire la macchina del caffè a capsule con un panno umido.
-  Posizionare su una superficie resistente al calore, stabile e livellata.
-  Controllare che tutte le parti siano correttamente installate e assicurarsi che non ci siano danni sulla macchina del caffè a capsule.
-  Riempire d'acqua il serbatoio, posizionare una tazza vuota sul vassoio di raccolta gocce e avviare la macchina alla massima capacità d'acqua. Non si consiglia di bere la prima tazza.

## COME FUNZIONA:

-  Sul serbatoio d'acqua sono indicate una linea minima e massima. Riempire sufficientemente d'acqua il serbatoio rimovibile, non deve superare il livello massimo d'acqua (massimo 800ml)
-  Collegare la spina di alimentazione, premere il pulsante di accensione su "ON", la spia  diventa blu e lampeggia, la macchina del caffè a capsule inizia a riscaldarsi.
-  Mettere una tazza sul vassoio di raccolta gocce, regolare il vassoio in base all'altezza della tazza. Assicurarsi che la tazza sia sotto l'uscita del caffè.
-  Inserire una capsula nel porta capsule e inserire il porta capsule nella camera di infusione. La spia rimarrà accesa quando il riscaldamento è terminato. Regolare la capacità della tazza in base alle proprie esigenze premendo il pulsante meno/più.
-  Premere il pulsante di avvio  per iniziare l'infusione, la luce del pulsante  rimarrà accesa.
-  La spia  rimarrà accesa dopo la fine dell'infusione.
-  Dopo un breve momento la macchina inizierà l'infusione. Una volta terminata l'infusione, rimuovere il porta capsule e gettare la capsula.

La macchina entrerà in modalità standby dopo l'infusione. Si spegnerà automaticamente se non ci sono operazioni entro 15 minuti.

# IT OPERAZIONI DI BASE

## GUIDA ALL'INFUSIONE



Se l'infusione si interrompe occasionalmente durante le operazioni, premere il pulsante , e premere nuovamente il pulsante per riavviare l'infusione.



La quantità d'acqua necessaria per l'infusione del tuo caffè a capsule dovrebbe essere indicata sulla confezione del marchio della capsula.

Dimensione dell'infusione	Emissione d'acqua	Dolce Gusto
1	Circa 50ml	Circa 30ml
2	Circa 70ml	Circa 50ml
3	Circa 90ml	Circa 70ml
4	Circa 120ml	Circa 100ml
5	Circa 150ml	Circa 130ml
6	Circa 200ml	Circa 180ml
7	About 260ml	About 240ml

\* I dati sopra riportati sono test di un certo marchio di capsule. I numeri possono essere utilizzati solo come approssimazioni.

\* L'emissione d'acqua si riferisce al volume d'acqua quando non c'è una capsula posizionata nella macchina.

Adattatore Dolce Gusto









Adattatore Nespresso













Adattatore per Caffè Macinato







-  Scollegare il cavo di alimentazione e lasciare raffreddare la macchina del caffè a capsule prima della pulizia.
-  Utilizzare un panno umido e pulito per pulire la superficie. Non utilizzare oggetti duri per la pulizia.
-  Evitare di colpire l'ago affilato sotto il coperchio superiore della macchina per evitare lesioni e malfunzionamenti del prodotto.
-  Rimuovere il vassoio di raccolta gocce, rimuovere il coperchio, lavarlo con sapone e acqua.
-  Pulire il serbatoio d'acqua di tanto in tanto o se non si è utilizzata la macchina del caffè a capsule per molto tempo.
-  Per evitare che i residui di latte rimangano nel porta capsule o nella camera di infusione, mettere l'accessorio Dolce Gusto nella camera di infusione e continuare a infondere due tazze d'acqua calda per pulire il porta capsule e la camera.

## DECALCIFICAZIONE

-  Riempire il serbatoio d'acqua con una miscela di acqua pulita e decalcificante domestico in rapporto 4:1. Nota che il rapporto di miscelazione del decalcificante può variare a seconda del marchio di decalcificante utilizzato. Si prega di fare riferimento alle istruzioni del produttore del decalcificante per il rapporto consigliato.
-  Mettere un grande contenitore sul vassoio di raccolta gocce, si consiglia di utilizzare un contenitore con una capacità superiore a 800 ml.
-  Collegare il cavo di alimentazione, mettere qualsiasi porta capsule (senza capsula) nella camera di infusione.
-  La macchina per capsule di caffè dovrebbe essere spenta.

Mentre il pulsante di accensione è spento, premere e tenere premuto il pulsante  , mentre si tiene  accendere il pulsante di accensione. Vedrai  lampeggiare alternativamente. Rilasciare  e premere di nuovo il pulsante. La macchina entrerà ora in modalità decalcificazione.
-  La luce del pulsante  rimane blu e la macchina inizia a pompare l'acqua dal serbatoio e inizia la modalità decalcificazione.

Dopo la decalcificazione, versare via l'acqua usata dal contenitore, riempire almeno 600 ml di acqua pulita nel serbatoio dell'acqua. Quando le luci dei pulsanti  lampeggiano di nuovo, premere il pulsante  e inizieranno le procedure di pulizia.
-  Dopo la pulizia la luce del pulsante  rimarrà blu e la macchina tornerà in modalità standby.

### NOTA:

Non utilizzare una capsula nel porta capsule durante le procedure di decalcificazione e pulizia.

## IT AVVERTENZE



Leggere il manuale prima di utilizzare la macchina del caffè a capsule.



Non utilizzare la macchina del caffè quando il serbatoio dell'acqua è vuoto.



Utilizzare acqua fredda pulita per riempire il serbatoio dell'acqua. Non utilizzare acqua minerale, latte o altri liquidi.



Dalla macchina del caffè fuoriesce aria calda. Mantenere una distanza di sicurezza.



Durante l'infusione del caffè, non toccare direttamente la macchina in quanto la temperatura può essere molto alta.



Non utilizzare o conservare la macchina del caffè in ambienti estremi.

## AVVISI RIGUARDANTI LA SICUREZZA



Mantenere la spina pulita e non danneggiata.



Posizionare la macchina del caffè ad almeno 30 cm dal muro o da altri materiali infiammabili.



Evitare scosse elettriche - non collegare o scollegare con le mani bagnate.



Non utilizzare la macchina del caffè per scopi diversi da quelli previsti.



Tenere lontano da materiali infiammabili.



Tenere lontano dai bambini.



Posizionare la macchina del caffè su una superficie resistente al calore e piana.



Solo per uso domestico.

## SPECIFICHE TECNICHE

- Tensione nominale: 220-240V
- Frequenza nominale: 50/60Hz
- Potenza nominale: 1400W
- Capacità del serbatoio d'acqua: 800 ml
- Peso netto: 2,85 Kg

Se avete domande o avete bisogno di aiuto con la vostra macchina del caffè, contattate [service@onyxcookware.it](mailto:service@onyxcookware.it)



### Smaltimento del prodotto:

Questo apparecchio è stato identificato in conformità alla direttiva europea che regola lo smaltimento di apparecchiature elettriche ed elettroniche (WEEE).

Ciò significa che l'elettrodomestico contiene sostanze dannose che potrebbero causare danni all'ambiente e alla salute delle persone. Consegnare questo prodotto al centro pubblico adibito al trattamento dei rifiuti.

# NL STRUCTUURSCHEMA VAN HET PRODUCT

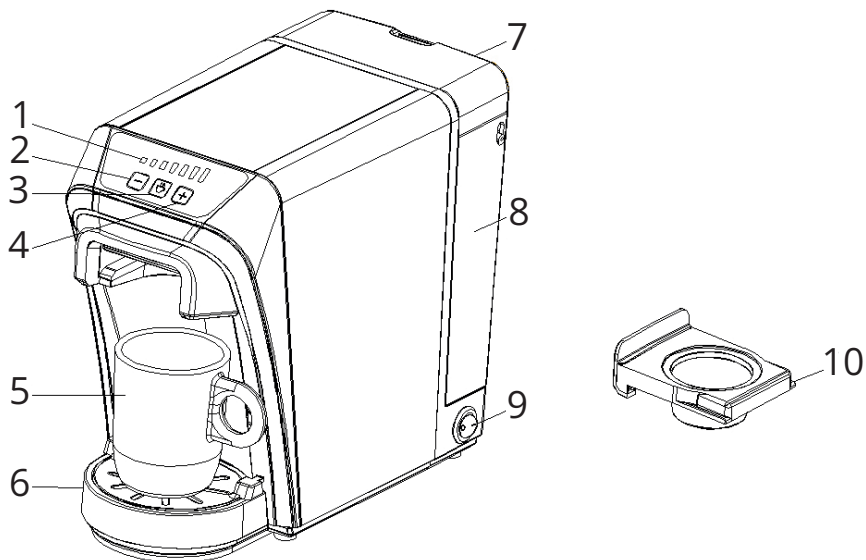

- ① Waterhoeveelheidsindicator
- ② MINUS: Waterhoeveelheid verminderen
- ③ Startknop
- ④ PLUS: Waterhoeveelheid verhogen
- ⑤ Kopje (niet inbegrepen)
- ⑥ Druppelbakje
- ⑦ Deksel van het waterreservoir
- ⑧ Uitneembaar waterreservoir
- ⑨ Aan/uit-knop
- ⑩ Dolce Gusto-capsulehouder

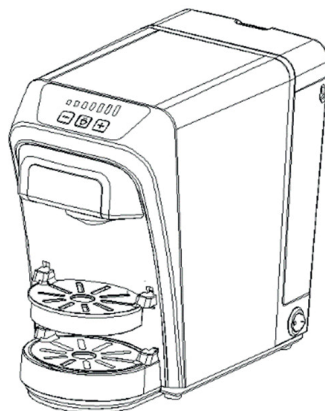

Het druppelbakje kan worden aangepast aan de hoogte van het kopje.

# NL ALGEMENE BEDIENINGSWIJZE

## VOOR EERST GEBRUIK

- ✓ Verwijder alle verpakkingen.
- ✓ Reinig de capsulehouder met heet water, afwasmiddel en een niet-schurende spons.
- ✓ Reinig de capsule koffiemachine met een vochtige doek.
- ✓ Plaats op een hittebestendige, stabiele en vlakke ondergrond.
- ✓ Controleer of alle onderdelen goed zijn geïnstalleerd en controleer of er geen schade is aan de capsule koffiemachine.
- ✓ Vul water in het waterreservoir, plaats een leeg kopje op het druppelbakje, en start de machine op de maximale watercapaciteit. Het eerste kopje wordt niet aanbevolen om te drinken.

## WERKING:

- 1 Er is een minimum en maximum lijn aangegeven op het waterreservoir. Vul voldoende water in het uitneembare waterreservoir, het mag het maximum waterniveau niet overschrijden (maximaal 800ml)
- 2 Sluit de stekker aan, druk op de aan/uit-knop om "AAN" te zetten, het indicatielampje  wordt blauw en knippert, de capsule koffiemachine begint op te warmen.
- 3 Zet een kopje op het druppelbakje, stel het druppelbakje af op de hoogte van het kopje. Zorg ervoor dat het kopje onder de koffie-uitloop staat.
- 4 Plaats een capsule in de capsulehouder en steek de houder in de zetkamer. Het indicatielampje blijft branden als het opwarmen klaar is. Stel de kopcapaciteit naar behoefte in door op de min-/plusknop te drukken.
- 5 Druk op de startknop  om te beginnen met zetten, het licht van de  knop blijft branden.
- 6 Het indicatielampje  blijft branden nadat het zetten klaar is.
- 7 Na een kort moment begint de machine met zetten. Als het zetten klaar is, haal de capsulehouder eruit en gooi de capsule weg.

De machine gaat na het zetten in de standby-modus. Het schakelt automatisch uit als er binnen 15 minuten geen bediening is.

✓ Als het zetten tijdens het gebruik af en toe stopt, druk dan op , en druk op de knop om het zetten opnieuw te starten.

✓ De hoeveelheid water die nodig is om uw capsulekoffie te zetten, moet op de verpakking van het capsulemerk staan.

Zetgrootte	Wateruitstroom	Dolce Gusto
1	Ongeveer 50ml	Ongeveer 30ml
2	Ongeveer 70ml	Ongeveer 50ml
3	Ongeveer 90ml	Ongeveer 70ml
4	Ongeveer 120ml	Ongeveer 100ml
5	Ongeveer 150ml	Ongeveer 130ml
6	Ongeveer 200ml	Ongeveer 180ml
7	Ongeveer 260ml	Ongeveer 240ml

\* Bovenstaande tabel is testdata van een bepaald merk capsules. De cijfers kunnen slechts als benadering worden gebruikt.

\* De wateruitstroom verwijst naar het volume water wanneer er geen capsule in de machine is geplaatst.

Dolce Gusto Adapter



Nespresso Adapter

















Gemalen Koffie Adapter



- ✓ Trek de stroomkabel uit het stopcontact en laat de capsule koffiemachine afkoelen voor het reinigen.
- ✓ Gebruik een schone vochtige doek om het oppervlak schoon te maken. Gebruik geen harde voorwerpen om schoon te maken.
- ✓ Vermijd het raken van de scherpe naald onder het deksel van de machine om letsel en productstoring te voorkomen.
- ✓ Haal het druppelbakje eruit, verwijder het deksel, was het met zeep en water.
- ✓ Reinig het waterreservoir af en toe of als u de capsule koffiemachine lange tijd niet heeft gebruikt.
- ✓ Om te voorkomen dat melkresten in de capsulehouder of zetkamer blijven plakken, doe de Dolce Gusto bijlage in de zetkamer en blijf twee kopjes heet water zetten om de houder en kamer te reinigen.

## ONTKALKEN

- 1 Vul het waterreservoir met een mengsel van schoon water en huishoudelijke ontkalker in een verhouding van 4:1. Let op, de verhouding van de ontkalker kan variëren afhankelijk van het merk ontkalker dat wordt gebruikt. Raadpleeg de instructies van de fabrikant van de ontkalker voor de aanbevolen verhouding.
- 2 Zet een grote container op het druppelbakje, het wordt aangeraden om een container te gebruiken met meer dan 800 ml capaciteit.
- 3 Sluit de stroomkabel aan, plaats een willekeurige capsulehouder (zonder capsule) in de zetkamer.
- 4 De koffiecapsule machine moet uitgeschakeld zijn.  
  
Terwijl de aan/uit-knop uit staat, houd de knop  ingedrukt, terwijl je  vasthoudt, zet je de aan/uit-knop aan. Je zult    afwisselend zien knipperen. Laat  los en druk nogmaals op de knop. De machine gaat nu in de ontkalkingsmodus.
- 6 Het licht van de knop  blijft blauw en de machine begint water uit het reservoir te pompen en begint met de ontkalkingsmodus.
- 7 Na het ontkalken, giet het gebruikte water uit de container, vul ten minste 600ml schoon water in het waterreservoir. Wanneer het licht van de knoppen    weer knippert, druk op de knop  en de reinigingsprocedures zullen beginnen.
- 8 Na het schoonmaken blijft het licht van de knop    blauw en de machine keert terug naar de stand-bymodus.

### LET OP:

Gebruik geen capsule in de capsulehouder tijdens het gebruik van ontkalkings- en reinigingsprocedures.



# NL VOORZORGSMAATREGELEN



Lees de handleiding voordat u de Capsule koffiemachine gebruikt.



Gebruik de koffiemachine niet wanneer het waterreservoir leeg is.



Gebruik schoon koud water om het waterreservoir te vullen. Gebruik geen mineraalwater, melk of andere vloeistoffen.



Er komt hete lucht uit de koffiemachine. Houd een veilige afstand.



Raak de machine niet direct aan terwijl de koffie wordt gezet, omdat de temperatuur erg hoog kan zijn.



Bedien of bewaar de koffiemachine niet in extreme omstandigheden.

## VEILIGHEIDSWAARSCHUWING



Houd de stekker schoon en onbeschadigd.



Plaats de koffiemachine minimaal 30 cm van de muur of andere brandbare materialen.



Vermijd elektrische schok - steek de stekker niet in of uit met natte handen.



Gebruik de koffiemachine niet voor andere dan het bedoelde gebruik.



Blijf uit de buurt van brandbare materialen.



Houd kinderen op afstand.



Plaats de koffiemachine op een hittebestendig en vlak oppervlak.



Alleen voor huishoudelijk gebruik.

## TECHNISCHE SPECIFICATIES

- Nominale spanning: 220-240V
- Nominale frequentie: 50/60Hz
- Nominale vermogen: 1400W
- Capaciteit van het waterreservoir: 800 ml
- Netto gewicht: 2,85 Kg

Als u vragen heeft of hulp nodig heeft met uw koffiemachine, neem dan contact op met [service@onyxcookware.nl](mailto:service@onyxcookware.nl)



### Het product afvoeren:

Dit apparaat valt onder de Europese richtlijn betreffende afgedankte elektrische en elektronische apparatuur (WEEE).



Dit betekent dat het apparaat een gevaar kan inhouden voor het milieu en de volksgezondheid omdat het gevaarlijke stoffen bevat. Voer dit product alleen af via een openbaar recyclingcentrum.

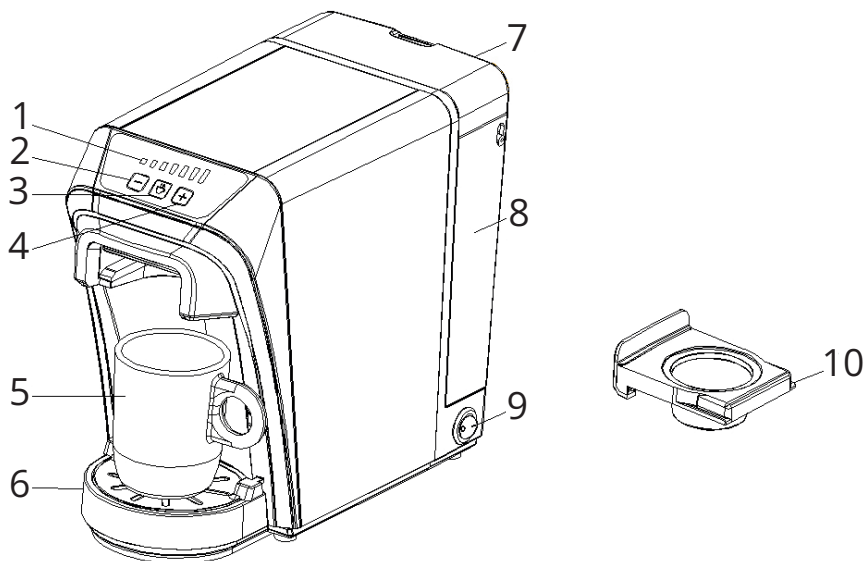

- ① Vattenmängdsindikator
- ② MINUS: Minska vattenmängden
- ③ Startknapp
- ④ PLUS: Öka vattenmängden
- ⑤ Kopp (Ingår ej)
- ⑥ Droppbricka
- ⑦ Lock för vattentank
- ⑧ Avtagbar vattentank
- ⑨ Strömbrytare
- ⑩ Dolce Gusto kapselhållare

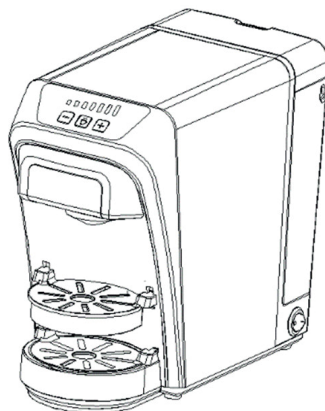







Droppbrickan kan justeras efter koppen höjd.

## INNAN FÖRSTA ANVÄNDNING

- ✓ Ta bort all förpackning.
- ✓ Rengör kapselhållaren med varmt vatten, diskmedel och en icke-slipande svamp.
- ✓ Rengör kapselkaffemaskinen med en våt trasa.
- ✓ Placera på en värmematlig, stabil och plan yta.
- ✓ Kontrollera att alla delar är korrekt installerade och att det inte finns någon skada på kapselkaffemaskinen.
- ✓ Fyll på vatten i vattentanken, placera en tom kopp på droppbrickan och starta maskinen på maximal vattenmängd. Det rekommenderas inte att dricka första koppen.

## SÅ HÄR FUNGERAR DET:

- 1 Det finns en minimi- och maximilinj på vattentanken. Fyll tillräckligt med vatten i den avtagbara vattentanken, den får inte överskrida den maximala vattennivån (maximalt 800 ml)
- 2 Anslut strömkontakten, tryck på strömbrytaren till "PÅ", indikeringslampan   blir blå och blinkar, kapselkaffemaskinen börjar värma upp.
- 3 Placera en kopp på droppbrickan, justera droppbrickan efter kopphöjden. Se till att koppen är under kaffeutloppet.
- 4 Placera en kapsel i kapselhållaren och sätt in hållaren i bryggkammaren. Indikeringslampan lyser konstant när uppvärmningen är klar. Justera koppkapaciteten efter dina behov genom att trycka på minus/plus-knappen.
- 5 Tryck på startknappen  för att börja brygga, -knappens lampa lyser konstant.
- 6 Indikeringslampan   lyser konstant efter att bryggningen är klar.
- 7 Efter en kort stund börjar maskinen brygga. När bryggningen är klar, ta ut kapselhållaren och kasta kapseln.

Maskinen går in i standby-läge efter bryggningen. Den stänger av automatiskt om det inte finns någon aktivitet inom 15 minuter.



Om bryggningen ibland stannar under drift, tryck då på , och tryck på knappen igen för att starta om bryggningen.



Den mängd vatten som behövs för att brygga ditt kapselkaffe ska stå på kapselmärkets förpackning.

Bryggstorlek	Vattenutmatning	Dolce Gusto
1	Cirka 50ml	Cirka 30ml
2	Cirka 70ml	Cirka 50ml
3	Cirka 90ml	Cirka 70ml
4	Cirka 120ml	Cirka 100ml
5	Cirka 150ml	Cirka 130ml
6	Cirka 200ml	Cirka 180ml
7	Cirka 260ml	Cirka 240ml

\* Ovanstående tabell är testdata för ett visst kapselmärke. Siffrorna kan endast användas som ungefärliga värden.

\* Vattenutmatningen refererar till vattenmängden när det inte finns någon kapsel placerad i maskinen.

Dolce Gusto-adapter



Nespresso-adapter















Malt Kaffe-adapter



- ✓ Dra ur strömkabeln och låt kapselkaffemaskinen svalna innan rengöring.
- ✓ Använd en ren fuktig trasa för att rengöra ytan. Använd inte några hårda föremål för att rengöra.
- ✓ Undvik att slå till den skarpa nålen under maskinens övre lock för att undvika skador och produktfel.
- ✓ Ta ut droppbrickan, ta bort locket, tvätta det med tvål och vatten.
- ✓ Rengör vattentanken då och då eller om du inte har använt kapselkaffemaskinen på länge.
- ✓ För att förhindra att mjölkkränder kvarstår i kapselhållaren eller bryggkammaren, placera Dolce Gusto-fästet i bryggkammaren och fortsätt att brygga två koppar hett vatten för att rengöra hållaren och kammaren.

## AVKALKNING

- 1 Fyll vattentanken med en blandning av rent vatten och hushålls avkalkare i ett förhållande 4:1. Observera att avkalkningsmedelsblandningsförhållandet kan variera beroende på vilket avkalkningsmedel som används. Vänligen referera till avkalkningsmedelstillverkarens anvisningar för det rekommenderade förhållandet.
- 2 Placera en stor behållare på droppbrickan, det rekommenderas att använda en behållare med mer än 800 ml kapacitet.
- 3 Anslut strömkabeln, placera någon kapselhållare (Utan kapsel) i bryggkammaren.
- 4 Kaffekapselmaskinen ska vara avstängd.
- 5 Medan strömbrytaren är avstängd, tryck och håll knappen , medan du håller  sätt på strömbrytaren. Du kommer att se  blinka växelvis. Släpp av  och tryck på knappen igen. Maskinen kommer nu att gå in i avkalkningsläge.
- 6 Knappen  lyser blått och maskinen börjar pumpa vatten från tanken och börjar avkalkningsläget.
- 7 Efter avkalkning, håll bort det använda vattnet från behållaren, fyll minst 600 ml rent vatten i vattentanken. När knapparna    blinkar igen, tryck på knappen  och rengöringsprocedurerna startar.
- 8 Efter rengöring kommer knappen    att lysa blått och maskinen återgår till standby-läge.

### OBS:

Använd inte en kapsel i kapselhållaren när du använder avkalknings- och rengöringsprocedurer.

# SE VARNINGAR



Läs manualen innan du använder kapselkaffemaskinen.



Använd inte kaffemaskinen när vattentanken är tom.



Använd rent kallt vatten för att fylla vattentanken. Använd inte mineralvatten, mjölk eller andra vätskor.



Het luft kommer att uppstå från kaffemaskinen. Håll ett säkert avstånd.



Medan kaffebrygning pågår, rör inte direkt vid maskinen eftersom temperaturen kan vara mycket hög.



Använd inte eller förvara kaffemaskinen i några extrema miljöer.

## SÄKERHETSVARNING



Håll kontakten ren och oskadad.



Placera kaffemaskinen minst 30 cm från väggen eller annat brännbart material.



Undvik elektrisk stöt - stick inte in eller dra ur med våta händer.



Använd inte kaffemaskinen för annat än dess avsedda användning.



Håll borta från brännbart material.



Håll borta från barn.



Placera kaffemaskinen på en värmetålig och jämn yta.



Endast för hushållsanvändning.

## TEKNISKA SPECIFIKATIONER

- Nominell spänning: 220-240V
- Nominell frekvens: 50/60Hz
- Nominell effekt: 1400W
- Vattentankkapacitet: 800 ml
- Netto vikt: 2,85 kg

Om du har några frågor eller behöver hjälp med din kaffemaskin, vänligen kontakta [service@onyxcookware.se](mailto:service@onyxcookware.se)



### Så här kasserar du produkten:



Den här apparaten har identifierats i enlighet med europeiska direktivet om avfall som utgörs av eller innehåller elektrisk och elektronisk utrustning (WEEE).



Det innebär att den kan vara skadlig för miljön och människors hälsa på grund av att den innehåller farliga ämnen. Vänligen kassera den här produkten vid en offentlig återvinningsstation.

# NO PRODUKTSTRUKTURDIAGRAM

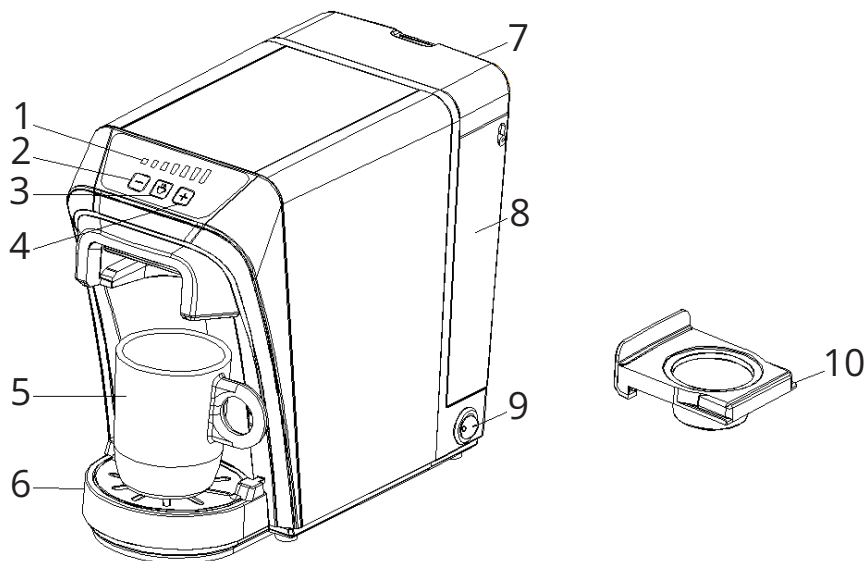

- ① Vannmengdeindikator
- ② MINUS: Reduserer vannmengde
- ③ Start-knapp
- ④ PLUSS: Øker vannmengde
- ⑤ Kopp (ikke inkludert)
- ⑥ Dryppbrett
- ⑦ Lokk for vanntank
- ⑧ Avtakbar vanntank
- ⑨ Strømbryter
- ⑩ Dolce Gusto kapselholder

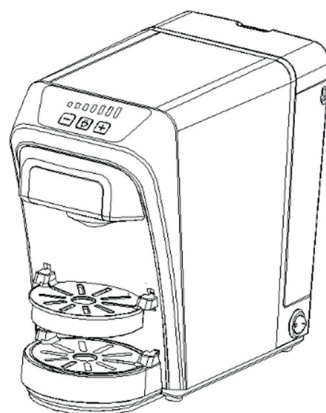





Dryppbrettet kan justeres etter høyden på koppen.

# NO GRUNNLEGGENDE OPERASJONER

## FØR FØRSTE GANGS BRUK

- ✓ Fjern all emballasjen.
- ✓ Rengjør kapselholderen med varmt vann, oppvaskmiddel, og en ikke-skrubbande svamp.
- ✓ Rengjør kapselkaffemaskinen med en fuktig klut.
- ✓ Plasser på en varmebestandig, stabil og flat overflate.
- ✓ Kontroller at alle delene er riktig installert og sørg for at det ikke er noen skader på kapselkaffemaskinen.
- ✓ Fyll vann i vanntanken, plasser en tom kopp på dryppbrettet, og start maskinen på maksimal vannmengdekapasitet. Den første koppen er ikke foreslått for drikking.

## HVORDAN DET VIRKER:

- 1 Det er en minimums- og maksimumslinje indikert på vanntanken. Fyll tilstrekkelig vann i den avtakbare vanntanken, det skal ikke overstige maksimalt vannnivå (maks 800ml)
- 2 Koble til strømpluggen, trykk på strømbryteren til "PÅ", indikatorlyset  blir blått og blinker, kapselkaffemaskinen begynner å varme opp.
- 3 Sett en kopp på dryppbrettet, juster dryppbrettet i forhold til høyden på koppen. Sørg for at koppen er under kaffeutgangshullet.
- 4 Sett en kapsel inn i kapselholderen og sett holderen inn i bryggekompartimentet. Indikatorlyset vil lyse konstant når oppvarmingen er ferdig. Juster koppkapasiteten etter dine behov ved å trykke på minus/pluss-knappen.
- 5 Trykk på startknappen  for å starte brygging, -knappelyset vil lyse konstant.
- 6 Indikatorlyset  vil lyse konstant etter at bryggingen er ferdig.
- 7 Etter et kort øyeblikk vil maskinen starte bryggingen. Når bryggingen er ferdig, ta ut kapselholderen og kast kapselen.

Maskinen vil gå inn i stand-by-modus etter brygging. Den vil automatisk slå seg av hvis det ikke er noen operasjon innen 15 minutter.



# NO GRUNNLEGGENDE OPERASJONER

## BRYGGING GUIDE

✓ Hvis bryggingen av og til stopper under drift, trykk deretter på , og trykk på knappen igjen for å starte bryggingen på nytt.

✓ Mengden vann som trengs for å brygge kapselkaffen din, bør være skrevet på pakken til kapselmerket.

Bryggestørrelse	Vannutslipp	Dolce Gusto
1	Omtrent 50ml	Omtrent 30ml
2	Omtrent 70ml	Omtrent 50ml
3	Omtrent 90ml	Omtrent 70ml
4	Omtrent 120ml	Omtrent 100ml
5	Omtrent 150ml	Omtrent 130ml
6	Omtrent 200ml	Omtrent 180ml
7	Omtrent 260ml	Omtrent 240ml

\* Tabellen ovenfor er testdata fra et bestemt kapselmerke. Tallene kan bare brukes som omtrentlige verdier.

\* Vannutslippet refererer til vannvolumet når det ikke er plassert en kapsel i maskinen.

Dolce Gusto Adapter



Nespresso Adapter



Malt Kaffe Adapter



# NO STELL OG VEDLIKEHOLD

- ✓ Trekk ut strømkabelen og la kapselkaffemaskinen kjøle ned før rengjøring.
- ✓ Bruk en ren fuktig klut for å rengjøre overflaten. Ikke bruk harde gjenstander til å rengjøre.
- ✓ Unngå å treffe den skarpe nålen under maskinens øvre lokk for å unngå skade og produktfeil.
- ✓ Ta ut dryppbrettet, fjern dekselet, vask det med såpe og vann.
- ✓ Rengjør vanntanken av og til eller hvis du ikke har brukt kapselkaffemaskinen på lang tid.
- ✓ For å forhindre at melkerester som gjenstår i kapselholderen eller bryggekommeret kleber seg fast, sett Dolce Gusto-vedlegget i bryggekommeret og fortsett å brygge to kopper varmt vann for å rengjøre holderen ogammeret.

## AVKALKING

- 1 Fyll vanntanken med en blanding av rent vann og husholdningsavkalker i et 4:1-forhold. Merk at avkalkingsblandingsforholdet kan variere avhengig av merket av avkalker som brukes. Vennligst se produsentens instruksjoner for avkalker for det anbefalte forholdet.
- 2 Sett en stor beholder på dryppbrettet, det anbefales å bruke en beholder med mer enn 800 ml kapasitet.
- 3 Koble til strømkabelen, sett en hvilken som helst kapselholder (uten kapsel) inn i bryggekommeret.
- 4 Kaffekapselmaskinen skal være slått av.
- 5 Mens strømbryteren er slått av, trykk og hold knappen , mens du holder  slå på strømbryteren. Du vil se  blinker vekselvis. Slipp  og trykk på knappen igjen. Maskinen vil nå gå inn i avkalkingsmodus.
- 6 Knappen  lyser blått og maskinen starter å pumpe vann fra tanken og begynner avkalkingsmodus.
- 7 Etter avkalking, tøm bort det brukte vannet fra beholderen, fyll minst 600ml rent vann i vanntanken. Når knappene    lyser igjen, trykk på knappen  og rengjøringsprosedyrene vil starte.
- 8 Etter rengjøring vil   -knappen lyse blått og maskinen vil returnere til standby-modus.

### MERK:

Ikke bruk en kapsel i kapselholderen når du bruker avkalkings- og rengjøringsprosedyrer.

# NO FORSIKTIG



Vennligst les manualen før du bruker kapselkaffemaskinen.



Ikke bruk kaffemaskinen når vanntanken er tom.



Bruk rent kaldt vann for å fylle vanntanken. Ikke bruk mineralvann, melk eller andre væsker.



Varm luft vil oppstå fra kaffemaskinen. Hold en sikker avstand.



Mens kaffebyggingen pågår, må du ikke røre maskinen direkte da temperaturen kan være veldig høy.



Ikke bruk eller oppbevar kaffemaskinen i ekstrene miljøer.

## SIKKERHETSADVARSEL



Hold støpselet rent og uskadet.



Plasser kaffemaskinen minst 30 cm fra veggen eller andre brennbare materialer.



Unngå elektrisk støt - ikke plugg eller unplugg med våte hender.



Ikke bruk kaffemaskinen til annet enn det den er ment for.



Hold borte fra brennbare materialer.



Hold borte fra barn.



Plasser kaffemaskinen på en varmebestandig og jevn overflate.



Kun for bruk i husholdningen.

## TEKNISKE SPESIFIKASJONER

- Nominell spenning: 220-240V
- Nominell frekvens: 50/60Hz
- Nominell effekt: 1400W
- Vanntankkapasitet: 800 ml
- Netto vekt: 2,85 Kg

Hvis du har spørsmål eller trenger hjelp med kaffemaskinen din, vennligst kontakt [service@onyxcookware.no](mailto:service@onyxcookware.no)



### Slik avhendes produktet:

Dette apparatet er identifisert i samsvar med det europeiske direktivet om avfall av elektrisk og elektronisk utstyr – WEEE.



Dette betyr at apparatet kan utgjøre en fare for miljøet og menneskers helse, siden det inneholder farlige stoffer. Avhend dette produktet til offentlig kildesortering.





✉ [service@onyxcookware.eu](mailto:service@onyxcookware.eu)