

# DC500 Series Door Closers

## Classic Product

The Arrow DC500 Series Heavy Duty Surface Applied Door Closers are ideal for Institutions or other high traffic applications. The DC500 is designed for end users looking for value and versatility in a rugged design making this series suitable for a wide variety of applications.

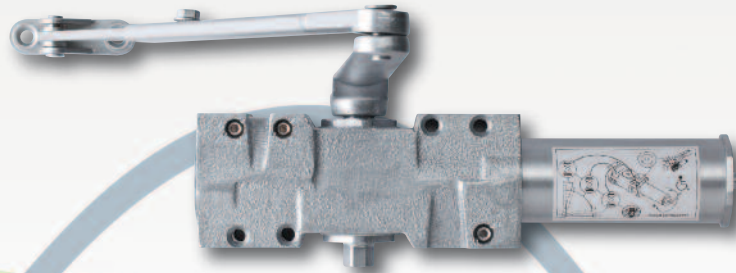

### Compliance:

- UL/cUL listed.
- UL10C listed for positive pressure to comply with UBC-72 (1997).
- Meets the requirements of ANSI A156.4 and ANSI ICC A117.1. Grade 1
- Meets ADA requirements (Americans with Disabilities Act).



Look for the universal symbol next to Arrow products that comply with ADA accessibility requirements.

### Sizes (Adjustable):

- DC516 closers are adjustable for spring sizes 1 through 6.

Interior Door Width	24"	30"	34"	38"	48"	54"	60"
	(610mm)	(762mm)	(865mm)	(965mm)	(1219mm)	(1372mm)	(1524mm)
Regular Arm & Top Jamb	Size 1	Size 2	Size 3	Size 4	Size 5	Size 6	
Parallel Arm	Size 2	Size 3	Size 4	Size 5	Size 6		

Exterior (& Vestibule) Door Width	24"	30"	36"	42"	48"
	(610mm)	(762mm)	(914mm)	(1067mm)	(1219mm)
Regular Arm & Top Jamb	Size 3	Size 4	Size 5	Size 6	
Parallel Arm	Size 4	Size 5	Size 6		

### Features:

- Heavy duty cast iron body.
- Hardened steel rack and pinion.
- High tensile steel springs.
- Staked valves
- Two non-critical adjusting valves (sweep and latch) control closing speed.
- Backcheck intensity valve.
- All temperature fluid.
- Full plastic cover standard.
- Non-handed for regular, top jamb and parallel arm mount applications.
- Supplied with fully threaded self-reaming/tapping screws, sleeve nuts and thru-bolts for 1-3/4" thick doors.

- DC516-1 Series door closers are supplied with a hold open arm.
- DC516-2 has a heavy duty parallel arm with a stop feature for door openings between 90° and 110°.
- DC516-3 has a heavy duty parallel arm with a stop and thumb turn hold open feature for door openings between 90° and 110°.
- Packaging: one per box and four boxes per carton.
- 10 year limited warranty.

### Finishes:

- Aluminum (689), Specify AL
- Dark Bronze (690), Specify DBZ

### Regular Arm Installation

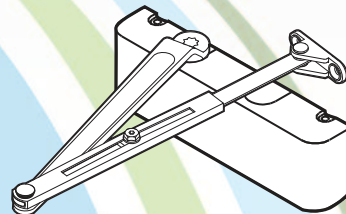

### Top Jamb Installation

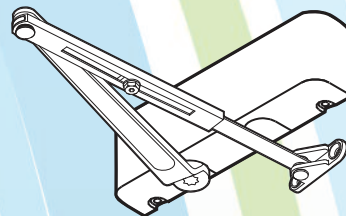

### Parallel Arm Installation

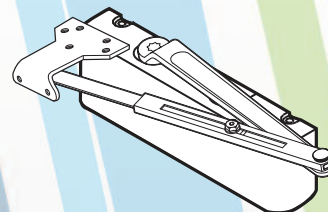

### Heavy Duty Parallel Arm Installation

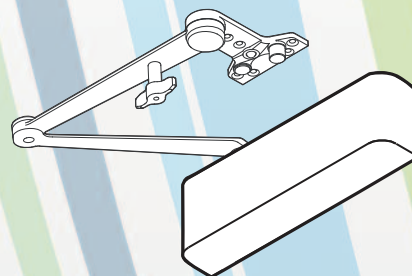

# DC500 Series Door Closers

## Classic Product

### Regular Arm Installation

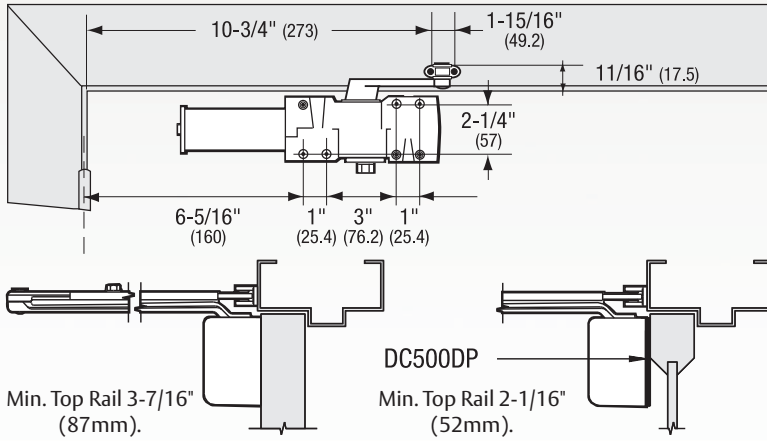

### Parallel Arm Installation (180° maximum door swing template illustrated).

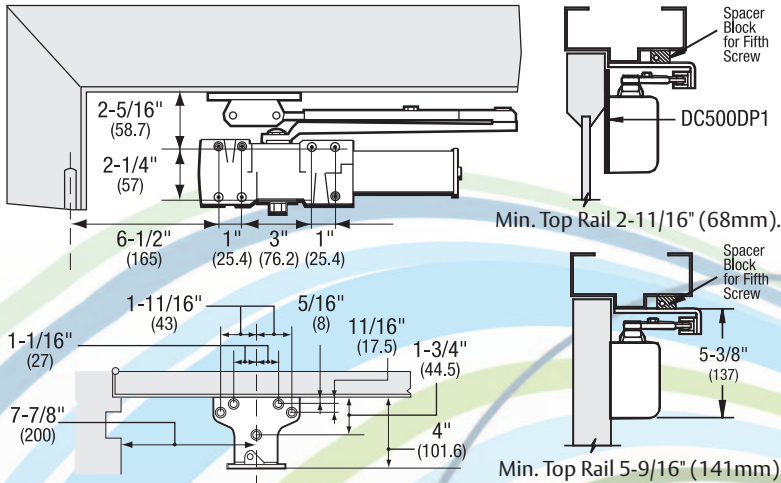

### Top Jamb Installation

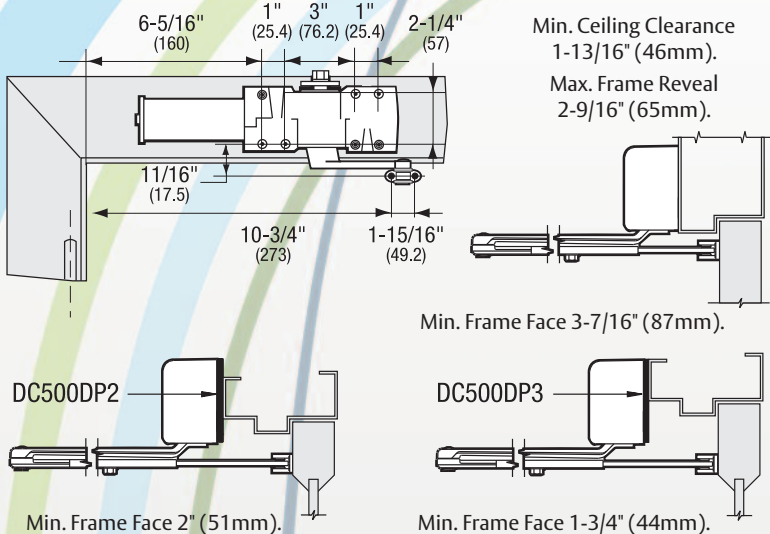

### Parts:

Cover with Screw Pack  
• DC500COV

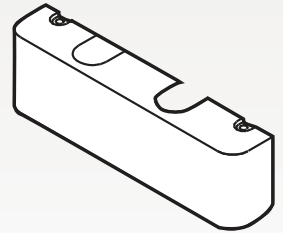

Non-Hold Open Arm (Standard with)  
• DC516

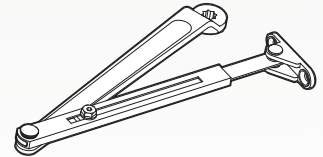

(To order separately)  
• DC500A

Hold Open Arm (Standard with)  
• DC516-1

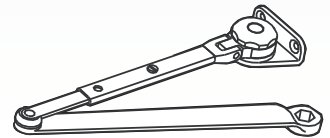

(To order separately)  
• DC500A1

### Drop Plates

Regular Arm Application  
• DC500DP

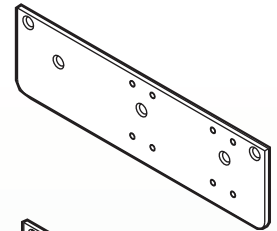

Parallel Arm Application  
• DC500DP1

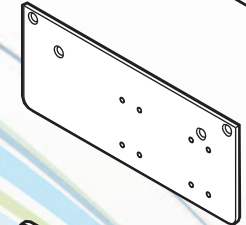

Top Jamb Application  
• DC500DP2

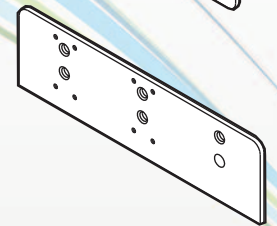

Top Jamb Low Ceiling Application  
• DC500DP3

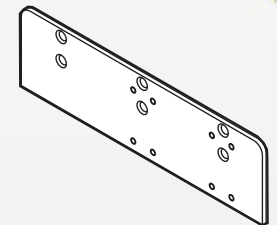

# DC500 Series Door Closers

## Classic Product

### Heavy Duty Parallel Arm with a choice:

- DC516-2 – Non-Hold Open Arm with Stop Feature
- DC516-3 – Thumbturn Hold Open Arm with Stop Feature
- Door Closer can be installed to stop door at: 85°, 90°, 100° or 110° of door swing.

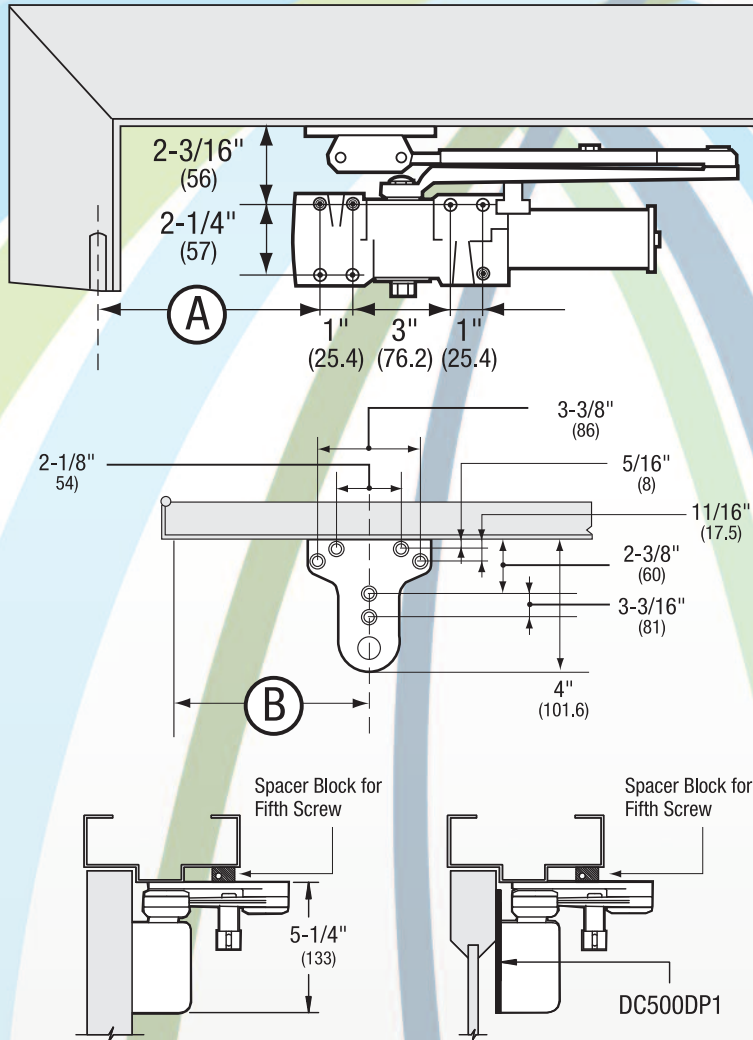

### Parts:

#### Heavy Duty Parallel Arm Non-Hold Open with Stop Feature (Standard with)

- DC516-2

(To order separately)

- DC500A2

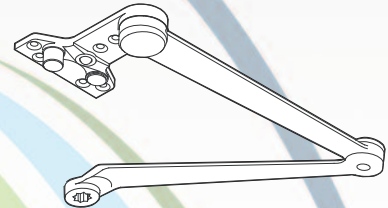

#### Heavy Duty Parallel Arm with Thumbturn Hold Open and Stop Feature (Standard with)

- DC516-3

(To order separately)



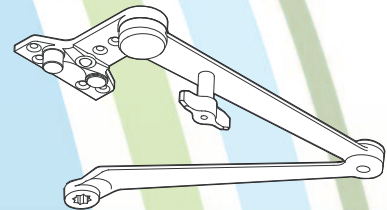

- DC500A3

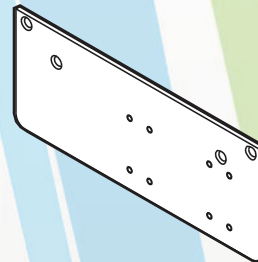

#### Drop Plate

- DC500DP1



"A" Dimension	9-1/2" (241)	8-3/4" (222)	7-5/8" (194)	6-5/8" (168)
"B" Dimension	11-1/8" (283)	10-1/2" (267)	9-1/4" (235)	8-3/8" (213)
Degree of Stop	85° 	90° 	100° 	110° 

# DC500 Series Door Closers

## Classic Product

### How to order the DC500 Series

#### Ordering Example:

Quantity	Part Number	Finish
20	DC516-3	• AL

#### Complete Units:

	Part No.
Size 1-6, Non-Hold Open Arm with PA Bracket, Full Plastic Cover, Screw Pack, 1-3/4" Thru-bolts .....	DC516
Size 1-6, Hold Open Arm with PA Bracket, Full Plastic Cover, Screw Pack, 1-3/4" Thru-bolts .....	DC516-1
Size 1-6, Heavy-Duty Dead Stop NHO, Full Plastic Cover, Screw Pack, 1-3/4" Thru-bolts .....	DC516-2
Size 1-6, Heavy-Duty Dead Stop HO, Full Plastic Cover, Screw Pack, 1-3/4" Thru-bolts .....	DC516-3

#### Parts & Accessories:

	Part No.
Full Plastic Cover .....	DC500CV
Drop Plate - Regular .....	DC500DP
Drop Plate - Parallel Arm .....	DC500DP1
Drop Plate - Top Jamb .....	DC500DP2
Drop Plate - Top Jamb, Flush Ceiling .....	DC500DP3
Thru-bolts 1-3/4" .....	DC500TB1
Thru-bolts 1-3/8" .....	DC500TB3
Thru-bolts 2-1/4" .....	DC500TB2
Supplemental Reaming/Tapping Screw Pack .....	DC500SP1
Standard Screw Pack .....	DC500SP2
Standard Non-Hold Open Arm .....	DC500A
Standard Hold Open Arm .....	DC500A1
Heavy-Duty Dead Stop Arm Non-Hold Open .....	DC500A2
Heavy-Duty Dead Stop Arm Hold Open .....	DC500A3

Specify Finish **AL** or **DBZ**.