



# Cylinders/Keys

## Cylinders and Keying Catalog



# Table of Contents



## Contents

|   |       |
|---|-------|
| Finishes & How to Order .....               | 2     |
| Yale® KeyMark® and KeyWizard® .....         | 3     |
| Cylinder and Key Stamping .....             | 4     |
| Special Features                            |       |
| Construction Master Keying .....            | 5     |
| Interchangeable Core .....                  | 5     |
| Bump Resistant .....                        | 6     |
| Hotel Function .....                        | 6     |
| Security/High Security .....                | 7     |
| Cylinder Types                              |       |
| Mortise .....                               | 8-10  |
| Rim .....                                   | 11-13 |
| Component .....                             | 14-17 |
| Interchangeable Core .....                  | 18    |
| Key Blanks .....                            | 19-20 |
| Keyways .....                               | 21    |
| Cams .....                                  | 22    |
| Collars .....                               | 23    |
| Service Equipment, Parts, Dust Shields..... | 24-27 |
| Pinning Specifications .....                | 28-29 |
| Policies and Procedures .....               | 30    |
| Designing Master Key Systems .....          | 31    |
| How to Establish Key Systems .....          | 32-34 |

## How To Order Cylinders

When ordering cylinders separately, the following details should be specified. Cylinders ordered with Yale products will be provided to accommodate those products. Detailed information can also be found in the individual product catalogs.

| Model # | Length | Cam  | Collar   | No. of Pins | Keyway | Finish |
|---------|--------|------|----------|-------------|--------|--------|
| 2153    | 1-1/8" | 2160 | 1765.250 | 6           | GA     | 626    |

## How To Order KeyWizard®

All KeyWizard programs are licensed specifically to each facility end user. Special online ordering procedures apply. The following information is required for each system:

- End user facility name
- End user contact person
- Mailing address
- Phone number

## Cylinders/Keys

Today's facilities require flexible options when it comes to security. Thanks to recent technological changes in the security industry, modern commercial buildings have a variety of choices of how access to each opening is controlled. Mechanical key cylinders continue to provide strong traditional security, but many facilities favor a combination of mechanical and electronic security products for convenient access with an audit trail.

Yale offers a range of cylinder options, including conventional, interchangeable core, security, high security and Yale KeyMark®. Providing an array of cylinders, keys and keying systems that meet the needs of any facility, Yale Works for You<sup>SM</sup>.

## Finishes

| ANSI/BHMA Code | Finish Description                      |
|----------------|---|
| 605            | Bright Brass, Clear Coated              |
| 606            | Satin Brass, Clear Coated               |
| 611            | Bright Bronze, Clear Coated             |
| 612            | Satin Bronze, Clear Coated              |
| 613E           | Dark Oxidized Satin Bronze - equivalent |
| 618            | Bright Nickel Plated, Clear Coated      |
| 619            | Satin Nickel Plated, Clear Coated       |
| 625            | Bright Chrome Plated                    |
| 626            | Satin Chrome Plated                     |
| 629            | Bright Stainless Steel                  |
| 630            | Satin Stainless Steel                   |
| 693            | Black Painted                           |
| BSP            | Black Suede Powder Coat                 |
| WSP            | White Suede Powder Coat                 |

### Notes:

- Rim cylinders not available in 629 or 630 finishes.
- Component plugs only provided in 606 and 626

Certified ANSI/BHMA A156.5, Grade 1



# Yale® KeyMark® and KeyWizard®



## Yale® KeyMark®

Yale® KeyMark® protected keyway line of cylinders feature an angled keyway designed to accept any keyblank constructed with the same angle, allowing all key formats to be tied to the same master key system. Security Leg® prohibits other manufacturers' keys from entering the cylinder, prevents unauthorized duplication of keys and offers increased picking resistance against intruders. Cylinders include mortise, rim, component, auxiliary, and interchangeable core. Interchangeable core is available in both large and small format. For more information and details on Yale KeyMark cylinders please refer to separate catalog section.



## KeyWizard®

A key management software program is essential for any type of organization. Keeping track of the key holders in a master key system is critical for maintaining key control and ensuring the security and integrity of the system.



KeyWizard by Yale® is a comprehensive key management software program was designed for facility end users to track detailed information concerning their keying system. It offers improvements over existing key management software by utilizing clutter-free and easily navigated screens.

KeyWizard by Yale provides the facility with accurate information concerning keys, key holders, hardware locations, master key systems, overdue keys and maintenance service schedules, all of which can be customized.

For more information about KeyWizard® including demo versions, please visit [www.yalelocks.com](http://www.yalelocks.com) or [www.keywizard.net](http://www.keywizard.net). For KeyWizard technical support, please call 1-800-610-1706.

# Cylinders and Key Stamping



Keys and/or cylinders stamped with their respective keyset symbols allows for easy identification and will reduce the chance of confusion between cylinders, keys and the lockset during and after installation. The information on the cylinder allows for easy identification of the levels of security within that particular cylinder.

## Visual Key Control (VKC)

For convenience, specify VKC and the key symbol is stamped on the plug face or other visible portion of the front of the cylinder. (VKC is available on all keys, but not available on security, high security or Yale® KeyMark® cylinders.)

## Concealed Key Control (CKC)

For greater security, specify CKC on the cylinders. The key symbol is stamped in a concealed location, such as the rear of the cylinder. It is not visible to the general occupants of the building but can be accessed by authorized personnel upon removing the cylinder from the lockset.

For example, the symbol AA1 shown in the illustration identifies the lock to be operated by grand master key A, master key AA and change key AA1. Upon written authorization from the building owner to an authorized Yale® Distributor, a bitting list can be supplied for each job to translate the symbols into key bittings.

If a key is lost, it can easily be replaced by referring to the symbol on the cylinder and the bitting on the bitting list. VKC is not available on security, high security or Yale® KeyMark® cylinders.

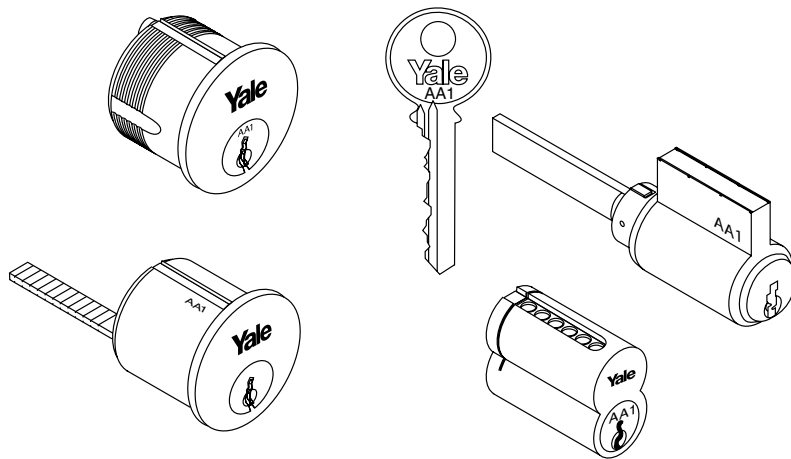

## Key Stamping Code Definitions

| Code | Definition   |
|------|--|
| VKC0 | No keyset, registry number, or bitting stamping any keys. Includes master keys and change keys. Keys will be stamped with keyway designation. (Keys will be tagged.)   |
| VKC1 | Master keys stamped with their keyset symbol and registry number. Change keys stamped with their keyset symbol (Standard for high security, security and Yale® KeyMark® cylinders.)  |
| VKC2 | Master keys stamped with their keyset symbol and registry number. Change keys stamped with their keyset symbol. Cylinders stamped with their keyset symbol on the face of the plug. (Not available for high security cylinders, security cylinders or Yale KeyMark.) |
| VKC3 | Master keys stamped with their keyset symbol and registry number. Change keys stamped with their bitting. Cylinders stamped with their keyset symbol on the face of the plug. (Not available for high security cylinders, security cylinders or Yale KeyMark.)       |
| CKC2 | Master keys stamped with their keyset symbol and registry number. Change keys stamped with their keyset symbol. Cylinders stamped with their keyset symbol in a concealed location.  |
| CKC3 | Master keys stamped with their keyset symbol and registry number. Change keys stamped with their bitting. Cylinders stamped with their keyset symbol in a concealed location. (Not available for high security cylinders, security cylinders or Yale KeyMark.)       |

# Special Features



## Construction Master Keying

Construction Master Keying (CMK) provides the extra security needed in the transition from construction of a building or complex to completion. The construction master key operates all cylinders during construction. Upon completion of the construction phase, a special break out key is used in each cylinder to permanently void the construction master key. This action eliminates further use of the construction master or break out key.

### How it Works

Yale construction keying is accomplished by the placement of a ball bearing between the bottom pin and the top pin in one of the chambers. While the ball bearing is in place the construction master key will operate the cylinder. Removing the ball bearing, by use of the special break out key, voids the use of the construction master key. For all standard cylinders, the breakout key is rotated approximately 120 degrees either clockwise or counter-clockwise and the ball bearing is lost through a pre-drilled hole in the cylinder shell.

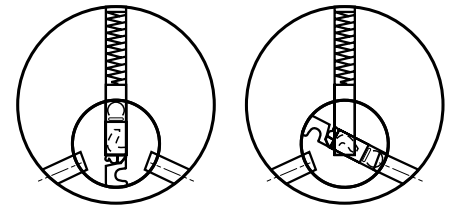

With CBOK inserted

Turning CBOK Releases Ball-Bearing

### SKD Caution

Unless otherwise specified, SKD sets will be construction master keyed. When construction master keying is established for SKD sets, Yale issues a separate SKD construction master keys and construction break out keys.

### Temporary Construction Cores

A more secure method of construction keying for interchangeable core hardware is the use of temporary construction cores. Yale recommends this method of construction keying for key systems using interchangeable core cylinders. Construction cores are furnished keyed alike to a combination unrelated to the permanent system's master key. When the building is turned over to the owner, the permanent cores are installed and the temporary construction cores are returned to Yale for credit.

### How to Order CMK

To order locksets and/or cylinders with the construction master key feature, the option code **CMK** should be indicated. i.e. 2153 x CMK. Construction master keying is not available on security, high security or Yale® KeyMark® cylinders.

The permanent master and change keys for the system are always packed and shipped separately, and the order must include the names and addresses of individuals to whom the construction, permanent master and change keys should be sent.

To order locksets and/or cylinders with temporary construction cores, specify "x Temp Core" when ordering. i.e. 2196 x Temp Core.

## Interchangeable Core

Yale offers interchangeable core cylinders which are recommended for virtually all types of keying systems, such as office buildings, hotels, schools, hospitals and universities. These cylinders have a 'self-contained' core which is removed from the housing by a control key. The core can be replaced or re-keyed without removing the hardware from the door or disassembling the lock. For conventional and security cylinders, Yale offers large format interchangeable cores which can be integrated with standard cylinder formats within the same key system. For Yale® KeyMark® systems, large format and small format cores are available and can be keyed within the same key system. Yale also offers small format cores and master keying with Best® keyways (see page 18).



To order interchangeable core cylinders with locksets, specify by cylinder or core model number. i.e. AUR8807FL x RH x **2196** x 626 or AU5407LN x RH x **1210** x 626. Unless otherwise specified, conventional fixed core cylinders will be provided as standard with locksets.

Large format cores are available construction master keyed, although temporary cores are recommended. To void the construction master key, the core must first be removed from the housing and then operated by the breakout key to remove the ball bearing.

# Special Features



## Bump Resistant

Bumping, also called "rapping," has been a known lock picking technique for more than 50 years. This technique uses a specially cut key, which when inserted into a cylinder and then hit with a mallet or tool, forces the key to interact with the pins. This motion allows a separation between the pins which creates a "shear" line and enables the key to be turned and the lock to be opened.

Conventional cylinders in both fixed and interchangeable core formats are available to be constructed to withstand bumping. These cylinders will contain a patent pending pinning component that is designed to resist bumping attacks while maintaining cylinder functionality. Bump resistant cylinders provide an added line of defense against unauthorized entry.

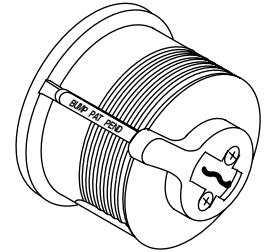

The bump resistant feature is available as an option for conventional mortise, rim and component cylinders with Yale® keyways. Fixed and interchangeable core cylinders can be provided in either in 6- or 7-pin lengths. This option is not available for security, high security or Yale® KeyMark® cylinders at this time.

### How to Order

To order with cylinders, specify option **BUMP**. (Cylinders will be marked with "BUMP PAT PEND" on the pin cover.)

Retrofit pins are also available to convert existing cylinders to bump resistant cylinders. Order by specifying **751-3**. A vial with a quantity of 300 pins is provided which will allow the retrofit of approximately 50 cylinders (6-pin). The vial easily fits into the SK-12 pin kit.

The Yale .019" pinning specification will change for cylinders with the BUMP option. Cylinders will be combined with a special 3 (.190") top (driver) pin in each chamber. Please see page 29 for Bump pinning specification.

## Hotel Function

Although not widely used in today's hotels, the hotel function lock still has several applications. In most cases, these locks are mixed with other lock functions on the same keying system.

When ordering a factory keyed lock system that includes Yale hotel function locks ALL cylinders in the system will need to be 7-pin in length with 7-pin keys. This applies even though the master key system will be 6-pin for expansion purposes.

### How it Works

The hotel function cylinder contains a blocking screw where the 7th pin is normally located. When the deadbolt is thrown on the hotel function lock, the blocking screw is engaged, thus blocking all change keys and master keys from operating the cylinder. Only the emergency key (EMK), which is cut on a shorter key blank with an undercut tip, will override the deadbolt thus operating the cylinder.

The change keys and master keys that operate the hotel function cylinder when the deadbolt is retracted are cut on key blanks with an undercut tip to bypass the blocking screw.

The hotel function lock may be operated by a grand master key or master key that also operates other cylinders in the system. Therefore, the other product must be 7-pin to accommodate these top master keys.

### Keyblanks

The following keyblanks are required when using hotel function locks/cylinders mixed with other function hardware:

- RN411** = Change key and top master keys that would operate hotel function cylinder
- RN117** = All other change keys and master keys in the system
- RN411S** = Emergency key
- FN118C** = Control key (if interchangeable core)

# Security and High Security



Security cylinders contain two independent locking mechanisms. The first is a traditional 6- or 7-pin tumbler mechanism with spool drivers for greater pick resistance. The second is an innovative rotating disc mechanism with sidebar engagement. The rotating discs are spring loaded and block the bottom of the keyway. Only a specially cut key will move the discs and allow entrance of the key. This key has special side bittings and must align all discs perfectly before the cylinder plug will rotate to open the lock. This cylinder is highly pick resistant because the unlocking mechanisms must be activated in two directions.

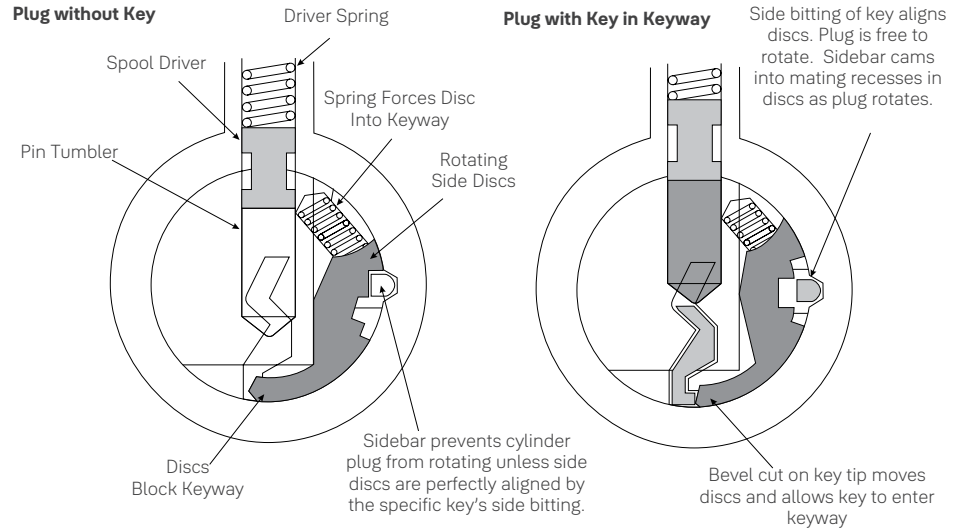

## UL High Security Cylinders

For applications that require a high security cylinder to meet the requirements of UL 437 for pick and drill resistance, Yale offers the U5153 mortise cylinder and the U5109 rim cylinder. These cylinders have a hardened stainless steel cylinder head and rotating plug face. They also incorporate all the features listed for the standard security cylinders. U5109 and U5153 cylinders use the 1766 cylinder collar, see page 23 for more information.

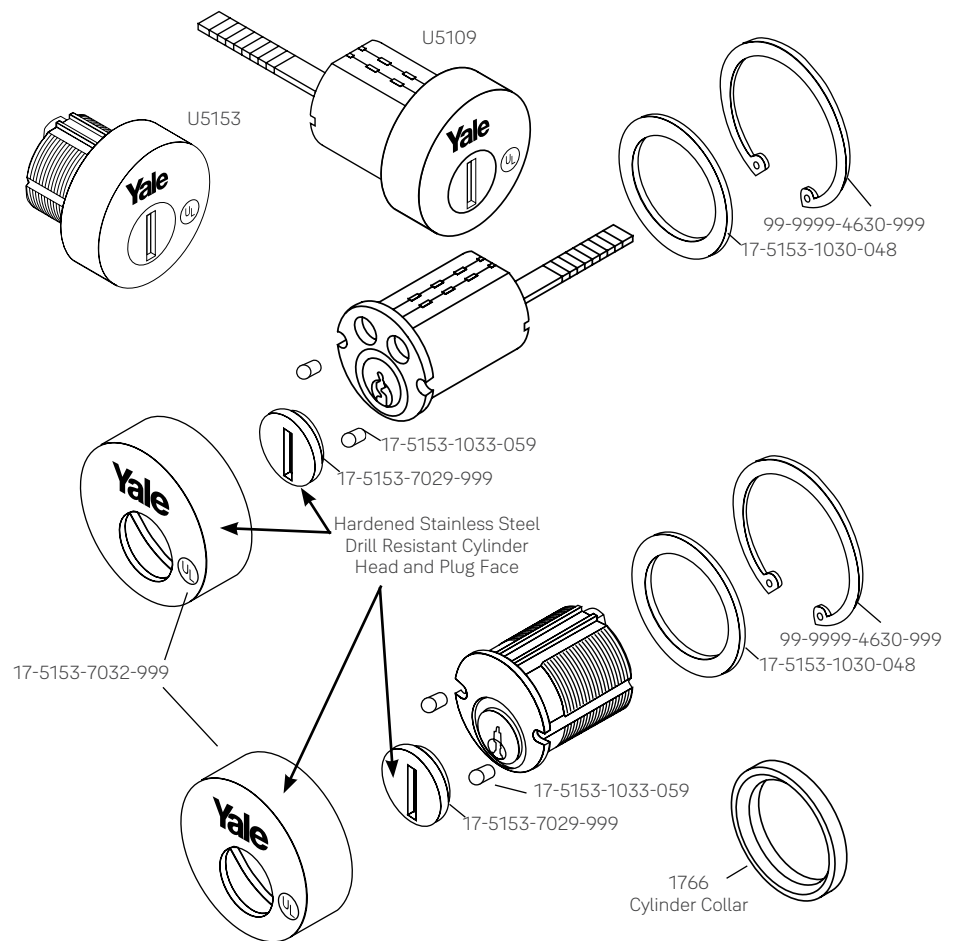

# Mortise Cylinders



## Fixed Core For Current Products

Includes standard, hotel, security and high security for mortise and auxiliary applications. Stock cylinders are furnished 1-1/8" length and 6-pin keyed random. Unless otherwise specified, stock cylinders ordered separately will be provided with cylinder collar 1765.156. If another collar size is required, specify when ordering. Refer to individual product sections for collar applications and sizes.



Mortise cylinders are provided standard with cams to operate Yale® mortise locks, optional cams are available (see page 22).

| Model # | Description  | 5-Pin   | Lengths                                   |  |   |   | Cam  |
|---------|--|---------|---|--|---|---|------|
|         |  |         | 6-Pin                                     |  | 7-Pin                                     |   |      |
| 2153    | Standard cylinder  | 1" (25) | 1-1/8" (29)<br>1-1/4" (32)<br>1-3/8" (35) | 1-1/2" (38)<br>1-5/8" (41)<br>1-3/4" (44)                | 1-1/4" (32)<br>1-3/8" (35)<br>1-1/2" (38) | 1-5/8" (41)<br>1-3/4" (44)                | 2160 |
| 2153S   | Standard cylinder for inside operation of 8817-2 and 8834-2 functions only | 1" (25) | 1-1/8" (29)<br>1-1/4" (32)<br>1-3/8" (35) | 1-1/2" (38)<br>1-5/8" (41)<br>1-3/4" (44)                | 1-1/4" (32)<br>1-3/8" (35)<br>1-1/2" (38) | 1-5/8" (41)<br>1-3/4" (44)                | 2130 |
| 2123    | Same as 2153 with long lengths for thicker doors                           | --      | 1-7/8" (48)<br>2-1/8" (54)<br>2-1/4" (57) | 2-3/8" (60)<br>2-1/2" (64)<br>2-5/8" (67)<br>2-3/4" (70) | 2-7/8" (73)<br>3" (76)<br>3-1/8" (79)     | 3-3/8" (86)<br>3-1/4" (83)<br>3-1/2" (89) | 2160 |
| 2123S   | Same as 2153S with long lengths for thicker doors                          | --      |   |  |   |   | 2130 |
| 2719*   | Standard cylinder for Hotel/Motel functions 8820, 8827, and 8832           | --      | 1-3/8" (35)                               |  | --  |   | 2160 |
| S2053S  | Thumbturn cylinder for inside operation of 8834 function                   | 1" (25) | 1-1/8" (29)                               |  | --  |   | 2130 |
| S2053   | Thumbturn operated cylinder to replace key operated cylinder               | 1" (25) | 1-1/8" (29)                               |  | --  |   | 2160 |
| 1108    | Dummy mortise cylinder   | 1" (25) | 1-1/8" (29)<br>1-1/4" (32)<br>1-3/8" (35) | 1-1/2" (38)<br>1-5/8" (41)<br>1-3/4" (44)                | 1-1/4" (32)<br>1-3/8" (35)<br>1-1/2" (38) | 1-5/8" (41)<br>1-3/4" (44)                | N/A  |
| 5153    | Security cylinder  | --      | 1-1/8" (29) 1-1/4" (32)                   |  | 1-1/4" (32)                               |   | 2160 |
| 5153S   | Security cylinder for inside operation of 8817-2 and 8834-2 functions only | --      | 1-1/8" (29) 1-1/4" (32)                   |  | 1-1/4" (32)                               |   | 2130 |
| 5719*   | Security cylinder for Hotel/Motel functions 8820, 8827, and 8832           | --      | 1-3/8" (35)                               |  | --  |   | 2160 |
| U5153   | High security cylinder   | --      | 1-1/8" (29) 1-1/4" (32)                   |  | 1-1/4" (32)                               |   | 2160 |
| U5719*  | High security cylinder for Hotel/Motel functions 8820, 8827, and 8832      | --      | 1-3/8" (35)                               |  | --  |   | 2160 |
| 2553^   | Schlage® "C" keyway cylinder 0-bitted or keyed random                      | --      | 1-1/8" (29)                               |  | --  |   | 2160 |

\*Cylinders are 6-pin for master keying expansion purposes. Locksets and housings will be 7-pin in length to accommodate top level master keys. See page 6 for more information.

^Available in 606, 612, 613 and 626 finishes only.

Dimensions are shown in inches (millimeters)





# Mortise Cylinders

## Fixed Core For Obsolete Products

The following fixed core cylinders are available for obsolete Yale® mortise products.

| Model # | Description   | Lengths |   |   | Cam  |
|---------|---|---------|---|---|------|
|         |   | 5-Pin   | 6-Pin   | 7-Pin   |      |
| 1152    | Standard cylinder for obsolete cast iron mortise locks      | 1" (25) | 1-1/8" (29) 1-1/2" (38)<br>1-1/4" (32) 1-5/8" (41)<br>1-3/8" (35) 1-3/4" (44) | 1-1/4" (32) 1-5/8" (41)<br>1-3/8" (35) 1-3/4" (44)<br>1-1/2" (38) | 1161 |
| 1719*   | Standard cylinder for obsolete Hotel/Motel cast iron locks  | --      | 1-3/8" (35)   | --  | 1160 |
| 5152    | Security cylinder for obsolete cast iron mortise locks      | --      | 1-1/8" (29) 1-1/4" (32)   | 1-1/4" (32)   | 1161 |
| U5152   | High security cylinder for obsolete cast iron mortise locks | --      | 1-1/8" (29) 1-1/4" (32)   | 1-1/4" (32)   | 1161 |

\*Cylinders are 6-pin for master keying expansion purposes. Locksets and housings will be 7-pin in length to accommodate top level master keys. See page 6 for more information.

## Dimensions

### Standard Cylinders

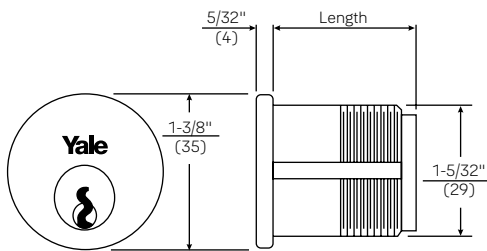

### Thumbturn Cylinders

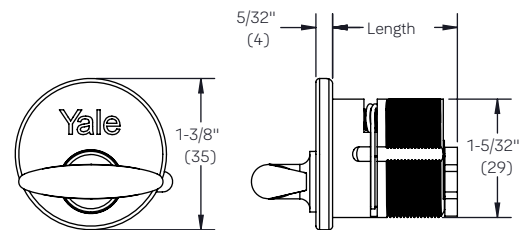

### Security Cylinders

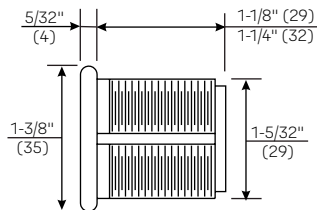

### High Security Cylinders

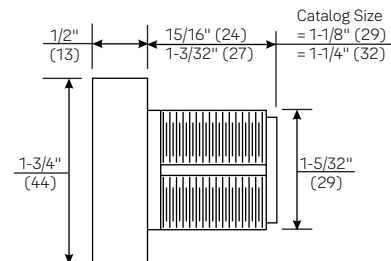

Dimensions are shown in inches (millimeters)

# Mortise Cylinders



## Large Format Interchangeable Core (LFIC) For Current Products

Includes standard, hotel, security and high security large format interchangeable core for mortise and auxiliary applications. When ordering interchangeable core cylinders or cores only, control keys are not furnished. If control keys are required, they must be specified.



| Model Numbers     |           |              | Description  | Lengths                         |                       | Cam  |
|-------------------|-----------|--------------|--|---------------------------------|-----------------------|------|
| Complete Cylinder | Core Only | Housing Only |  | 6-Pin                           | 7-Pin                 |      |
| 2196              | 1210      | 2221         | Standard cylinder  | 1-1/2" (38) 1-3/4" (44) 2" (51) | --                    | 2160 |
| 2196S             | 1210      | 2214S        | Standard cylinder for inside operation of 8817-2 and 8834-2 functions only | 1-1/2" (38)                     | --                    | 2130 |
| 2196H*            | 1210H     | 2213         | Standard cylinder for Hotel/Motel functions 8820, 8827, and 8832           | 1-11/16" (43)                   | --                    | 2160 |
| 2197              | 1220      | 2213         | Standard cylinder  | --                              | 1-11/16" (43) 2" (51) | 2160 |
| 2197S             | 1220      | 2217S        | Standard cylinder for inside operation of 8817-2 and 8834-2 functions only | --                              | 1-11/16" (43)         | 2130 |
| 5196              | 5210      | 2221         | Security cylinder  | 1-1/2" (38) 1-3/4" (44) 2" (51) | --                    | 2160 |
| 5196S             | 5210      | 2214S        | Security cylinder for inside operation of 8817-2 and 8834-2 functions only | 1-1/2" (38)                     | --                    | 2130 |
| 5196H*            | 5210H     | 2213         | Security cylinder for Hotel/Motel functions 8820, 8827, and 8832           | 1-11/16" (43)                   | --                    | 2160 |
| 5197              | 5220      | 2213         | Security cylinder  | --                              | 1-11/16" (43) 2" (51) | 2160 |
| 5197S             | 5220      | 2217S        | Security cylinder for inside operation of 8817-2 and 8834-2 functions only | --                              | 1-11/16" (43)         | 2130 |

\*Cores are 6-pin for master keying expansion purposes. Locksets and housings will be 7-pin in length to accommodate top level master keys. See page 6 for more information.

## Large Format Interchangeable Core (LFIC) For Obsolete Products

The following LFIC cylinders are available for obsolete or discontinued Yale® mortise products.

| Model Numbers     |           |              | Description  | Lengths       |               | Cam   |
|-------------------|-----------|--------------|--|---------------|---------------|-------|
| Complete Cylinder | Core Only | Housing Only |  | 6-Pin         | 7-Pin         |       |
| 1194              | 1210      | 1214         | Standard cylinder for obsolete cast iron mortise locks     | 1-1/2" (38)   | --            | 1160E |
| 1194              | 1220      | 1214H        | Standard cylinder for obsolete cast iron mortise locks     | --            | 1-11/16" (43) | 1160E |
| 1194H*            | 1210H     | 1214H        | Standard cylinder for obsolete Hotel/Motel cast iron locks | 1-11/16" (43) | --            | 1160E |
| 1196              | 1210      | 1221         | Standard cylinder for discontinued 310 series deadlocks    | 1-1/2" (38)   | --            | 1160R |
| 1196              | 1220      | 1213         | Standard cylinder for discontinued 310 series deadlocks    | --            | 1-11/16" (43) | 1160R |
| 1196H*            | 1210H     | 1213         | Standard cylinder for obsolete hotel 310 series deadlocks  | 1-11/16" (43) | --            | 1160R |
| 5194              | 5210      | 1214         | Security cylinder for obsolete cast iron mortise locks     | 1-1/2" (38)   | --            | 1160E |
| 5194              | 5220      | 1214H        | Security cylinder for obsolete cast iron mortise locks     | --            | 1-11/16" (43) | 1160E |

\*Cores are 6-pin for master keying expansion purposes. Locksets and housings will be 7-pin in length to accommodate top level master keys. See page 6 for more information.

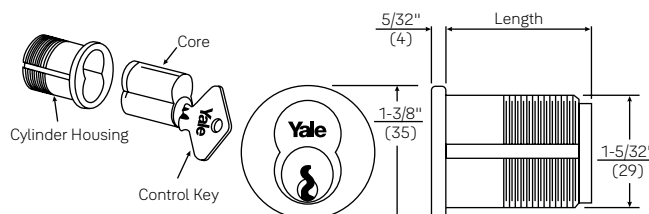

Dimensions are shown in inches (millimeters)

# Rim Cylinders



## Fixed Core For Current Products

Includes standard, hotel, security and high security for rim lock and exit device trim applications. When ordered with products, cylinders are provided with applicable tailpiece and collar. Cylinders ordered separately are provided with backplate and screws standard. Tailpiece must be specified. If required, collar must be specified. Refer to individual product sections for collar applications and sizes.



| Model #           | Description   | No. of Active Pins | Dim A            | Dim B           | Dim C<br>Tailpiece Model Numbers |                  |
|-------------------|---|--------------------|------------------|-----------------|----------------------------------|------------------|
|                   |   |                    |                  |                 | #1145                            | #1147            |
| 1109              | Standard cylinder                                       | 5                  | 1-1/32"<br>(26)  | 15/16"<br>(24)  | 2-9/16"<br>(65)                  | 3-7/16"<br>(87)  |
|                   |   | 6                  | 1-7/32"<br>(31)  | 1-3/32"<br>(28) | 2-3/4"<br>(70)                   | 3-5/8"<br>(92)   |
|                   |   | 7                  | 1-13/32"<br>(36) | 1-1/4"<br>(32)  | 2-15/16"<br>(75)                 | 3-13/16"<br>(97) |
| 5109              | Security cylinder                                       | 6                  | 1-7/32"<br>(31)  | 1-3/32"<br>(28) | 2-3/4"<br>(70)                   | 3-5/8"<br>(92)   |
|                   |   | 7                  | 1-13/32"<br>(36) | 1-1/4"<br>(32)  | 2-15/16"<br>(75)                 | 3-13/16"<br>(97) |
| 2109 <sup>^</sup> | Schlage® "C" keyway cylinder - 0-bitted or keyed random | 6                  | 1-7/32"<br>(31)  | 1-3/32"<br>(28) | 2-3/4"<br>(70)                   | 3-5/8"<br>(92)   |

<sup>^</sup>Available in 606, 612, 613 and 626 finishes only.

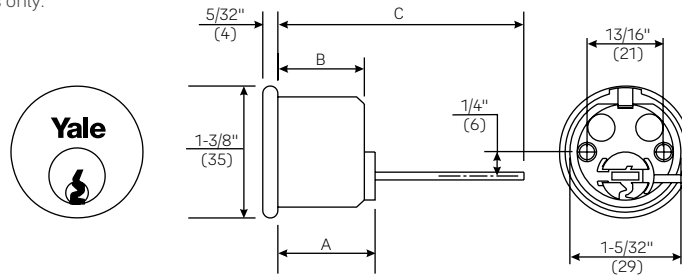

## Fixed Core For Hotel/Motel Function Products

| Model # | Description                                | No. of Active Pins | Dim A          | Dim B           | Dim C<br>Tailpiece Model Numbers |             |
|---------|--|--------------------|----------------|-----------------|----------------------------------|-------------|
|         |  |                    |                |                 | #1145                            | #1147       |
| 1179*   | Standard cylinder for Hotel/Motel function | 6                  | 1-5/8"<br>(41) | 1-3/32"<br>(28) | 3-3/16"<br>(81)                  | 4"<br>(102) |

\*Cylinders are 6-pin for master keying expansion purposes. Locksets and housings will be 7-pin in length to accommodate top level master keys. See page 6 for more information.

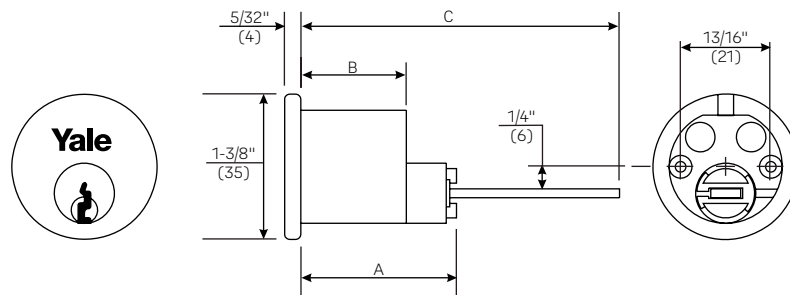

Dimensions are shown in inches (millimeters)

# Rim Cylinders



## With Lazy Cam Operation

| Model # | Description                               | No. of Active Pins | Dim A         | Dim B       | Dim C Tailpiece Model Numbers |
|---------|---|--------------------|---------------|-------------|-------------------------------|
| 1709    | Standard cylinder with lazy cam operation | 5 or 6             | 1-11/32" (34) | 31/32" (25) | 3-3/16" (81)                  |
|         |   | 7                  | 1-1/2" (38)   | 1-1/8" (29) | 3-7/32" (82)                  |

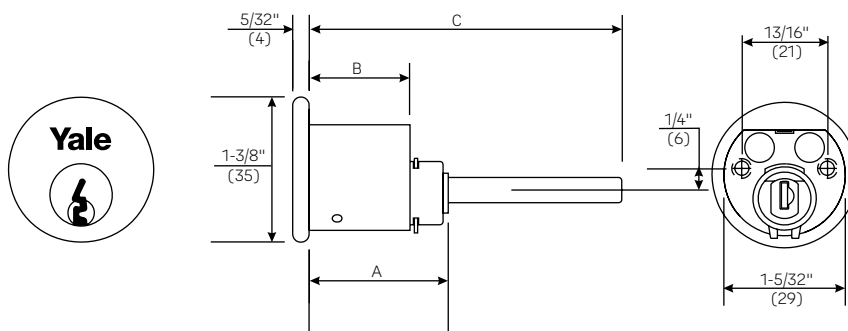

## Fixed Core High Security

| Model # | Description            | No. of Active Pins | Dim A        | Dim B        | Dim C Tailpiece Lengths |              |
|---------|------------------------|--------------------|--------------|--------------|-------------------------|--------------|
|         |                        |                    |              |              | #1145                   | #1147        |
| U5109   | High Security Cylinder | 6                  | 1-1/16" (27) | 15/16" (24)  | 2-7/16" (62)            | 3-5/8" (84)  |
|         |                        | 7                  | 1-1/8" (29)  | 1-1/16" (27) | 2-5/8" (67)             | 3-1/16" (89) |

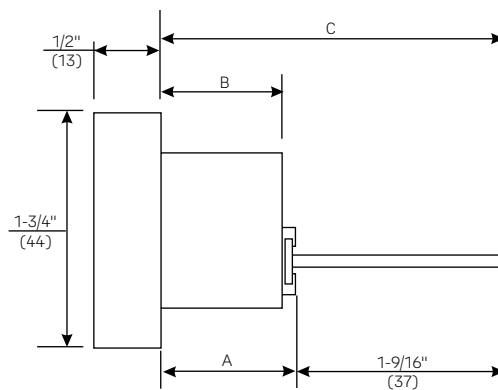

Dimensions are shown in inches (millimeters)

# Rim Cylinders



## Large Format Interchangeable Core (LFIC) For Current Products

Includes standard, hotel, security and high security large format interchangeable core for rim lock and exit device trim applications. When ordering interchangeable core cylinders or cores only, control keys are not furnished. If control keys are required, they must be specified.



| Model Numbers     |           |              | Description       | No. of Active Pins | Dim A        | Dim B        | Dim C Tailpiece Model Numbers |               |
|-------------------|-----------|--------------|-------------------|--------------------|--------------|--------------|-------------------------------|---------------|
| Complete Cylinder | Core Only | Housing Only |                   |                    |              |              | #1145                         | #1147         |
| 1193              | 1210      | 1212         | Standard cylinder | 6                  | 1-7/16" (37) | 1-3/8" (27)  | 2-15/16" (75)                 | 3-3/4" (95)   |
| 1193              | 1220      | 1212B        | Standard cylinder | 7                  | 1-5/8" (41)  | 1-9/16" (40) | 3-1/8" (79)                   | 4-5/16" (110) |
| 5193              | 5210      | 1212         | Security cylinder | 6                  | 1-7/16" (37) | 1-3/8" (35)  | 2-15/16" (75)                 | 3-3/4" (95)   |
| 5193              | 5220      | 1212B        | Security cylinder | 7                  | 1-5/8" (41)  | 1-9/16" (40) | 3-1/8" (79)                   | 4-5/16" (110) |

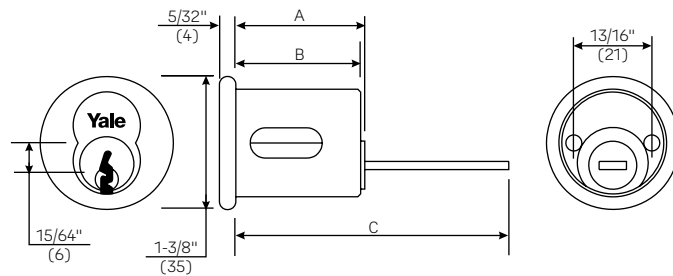

## Large Format Interchangeable Core (LFIC) With Lazy Cam Operation

| Model Numbers     |           |                  | Description                               | No. of Active Pins | Dim A       | Dim B       | Dim C       |
|-------------------|-----------|------------------|---|--------------------|-------------|-------------|-------------|
| Complete Cylinder | Core Only | Housing Assembly |   |                    |             |             |             |
| 1193L             | 1210      | *                | Standard cylinder with lazy cam operation | 6                  | 1-3/4" (44) | 1-3/8" (35) | 3-1/2" (89) |

\*Uses 1212 housing with lazy cam. Specify by part number 10-1193-0044 x Finish

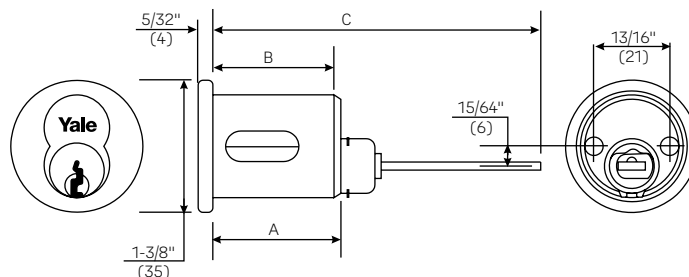

Dimensions are shown in inches (millimeters)

# Component Cylinders



Includes standard and security for cylindrical lock, exit trim and deadbolt applications.

## Knob Cylinders

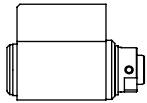

## Lever Cylinders

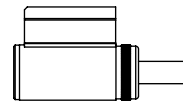
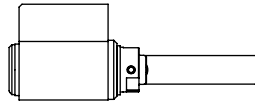

## Conventional

| Model #   | No. of Pins | Tailpiece Part Number (Length)* | Applications  |
|---|-------------|---------------------------------|---|
| <b>Cylindrical Locks &amp; Exit Device Trim</b> |             |                                 |   |
| 1801  | 6           | None                            | Standard for 5300^ & 5400^ series knob locks and 540F series trim.  |
| 1801A   | 7           | None                            | Standard for 5400^ series knob locks and 540F series trim.  |
| 1802  | 6           | 14-5407-1039-048 (1.69")        | Standard for 5400LN, 6400LN & inTouch^ lever locks and 440F, 540F & 580F series trims.<br>Optional for 4700LN & 5300LN series lever locks.<br>Sleeve 14-5305-9078-999 required for use with 4700LN, 5300LN, inTouch and 440F trims. |
| 1802A   | 7           | 14-5407-1049-048 (1.50")        | Standard for 5400LN & 6400LN series lever locks and 540F & 580F series trims.   |
| 1802L   | 6           | 14-5305-1060-048 (2.00")        | Optional for 5300LN series locks used with 2" to 2-1/4" thick doors.<br>Sleeve 14-5305-9078-999 required.   |
| 1802S   | 6           | 14-5417-1024-048 (.940")        | Standard for 5417LN & 6417LN function inside lever locks  |
| 1803-54L  | 6           | 17-1803-1005 (.692")            | Standard for Corbin Russwin CL3100 (YC) & Sargent 11 Line (YC-) series lever locks.<br>Optional for 4300LN, 4600LN & 4800LN^ series lever locks.  |
| 1803A-54L                                       | 7           | 17-1803-1004 (.536")            | Standard for Corbin Russwin CL3100 (YC7), Sargent 11 Line (YC-7P-) series lever locks.  |
| 1803-54K  | 6           | 17-1803-1005 (.692")            | Standard for 5400CK series knob locks and YH Collection lever locks.  |
| 1803-53L  | 6           | 17-1803-1011 (1.700")           | Standard for nexTouch™ cylindrical lever locks.<br>Optional for inTouch^ lever locks.<br>Sleeve 14-1803-9001-999 required.  |
| 1803-47L  | 6           | 17-1803-1012 (1.930")           | Standard for 4700LN & 5300LN series lever locks. Optional for 440F series trim.<br>Sleeve 14-1803-9001-999 required.  |
| 1803-46L  | 6           | 17-1803-1006 (1.106")           | Standard for Corbin Russwin CLX3300 (YC) & SARGENT 10X Line (YC-) series cylindrical locks, 1-3/8" – 2" doors.  |
| 1803-46LL                                       | 6           | 17-1803-1008 (1.330")           | Standard for Corbin Russwin CLX3300 (YC) & SARGENT 10X Line (YC-) series cylindrical locks, 2-1/4" doors.   |
| 1803A-46L                                       | 7           | 17-1803-1007 (.950")            | Standard for Corbin Russwin CLX3300 (YC7) & SARGENT 10X Line (YC-7P-) series cylindrical locks, 1-3/8" – 2" doors.  |
| 1803A-46LL                                      | 7           | 17-1803-1009 (1.174")           | Standard for Corbin Russwin CLX3300 (YC7) & SARGENT 10X Line (YC-7P-) series cylindrical locks, 2-1/4" doors.   |
| 1803-46K  | 6           | 17-1803-1006 (1.106")           | Optional for 4600 series knob locks.  |
| 1805  | 6           | S13-0919-999 (1.161")           | Standard for 4600 & 4700^ series knob locks.  |
| 1806  | 6           | S05-0215-999 (.844")            | Standard for 4600LN series lever locks.   |
| 1812  | 6           | 14-4307-1000-048 (.614")        | Standard for 4300^, 4300LN & 4800LN^ series knob/lever locks.   |
| <b>Deadbolts</b>                                |             |                                 |   |
| 1803-134S                                       | 6           | 17-1803-1013 (2.30")            | Standard for YH Collection deadbolt used with interconnected lock (non-face removable).<br>Optional for D Series deadbolts, single cylinder functions.  |
| 1803-134D                                       | 6           | 17-1803-1014 (.87")             | Optional for D Series deadbolts, double cylinder functions.   |
| 1807  | 6           | S13-0880 (2.134")               | Standard for D series deadbolts, single cylinder functions.   |
| 1808  | 6           | S13-0878 (.812")                | Standard for D series deadbolts, double cylinder functions.   |
| 1814  | 6           | 14-3721-1007 (1.94")            | Standard for 4800LN^ series deadbolt.   |

\*Tailpiece length specified for 1-3/4" door. For other door thicknesses, contact technical support.

^ Lockset series obsolete.

# Component Cylinders



## Security

| Model #   | No. of Pins | Tailpiece Part Number (Length)* | Applications   |
|---|-------------|---------------------------------|--|
| <b>Cylindrical Locks &amp; Exit Device Trim</b> |             |                                 |  |
| 5801C   | 6           | None                            | Optional for 5300^ & 5400^ series knob locks and 540F series trim.   |
| 5801A   | 7           | None                            | Optional for 5400^ series knob locks and 540F series trim.   |
| 5802  | 6           | 14-5407-1039-048 (1.69")        | Optional for 4700LN, 5300LN, 5400LN, 6400LN & inTouch*^ lever locks and 440F, 540F & 580F series trims.<br>Sleeve 14-5305-9078-999 required for use with 4700LN, 5300LN, inTouch and 440F trims. |
| 5802A   | 7           | 14-5407-1049-048 (1.50")        | Optional for 5400LN & 6400LN series lever locks and 540F & 580F series trims.  |
| 5812  | 6           | 14-4307-1000-048 (.614")        | Optional for 4300^, 4300LN & 4800LN^ series knob/lever locks.  |
| 5803-54L  | 6           | 17-1803-1005 (.692")            | Optional for Corbin Russwin CL3100 (YC) & Sargent 11 Line (YC-) series lever locks. Optional for 4300LN, 4600LN & 4800LN^ series lever locks.  |
| 5803A-54L                                       | 7           | 17-1803-1004 (.536")            | Optional for Corbin Russwin CL3100 (YC7), Sargent 11 Line (YC-7P-) series lever locks.   |
| 5803-54K  | 6           | 17-1803-1005 (.692")            | Optional for 5400CK series knob locks and YH Collection lever locks.   |
| 5803-53L  | 6           | 17-1803-1011 (1.700")           | Optional for nexTouch™ cylindrical and inTouch*^ lever locks.<br>Sleeve 14-1803-9001-999 required.   |
| 5803-47L  | 6           | 17-1803-1012 (1.930")           | Standard for 4700LN & 5300LN series lever locks. Optional for 440F series trim.<br>Sleeve 14-1803-9001-999 required.   |
| 5803-46L  | 6           | 17-1803-1006 (1.106")           | Standard for Corbin Russwin CLX3300 (YC) & SARGENT 10X Line (YC-) series cylindrical locks, 1-3/8" – 2" doors.   |
| 5803-46LL                                       | 6           | 17-1803-1008 (1.330")           | Standard for Corbin Russwin CLX3300 (YC) & SARGENT 10X Line (YC-) series cylindrical locks, 2-1/4" doors.  |
| 5803A-46L                                       | 7           | 17-1803-1007 (.950")            | Standard for Corbin Russwin CLX3300 (YC7) & SARGENT 10X Line (YC-7P-) series cylindrical locks, 1-3/8" – 2" doors.   |
| 5803A-46LL                                      | 7           | 17-1803-1009 (1.174")           | Standard for Corbin Russwin CLX3300 (YC7) & SARGENT 10X Line (YC-7P-) series cylindrical locks, 2-1/4" doors.  |
| 5803-46K  | 6           | 17-1803-1006 (1.106")           | Optional for 4600 series knob locks.   |
| <b>Deadbolts</b>                                |             |                                 |  |
| 5814  | 6           | 14-3721-1007 (1.94")            | Optional for 4800LN^ series deadbolt.  |
| 5803-134S                                       | 6           | 17-1803-1013 (2.30")            | Optional for YH Collection deadbolt used with interconnected lock (non-face removable).<br>Optional for D Series deadbolts, single cylinder functions.   |
| 5803-134D                                       | 6           | 17-1803-1014 (.87")             | Optional for D Series deadbolts, double cylinder functions.  |

\*Tailpiece length specified for 1-3/4" door. For other door thicknesses, contact technical support.

^ Lockset series obsolete.

# Component Cylinders



## Other Manufacturer's Keyway

| Model #   | No. of Pins | Tailpiece Part Number (Length)*  | Applications   |
|---|-------------|--|--|
| <b>Cylindrical Locks &amp; Exit Device Trim</b> |             |  |  |
| 2801  | 6           | None   | Schlage® "C" keyway for 5300^ & 5400^ series locks and 540F series trim.   |
| 2802  | 6           | 14-5407-1039-048 (1.69")   | Schlage® "C" keyway for 5300LN, 5400LN, 6400LN & inTouch®^ series lever locks and 440F, 540F & 580F series trims.<br>Sleeve 14-5305-9078-999 required for use with 4700LN, 5300LN, inTouch and 440F trims. |
| 2805  | 6           | S13-0919-999 (1.161")  | Schlage® "C" keyway for 4600 & 4700^ series knob locks.  |
| 2806  | 6           | S05-0215-999 (.844")   | Schlage® "C" keyway for 4600LN series lever locks.   |
| 2812  | 6           | 14-4307-1000-048 (.614")   | Schlage® "C" keyway for 4300^, 4300LN & 4800LN^ series knob/lever locks.   |
| 2803-54L  | 6           | 17-1803-1005 (.692")   | Optional for Corbin Russwin CL3100 (YC) & Sargent 11 Line (YC-) series lever locks. Optional for 4300LN, 4600LN & 4800LN^ series lever locks.  |
| 2803-54K  | 6           | 17-1803-1005 (.692")   | Schlage® "C" keyway for 5400CK series knob locks and YH Collection lever locks.  |
| 2803-53L  | 6           | 17-1803-1011 (1.700")  | Schlage® "C" keyway for nexTouch™ cylindrical lever locks. Optional for inTouch®^ lever locks.<br>Sleeve 14-1803-9001-999 required.  |
| 2803-47L  | 6           | 17-1803-1012 (1.930")  | Standard for 4700LN & 5300LN series lever locks. Optional for 440F series trim.<br>Sleeve 14-1803-9001-999 required.   |
| 2803-46L  | 6           | 17-1803-1006 (1.106")  | Optional for Corbin Russwin CLX3300 (YC) & SARGENT 10X Line (YC-) series cylindrical locks, 1-3/8" – 2" doors.   |
| 2803-46K  | 6           | 17-1803-1006 (1.106")  | Optional for 4600 series knob locks.   |
| 3804  | 6           | 14-5407-0460-048 (1.70")   | Other manufacturer's keyway for 4700LN, 5300LN, 5400LN, 6400LN & inTouch®^ lever locks and 440F, 540F & 580F series trims.   |
| 3805  | 6           | Contact technical support  | Other manufacturer's keyway for 4700^ series knob locks.   |
| 3806  | 6           | Tailpieces from pack included with cylinder (.925" for lever lock & .690" for knob lock) | Other manufacturer's keyway for 4600 & 4600LN series knob/lever locks.   |
| 3803-54L  | 6           | 17-1803-1005 (.692")   | Optional for Corbin Russwin CL3100 (YC) & Sargent 11 Line (YC-) series lever locks. Optional for 4300LN, 4600LN & 4800LN^ series lever locks.  |
| 3803-54K  | 6           | 17-1803-1005 (.692")   | Other manufacturer's keyway for 5400CK series knob locks and YH Collection lever locks.  |
| 3803-53L  | 6           | 17-1803-1011 (1.700")  | Other manufacturer's keyway for nexTouch™ cylindrical lever locks.<br>Optional for inTouch®^ lever locks.<br>Sleeve 14-1803-9001-999 required.   |
| 3803-47L  | 6           | 17-1803-1012 (1.930")  | Standard for 4700LN & 5300LN series lever locks. Optional for 440F series trim.<br>Sleeve 14-1803-9001-999 required.   |
| 3803-46L  | 6           | 17-1803-1006 (1.106")  | Optional for Corbin Russwin CLX3300 (YC) & SARGENT 10X Line (YC-) series cylindrical locks, 1-3/8" – 2" doors.   |
| 3803-46K  | 6           | 17-1803-1006 (1.106")  | Optional for 4600 series knob locks.   |
| 100CV1  | 6           | Contact technical support  | Arrow AR keyway for nexTouch™ cylindrical lever locks.   |

\*Tailpiece length specified for 1-3/4" door. For other door thicknesses, contact technical support.

^ Lockset series obsolete.

Notes:

- Schlage® C keyway cylinders (28XX) are available keyed random or 0-bitted.
- Other manufacturer's keyway cylinders (38XX) are only available keyed random, please specify keyway. Available keyways are Sargent LA, Schlage® E, Corbin Russwin L4, Corbin® 60 and Russwin® D1.



# Component Cylinders



## Other Manufacturer's Keyway (Cont.)

| Model #          | No. of Pins | Tailpiece Part Number (Length)*  | Applications   |
|------------------|-------------|--|--|
| <b>Deadbolts</b> |             |  |  |
| 2807             | 6           | S13-0880 (2.134")  | Schlage® "C" keyway for D series deadbolts, single cylinder functions  |
| 2808             | 6           | S13-0878 (.812")   | Schlage® "C" keyway for D series deadbolts, double cylinder functions  |
| 2814             | 6           | 14-3721-1007 (1.94")   | Schlage® "C" keyway for 4800LN^ series deadbolt  |
| 2803-134S        | 6           | 17-1803-1013 (2.30")   | Schlage® "C" keyway for YH Collection deadbolt used with interconnected lock (non-face removable). Optional for D Series deadbolts, single cylinder functions.         |
| 2803-134D        | 6           | 17-1803-1014 (.87")  | Schlage® "C" keyway for D Series deadbolts, double cylinder functions  |
| 3806             | 6           | Tailpieces from the pack included with cylinder (2.130" for single cylinder function & .950" for double cylinder function) | Other manufacturer's keyway for D series deadbolts   |
| 3803-134S        | 6           | 17-1803-1013 (2.30")   | Other manufacturer's keyway for YH Collection Deadbolt used with interconnected lock (non-face removable). Optional for D Series deadbolts, single cylinder functions. |
| 3803-134D        | 6           | 17-1803-1014 (.87")  | Other manufacturer's keyway for D Series deadbolts, double cylinder functions  |

\*Tailpiece length specified for 1-3/4" door. For other door thicknesses, contact technical support.

^Lockset series obsolete.

Notes:

- Schlage® C keyway cylinders (28XX) are available keyed random or 0-bitted.
- Other manufacturer's keyway cylinders (38XX) are only available keyed random, please specify keyway. Available keyways are Sargent LA, Schlage® E, Corbin Russwin L4, Corbin® 60 and Russwin® D1.

# Interchangeable Core



## Large Format

Large format cores are interchangeable with Yale® mortise locks, cylindrical locks and exit device trims and can be keyed in conjunction with standard cylinders. When ordering cores only, control keys are not furnished. If control keys are required, they must be specified.



| Model # | Description   | Number of Active Pins |
|---------|---|-----------------------|
| 1210    | Standard large format core  | 6                     |
| 1220    | Standard large format core  | 7                     |
| 1210H*  | Standard large format core for Hotel/Motel functions 8820, 8827, and 8832 | 6                     |
| 5210    | Security large format core  | 6                     |
| 5220    | Security large format core  | 7                     |
| 5210H*  | Security large format core for Hotel/Motel functions 8820, 8827, and 8832 | 6                     |

\*Cores are 6-pin for master keying expansion purposes, but locksets and housing must be 7-pin in length to accommodate top level master keys. See page 6 for more information.

## Small Format

Yale offers SFIC cores in Yale® KeyMark® (see separate catalog for more information) or Best® keyways A, B, C, D, E, F, G, H, J, K, L and M.



Best® keyway cores can be provided random keyed, master keyed or uncombined. Yale will provide master keying to a new key system only. Systems can be provided using the A2 or A4 pinning specification and can not be tied into any conventional or Yale KeyMark key systems.

All cylindrical lock small format preparations accept either 6- or 7-pin cores. For mortise and rim housings, see chart below. When ordering cores only, control keys are not furnished. If control keys are required, they must be specified.

| Model Numbers     |           |              | Description  | Lengths                    |                            | Cam/Tailpiece |
|-------------------|-----------|--------------|--|----------------------------|----------------------------|---------------|
| Complete Cylinder | Core Only | Housing Only |  | 6-Pin                      | 7-Pin                      |               |
| A620              | A600      | K660         | Best® keyway mortise cylinder                          | 1-1/4" (32)<br>1-3/8" (35) | 1-3/8" (35)<br>1-3/4" (44) | KC1*          |
| A630              | A600      | K670         | Best® keyway tapered mortise cylinder                  | 1-1/4" (32)<br>1-3/8" (35) | 1-3/8" (35)                | KC1           |
| A640              | A600      | K680         | Best® keyway rim cylinder                              | 1-1/4" (32)<br>1-3/8" (35) | 1-3/8" (35)                | KT1           |
| —                 | K925      | —            | Disposable thumbturn only, used with 6- or 7-pin       | —                          | —                          | —             |
| —                 | K926      | —            | Temporary construction core only, used with 6-or 7-pin | —                          | —                          | —             |

\*Refer to the Yale® KeyMark® catalog page 14 for optional cams and page 18 for more information on SFIC construction core program.

For 1-3/4" housing, the cam is riveted; therefore only KC1 is available.

For 6-pin, 1-1/4" will be supplied unless otherwise specified.



# Key Blanks

Yale offers .51" pin tumbler key blanks in several lengths and bow styles. All key blanks are supplied in nickel silver and are available in all .51" key sections. See page 21 for key sections.

Keys are available with special stamping, i.e. Do Not Duplicate. Custom die stamps are also available upon request. Contact customer service for more information.

## How To Order

| Bow Style | Key Blank Material | Basic Model Number  | Key Section |
|-----------|--------------------|---|-------------|
| R         | N                  | 11  | GA          |
| See Below | Nickel Silver      | .51" Pin Tumbler<br>9 = 4 Pin<br>8 = 5 Pin<br>11 = 6 Pin<br>117 = 7 Pin<br>118 = 8 Pin<br>411 = 7-1/2 Pin<br>411S = 6 Pin | See page 21 |

## Bow Styles

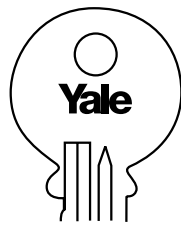

**R**

Standard bow furnished for all conventional keys.

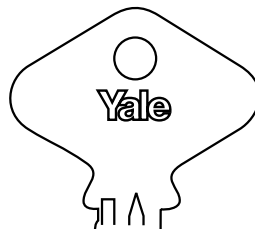

**F**

Standard bow furnished for control keys, optional for conventional keys.

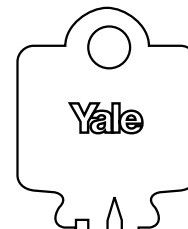

**A**

Standard bow furnished for security and high security keys, optional for conventional keys.

## .51" Pin Tumbler Key Blanks

| Model Number | Length |
|--------------|--------|
| RN9.....     | 4-pin  |
| RN8.....     | 5-pin  |
| RN11.....    | 6-pin  |
| RN117.....   | 7-pin  |

| Model Number | Length |
|--------------|--------|
| FN8.....     | 5-pin  |
| FN11.....    | 6-pin  |
| FN117.....   | 7-pin  |
| FN118.....   | 8-pin  |

| Model Number | Length |
|--------------|--------|
| *AN8.....    | 5-pin  |
| *AN11.....   | 6-pin  |
| AN117.....   | 7-pin  |

\*Standard keybow for high security key blanks, letter of authorization required. Side cuts are factory machined.

# Key Blanks



## LFIC Control Key Blanks

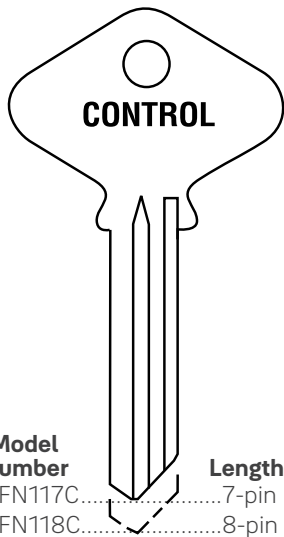

## Hotel/Motel Key Blanks

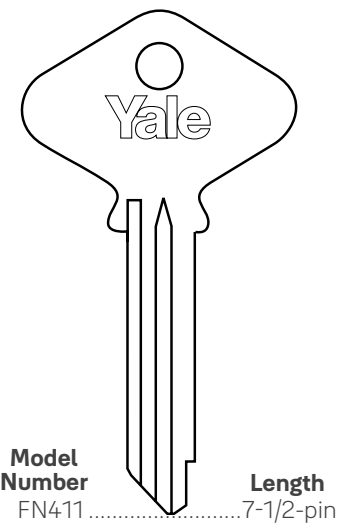
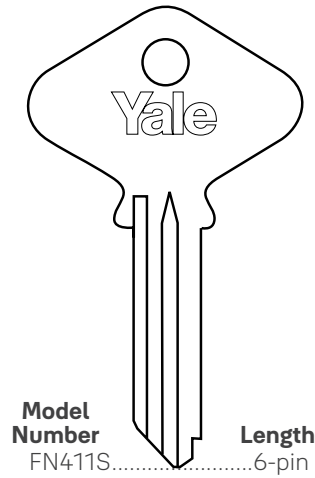

Furnished all 'O' cuts except for #1 cut on tip of key. Stamped with 'Control'. "F" bow shown also available "R" bow.

## SFIC Key Blanks

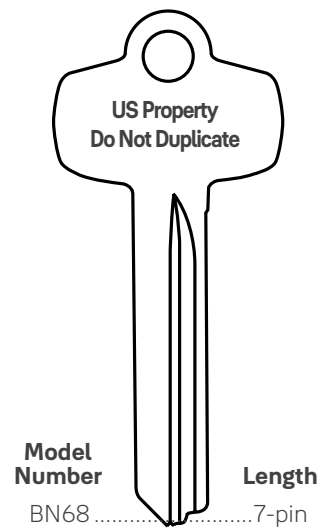
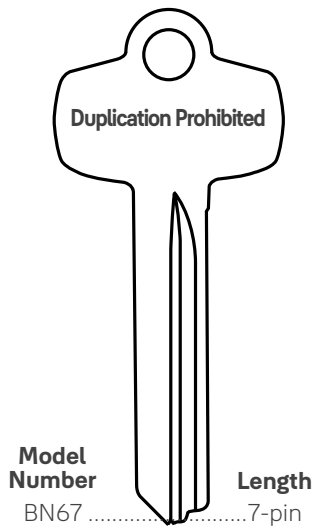

**Note:** SFIC keys are cut from tip to bow. The same key blank can be used for both 6- and 7-pin keys. Only available with Best® keyways A, B, C, D, E, F, G, H, J, K, L and M

# Keyways

## Simplex/Multiplex Keyways

A simplex keyway is independent, stands alone and cannot be tied into any other keyway to expand a keying system. Multiplex keyways can be used together to expand a keying system.

## Active Keyways

Keyways which are available for new Yale® keying systems are considered active. In the case of new master key systems, the factory reserves the right to select the keyway from a range of standard keyways, based on usage in a particular geographical area. Common active keyways shown below.

## All/Multi-Section/Single Section Keys

All multi-section keys can be used on more than one cylinder with different sections. For example: a key cut on the GV multi-section key blank will pass cylinder in the GA, GB, GG and GH keyways. Single section keys can only be used with cylinders of the same section. For example: a key cut on the GA single section key blank will only pass a cylinder in the GA keyway.

## Inactive Keyways

Many older Yale keyways are inactive. New key systems will not be established on these. However, they continue to be available to support existing keying systems.

## Simplex

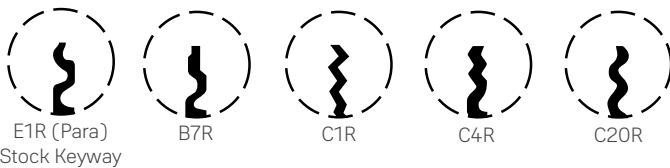

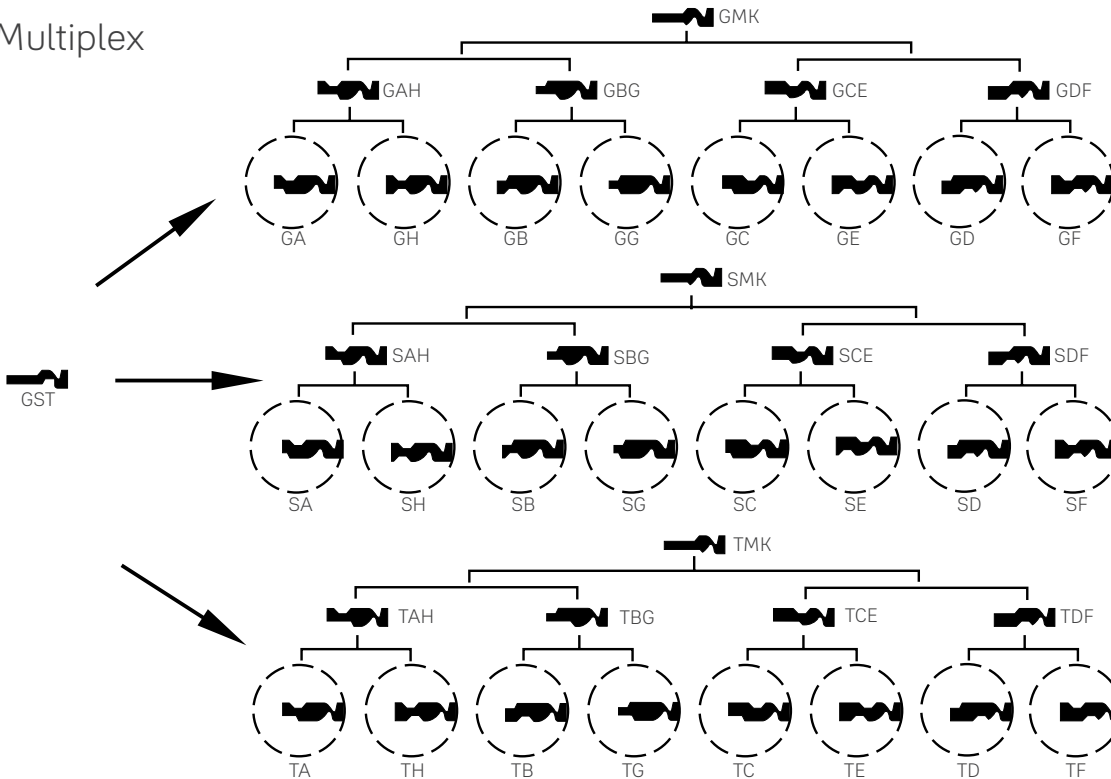

## Multiplex



**Notes:** The section of the key is determined by viewing the key from the bow towards the tip. For security reasons, restricted and protected keyway profiles are not shown.

# Cams

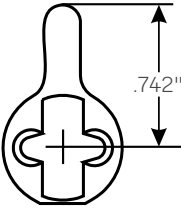
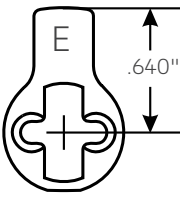
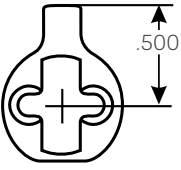
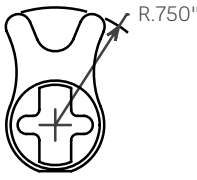
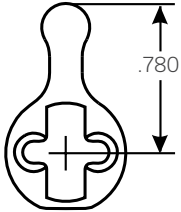
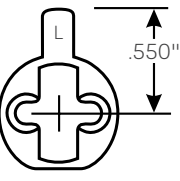
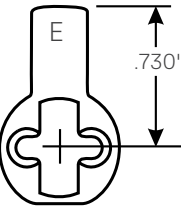
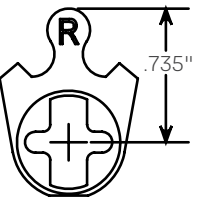
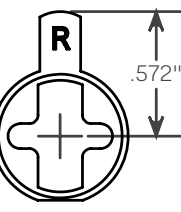
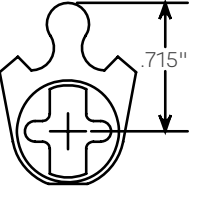
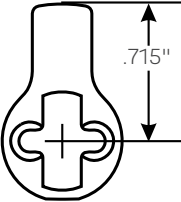

| Model No.   | Description | Application  | Model No.  | Description   | Application  |  |  |
|---|-------------|--|--|---|--------------|--|--|
|    | 2160        | Std for 2123, 2153, S2053, 2719, 5153, U5153, 5719, 2196, 2197, 2196H, 5196, 5197, 5196H | Steel case mortise or auxiliary locks, exit device alarms and cylinder dogging for 7000 series exit devices. |    | 1161E        | Opt for 1194, Std for 2153 when used for 2100 cylinder dogging | Obsolete cast iron mortise locks, cylinder dogging for 2100 series exit devices. |
|    | 2130        | Std for 2123S, 2153S, S2053S, 2196S, 2197S, 5196S, 5197S                                 | Steel case mortise locks, inside operation for 8817-2 and 8834-2 functions.                                  |    | 1161G        | Opt for 1194, 1194H, 5194, 5194H                               | Keyswitches.   |
|   | 1160        | Std for 1153, S1053H, 1719, 5719, U5719  | Obsolete 310 series deadlocks.   |   | 1161L        | Opt for 1123, 1152, S1052H, 5152, U5152                        | Adams Rite MS 1800 series locks and 4700 series latches.                         |
|  | 1160E       | Std for 1194, 1194H, 5194, 5194H   | Obsolete cast iron mortise locks.  |  | 1161U        | Opt for 1194, 1194H, 5194, 5194H                               | Corbin Russwin interchangeable core (A01)  |
|  | 1160L       | Opt for 1194, 1194H, 5194, 5194H   | Adams Rite MS 1800 series locks and 4700 series latches.   |  | 1161T        | Opt for 1123, 1152, 1186, S1052H, 5152, U5152                  | Corbin Russwin fixed core (A01)  |
|  | 1161        | Std for 1123, 1152, S1052H, 5152, U5152  | Obsolete cast iron mortise locks.  |  | 10-6120-9010 | Cam Disc   | Filler for hollow mill cams.   |

All cams and cam disc illustrated actual size.



# Collars

Cylinder collars are supplied as standard where required with products supplied with cylinders. Collar size and thickness are supplied to suit the length of the cylinder, the thickness of the door and the trim ordered. (If door thickness is not specified, collars will be supplied to suit 1-3/4" (44mm) door.)

Collar length required must be specified for cylinders and/or housings ordered separately. Refer to individual product sections for collar applications and sizes.

## 1765 Recessed Cylinder Collar

**"A" Dimension:** See chart for available sizes. To order, specify "1765.size" i.e. 1765.250.

**Material:** Brass, Stainless Steel

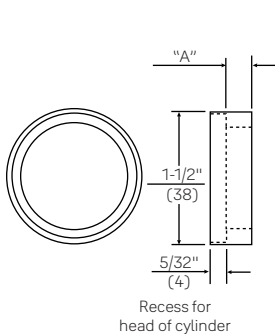

| "A" Dimension |         |
|---------------|---------|
| Size          | Specify |
| 1/16"         | .062    |
| 3/32"         | .094    |
| 1/8"          | .125    |
| 5/32"         | .156    |
| 3/16"         | .187    |
| 7/32"         | .219    |
| 1/4"          | .250    |
| 9/32"         | .281    |
| 5/16"         | .312    |

| "A" Dimension |         |
|---------------|---------|
| Size          | Specify |
| 11/32"        | .344    |
| 3/8"          | .375    |
| 13/32"        | .406    |
| 7/16"         | .437    |
| 15/32"        | .469    |
| 1/2"          | .500    |
| 17/32"        | .531    |
| 9/16"         | .563    |
| 19/32"        | .594    |

| "A" Dimension |         |
|---------------|---------|
| Size          | Specify |
| 21/32"        | .656    |
| 23/32"        | .719    |
| 3/4"          | .750    |
| 27/32"        | .844    |
| 59/64"        | .924    |
| 15/16"        | .937    |
| 1-15/32"      | 1.473   |

## 1766 Step Collar for U5109 and U5153 High Security Cylinders.

**Material:** Stainless Steel

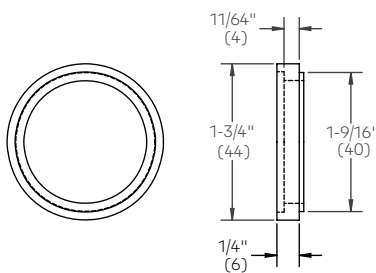

## KP4 Flush Mount Cylinder Collar

**Material:** Brass, Bronze

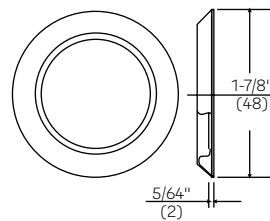

## 599 Recessed Cylinder Collar

**"A" Dimension:** See chart for available sizes. To order, specify "599.size" i.e. 599.419.

**Material:** Brass

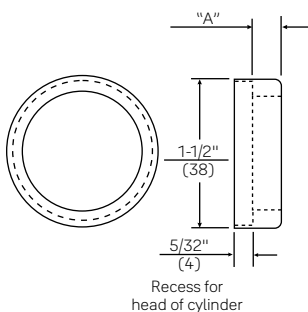

| "A" Dimension |         |
|---------------|---------|
| Size          | Specify |
| 27/64"        | .419    |
| 35/64"        | .544    |
| 45/64"        | .700    |
| 55/64"        | .850    |
| 59/64"        | .925    |
| 1-3/64"       | 1.040   |



## Pins And Pin Kits

Yale® pinning kits contain the components required to key Yale conventional cylinders, both fixed and large format interchangeable core. (.51" plug diameter).

All components are packed in a sturdy metal case.

## Features

- Pin tray lifts out to provide storage space.
- Pin chart on inside lid for convenient reference.

Pins and springs are packed by size, in bags of 100. Each kit contains bottom pins, master pins, top pins and springs. Both kits include tweezers and a plug follower.

| SK-12 Pin Kit - .019" Step |      |                       |           |            |
|----------------------------|------|-----------------------|-----------|------------|
| Model No.                  | Qty. | Description           | Size      | Pin Length |
| SK-12                      | 1    | Pin Kit - Complete    | .019 Step | ---        |
| R19                        | 1    | Refill Kit - Complete | .019 Step | ---        |
| 020                        | 1    | Plug Follower         | ---       | ---        |
| 021                        | 1    | Tweezers              | ---       | ---        |
| 251-0                      | 100  | Bottom Pin            | 0         | .182       |
| 251-1                      | 100  | Bottom Pin            | 1         | .201       |
| 251-2                      | 100  | Bottom Pin            | 2         | .220       |
| 251-3                      | 100  | Bottom Pin            | 3         | .239       |
| 251-4                      | 100  | Bottom Pin            | 4         | .258       |
| 251-5                      | 100  | Bottom Pin            | 5         | .277       |
| 251-6                      | 100  | Bottom Pin            | 6         | .296       |
| 251-7                      | 100  | Bottom Pin            | 7         | .315       |
| 251-8                      | 100  | Bottom Pin            | 8         | .334       |
| 251-9                      | 100  | Bottom Pin            | 9         | .353       |
| 351-2                      | 100  | Top Pin (Driver)      | 2         | .152       |
| 351-3                      | 100  | Top Pin (Driver)      | 3         | .190       |
| 351-4                      | 100  | Top Pin (Driver)      | 4         | .230       |
| 451-2                      | 100  | Master Pin            | 2         | .038       |
| 451-4                      | 100  | Master Pin            | 4         | .076       |
| 451-6                      | 100  | Master Pin            | 6         | .114       |
| 451-8                      | 100  | Master Pin            | 8         | .152       |
| 151                        | 100  | Spring                | ---       | ---        |

| SK-13 Pin Kit - .025" Step |      |                       |           |            |
|----------------------------|------|-----------------------|-----------|------------|
| Model No.                  | Qty. | Description           | Size      | Pin Length |
| SK-13                      | 1    | Pin Kit - Complete    | .025 Step | ---        |
| R25                        | 1    | Refill Kit - Complete | .025 Step | ---        |
| 020                        | 1    | Plug Follower         | ---       | ---        |
| 021                        | 1    | Tweezers              | ---       | ---        |
| 251A-0                     | 100  | Bottom Pin            | 0         | .182       |
| 251A-1                     | 100  | Bottom Pin            | 1         | .207       |
| 251A-2                     | 100  | Bottom Pin            | 2         | .232       |
| 251A-3                     | 100  | Bottom Pin            | 3         | .258       |
| 251A-4                     | 100  | Bottom Pin            | 4         | .282       |
| 251A-5                     | 100  | Bottom Pin            | 5         | .307       |
| 251A-6                     | 100  | Bottom Pin            | 6         | .334       |
| 251A-7                     | 100  | Bottom Pin            | 7         | .357       |
| 351-2                      | 100  | Top Pin (Driver)      | 2         | .152       |
| 351-3                      | 100  | Top Pin (Driver)      | 3         | .190       |
| 351-4                      | 100  | Top Pin (Driver)      | 4         | .230       |
| 451A-2                     | 100  | Master Pin            | 2         | .050       |
| 451A-3                     | 100  | Master Pin            | 3         | .076       |
| 451A-4                     | 100  | Master Pin            | 4         | .100       |
| 451A-5                     | 100  | Master Pin            | 5         | .125       |
| 451A-6                     | 100  | Master Pin            | 6         | .152       |
| 451A-7                     | 100  | Master Pin            | 7         | .175       |
| 151                        | 100  | Spring                | ---       | ---        |



# Pinning Tools

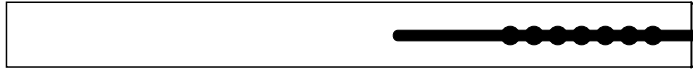

**Set up plug**  
**No. M36 For .51" plug**  
**No. M38 For .40" plug**

**No. M43 Shove Knife**

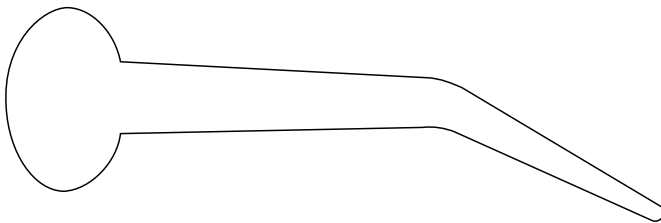

**No. 020 Plug Follower**  
**For .51" plug**

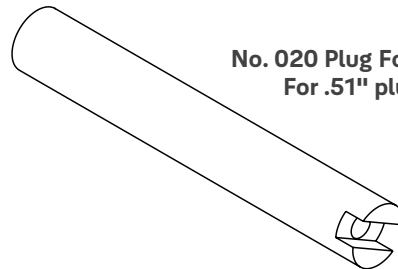

**No. 021 Tweezers**

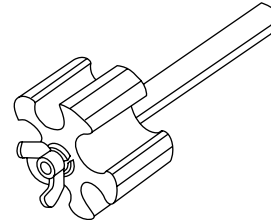
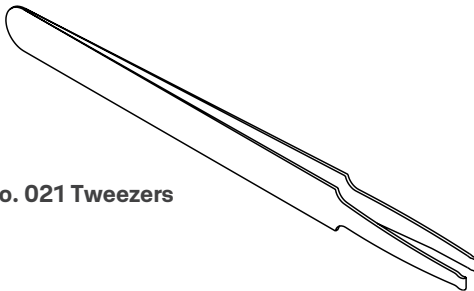

**No. M33 Vice Held Plug Holder**

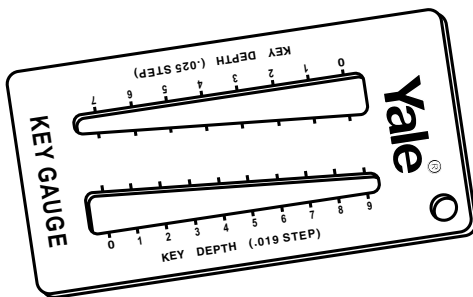

**No. KG1 Key Gauge (.019" and .025" increment)**

Holds the 5 most popular plug diameters:

- .404" (10.26mm)
- .504" (12.80mm)
- .508" (12.90mm)
- .512" (13.00mm)
- .556" (14.12mm)

# Parts



## Mortise

| Plugs        |                          |
|--------------|--------------------------|
| Part Number  | Description              |
| 96-0000-2004 | Fixed Core 6-pin, 1-1/8" |
| 96-0000-2005 | Fixed Core 6-pin, 1-1/4" |
| 96-0000-2006 | Fixed Core 7-pin, 1-1/4" |
| 96-0000-2009 | Fixed Core 7-pin, 1-1/2" |
| 96-0000-2013 | Fixed Core 6-pin, 1-3/4" |
| 96-0000-2014 | Fixed Core 7-pin, 1-3/4" |
| 96-0000-2705 | LFIC 6-pin               |
| 96-0000-2706 | LFIC 7-pin               |

Specify Keyway and Finish

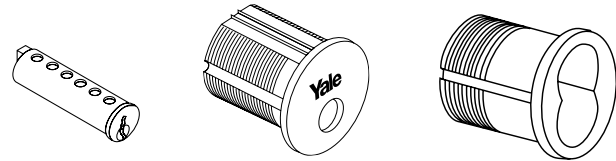

| Shells       |                                |
|--------------|--------------------------------|
| Part Number  | Description                    |
| 10-1152-2031 | Fixed Core 6-pin, 1-1/8"       |
| 10-1152-2064 | Fixed Core 6- or 7-pin, 1-1/4" |
| 10-1152-2023 | Fixed Core 7-pin, 1-1/2"       |
| 10-1152-2033 | Fixed Core 6- or 7-pin, 1-3/4" |

Specify Finish

| Housings (Less Cam) |                      |
|---------------------|----------------------|
| Part Number         | Description          |
| 10-1194-2033        | LFIC 6-pin, 1-1/2"   |
| 10-1194-2035        | LFIC 6-pin, 1-3/4"   |
| 10-1194-0004        | LFIC 7-pin, 1-11/16" |
| 10-1194-2036        | LFIC 6- or 7-pin, 2" |

Specify Finish

| Other            |                                      |
|------------------|--------------------------------------|
| Part Number      | Description                          |
| 10-1194-2041-000 | Cam hub for 6-pin, 1-1/2" housing    |
| 10-1194-2043-000 | Cam hub for 6-pin, 1-3/4" housing    |
| 10-1194-2041-000 | Cam hub for 7-pin, 1-11/16" housing  |
| 10-1194-2044-000 | Cam hub for 6- or 7-pin, 2" housing  |
| 99-9999-4525-999 | Plug retainer for 1210 and 1220 core |
| 81-0611-0154-036 | Cam screws for 2153, 2196 and 2197   |

## Component

| Plugs        |                                   |
|--------------|-----------------------------------|
| Part Number  | Description                       |
| 96-0000-2154 | Fixed Core 6-pin for 1801 or 1802 |
| 96-0000-2156 | Fixed Core 7-pin for 1801 or 1802 |
| 96-0000-2234 | Fixed Core 6-pin for 1803         |

Specify Keyway and Finish

| Shells           |                                   |
|------------------|-----------------------------------|
| Part Number      | Description                       |
| 14-1801-2021-000 | Fixed Core 6-pin for 1801 or 1802 |
| 14-1802-2050-000 | Fixed Core 7-pin for 1801 or 1802 |
| 14-1803-2001-000 | Fixed Core 6-pin for 1803         |

| Other            |                                |
|------------------|--------------------------------|
| Part Number      | Description                    |
| 99-9999-4561-999 | Plug retainer for 1801 or 1802 |
| 99-9999-4001-000 | Roll pin for 1802              |
| 14-5407-1039-048 | Tailpiece for 1802             |
| 17-1803-7001     | Cap pin spring for 1803        |
| 17-1803-2002     | Cap pin for 1803               |
| 17-1803-2003     | Cylinder cap for 1803          |
| 17-1194-2302     | Spring cover 6-pin for 1803    |

See pages 14-17 for additional tailpiece part numbers.



# Parts

## Rim

| Plugs        |                                 |
|--------------|---------------------------------|
| Part Number  | Description                     |
| 96-0000-2225 | Fixed Core 5-pin for 1109       |
| 96-0000-2226 | Fixed Core 6-pin for 1109       |
| 96-0000-2227 | Fixed Core 7-pin for 1109       |
| 96-0000-2705 | LFIC 6-pin                      |
| 96-0000-2706 | LFIC 7-pin                      |
| 96-0000-2330 | Fixed Core 5- or 6-pin for 1709 |
| 96-0000-2331 | Fixed Core 7-pin for 1709       |

Specify Keyway and Finish

| Housings     |             |
|--------------|-------------|
| Part Number  | Description |
| 10-1193-0041 | LFIC 6-pin  |
| 10-1193-0042 | LFIC 7-pin  |

Specify Finish

| Shells       |                                 |
|--------------|---------------------------------|
| Part Number  | Description                     |
| 34-1109-2027 | Fixed Core 5-pin for 1109       |
| 34-1109-2028 | Fixed Core 6-pin for 1109       |
| 34-1109-2029 | Fixed Core 7-pin for 1109       |
| 10-1709-2096 | Fixed Core 5- or 6-pin for 1709 |
| 10-1709-2099 | Fixed Core 7-pin for 1709       |

Specify Finish

| Other            |                          |
|------------------|--------------------------|
| Part Number      | Description              |
| 34-1145-1002-059 | 1145 Tailpiece           |
| 34-1147-1003-059 | 1147 Tailpiece           |
| 34-1145-1005-059 | Von Duprin Tailpiece     |
| 34-0010-1015-059 | Backplate                |
| 34-2311-8738-048 | Mounting screws for 1109 |
| 10-1193-1018-049 | Mounting screws for 1193 |
| 34-1451-1003-000 | Plug retainer for 1109   |
| 99-9999-4561-999 | Plug retainer for 1709   |
| 14-3511-6102-082 | Lazy cam for 1709        |
| 14-3511-1014-048 | D-Ring for 1709          |
| 10-1451-1010-048 | Tailpiece for 1709       |
| 14-3511-1013-048 | Lazy cam collar for 1709 |

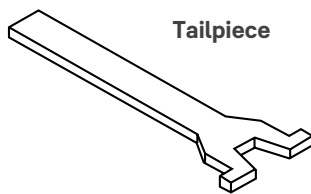

Tailpiece

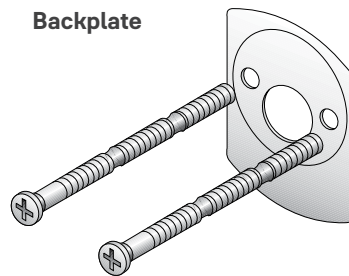

Backplate



Retainer

## Dust Shields

Cylinders are available with a dust shield to protect the pin tumblers and plug from the penetration of dust, sand and other contaminants. To order, prefix the cylinder model number with the letter "D", i.e. D2153. Dust shields are not available with any cylinder using "A" bow keys.

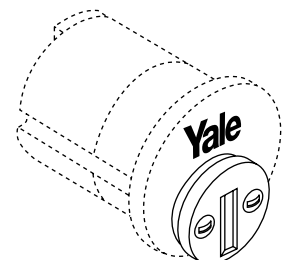

# .019" Specification

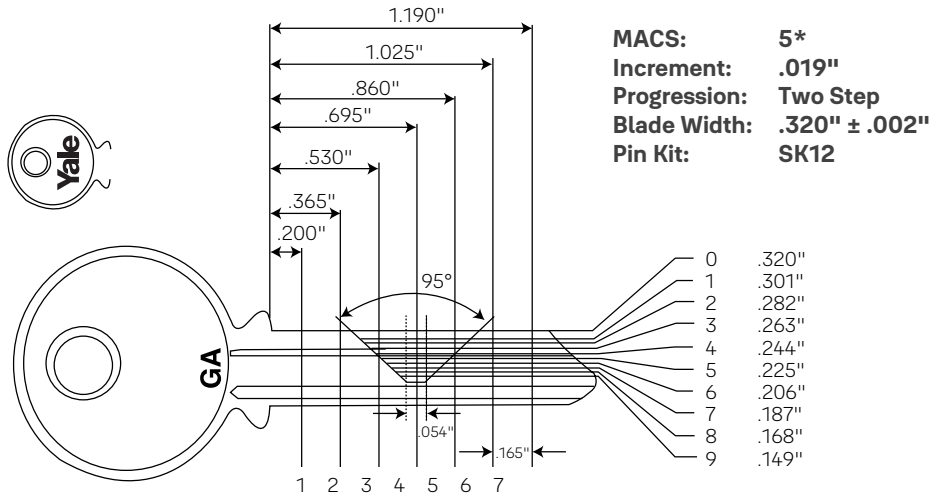

**MACS:** 5\*  
**Increment:** .019"  
**Progression:** Two Step  
**Blade Width:** .320" ± .002"  
**Pin Kit:** SK12

Cuts are read and written BOW to TIP.

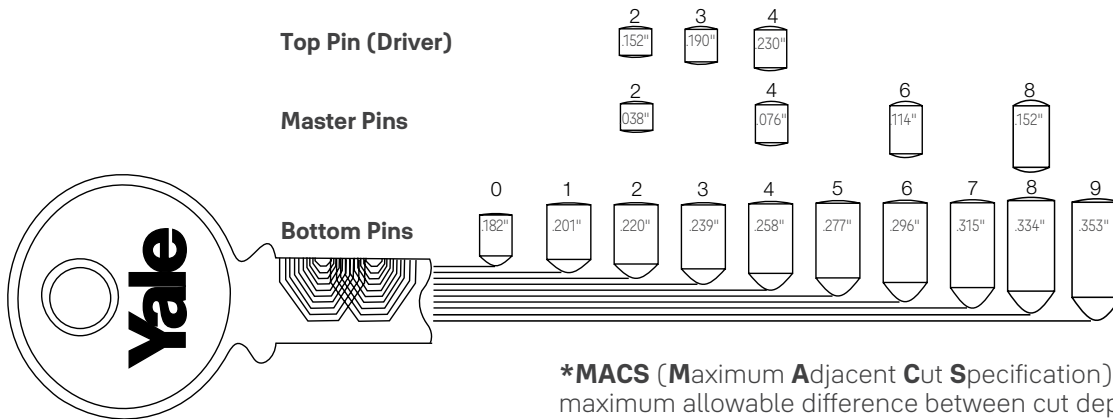

**\*MACS (Maximum Adjacent Cut Specification):** the maximum allowable difference between cut depths.  
**Note:** Illustrations are not drawn to actual size.

## Pinning Formula

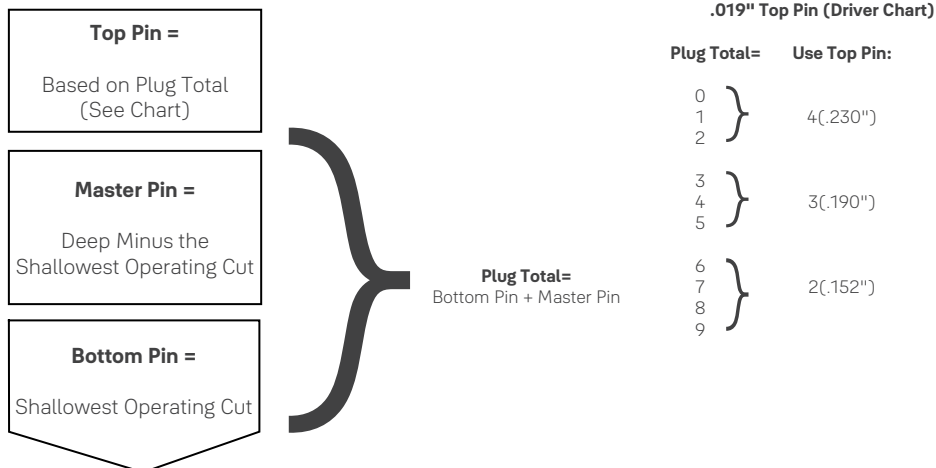

# .019" Specifications For Bump Resistant Cylinders

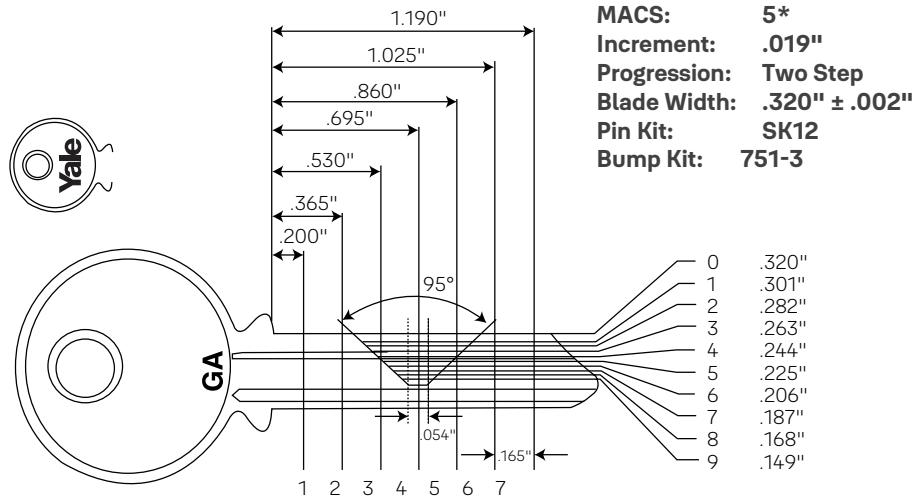

**MACS:** 5\*  
**Increment:** .019"  
**Progression:** Two Step  
**Blade Width:** .320" ± .002"  
**Pin Kit:** SK12  
**Bump Kit:** 751-3

Cuts are read and written BOW to TIP.

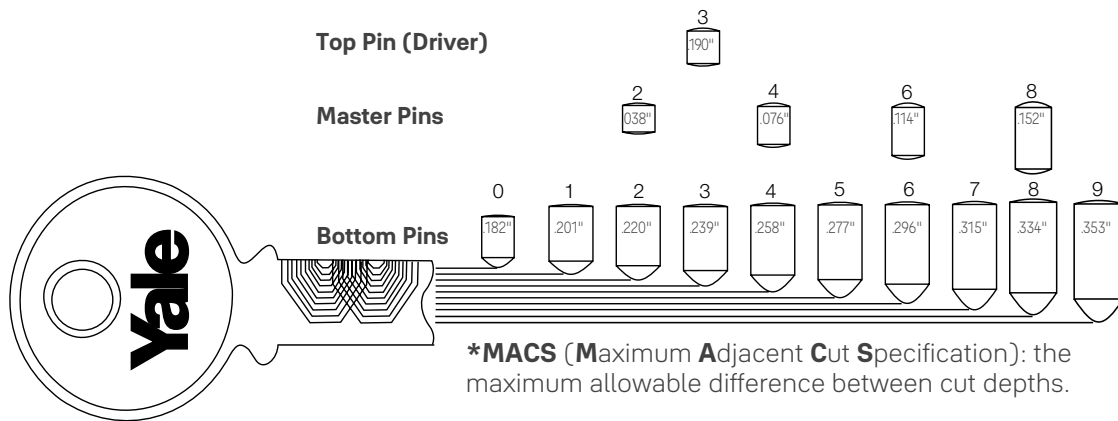

\***MACS (Maximum Adjacent Cut Specification):** the maximum allowable difference between cut depths.

**Note:** Bump resistance is only achieved when all chambers include a bump resistant pin. Illustrations are not drawn to actual size or configuration.

## Pinning Formula

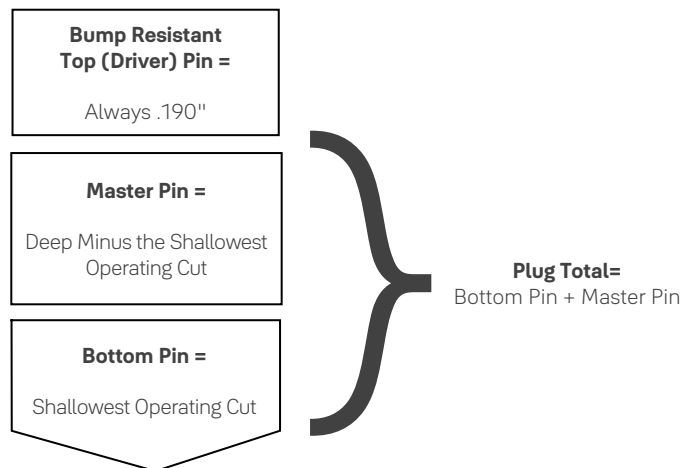



## Procedures

Yale® keying systems utilize the Standard Key Coding System illustrated on the following pages. To ensure prompt and accurate processing, purchase orders should be written using these key symbols to describe each master keyed item. In addition to the key symbol, Yale requires the following information on the keying system for ALL orders:

- End User (job) Name
- City, State, Zip Code
- Special key bows or key stamping
- VKC/CKC requirements (see page 4)

## Existing System Add-Ons

For prompt processing, orders must include a positive identification for the keying system in addition to the job name, city, state and ZIP code. Any ONE of the following is positive ID:

- Registry number stamped on any existing factory master key
- Previous factory order number together with the year of that order

## Letters Of Authorization

No letter is needed when the items are to be drop shipped directly to the end user. In all other cases, to preserve the security of the end user's keying system, Yale requires a letter of authorization on the end user's letterhead to obtain the following:

- Bitting lists
- Security blanks and cut keys
- Master level cut keys
- Patented key blanks, cylinders and plugs

The letter of authorization can be brief but should include a specific description of what is being authorized for release, and a positive key system identification.

**XYZ Corporation** **1 Main St.**  
**Anytown, USA 00001**  
**(203) 555-5555**

---

(Current Date)

Yale  
Key Systems Dept.

We authorize Acme Distributors to obtain a copy of the bitting list for our keying system R75235. We also authorize them to order the quantities of master keys on our attached purchase order 1234AB.

Sincerely,

Gordon Morris  
Security Director

## New Systems Or New Branches Of Existing Systems

Indicate system expansion in terms of estimated numbers of key combinations, not doors. All of this information is essential at the inception of a keying system in order for Yale to ensure that the end user's present and future security requirements are met. Advise as follows:

- How many levels of keying?
- Plan for a construction master key?
- Any selective master keys, such as ENG?
- How many changes for each master?
- How many masters for each grand master? If mixing Yale cylinder types, indicate clearly where each type of cylinder will be used within the expansion parameters:
  - Which masters or grands have security cylinders under them?
  - Which have interchangeable cores?
  - Which have conventional cylinders?

### ASSA ABLOY FLASHship™ Masterkey Program

The **ASSA ABLOY FLASHship™** program is proud to offer the most comprehensive masterkeying program in the industry. Enjoy the convenience of masterkeying up to 250 Yale cylinders and 200 change keys with 24 hour processing! This simple Level 2 masterkey system is available for Yale cylinders, locks, and exit trim in the PARA keyway.

You can now also expand existing FLASHship Masterkey systems with the easy FLASHship online order entry process. Simply provide either the job name, original FLASHship order number, or the system registry number to order. Please ask your Door Security Solutions sales consultant for a demonstration of the order process.



# Designing Master Key Systems

## Step 1

### Determine the type of locking system

- Conventional "open & restricted keyways"
  - Not contract controlled
- Patented locking system
  - A notice of acceptance will be required between Yale and Owner
  - Factory-based system
  - Key blank distribution restrictions are in place
- Security (secondary locking mechanisms)
- High security (same as Security plus UL437)
- Stand-alone access control locking devices (at door wiring)
  - To facilitate multiple users through common doors
- Integrated locking systems (hard wired into access control systems)

## Step 2

### Establish the level of the master key system. The higher the level the less secure.

- Level two – "Simple Master Key system"
  - Change key, and master key only
- Level three – "Grand Master Key system"
  - Change key, master key, and grand master key
- Level four – "Great Grand Master Key system"
  - Change key, master key, grand master key
- Levels higher than four are not recommended for security reasons
  - With more levels, additional master pins in each chamber of the cylinder would be required, and with the additional master pins the possibility of unauthorized key interchanges could occur

See pages 32-34 on How to Establish Key Systems.

## Step 3

### Establish key hierarchy, key issuing policies and procedures, and administrative disciplines.

- Who, if anyone, is authorized to carry the top master key?
- Who carries master keys and change keys?
  - Does every employee receive a key?
- What disciplinary action(s) is being put in place for violations?
  - Fines or Deposits
    - Lost keys
    - Keys not returned
  - Will there be a key receipt required?
    - Where will that be kept?
- Who is the systems administrator?
  - Authorized to purchase
  - Responsible for Key Control Administration
- Who is the Key Control Administrator?
  - Maintain key control software & all transactions

## Step 4

### System Layout

- Helpful Hints
  - KISS "Keep It Simple System"
    - Do not use the term sub-master (not unless it's level 6 and higher)
- Lowest level possible
- Key to the building security objectives NOT to the people
  - Determine if the system is to be designed for Security or Convenience
- No cross keying, especially with patented locking systems and higher
- Key alike within master key groups as much as possible
  - Avoid top-heavy systems (example; few change keys used under masters)

- Has the right function of lockset been selected?
  - Storeroom vs. Classroom vs. Entry
  - Single cylinder vs. double cylinder
    - If double cylinder, how is the inside cylinder to be keyed?
- Provide adequate quantity of keys
  - Top master keys "limit the number of these to only a few"
  - Master keys "also limit the number these"
  - Change keys per key set and/or per keyed alike sets
  - Special operating keys
    - Control keys "limit the number of these"

### Separate the internal departments into sectors, example are:

- Perimeter
  - Including all exterior doors, roof surfaces, gates and fences, and adjacent buildings.
- Operations
  - Sensitive areas crucial to daily operations, such as plant engineering, security and mechanical operations.
- Management
  - Areas that are vital for daily business activities, primarily human resources, administration, executive offices, IT, sales, and accounting.
- Services
  - Areas that provide employees and visitors with services, such as restrooms, medical treatment areas, housekeeping, food service, retail (unless it's a leased outside source).
- Unique Applications
  - Door openings requiring access control hardware where key override is required, or any other special application which would be unique.
- Tenants
  - Any tenants that are not part of the building.

## Step 5

### Servicing & Maintenance

- In-house or outside locksmith
  - Ensure proper training
  - Establish key cutting log
  - Establish service request procedures
- Service equipment
  - Key kit
  - Code cutter that complies with systems depths & spacing specifications
  - Locksmithing tools, fixtures & accessories
- Establish stock levels & requirements to avoid misuse of multi-section key blanks
  - Additional cylinders ready for emergencies
  - Additional key blanks (of all keyways)
- Who or where are the key blanks going to be kept?
- Who is authorized to cut keys?
  - What form of work order will be used to authorize cutting of keys?
  - Who will sign the work order?
  - What records will be kept & where?
- What type of reports will be required?
  - Overdue keys
  - Miss-cut keys
    - Who receives the reports?
- Once a key has been cut, what instructions are given to the recipient?
  - Key receipt recommended
- Ensure that all transactions are recorded by the Key Control Administrator
- ENFORCEMENT FROM THE START! SUPPORT AND BACK THOSE WHO ARE RESPONSIBLE FOR MAINTAINING AND SERVICING THE SYSTEM.



# How To Establish Master Key Systems

## Simple Master Key System (2 Levels of Keying)

The master key symbol consists of TWO letters, such as **AA**. The change key numbers are added to the master key letters. The numbers come FIRST: **1AA, 2AA, 3AA**, etc.

When locks are required which are not operated by the master key or other change keys in the system, they are referred to as "single keyed" and given symbols **SKD1, SKD2**, etc. When all higher levels of master keys are to be disallowed, suffix (**NMK**) to the symbol of the key which is to operate. This means "not master keyed." Cylinder **1AA(NMK)** is operated by **1AA** only. The **AA** master is blocked from operation.

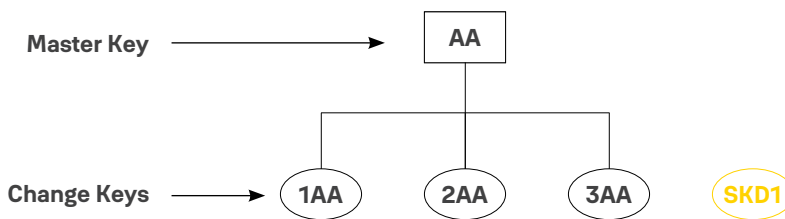

## Grand Master Key System (3 Levels of Keying)

The grand master is assigned any ONE letter, such as **A**. The master keys under this grand are assigned TWO letters, the first of which must be the same as the grand: **AA, AB, AC**, etc. are all masters under grand **A**. Caution: Do not use the letters **I, O** or **Q** because of possible confusion with the numerals 1 and 0, respectively. Also do not use the letter **X** due to confusion with cross keying. Change key numbers come after the letters.

If the cylinder is to be operated by its change key and nothing lower than the single lettered GMK, the change number is added to the GMK symbol. This is illustrated by the example **A1** in the schematic shown.

When locks are required which are not operated by ANY master keys or other change keys in the system, they are referred to as "single keyed" and given symbols **SKD1, SKD2**, etc.

When all higher levels of master keys are to be disallowed, suffix (**NMK**) to the symbol of the key which is to operate. This means "not master keyed" and can be applied to any level in the system. Cylinder **AA1 (NMK)** is operated by **AA1** only. The **AA** master and **A** grand are blocked from operation. Cylinder **AA (NMK)** would be operated by the **AA** master only. Grand **A** does not operate.

For master keys beyond **AZ**, insert a numeral between the letters to designate which pass through the alphabet they represent. **A2A** through **A2Z** represents the second pass of masters under grand **A**. **A3A** through **A3Z** would be the third. Change keys under these masters have the numbers suffixed in the usual way: **A2A1, A2A50**, etc.

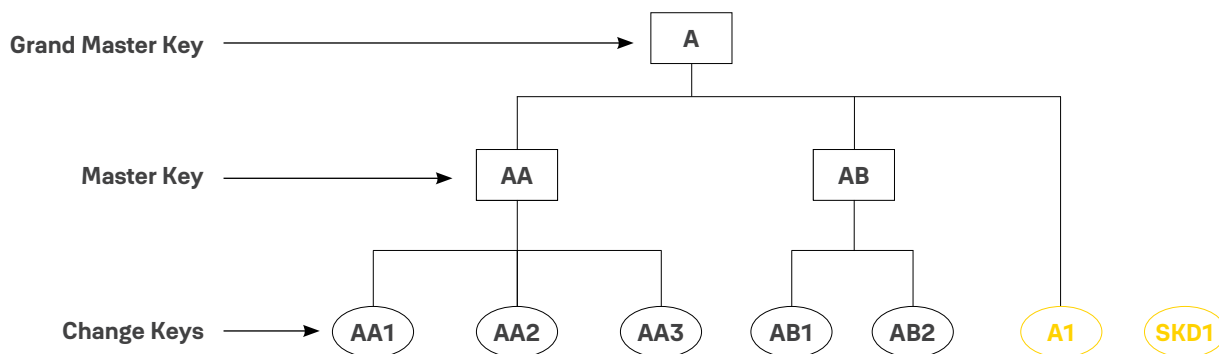





# How To Establish Master Key Systems

## Great Grand Master Key System (4 Levels of Keying)

The great grand master key is assigned the symbol **GGM**. The rest of the symbols are the same as those in 3-level systems: The GMKs are assigned single letters, e.g., **A, B, C, D**, etc. Caution: Never use **X** for a grand master key due to the confusion which will result with cross keying symbols presented on page 34.

Masters under each GMK are assigned two letters, the first of which is the same as its respective grand master key. Change key numbers come after the letters. Changes under the grand (**A1, B1**, etc.) and masters beyond **AZ** are handled exactly as in the 3-level system already described.

Changes directly under a grand are also handled as illustrated in the 3-level system. For changes directly under the **GGM** with no intermediate level masters, the change number is added directly to **GGM** as shown by the example **GGM1** in the schematic.

When locks are required which are not operated by ANY master keys or other change keys in the system, they are referred to as "single keyed" and given symbols **SKD1, SKD2**, etc.

When all higher levels of master keys are to be disallowed, suffix (**NMK**) to the symbol of the key which is to operate. This means "not master keyed" and can be applied to any level in the system. Cylinder **AA1 (NMK)** is operated by **AA1** only. The **AA** master, **A** grand and **GGM** are all blocked from operation. Cylinder **AA (NMK)** is operated by the **AA** master only. Grand **A** and the **GGM** do not operate. Cylinder **A (NMK)** would be operated by the **A** grand only, without the **GGM**.

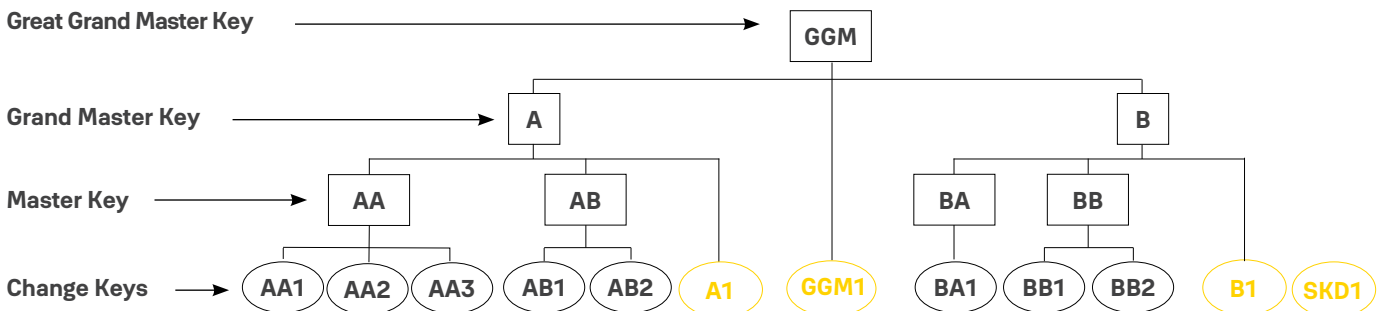

## Selective Master Keys

It is often useful in large keying systems to issue a high level master key to maintenance personnel which allows access across all master and grand master key boundaries of a keying system. A selective master key is usually very close to the system's top master key, both physically and through its realm of access. Nevertheless, it must be blocked from operating in many areas.

a system in which key **AA1** is to operate two different offices. Inside one of them is an electrical cabinet which must be accessible to maintenance personnel carrying the **ENG** key. That lock must be specified as **AA1 (ENG)** while the lock for the other office must be specified as **AA1**. Change keys directly under the selective key, such as **ENG1**, are operated by all higher level keys, such as **GGM**.

The most common names and symbols for selective master keys are:

- ENG** Engineer's key
- ATT** Attendant's key
- JAN** Janitor's key
- HKP** Housekeeper's key
- GRD** Guard's key
- MAIN** Maintenance

Like cross keying, a selective master key is a convenience feature which decreases the security of the cylinders it operates and limits the expansion and flexibility of the overall keying system.

To designate that a lock be operated by a selective master key, suffix the symbol in parentheses to the standard symbol. Example: **AA1 (ENG)**. This must be added every time the selective key is to operate and left off whenever the selective key is NOT to operate. For instance, you may lay out

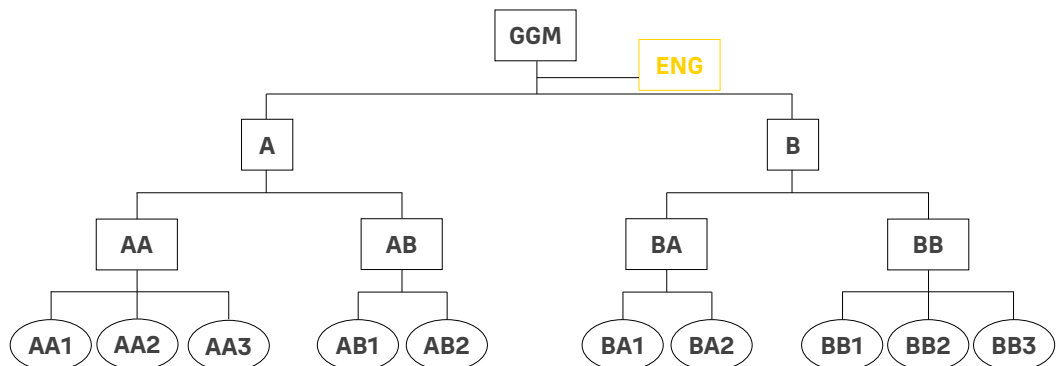

# How To Establish Master Key Systems



## Convenience May Reduce Cylinder Security and Hinder System Expansion

Whenever two or more different keys such as **AA1** and **AA2** are both required to operate the same cylinder, the cylinder's security is reduced. This is called cross keying. When the cross keying occurs under all the same higher level keys, such as **AA1** and **AA2**, it is known as controlled cross keying. When it combines keys under different higher level keys, such as **AA1** and **AB1**, it is known as uncontrolled cross keying.

In addition to reducing the security of the cylinder, cross keying usually imposes limits on the flexibility and expansion of the overall keying system. This is especially true of uncontrolled cross keying. For these reasons, it is strongly recommended to allow personnel to carry more than one key. Cross keying should be discouraged whenever possible. However, when cross keying is required, it is specified as follows, and should be summarized at the beginning of each order.

## Case #1

Cylinder requires its own change key. The illustration depicts part of a small medical building where two doctors share a common receptionist. The receptionist gets the **AA3** key. Each doctor carries a key which operates only one office, but is also cross keyed into the entrance from the corridor.

Determine the symbol of the change key (example: **AA3**). Then prefix the letter X (example: **XAA3**). Then list all keys which are to operate in an "operated by . . ." phrase. Example: "**XAA3** operated by **AA1**, **AA2**, **AA** and **A**". Note that **X** is a cylinder specification only. The keys for cylinder **XAA3** are designated **AA3**.

## Case #2

Cylinder does NOT require its own change key. This illustration depicts a section of a floor in a dormitory. Each student's bedroom key operates the hall door lock. There is no need to construct a key which operates only the hall door.

In this case, place an **X** at both the beginning and end of the symbol and a number between them. Example: **X1X**, **X2X**, etc. Again, always include the "operated by . . ." phrase with a complete listing of key symbols to operate.

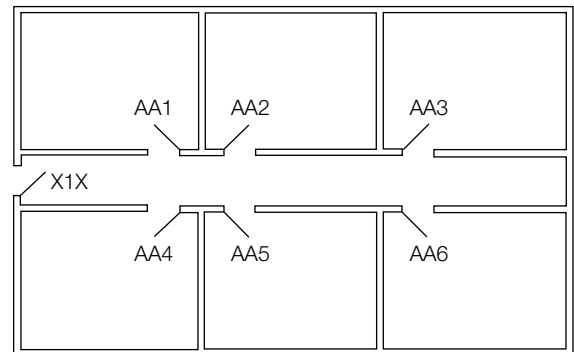

X1X operated by AA1 through AA6, AA and A.





**Trusted every day**

**Phone**

1-855-557-5078

**Customer Service Email**

customerservice.yale@assaabloy.com

**Technical Product Support Email**

techsupport.yale@assaabloy.com

**Order Entry Email**

orders.yaleus@assaabloy.com

**Fax**

1-800-338-0965

**Website**

www.yalecommercial.com

## Contact Us

### U.S.A.

**Yale Locks & Hardware**

Address: 225 Episcopal Road

Berlin, CT 06037-4004

Tel: 1-800-438-1951

Fax: 1-800-338-0965

yalecommercial.com

### Canada:

**ASSA ABLOY Door Security Solutions Canada**

Address: 160 Four Valley Drive

Vaughan, Ontario L4K 4T9

Tel: 1-800-461-3007

Fax: 1-800-461-8989

assaabloydss.ca

### International:

**ASSA ABLOY Americas International**

Tel: 1-905-821-7775

Fax: 1-905-821-1429

assaabloyai.com

**THE YALE BRAND**, with its unparalleled global reach and range of products, reassures more people in more countries than any other consumer locking solution.

**THE ASSA ABLOY GROUP** is the world's leading manufacturer and supplier of locking solutions, dedicated to satisfying end-user needs for security, safety and convenience.

Yale Commercial is a business associated with ASSA ABLOY Access and Egress Hardware Group, Inc., an ASSA ABLOY Group company. Copyright © 1998-2022, ASSA ABLOY Access and Egress Hardware Group, Inc. All rights reserved. Reproduction in whole or in part without the express written permission of ASSA ABLOY Access and Egress Hardware Group, Inc. is prohibited. Patent pending and/or patent [www.assaabloydss.com/patents](http://www.assaabloydss.com/patents).