



SCHLAGE

Key systems

Product and application reference guide



Innovation at its core

From the sleek beauty of L Series to the beyond-grade-1 performance of ND locksets, count on Schlage® for mechanical, electrified and electronic lock solutions. And at the center of them all, are key systems as innovative and diverse as the locks they support.

Schlage's layered security approach to key systems let's you combine standard open security with restricted solutions and those that meet your highest security needs under one keyway design. It's innovative thinking that is flexible and upgradeable to fit your security needs well into the future.

Information and customer care



commercial.schlage.com



US 877.671.7011
Canada 800.900.4734



Customer support: support@allegion.com
Mechanical_Locks_TechProdSupport@allegion.com



www.youtube.com/schlagesecurity



<https://restrictedproduct.allegion.com>



Knowledge Center: kc.allegion.com

Ordering



Allegion_Orders@allegion.com



eFax: 1.833.312.3669



Innovation that works for you

Over a century ago Walter Schlage invented the cylindrical lock. His was a simple solution to a problem hidden in plain sight, and from it he built a company that has since grown to become one of the most recognizable names in the security industry. Delivering on quality and building on the trust of our customers, Schlage continues a legacy of providing innovative locking hardware and access control solutions to suit all types of commercial, institutional and multi-family spaces. And everything we do is backed by friendly, knowledgeable service and support.

Beyond the brand

Schlage is part of the Allegion family of safety and security solutions featuring other pioneering brands like LCN® and Von Duprin®. Focusing on security around the door and in adjacent areas, we strive to be a trusted advisor to our customers, providing seamless access solutions to secure buildings, people and property. We do this by collaborating with our customers and offering valued services that support their day to day responsibilities, including architectural and specification consulting, security and safety consulting, technical services, code compliance support, and training.



Use Schlage layered security to your advantage

There are two ways to look at key system security. The first, administrative security, is about key control. It relates to the barriers you put in place to prevent unwanted duplication. The second, physical security, is based on design features that determine the cylinder's resistance to bypass through picking, bumping or drilling.

Utilizing Schlage's layered security approach, you can apply different cylinder types and levels of administrative control on a door by door basis throughout a facility under a single keyway family. You gain budget savings where risks are low, appropriate high-security solutions where needed, and maintenance simplicity.



Interact with the key system chart at <https://us.allegion.com/keysystems>

Administrative Security		Schlage Everest 29™			
		Schlage Classic Obverse	End user exclusive nationwide	4N	9N
Primus® geographically exclusive side bit milling options	End user exclusive within time zone/country	4Z		9Z	
	End user exclusive within zip code	3G		9G	
	End user controlled; non-exclusive	3U	9U		
	Dealer exclusive within time zone/country	2	8		
	Dealer exclusive within zip code	1+	7		
	Authorized dealer only; non-exclusive	1			

Physical Security	
<p>End user controlled; non-exclusive</p> <p>Authorized dealer only</p> <p>No authorization</p> <p>OPEN Schlage Classic Obverse FSIC and Conventional</p> <ul style="list-style-type: none"> Duplicate anywhere 	<p>OPEN Schlage Everest 29 S FSIC and Conventional</p> <ul style="list-style-type: none"> Patented design Check pin in cylinder
<p>RESTRICTED Schlage Everest 29 R¹ SFIC, FSIC² and Conventional³</p> <p>Schlage Everest 29 T FSIC and Conventional</p> <ul style="list-style-type: none"> Requires letter of authorization Patented design Check pin in cylinder 	<p>Primus RP RESTRICTED Schlage Classic Obverse FSIC and Conventional</p> <ul style="list-style-type: none"> 5 levels of side bit milling exclusivity Patent protection to 2029 Independent sidebar and finger pin locking mechanisms
<p>Primus XP RESTRICTED Schlage Everest 29 R FSIC² and Conventional³</p> <p>Schlage Everest 29 S or T FSIC and Conventional</p> <ul style="list-style-type: none"> 5 levels of side bit milling exclusivity Patent protection to 2029 Independent sidebar and finger pin locking mechanisms 	<p>Primus UL 437 Option Schlage Classic Obverse Conventional</p> <p>Schlage Everest 29 R Conventional SL</p> <p>Schlage Everest 29 S or T Conventional</p> <ul style="list-style-type: none"> Hardened steel drill pins Proven pick and drill resistant Withstands extreme physical attack

COMPARABLE ELECTRONIC SECURITY – Ensure your credential is as secure as your keyway		
<p>Proximity credentials</p> <ul style="list-style-type: none"> Easily duplicated 	<p>MIFARE Classic® smart credentials</p> <ul style="list-style-type: none"> Secure encrypted data and communications Difficult to duplicate 	<p>MIFARE Plus® and MIFARE® DESFire® smart credentials</p> <ul style="list-style-type: none"> Advanced data encryption makes duplication nearly impossible Most secure credentials available from Schlage

1. Limited dealer controlled programs available.
 2. FSIC and Conventional in the form of SL cylinders that accept a 7-pin SFIC key.
 3. UL 437 available on Primus XP SL cylinders in the conventional format only.

Schlage layered security

How a key system fits into your building

Schlage key systems provide patented, restricted, and high-security solutions to help protect human safety and the valuable assets of your business. These innovative key systems are designed for flexibility and value. They allow application of open keyways alongside restricted options to appropriately address security levels

on each individual doorway while working within a single keyway system for maintenance ease and control.

You get the right levels of security where it counts in a facility-wide solution designed to accommodate your budget.

Scenario 1

An independent, personal financial investment business has moved in to an office space that was designed with Schlage locks on the Everest 29 S keyway. To assure appropriate asset protection, each space was assessed and assigned new key cylinders based on levels of security required.

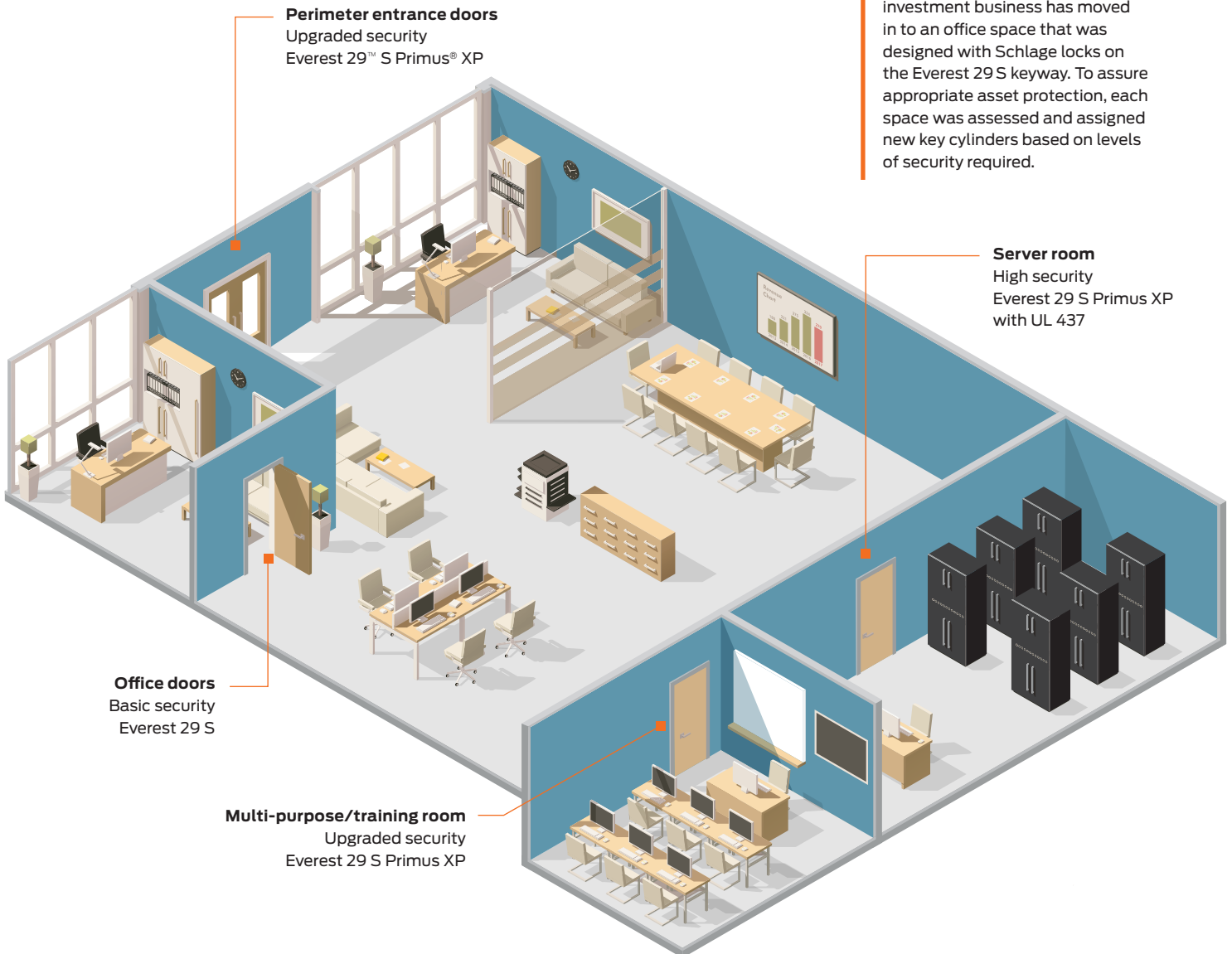

Office doors

Layer 1: Basic security
Everest 29 S

For low risk entries, use of an open keyway can offer greater convenience and management ease. Everest 29 S keys can be duplicated through any Schlage authorized locksmith.



Perimeter entrance doors

Layer 2: Upgraded security
Everest 29 S Primus XP

Even when perimeter entrances have electronic access in place, those added protections can still be bypassed at the lock cylinder. The Primus XP cylinder mechanism improves physical security and offers the best levels of Schlage key duplication control.

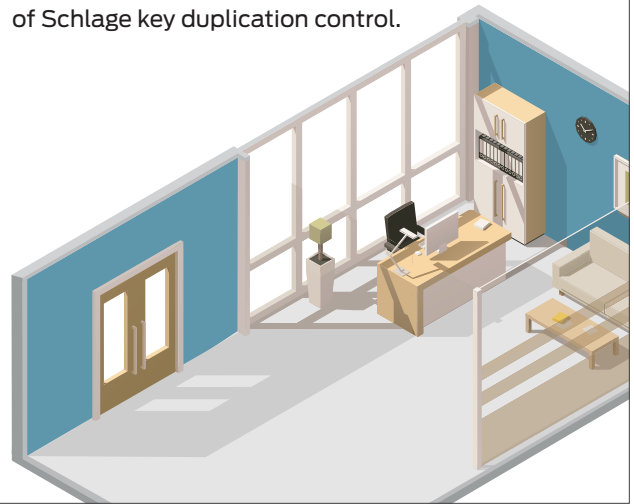

Multi-purpose/training room

Layer 2: Upgraded security
Everest 29 S Primus XP

These types of rooms tend to host a wide range of users and contain high value technology assets. Everest 29 S is an open keyway so choosing the Primus XP version makes the key opening this door restricted for improved control over key duplication.



Server room

Layer 3: High security
Everest 29 S Primus XP with UL 437

Protection of client digital information is critical to this business. The UL 437 option added to a cylinder with Primus XP further improves physical security to the highest industry standard level.

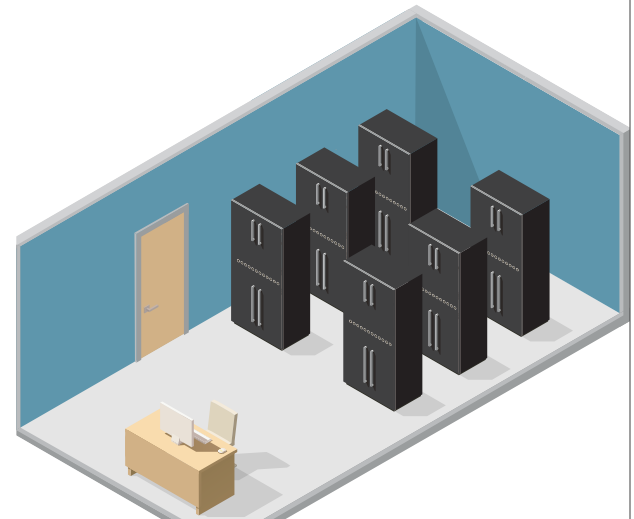

Schlage layered security

Where to begin

As you begin to define your security needs, there are three important points to consider early on. Your answers to these first few questions will likely influence the balance of choices you make.

- 1. Choose the right levels of security:** The level of security needed on your most sensitive or at risk openings will largely define how you approach other areas.
- 2. Determine the right cylinder format:** Choice of cylinder is based either on existing locksets or budget considerations when purchasing new and determines what keyway options are available.
- 3. Ensure key system and credential security continuity:** Whether or not you have, or intend to have, electronic access control in your facility may also influence your choices.

1. Choose the right levels of security

There are many levels of keyway security. How you choose to apply them in your facility depends on how strictly you need to administer key control and the degree of concern you have around physical security bypass or forced intrusion.

Begin with highest risk openings. This sets the bar for how you approach the rest of the facility. Ultimately you will assess all openings individually for the level of security needed and number of people given access.

Primus® cylinders

Most facilities are in need of higher levels of key control on at least a few openings. Large businesses with high risk assets will want to apply the greatest precautions and may opt for end user controlled Primus® cylinders with keys that can be made for their exclusive use on a national or regional basis. Mid-size and smaller facilities can gain the same benefits of key control on a more local level by engaging a locksmith who offers dealer exclusive Schlage Primus cylinders and keys.

By incorporating Primus cylinders into your security plan, you gain better administrative control and the option to add UL 437 Primus cylinders. With UL 437 you also gain Schlage's highest levels of physical security in the cylinder.

Upgrading an existing key system

Bear in mind that most previously installed Schlage key systems can be seamlessly upgraded to Primus cylinders. In particular, legacy keyway installations that are no longer under patent protection can benefit greatly on both a physical and administrative security level by adding Primus cylinders to critical points of entry.

Scenario 2

A regional hospital chain carries a costly inventory of pharmaceuticals at every facility. Other rooms also have high security needs. These may include patient record rooms, isolation rooms, and even janitorial closets containing harsh chemicals that can pose a liability risk for the hospital. Where highest security is essential, the optimum choice should provide design exclusivity, key duplication prevention, and a cylinder that deters break in.

Security	Key system solution
High security	Drug storage and patient record rooms: Patented Everest 29 T Primus XP key system with the UL 437 option purchased under a level 9Z exclusivity agreement.
Upgraded security	Isolation rooms and janitorial closets: The same patented Everest 29 T Primus XP key system but without the UL 437 option
Enhanced security	Patient and doctor rooms: Restricted Everest 29 T

Schlage layered security

2. Choose the right cylinder format

Whether your project involves new construction or an upgrade to an existing key system, Schlage offers a wide range of cylinder options. In new construction or where lock hardware is being replaced, be sure to consider the impact of long term maintenance. For retrofit, consult with your supplier or Schlage expert to determine how to best upgrade your facility.

Conventional cylinders



Full-size conventional cylinders
Designed specifically for Schlage products, these cylinders are best suited to environments where you have tight key control and little need to periodically rekey. A conventional cylinder commonly requires some disassembly of the lock for removal and replacement.

Interchangeable core cylinders

Interchangeable cores allow cylinder rekey or replacement without disassembly of the lock. They are ideal for larger campuses or facilities with high rates of occupant turnover.



Small Format Interchangeable Core (SFIC)
Based on an industry standard plug diameter, small format cores are interchangeable in most manufacturers' SFIC compatible products including Schlage, Falcon® and Best® locks. They offer a higher degree of rekeying options without replacing lock hardware.



Full Size Interchangeable Core (FSIC)
Full size cores are specific to the lock manufacturer design. They offer more flexibility when it comes to rekeying due to the speed and ease of cylinder replacement but also because they are offered in a wider range of Schlage keyways.

SL cylinders in Conventional and FSIC formats

SL cylinders are uniquely designed to accept the same Schlage A2 key system used in SFIC cylinders. This enables one key system to span three unique cylinder formats: Conventional, FSIC, and SFIC. Where a campus may have both SFIC and Schlage Conventional and/or FSIC cylinder locks in place, a single Everest 29 R family keyway can be applied. And, as a 7-pin cylinder, SL offers significantly more keying combinations than 6-pin cylinders.

3. Ensure key system and credential security continuity

In buildings where electronic access control is used, true security can only be effective if your key system plan accounts for doors where credential use is present. Most often credential access exists on common area doors and perimeter entrances where limited key distribution is desired. Many facilities also have high security areas where credential use is beneficial.

The choice of credential should reflect the highest level of key system security in the building. Credentials are like keys in that they come with varying degrees of duplication control. Any facility employing high security where both keys and credentials are in use, must ensure cohesive application of both.

Scenario 3

In the regional hospital chain previously described, electronic access solutions with credentials are also employed to enable monitoring of the use of certain rooms. These include all the high security doors.

Security	Credential solution
High security	Drug storage and patient record rooms: MIFARE® DESFire smart credential use ensures duplication risk is eliminated and user access of the rooms can be monitored and tracked over time.

The history of classic keyways

Schlage classic keyways comprise a group of four families: Obverse, Quad, Numbered and Reverse. They are among Schlage's earliest keyway designs and all but the Obverse family are considered legacy product—meaning they are no longer available for new key system set ups. All are long past the limits of patent protection, but one keyway in particular, the Obverse C keyway, has seen widespread adoption by lock OEMs in North America.

Without patent protection, keys that support basic C keyway cylinders can be copied anywhere, making administrative control of an Obverse C keyway system nearly impossible. For this reason, the Schlage standard for new key systems begins with the patented, physically secure Everest 29 keyway families. But even in buildings with out-of-patent older systems key control and upgraded physical security can be regained without the cost of a complete rekeying. The Primus® program (see page 20) offers a path to regain key control and upgrade critical points of entry to the highest levels of Schlage key system security.

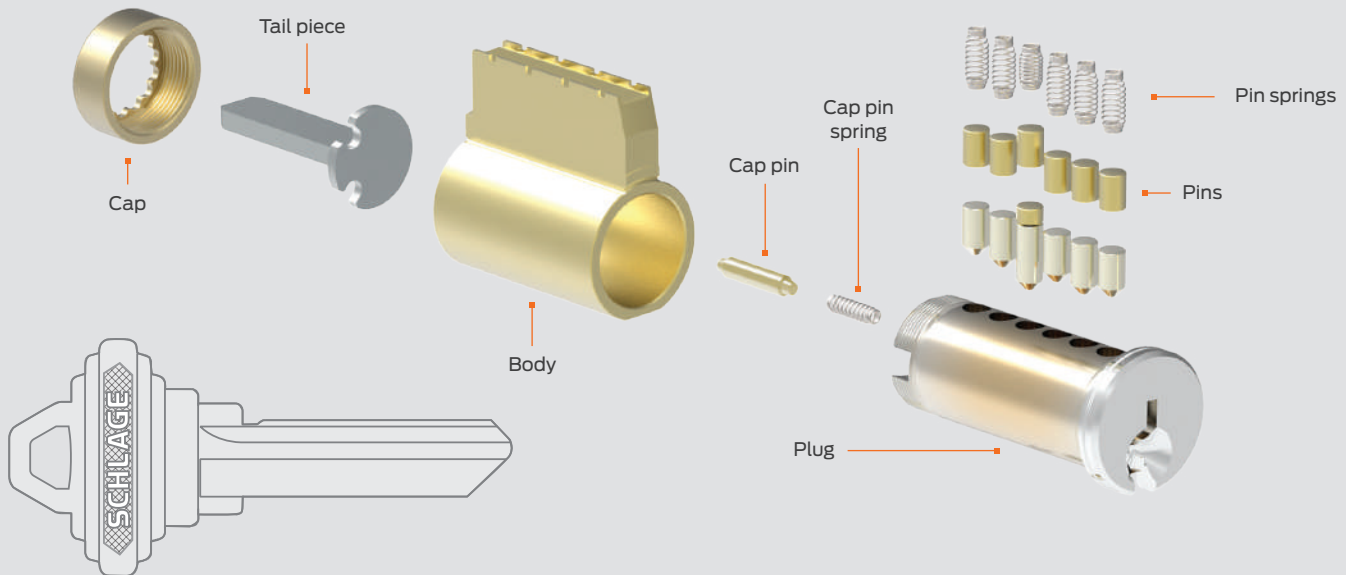

Schlage Classic keyways

Schlage Classic Obverse keyway family provides basic physical security with no restrictions on key duplication. Obverse family includes the Schlage C keyway, one of the most commonly used, open keyways in North America. Open keyways are best applied as a cost-effective solution on interior doors, but only where asset protection needs and break-in risks are low. They can also be easily upgraded using Primus RP cylinders to regain administrative control and provide high-security enhancements.

Features and benefits

Schlage Classic Obverse keyway cylinders can be used as a residential or light commercial solution where ease of duplication and readily available local servicing is desired. Keys can be duplicated at most retail key cutting services without restriction. When desired, facility security can be improved by upgrading perimeter and other high-security areas to Classic Obverse restricted Primus RP cylinders.

- Classic Obverse keyways do not require any ordering formalities
- The Obverse keyway family includes C keyway and 6 additional options
- Compatible to Schlage Classic Primus RP cylinders and keys which carry patent protection to the year 2029
- Additional drill-resistant features available with UL437 option on Primus RP version cylinders
- Available in 5- or 6-pin conventional (key-in-lever) and FSIC formats
- Cylinders available to fit an extensive list of competitor's locks
- Master keying available for all levels
- Key duplication on standard (basic) key cutting equipment
- Other legacy keyway cylinders and keys in restricted Quad, Numbered, and Reverse families continue to be available to order

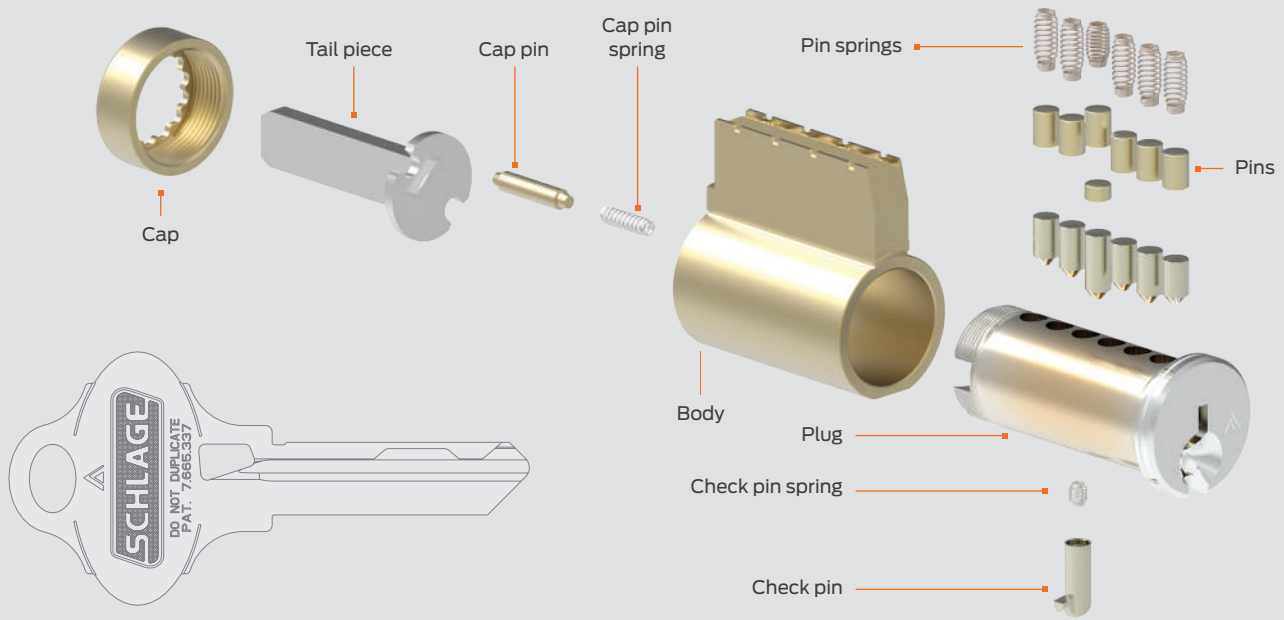

Everest 29 keyways

The essential building blocks of a well protected Schlage key system begin with Everest 29 keyways. These keyway families offer the greatest levels of versatility as part of a layered security plan and the greatest compatibility to existing Schlage and competitive locksets.

Patent protection to 2029

Everest 29 key systems protect against unauthorized duplication two ways. First, key blanks are tightly controlled by Schlage to ensure access for only authorized dealers. Secondly, patent protection deters duplication of the design—an offense subject to federal law. They are available as both open and restricted keyways to give you the level of security you need for every application.

Benefits

- Key: through-cut technology enables a unique undercut key design; 20% increase in thickness for greater strength
- Cylinder: unique check pin interaction improves physical security of the lock

Everest 29 keys work by lifting the check pin when the key is inserted into the cylinder allowing the key to turn and the lock to rotate open. This patented interaction ensures the integrity of the system at every opening.

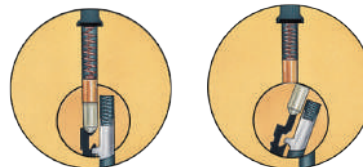

Undercut keyway profile is patented

When check pin is lifted, cylinder is free to rotate

Everest 29 keyways

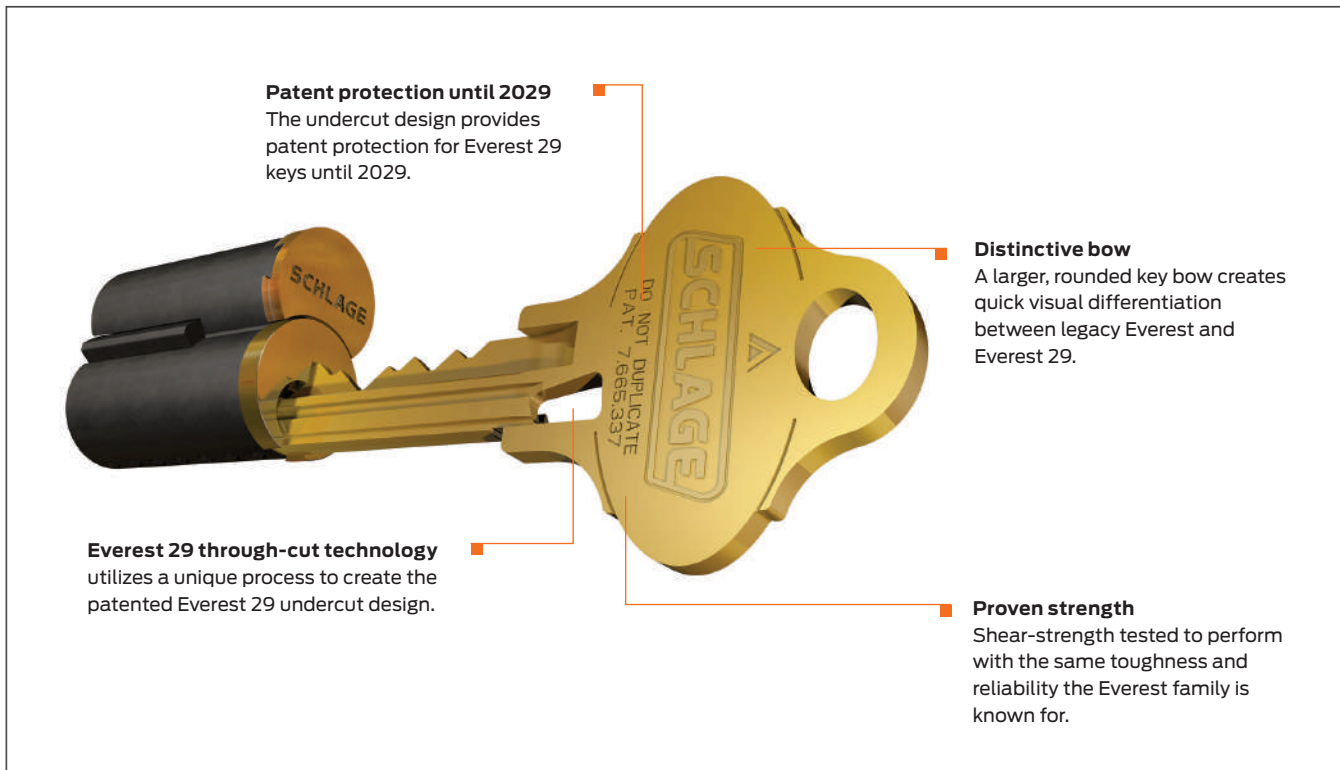

Patent protection until 2029
The undercut design provides patent protection for Everest 29 keys until 2029.

Distinctive bow
A larger, rounded key bow creates quick visual differentiation between legacy Everest and Everest 29.

Everest 29 through-cut technology
utilizes a unique process to create the patented Everest 29 undercut design.

Proven strength
Shear-strength tested to perform with the same toughness and reliability the Everest family is known for.

Best practices: Everest 29

Everest 29 is designed with both new construction and retrofit in mind. For new construction, you have the opportunity to define a full spectrum of layered security utilizing Everest 29, and Everest 29 Primus XP with and without the UL 437 option (see page 5). For retrofit applications, Everest 29 is made to be integrated into many existing systems.

- Available formats: Conventional and FSIC (S and T families); Conventional SL, FSIC SL, and SFIC (R family)
- Compatible to legacy Everest keyways
- Cylinder formats available to fit an extensive list of competitor's locks
- Multiple key sections

Upgrade legacy Everest systems

Everest 29 keyway families are each backward compatible to specific Everest B, C and D keyway families making migration of an existing key system less complex. You can selectively upgrade cylinders in your facility to regain patent protection. In both Everest and Everest 29 cylinders, Primus XP cylinder upgrades can be applied where security is most critical.

Note: Everest 29 keys will work in an existing Everest keyway, but legacy Everest keys will not work in a new Everest 29 keyway.

Compatibility

Legacy Everest ¹	Patent protected Everest 29	
B	R	<ul style="list-style-type: none"> ▪ Conventional SL, FSIC SL, and SFIC ▪ Restricted keyway ▪ Letter of authorization required
C	S ²	<ul style="list-style-type: none"> ▪ Conventional and FSIC ▪ Open keyway ▪ Duplication through authorized dealers only
D	T	<ul style="list-style-type: none"> ▪ Conventional and FSIC ▪ Restricted keyway ▪ Letter of authorization required

¹ Legacy Everest keyways are still available to order
² Everest 29 S123 is the default for Schlage commercial locks.
 Everest 29 S145 is the default keyway for new master key systems.

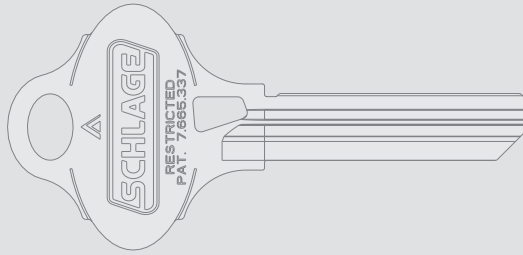
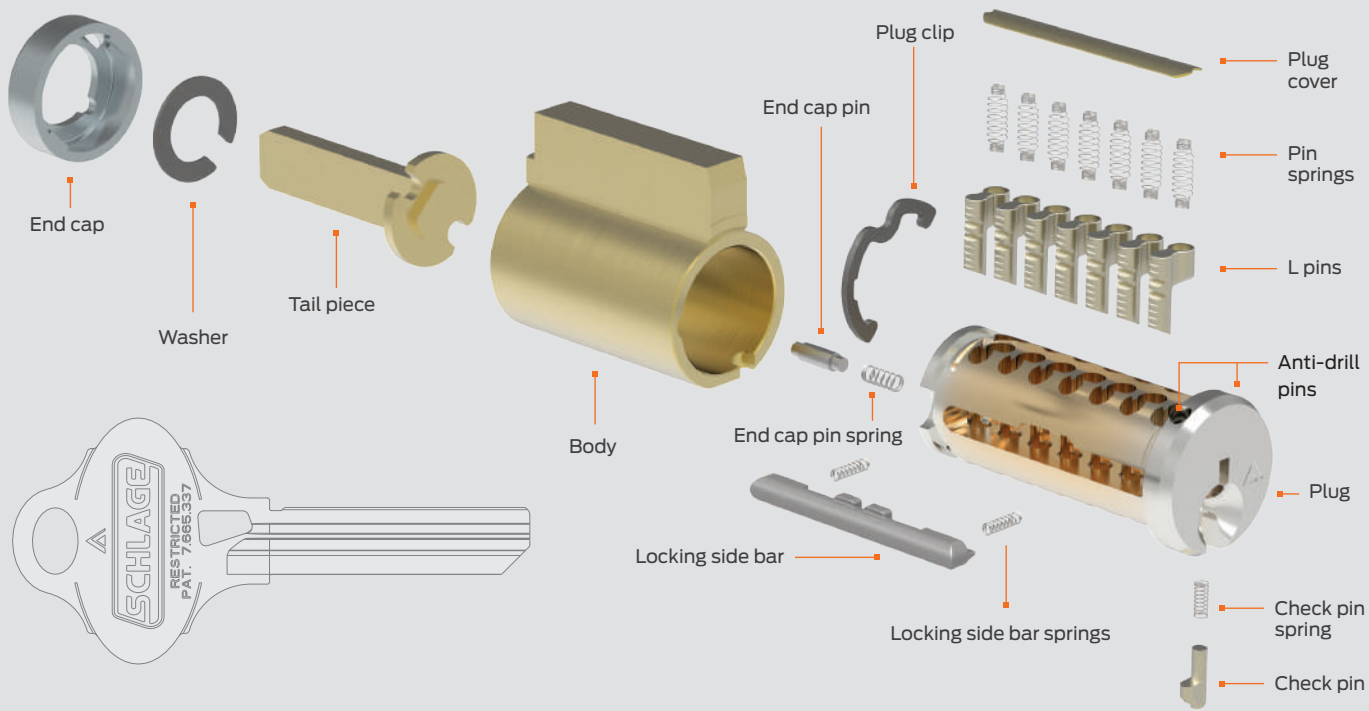

The SL advantage

The exclusive SL cylinder creates an opportunity to unify separate key systems into one restricted, A2 key system upgradeable to Primus XP security. Offered in both Conventional and Full Size Interchangeable Core (FSIC) formats, the SL cylinder utilizes the same Everest 29 R keyway family as Schlage Small Format IC cylinders.

Patented SL

A unique L-pin design allows SL cylinders to accept the 7-pin length keys common to SFIC cylinders. Security features include the check pin design of Everest 29 cylinders plus an added independent locking sidebar. In its Primus XP form, SL is the only Schlage cylinder to utilize two sidebar mechanisms making it nearly impossible to bypass.

Using SL cylinders, one key system can span three distinct formats: Conventional, FSIC and SFIC making it a cost effective solution for unifying a large campus key system. Simply replace cylinders rather than locks. You gain a more secure and manageable system in a 7-pin design that allows you the highest number of Schlage key combinations possible.

Benefits

- Allows Everest 29 R and Everest B keyway families to be compatible to all three cylinder formats
- As a 7-pin cylinder, SL offers the greatest number of Schlage keying combinations
- It creates a path to a unified, restricted key system without having to replace locks
- Enables Primus XP geographic exclusivity and physical security features to be introduced into an SFIC-based facility



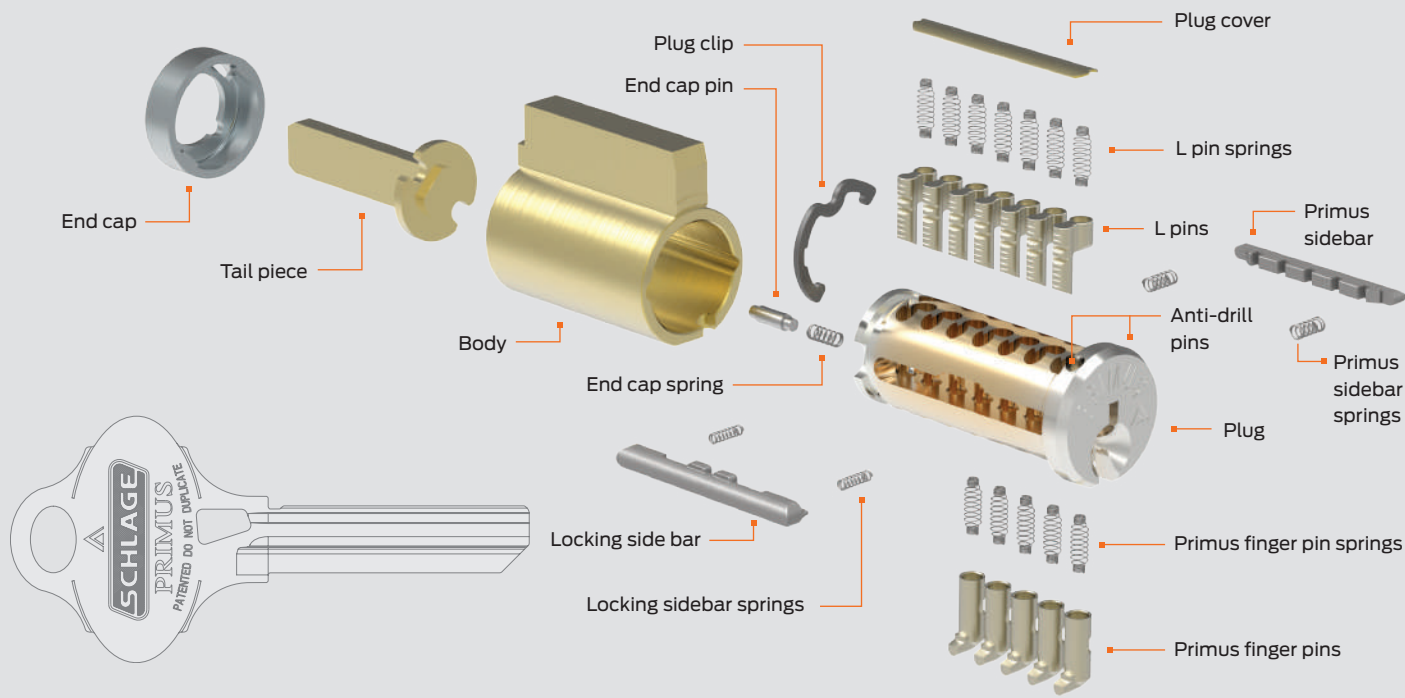

Upgradeable to Primus XP security

Best practices: SL cylinder use

In new construction with Schlage locksets, use SL on large facilities or multi-site campuses to create up to 16,384 unique key combinations per keyway. When retrofitting, locks with Conventional SL or FSIC SL cylinders can be added to an existing SFIC-formatted key system to gain the security and control of the Primus XP geographically restricted key program. Use SL anywhere a campus has a combination of SFIC cylinders and Schlage or other compatible locksets with Conventional or FSIC cylinders to unify the key system.

- Available formats: Conventional and FSIC (Everest 29 R and Everest B families)
- Key duplication on standard (basic) key cutting equipment
- SL cylinders fit all Schlage and Falcon® cylindrical locks
- Conventional SL cylinders fit Schlage modular system for use in mortise and rim applications
- Cylinders available to fit an extensive list of competitor's locks

Upgrade legacy Everest B systems

Everest 29 R keyway is backward compatible to the legacy Everest B keyway family making it possible to upgrade even older B keyway systems to Primus XP.

1. Everest 29 R family keys will work in an existing Everest B keyway, but legacy Everest B keys will not work in a new Everest 29 R keyway.

Compatibility

Legacy Everest¹ Patent protected Everest 29



- SFIC
- Restricted keyway
- Letter of authorization required

The L pin

The patented SL cylinder has a unique L pin design allowing a single, unified Everest 29 R key system to be applied to any of three cylinder formats: Conventional, FSIC and SFIC.



Everest 29 specifications

Everest 29 S family – open keyway

Everest 29 keyway families include one open keyway family—the S123 which is the default keyway for all Schlage locksets sold today.

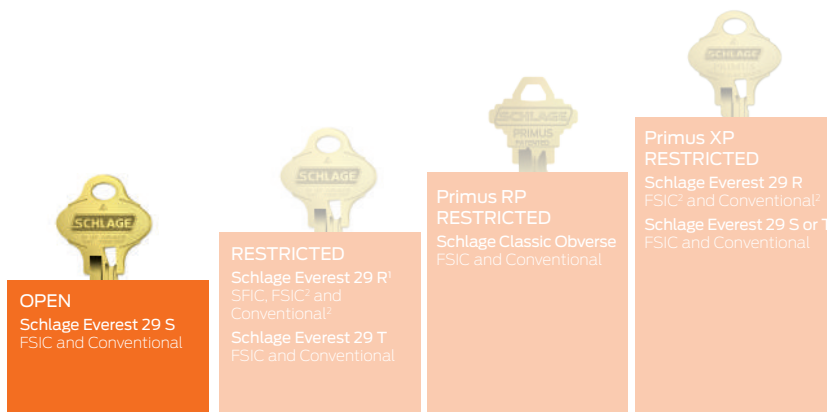

Ideal application

- Commercial use only
- Best suited to applications where the convenience of fast local key duplication is preferred with no ordering formalities

Keys

- 20% thicker key for greater strength
- Patented through-cut design
- Protected against unauthorized manufacture and distribution by U.S. patent 7,665,337 until 2029
- Keys stamped DO NOT DUPLICATE are available as an option

Cylinders/cores

- S123 keyway is provided as the default keyway on all Schlage locks unless specified otherwise
- S145 keyway is the default for master keyed products
- Full-size Conventional cylinders
- Full Size Interchangeable Cores (FSIC)
- 6-pin - cannot be interkeyed with any 5- or 7- pin cylinders
- Check pin design on the cylinder improves physical security of the lock

Compatibility

- Everest 29 S family keys are backward compatible with Everest C cylinders, but Everest C keys will not operate an Everest 29 S cylinder.
- Everest 29 S keyways are available in Primus XP high security cylinders at program levels 7, 8, and 9.

Establishing a new key system

- No ordering or set up formalities
- S145 is the default keyway for new Schlage master key systems. Additional keyways are used to expand systems which need more than one keyway

Ordering products for existing systems

Locks, cylinders, cores and keys are available through any authorized locksmith dealer or authorized distributor

Key duplication

Everest 29 S family keys can be cut on Pro-Lok's Blue Punch for Schlage (recommended). You can also use rotary cutter key machines to duplicate these keys or cut them by code. Standard Schlage depths and spacing are used, so there are no new settings for code machines.

Pin kits

Cylinders with S family keyways are compatible with all existing Schlage pin kits. Pinning Kit 40-119 is the standard Schlage commercial pin kit.

Sales samples

Sales samples of the S123 keyway are available in Conventional or FSIC cylinders. Ask your Schlage sales representative for more information.

Everest 29 specifications

Everest 29 T family – end user restricted keyway

Everest 29 keyways include two restricted keyway families. They are defined by cylinder format and method of key control.



1. Limited dealer controlled programs available.
2. FSIC and Conventional in the form of SL cylinders that accept a 7-pin SFIC key.

Ideal application

- Large facility applications where key control is most critical and can be properly managed internally
- Key cutting and cylinder servicing can be managed internally or through your trusted local locksmith provider

Keys

- 20% thicker key for greater strength
- Patented through-cut design
- Protected against unauthorized manufacture and distribution by U.S. patent 7,665,337 until 2029
- All keys are stamped DO NOT DUPLICATE

Cylinders/cores

- Full-size Conventional cylinders
- Full Size Interchangeable Cores (FSIC)
- 6-pin - cannot be interkeyed with any 5- or 7-pin cylinders
- Check pin design on the cylinder improves physical security of the lock

Compatibility

- Everest 29 T family keys are backward compatible with Everest D cylinders, but Everest D keys will not operate an Everest 29 T cylinder.
- Everest 29 T keyways are available in Primus XP high security cylinders with the flexibility to assign geographic exclusivity defined by level 9 only.

Establishing a new key system

- Use of Overtur™ Restricted Product website (<https://restrictedproduct.allegion.com>) or a letter of authorization on the end user's official stationery establishes the authorized ship-to location(s)
- Ship to locations can be specified as local Schlage authorized locksmith dealers

Ordering products for existing systems

Restricted locks, cylinders, cores and keys on each subsequent order will be drop shipped to the location specified by the end user.

Key duplication

T family keys can be cut on a special version of the Blue Punch available through Schlage as 40-099, or use rotary cutter key machines to duplicate these keys or cut them by code. Standard Schlage depths and spacing are used, so there are no new settings for code machines.

Pin kits

Cylinders with T family keyways are compatible with all existing Schlage pin kits. Pinning Kit 40-119 is the standard Schlage commercial pin kit.

Sales samples

Restricted keyways are not available as sample cylinders; however, the key and mechanism can be evaluated with an Everest 29 S family sample. The only difference is the shape of the keyway.

Everest 29 specifications

Everest 29 R family – end user restricted keyway

The Everest 29 R keyway features both end user and dealer controlled options for SFIC and Schlage SL cylinders.



1. Limited dealer controlled programs available.
2. FSIC and Conventional in the form of SL cylinders that accept a 7-pin SFIC key.

Ideal application

Best applied in large facilities with in-house locksmiths to cut keys and combine cores.

Keys

- 20% thicker key for greater strength
- Patented through-cut design
- Protected against unauthorized manufacture and distribution by U.S. patent 7,665,337 until 2029
- All keys are stamped RESTRICTED

Cylinders/cores

- Small Format Interchangeable Cores (SFIC)
- Conventional SL and FSIC SL cylinders accept the Everest 29 R keyways
- 7-pin only
- Check pin design on the cylinder improves physical security of the lock

Compatibility

- Everest 29 R family keys are backward compatible with Everest B cylinders, but Everest B keys will not operate an Everest 29 R cylinder.
- Everest 29 R keyways are available in Primus XP high security Conventional and FSIC format SL cylinders at levels 7, 8, and 9.

Establishing a new key system

- Use of Overtur™ Restricted Product website (<https://restrictedproduct.allegion.com>) or a letter of authorization on the end user's official stationery establishes the authorized ship-to location(s)
- Ship to locations can be specified as local Schlage authorized locksmith dealers

Ordering products for existing systems

Restricted keyway locks, cylinders, cores and keys on each subsequent order will be drop shipped to the location specified by the end user.

Key duplication

R family keys can be cut on a special version of the Blue Punch available through Schlage as 40-071. It is not possible to retrofit any existing Best or Blue Punches to cut B and R family keys. You can also use a rotary cutter key machine to duplicate these keys or cut them by code. The stop is at the shoulder of the key, even though the bittings are read and written tip to bow. This merely requires using new spacing specifications on existing rotary cutter code machines.

Pin kits

All Schlage small format cores are compatible with most brands of A2 system kits. However, Schlage does not recommend using Arrow™ or Kaba Peaks bottom pins in Everest cores. If you do not already have an A2 pin kit, you can purchase Schlage SFIC pin kit 40-129. SL cylinder requires use of the 40-247 pinning kit.

Sales samples

Sales sample cores have the R125 keyway. No key blanks or uncombined cores are available for samples since this is a restricted keyway. Each sample core comes with one operating key and one control key. Please specify sales samples when ordering.

Everest 29 specifications

Everest 29 R234 and R235 keyways – locksmith, contract hardware dealer, and Security Center restricted SFIC keyway option

The Everest 29 R keyway family includes two keyways dedicated to dealers. They are dealer controlled and are intended to service large facilities or multiple end user sites.

Ideal application

- R234: Sold exclusively through Schlage Authorized Security Centers for use with national accounts
- R235: Locksmiths who service large facility end users with SFIC cylinders and no on-site facility locksmith

R235: Also available to Schlage contract hardware dealers (dealers) who provide complete key cutting and master keying service to their end users and actively promote and sell SFIC restricted key systems

Keys

- No geographical exclusivity
- Dealer ID number is stamped on all keys for tracking purposes
- Keys will always be drop-shipped to dealer location

Cylinders/cores

- Small Format Interchangeable Cores (SFIC)
- Conventional SL and FSIC SL cylinders accept the Everest 29 R keyways
- 7-pin only
- Check pin design on the cylinder improves physical security of the lock

Compatibility

Everest 29 R family keys are backward compatible with Everest B cylinders, but Everest B keys will not operate an Everest 29 R cylinder.

Establishing a new key system

- R234: \$3,500 (list price) inventory order commitment and signed Everest 29 R234 agreement (For existing R235 dealers inventory order commitment of \$1,000.)

- R235: \$2,500 (list price) inventory order commitment for uncombined cores and key blanks (for existing Primus or Primus XP dealer - \$500 commitment) and signed Everest 29 R235 agreement to maintain the security of key blanks (provided by local Schlage sales manager)
- Participating locksmith, dealer or center (sellers) are assigned an ID number by Schlage which is stamped on all key blanks ordered

Ordering products for existing systems

- Provide assigned ID with order
- Blank keys are drop-shipped by Schlage directly to the seller
- Cores can be purchased through participating wholesalers and are furnished uncombined (0-bitted small format cores are not available)
- Factory master keying is available

Key duplication

- Locksmiths, dealers and centers are not permitted to cut keys for any system set up by another seller identified by the ID number on the key
- Keys must be cut by the locksmith, dealer or center – no blanks can be sold to end users or institutional locksmiths
- End users are able to purchase from originating seller only – a sole source relationship
- See detail on facing page for equipment required for key cutting

Pin kits

See detail on facing page for pinning kit information.

Classic Obverse Primus RP

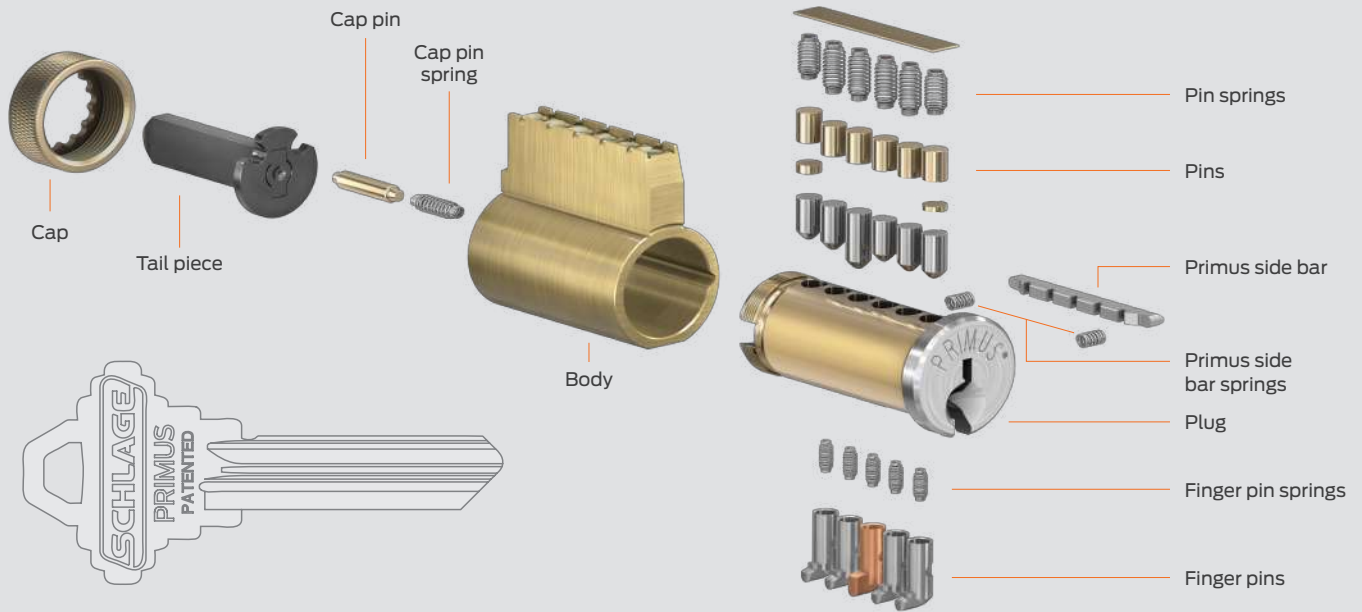

Primus security

Critical points of entry and highly sensitive areas need extra protection. Here, Schlage cylinders with added Primus features provide a "next level" layer of security that works within your existing Schlage key system. Even non-restricted key systems no longer under patent protection can regain top levels of administrative and physical security anywhere Primus cylinders are applied.

Patent protection

Primus keys and cylinders take different paths to patent protection depending on the keyway family. The Classic Obverse family, which includes the famous Schlage C keyway, carries a patent to 2029 as a Primus RP (Raised Pin) key design. The Everest 29 family in Primus XP differs in that it is the Everest 29 patent that carries to the year 2029 protecting keys and cylinder designs for all Everest 29 products including the Primus XP keys and cylinders.

Benefits

- Key: unique side bit milling designs can be assigned to dealer or end user with various levels of geographic exclusivity
- Cylinder: independent sidebar and finger pin locking mechanisms increase pick and bump resistance
- Utilizes six standard key cuts; no special key duplication equipment needed

Primus keys with their patented side bit design engage both top pins and bottom finger pins independently. The lock can only turn when the Primus sidebar fully seats onto the finger pins.

- **Traceability**
Primus keys are marked with an ID number
- **Secure**
Finger pins and sidebar operate independently from top pins

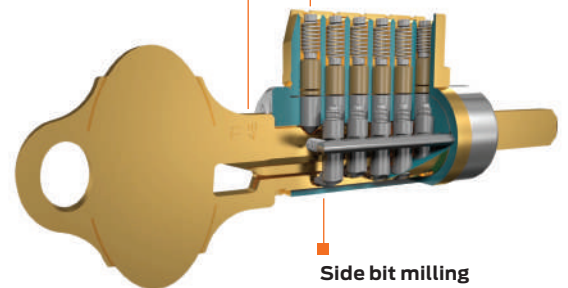

- **Side bit milling**
Keys are factory cut with unique side bit milling exclusive to customer or geography

Everest 29 Primus XP

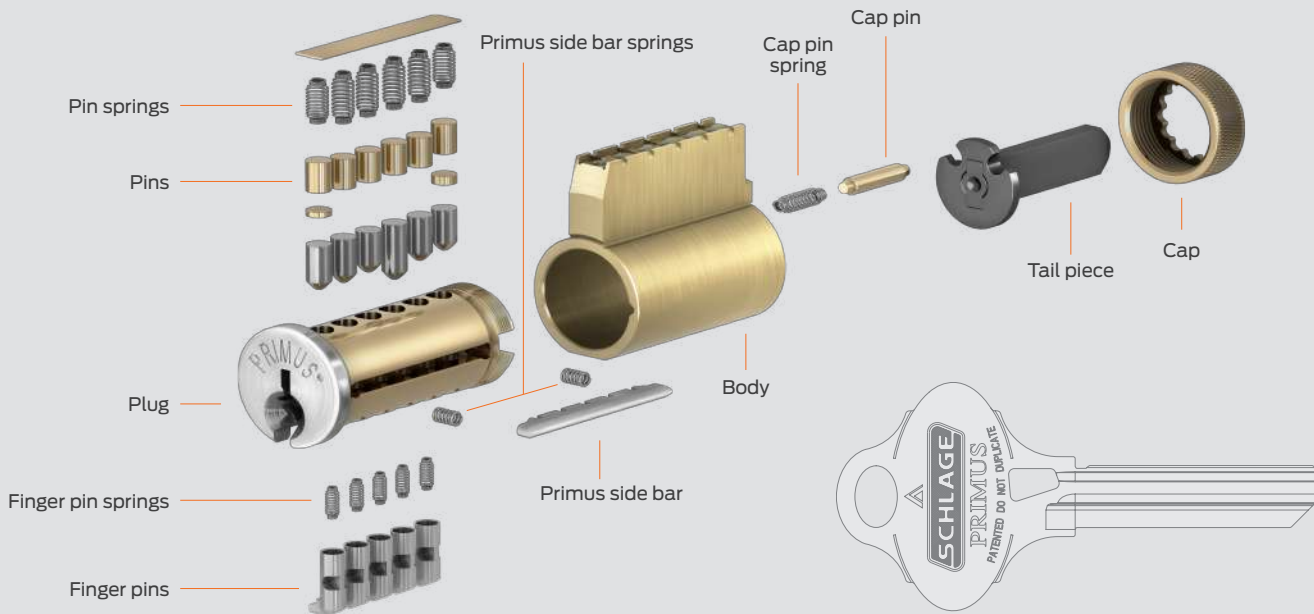

Best practices

Primus cylinders and keys help you achieve the highest levels of both physical and administrative security for critical points of entry. They can be applied anywhere human safety and asset protection is most important. Examples include perimeter doors on schools, server rooms, financial and HR record rooms, labs, IT, or government facilities. If break-in is a concern, the UL 437 option available only on Primus cylinders, can help mitigate risk.

Benefits

- Fits an extensive list of competitors' locks
- Multiple levels of master key hierarchies available



High security

Add optional UL 437 listed cylinders for the highest level of physical protection. Featuring hardened steel drill pins, they are tested and proven to be pick- and drill-resistant to withstand extreme physical attacks.

Upgrade security

Primus is compatible with all current and many legacy Schlage keyways. This allows facility upgrades to improve security while keeping the convenience of the existing single key system intact.

Primus cylinders can be keyed alike to existing compatible keyway cylinders. Here, the Primus key will work in the existing cylinders, however, non-Primus keys cannot operate the Primus cylinders.

Pathways to Primus level security

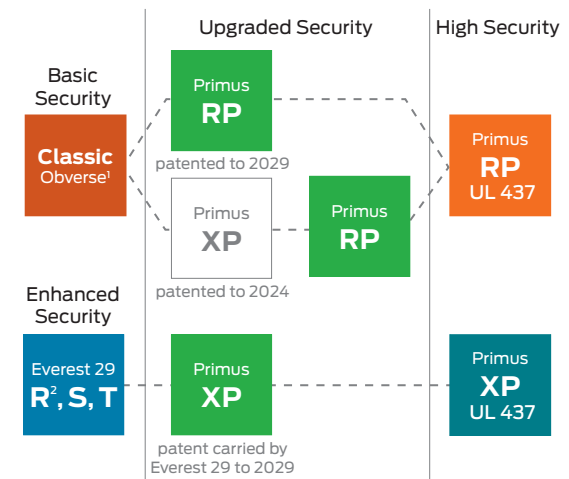

Legacy Everest keyway family upgrades

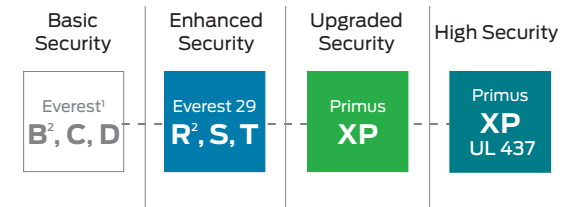

1. As open, out-of-patent keyways these should always be upgraded on critical points of entry to eliminate risk of unauthorized key duplication.
2. Everest B and Everest 29 R keyways available in Primus as SL cylinders accepting a small format A2 pinning design in Conventional or FSIC formats.

- Selection guide
- Classic
- Everest 29
- Primus**
- Cylinders | Cores
- Competitor lock cams
- Key blanks
- Equipment
- Ordering | Other



Primus security

The height of security

Among the many Schlage cylinder options, Primus products with UL 437 listed physical security improvements let you utilize the highest levels of Schlage key system security. With Primus keys you can control patented side bit milling designs with exclusivity based on geographic area to the level that best suits your security needs.

Levels and exclusivity

The Primus program features multiple levels of security. For both Classic Obverse and Everest 29 Primus systems, security increases as geographic area gets larger because opportunity diminishes for the uniquely milled key blank to be available from more than one source within the area.

At every level that is 1+ or greater, physical verification in the form of a signature or I.D. card, or digital verification through <https://restrictedproduct.allegion.com> is required. All levels utilize patent-protected Primus cylinders and keys to guard against unauthorized duplication. To select the proper level of security, consideration should be given to the degree to which key control is needed, the initial commitment, and whether key system maintenance is by a local locksmith or internally managed.

		Primus® Levels				Cylinder and key ordering process		
		Primus RP (Classic)	Primus XP (Everest 29)	Exclusivity	Commitment	End user	Dealer	Shipping
Dealer controlled	1			None	None	Order through any authorized Schlage dealer	Standard order	To dealer from distributor
	1+		7	Zip code (first 3 digits)	Formal agreement and initial Primus RP or XP inventory order	Order through originating Primus dealer only	Dealer to provide Primus I.D. and keyway section name or number	To dealer from factory
	2		8	Time zone				
End user controlled	3U		9U	Random (not exclusive)	Initial purchase of 59 or fewer cylinders	Provide signed face sheet with order specifying keyway to any Primus authorized dealer	Dealer to provide end user's Primus I.D. and keyway section name or number	End user determined
	3G		9G	Zip code (first 2 digits)	Initial purchase of 60 or more cylinders			
	4Z		9Z	Time zone	Initial purchase of 2,000 or more cylinders or alternative fee based arrangement			
	4N		9N	Nationwide	Initial purchase of 4,000 or more cylinders or alternative fee based arrangement			

Classic Primus RP purchasing and distribution exclusivity

The Classic Obverse keyway family in Primus RP cylinders provide various levels of geographic exclusivity and require authorization for duplication, ensuring better key control.

Level 1 Non-exclusive

Highlights:

- No exclusivity for side bit milling – shared by all dealers and distributors
- Dealer can purchase products from any Schlage Primus authorized dealer
- End user can purchase from any Primus Level 1 authorized dealer, no sole-source relationship

To set up a new dealer:

Submit a Classic Primus Level 1 signed agreement to the distributor

Level 1+ Zip code exclusivity based on first three digits

Highlights:

- Dealer-owned side bit milling exclusivity based on the first three digits of zip code
- Dealer can purchase products from any Schlage Primus authorized distributor
- Available to direct and indirect dealers
- Key blanks are not available to end users
- End user must purchase from originating dealer, sole-source relationship

To set up a new dealer:

- Submit Classic Primus Level 1+ signed agreement
- For dealers who are new to Primus, submit purchase order of a total of \$7500 (list) to cover both Classic and Primus inventories
- For those who are existing legacy Primus dealers, submit purchase order of a total of \$5000 (list) to cover both Classic and Primus RP inventory commitments
- For existing Primus XP dealers, no additional inventory is required

Re-ordering customers need to:

- Provide dealer ID and Primus sequence number with order
- Primus keys will always be drop-shipped to dealer location

Purchasing and distribution

Level 2 Time zone exclusivity

Highlights:

- Dealer-owned side bit milling exclusivity based on time zone
- Dealer can purchase products from any Schlage Primus authorized dealer
- Available for direct and indirect dealers
- Key blanks are not available to end users
- End user must purchase from originating dealer, sole-source relationship

To set up a new dealer:

- Submit Classic Primus Level 2 signed agreement
- For dealers who are new to Primus, submit purchase order of a total of \$25,000 (list) to cover both Classic and Primus inventories
- For existing legacy Primus dealers, submit purchase order of \$15,000 (list) to cover both Classic and Primus RP inventory commitments
- For existing Primus XP dealers, no additional inventory is required

Re-ordering customers need to:

- Provide dealer ID and Primus sequence number with order
- Primus keys will always be drop-shipped to dealer location

Levels 3 and 4 End user exclusive

These levels are for end users who may want to cut their own keys and/or must be able to obtain competitive bids on subsequent additions to their Classic Primus key system.

Highlights:

- Side bit milling is assigned to end user, not dealer, based upon commitment level
- End user is not tied to originating dealer, but can purchase from any Schlage Primus authorized dealer
- Key blanks are available for end user only
- Face sheet is required for each subsequent order

To set up a new Primus account:

- Create account through Overtur Keying - Restricted Products (<https://restrictedproduct.allegion.com/>)
- Create digital authorization, available in pdf
- Submit an order and attach digital authorization

Re-ordering customers need to:

- Overtur Keying - Restricted Products orders: attach pdf authorization from Overtur Keying with order
- For restricted accounts created prior to July 2021 which remain on manual forms: provide copy of face sheet, letter of authorization and Primus account number

Level 3U (universal) – fewer than 60 cylinders

Schlage randomly assigns a side bit milling from a small pool of combinations which may be repeated locally. There are no guarantees of geographical exclusivity.

Level 3G (geographical) – more than 60 cylinders

Schlage assigns an exclusive side bit milling based on the first two digits of the end user's zip code.

Level 4Z (time zone) – minimum of 2,000 cylinders

Inventory of 2,000 cylinders must be maintained over two years or pay a fee. End user buys exclusivity of one side bit milling within his time zone and country.

Level 4N (nationwide) – minimum of 4,000 cylinders

Inventory of 4,000 cylinders must be maintained over two years or pay a fee. End user buys nationwide exclusivity of one side bit milling.

Everest 29 Primus XP purchasing and distribution exclusivity

When you upgrade your Everest 29 key system to Primus XP cylinders and keys, you automatically move up to one of our three highest security levels: 7, 8 or 9. These levels offer different methods of distribution and purchasing that are important to understand when choosing a key system that meets your needs for flexibility, security, and ongoing service and maintenance.

Levels 7 and 8 Dealer exclusive

Locksmith/dealer invests in a side bit milling that will be exclusive to him on a zip code- or time zone-based geographic area. Dealers sign an agreement that ensures the integrity of the system and, among other things, prohibits the dealer from cutting other dealers' keys. Each dealer is assigned a unique ID number that is stamped on all keys. They sell product with this side bit milling to their end user customers.

The dealer then issues an ID card to each end user and verifies orders for duplicate keys against the signature panel on the card.

Highlights:

- Dealer-owned side bit milling exclusivity
- End user must purchase from originating dealer, sole-source relationship
- Available to direct and indirect dealers
- Product can be purchased from any Schlage Primus authorized wholesale distributor

To set up a new Primus XP account:

- An Everest Primus XP signed agreement must be submitted
- An initial inventory purchase must be made
- Dealer to provide dealer ID and key section with order
- Primus keys and assembled cylinders will always be drop-shipped direct to dealer from the factory
- Unassembled cylinders and cylinder parts can be purchased through wholesale distributor

Details and purchase order commitments

Level 7 (zip code)

Schlage will assign an exclusive side bit milling based on the first three digits of the locksmith/dealer's primary physical location zip code.

Initial purchase requirement (list price)

- New Primus XP dealers: \$7,500
- Primus dealers upgrading to Primus XP: \$5,000

Level 8 (time zone)

Schlage will assign an exclusive side bit milling based on the dealer's time zone and country.

Initial purchase requirement (list price)

- New Primus XP dealers: \$25,000
- Primus dealers upgrading to Primus XP: \$15,000

Purchasing and distribution

Level 9 End user exclusive

This level is for end users who may want to cut their own keys and/or must be able to obtain competitive bids on subsequent additions to their Everest 29 Primus XP key system. Level 9 is subdivided to provide varying degrees of side bit milling exclusivity, depending on the amount of cylinders purchased, and is comparable to Classic Primus RP levels 3 and 4.

Highlights:

- Side bit milling assigned to end user, not dealer, based upon commitment level
- End user is not tied to originating dealer, but can purchase from any Schlage authorized Primus dealer
- Key blanks are available for end user only
- Manage authorizations for restricted keys and cylinders through Overtur Keying - Restricted Products secure portal
- Authorizing documents are required for all subsequent orders
- Available in Everest 29 S and Everest 29 T keyway families
- Available in small format (A2) keying in Everest 29 R keyway family as Primus XP SL cylinders in Conventional or FSIC formats

To set up a new Primus account:

- Create account through Overtur Keying - Restricted Products (<https://restrictedproduct.allegion.com/>)
- Create digital authorization, available in pdf.
- Submit an order and attach digital authorization

Re-ordering customers need to:

- Overtur Keying - Restricted Products orders: attach pdf authorization from Overtur Keying with order
- For restricted accounts created prior to July 2021 which remain on manual forms: provide copy of face sheet, letter of authorization and Primus account number

Level 9U (universal)

End user buys fewer than 60 cylinders and may share a side bit milling with another small end user in the same area.

Level 9G (geographical)

End user buys 60 cylinders or more; Schlage assigns a side bit milling exclusive within the first two digits of the end user's zip code.

Level 9Z (time zone)

End user buys a minimum of 2,000 Primus cylinders over a two-year period or buys the exclusivity outright; Schlage assigns a side bit milling exclusive within the end user's time zone. Inventory must be maintained over two years or pay a fee.

Level 9N (nationwide)

End user buys a minimum of 4,000 Primus cylinders over a two-year period or pays for the exclusivity outright; Schlage assigns a nationwide exclusive side bit milling. The end user is free to purchase Level 9 Primus XP products from any Schlage Primus dealer nationwide, rather than being tied to a sole source dealer.

Modular, conventional cylinders fit your needs

Schlage conventional cylinders offer extreme versatility in a modular design. One full-size conventional cylinder can be applied for any Schlage key-in-lever, rim or mortise need. You save on inventory costs and gain flexibility on the job.

- The modular cylinder design can accept any Schlage keyway
- Solid brass bar stock cylinder construction and hardened stainless steel housings
- Rear mortise housings are available in 1/8" increments to allow for a full range of cylinder lengths, 1 1/8" to 1 3/4"
- Fits all Schlage locksets and deadbolts
- 13 mortise and rim face finish options, six mortise housing lengths, one rim housing, four plug face finishes, six tail pieces and nine cam options create a thousand potential cylinder configurations

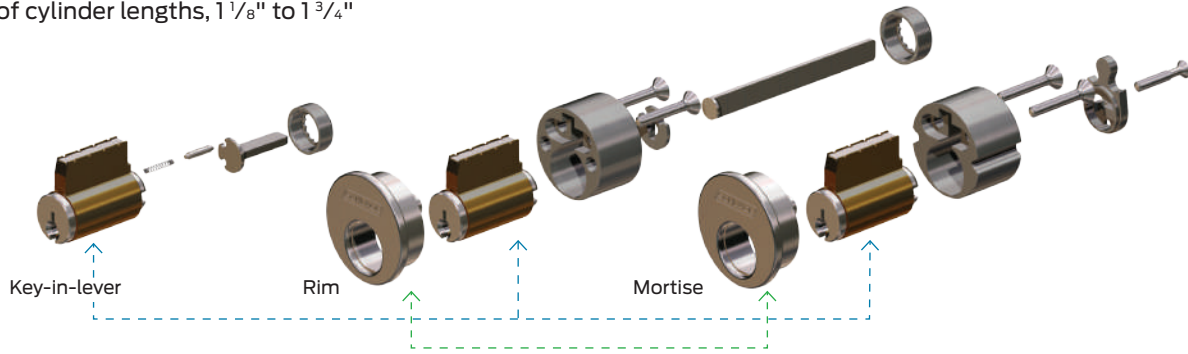

Parts

Modular cylinders use fewer parts because the cylinder and a small number of screws, cams and plug extensions can be universally applied. The majority of parts are simply the rear housings in various lengths and finishes.

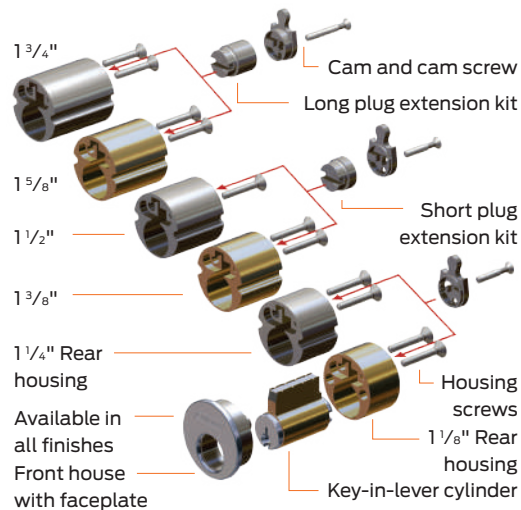

Mortise and rim front housing finish options



Conventional cylinders for Schlage locksets

Security	Key mechanism	Pins	Patent protected keyway families	Grade 1 Series locks		Grade 2 Series locks	
				AD/CO	ND	ALX	A (knob locks)
Basic security Open keyways	Standard pin and tumbler	6	— ¹	23-013 (cylindrical)	23-065 23-000 (faculty restroom)	21-020 23-195 (classroom)	21-002 (non-Orbit) 21-003 (non-Orbit faculty restroom) 21-002-122 (Orbit) 21-003-168 (Orbit faculty restroom)
	Check pin	6	S (Everest 29)	23-118 ² (mortise & exits)			
Enhanced security Restricted use	Check pin	6	T (Everest 29)	23-013 (cylindrical) 23-118 ² (mortise & exits)	23-065 23-000 (faculty restroom)	20-020 23-195 (classroom)	21-002 (non-Orbit) 21-003 (non-Orbit faculty restroom) 21-002-122 (Orbit) 21-003-168 (Orbit faculty restroom)
	SL	7	R (Everest 29)	91-017 (cylindrical) 91-019 ² (mortise & exits)	91-018 ³	91-018 91-118 (classroom)	91-004 ³ (non-Orbit) 91-005 ³ (Orbit)
Upgraded security Primus level restricted use, geographic exclusivity, and independent sidebar	Legacy Primus	6	S, T (Everest 29)	20-750 (cylindrical) 20-854 ² (mortise & exits)	20-765 ³	20-728 ⁴	20-724 ³ (non-Orbit) 20-724-122 ³ (Orbit)
	Primus RP	6	Obverse ¹ (Classic)	20-750-RP (cylindrical) 20-854-RP ² (mortise & exits)	20-765-RP ³	20-728-RP ⁴	20-724-RP ³ (non-Orbit) 20-724-122-RP ³ (Orbit)
	Primus XP	6	S, T (Everest 29)	20-750-XP (cylindrical) 20-854-XP ² (mortise & exits)	20-765-XP ³	20-728-XP ⁴	20-724-XP ³ (non-Orbit) 20-724-122-XP ³ (Orbit)
High security All Primus benefits plus added UL 437 physical security	Primus XP SL	7	R (Everest 29)	91-715-XP (cylindrical) 91-721-XP ² (mortise & exits)	91-718-XP ³	91-718-XP ⁴	91-704-XP ³ (non-Orbit) 91-705-XP ³ (Orbit)
	Legacy Primus	6	S, T (Everest 29)	20-550 (cylindrical) 20-554 ² (mortise & exits)	20-565 ³	20-528 ⁴	20-524 ³ (non-Orbit) 20-524-122 ³ (Orbit)
	Primus RP	6	Obverse ¹ (Classic)	20-550-RP (cylindrical) 20-554-RP ² (mortise & exits)	20-565-RP ³	20-528-RP ⁴	20-524-RP ³ (non-Orbit) 20-524-122-RP ³ (Orbit)
	Primus XP	6	S, T (Everest 29)	20-550-XP (cylindrical) 20-554-XP ² (mortise & exits)	20-565-XP ³	20-528-XP ⁴	20-524-XP ³ (non-Orbit) 20-524-122-XP ³ (Orbit)
	Primus XP SL	7	R (Everest 29)	91-515-XP (cylindrical) 91-521-XP ² (mortise & exits)	91-518-XP ³	91-518-XP ⁴	91-504-XP ³ (non-Orbit) 91-505-XP ³ (Orbit)

1. Out-of-patent keyways like Classic Obverse are available. Obverse, however, can gain patent protection in a Primus RP or XP cylinder. RP is recommended because patent coverage carries to 2029 versus 2024 for Primus XP.
 2. For exits with Athens levers use cylindrical cylinder.
 3. No Faculty Restroom function cylinder available.
 4. No Classroom function cylinder available.

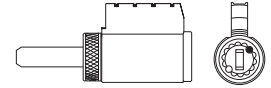

Vertical tailpiece for lever locks - length will vary by lock and function



AD and CO Series electronic locks



ND Series locks



ALX Series locks

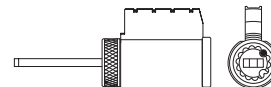

Horizontal tailpiece for knob lock



A Series locks

Conventional cylinders for Schlage locksets

Security	Key mechanism	Pins	Patent protected keyway families	Tubular locks	Interconnected locks		Deadlocks
				S	S200 ²	CS210	B250 (cylinder only)
Basic security Open keyways	Standard pin and tumbler	6	— ¹	21-059	21-059 (keyed levers) 22-081 (deadbolts)	22-093	22-002 ³
	Check pin	6	S (Everest 29)				
Enhanced security Restricted use	Check pin	6	T (Everest 29)	21-059	21-059 (keyed levers) 22-081 (deadbolts)	22-093	22-002
	SL	7	R (Everest 29)	91-007	91-007 (keyed levers) 91-012 (deadbolts)	91-013	91-008
Upgraded security Primus level restricted use, geographic exclusivity, and independent sidebar	Legacy Primus	6	S, T (Everest 29)	20-752	20-752 (keyed levers) 24-769 (deadbolts)	—	20-729
	Primus RP	6	Obverse ¹ (Classic)	20-752-RP	20-752-RP (keyed levers) 24-769-RP (deadbolts)	—	20-729-RP
	Primus XP	6	S, T (Everest 29)	20-752-XP	20-752-XP (keyed levers) 24-769-XP (deadbolts)	—	20-729-XP
	Primus XP SL	7	R (Everest 29)	91-722-XP	91-722-XP (keyed levers) 91-729-XP (deadbolts)	—	91-707-XP
High security All Primus benefits plus added UL 437 physical security	Legacy Primus	6	S, T (Everest 29)	20-552	20-552 (keyed levers) 24-569 (deadbolts)	—	20-529
	Primus RP	6	Obverse ¹ (Classic)	20-552-RP	20-552-RP (keyed levers) 24-569-RP (deadbolts)	—	20-529-RP
	Primus XP	6	S, T (Everest 29)	20-552-XP	20-552-XP (keyed levers) 24-569-XP (deadbolts)	—	20-529-XP
	Primus XP SL	7	R (Everest 29)	—	91-529-XP (deadbolts)	—	91-507-XP

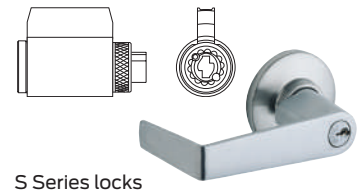

S Series locks

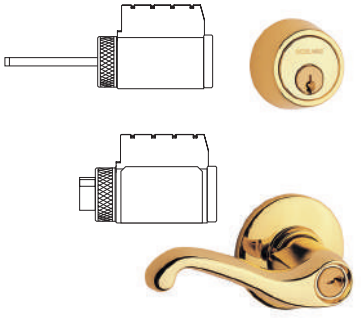

S200 Series interconnect locks

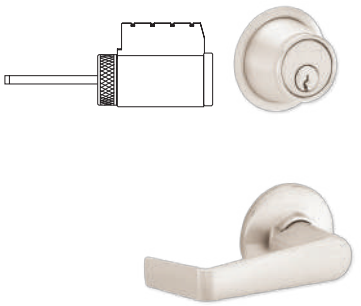

CS200 Series interconnect locks

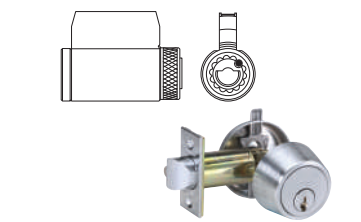

B250 Series deadlatches

1. Out-of-patent keyways like Classic Obverse are available. Obverse, however, can gain patent protection in a Primus RP or XP cylinder. RP is recommended because patent coverage carries to 2029 versus 2024 for Primus XP.
 2. For locks manufactured before March 2008 use B250 Series deadlock cylinders.
 3. 5-pin cylinders available in Classic Obverse C, CE, E, and F keyways only. Order part number 22-001.

Plug face finish options



- Satin Brass (606)
- Matte Black (622)
- Satin Chrome (626)
- Aged Bronze (643e)

Conventional cylinders

Conventional cylinders for Schlage portable security

Security	Key mechanism	Pins	Patent protected keyway families	Cabinet/drawer locks	Padlocks	Locking cables
				CL	KS	KC
Basic security Open keyways	Standard pin and tumbler	6	– ¹	20-172 (door) 20-174 (drawer)	47-413	47-414
	Check pin	6	S (Everest 29)			
Enhanced security Restricted use	Check pin	6	T (Everest 29)	20-172 (door) 20-174 (drawer)	47-413	47-414
	SL	7	R (Everest 29)	91-001 (door) 91-002 (drawer)	–	–
Upgraded security Primus level restricted use, geographic exclusivity, and independent sidebar	Legacy Primus	6	S, T (Everest 29)	20-772 (door) 20-774 (drawer)	47-743	47-744
	Primus RP	6	Obverse ¹ (Classic)	20-772-RP (door) 20-774-RP (drawer)	47-743-RP	47-744-RP
	Primus XP	6	S, T (Everest 29)	20-772-XP (door) 20-774-XP (drawer)	47-743-XP	47-744-XP
	Primus XP SL	7	R (Everest 29)	91-719-XP (door) 91-720-XP (drawer)	–	–
High security All Primus benefits plus added UL 437 physical security	Legacy Primus	6	S, T (Everest 29)	20-572 (door) 20-574 (drawer)	47-542	47-543
	Primus RP	6	Obverse ¹ (Classic)	20-572-RP (door) 20-574-RP (drawer)	47-542-RP	47-543-RP
	Primus XP	6	S, T (Everest 29)	20-572-XP (door) 20-574-XP (drawer)	47-542-XP	47-543-XP
	Primus XP SL	7	R (Everest 29)	91-519-XP (door) 91-520-XP (drawer)	–	–

1. Out-of-patent keyways like Classic Obverse are available. Obverse, however, can gain patent protection in a Primus RP or XP cylinder. RP is recommended because patent coverage carries to 2029 versus 2024 for Primus XP.

Plug face finish options

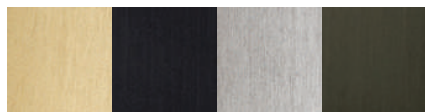

Satin Brass (606)	Matte Black (622)	Satin Chrome (626)	Aged Bronze (643e)
-------------------	-------------------	--------------------	--------------------

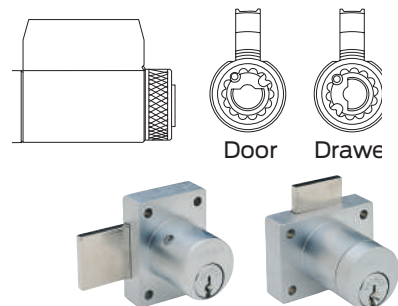

CL Series cabinet and drawer locks

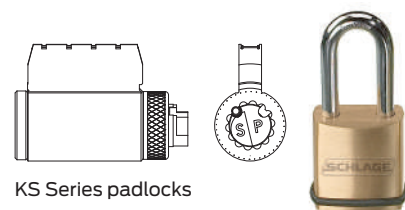

KS Series padlocks

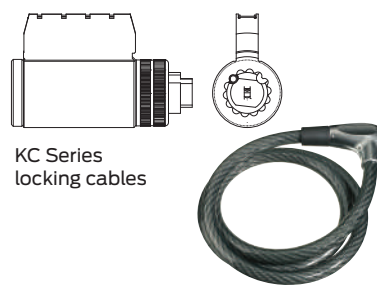

KC Series locking cables

Conventional cylinders for Schlage deadbolts

B600 Series

Security	Key mechanism	Pins	Patent protected keyway families	Function	Single cylinder functions	Double cylinder ² function 62
Basic security Open keyways	Standard pin and tumbler	6	— ¹	60, 63	22-644 (1 3/8"-2 1/2" doors)	22-085 (1 3/8"-2" doors) 22-086 (>2"-2 1/2" doors)
	Check pin	6	S (Everest 29)	61, 64	22-642 (1 3/8"-2" doors) 22-643 (>2"-2 1/2" doors)	
Enhanced security Restricted use	Check pin	6	T (Everest 29)	60, 63	22-644 (1 3/8"-2 1/2" doors)	22-085 (1 3/8"-2" doors) 22-086 (>2"-2 1/2" doors)
	SL	7	R (Everest 29)	60, 63	91-032 (1 3/8"-2 1/2" doors)	
				61, 64	91-030 (1 3/8"-2" doors) 91-031 (>2"-2 1/2" doors)	91-028 (1 3/8"-2" doors) 91-029 (>2"-2 1/2" doors)

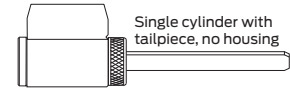
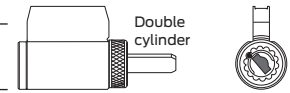

B700 Series

Upgraded security Primus level restricted use, geographic exclusivity, and independent sidebar	Legacy Primus	6	S, T (Everest 29)	60, 63	20-744 (1 3/8"-2 1/2" doors)	20-745 (1 3/8"-2" doors) 20-746 (>2"-2 1/2" doors)
				61, 64	20-742 (1 3/8"-2" doors) 20-743 (>2"-2 1/2" doors)	
				60, 63	20-744-RP (1 3/8"-2 1/2" doors)	
	Primus RP	6	Obverse ¹ (Classic)	60, 63	20-742-RP (1 3/8"-2" doors)	20-745-RP (1 3/8"-2" doors) 20-746-RP (>2"-2 1/2" doors)
				61, 64	20-743-RP (>2"-2 1/2" doors)	
	Primus XP	6	S, T (Everest 29)	60, 63	20-744-XP (1 3/8"-2 1/2" doors)	20-745-XP (1 3/8"-2" doors) 20-746-XP (>2"-2 1/2" doors)
61, 64				20-742-XP (1 3/8"-2" doors) 20-743-XP (>2"-2 1/2" doors)		
Primus XP SL	7	R (Everest 29)	60, 63	91-711-XP (1 3/8"-2 1/2" doors)	91-712-XP (1 3/8"-2" doors) 91-713-XP (>2"-2 1/2" doors)	
			61, 64	91-709-XP (1 3/8"-2" doors) 91-710-XP (>2"-2 1/2" doors)		

B800 Series

High security All Primus benefits plus added UL 437 physical security	Legacy Primus	6	S, T (Everest 29)	60, 63	20-544 (1 3/8"-2 1/2" doors)	20-545 (1 3/8"-2" doors) 20-546 (>2"-2 1/2" doors)
				61, 64	20-542 (1 3/8"-2" doors) 20-543 (>2"-2 1/2" doors)	
				60, 63	20-544-RP (1 3/8"-2 1/2" doors)	
	Primus RP	6	Obverse ¹ (Classic)	60, 63	20-542-RP (1 3/8"-2" doors)	20-545-RP (1 3/8"-2" doors) 20-546-RP (>2"-2 1/2" doors)
				61, 64	20-543-RP (>2"-2 1/2" doors)	
	Primus XP	6	S, T (Everest 29)	60, 63	20-544-XP (1 3/8"-2 1/2" doors)	20-545-XP (1 3/8"-2" doors) 20-546-XP (>2"-2 1/2" doors)
				61, 64	20-542-XP (1 3/8"-2" doors) 20-543-XP (>2"-2 1/2" doors)	
	Primus XP SL	7	R (Everest 29)	60, 63	91-536-XP (1 3/8"-2 1/2" doors)	91-532-XP (1 3/8"-2" doors) 91-533-XP (>2"-2 1/2" doors)
61, 64				91-534-XP (1 3/8"-2" doors) 91-535-XP (>2"-2 1/2" doors)		

1. Out-of-patent keyways like Classic Obverse are available. Obverse, however, can gain patent protection in a Primus RP or XP cylinder. RP is recommended because patent coverage carries to 2029 versus 2024 for Primus XP.
2. Part numbers for double-sided deadbolts represent one cylinder only.

Conventional cylinders

Conventional cylinders for Schlage deadbolts

B500 Series Grade 2 deadbolts			Patent protected keyway families	Function	Single cylinder functions	Double cylinder ² function 62	
Security	Key mechanism	Pins					
Basic security Open keyways	Standard pin and tumbler	6	– ¹	60, 63	22-003 (1 3/8"-1 3/4" doors) 22-004 (>1 3/4"-2 1/4" doors)	22-645 (1 3/8"-1 3/4" doors) 22-646 (>1 3/4"-2 1/4" doors)	
	Check pin	6	S (Everest 29)	61	22-069 (1 3/8"-2 1/4" doors)		
Enhanced security Restricted use	Check pin	6	T (Everest 29)	60, 63	22-003 (1 3/8"-1 3/4" doors) 22-004 (>1 3/4"-2 1/4" doors)	22-645 (1 3/8"-1 3/4" doors) 22-646 (>1 3/4"-2 1/4" doors)	
	SL	7	R (Everest 29)	60, 63	91-009 (1 3/8"-1 3/4" doors) 91-010 (>1 3/4"-2 1/4" doors)		
Upgraded security Primus level restricted use, geographic exclusivity, and independent sidebar	Legacy Primus	6	S, T (Everest 29)	60, 63	20-188 (1 3/8"-1 3/4" doors) 20-189 (>1 3/4"-2 1/4" doors)	20-745 (1 3/8"-1 3/4" doors) 20-746 (>1 3/4"-2 1/4" doors)	
	Primus RP	6	Obverse ¹ (Classic)	60, 63	20-188-RP (1 3/8"-1 3/4" doors) 20-189-RP (>1 3/4"-2 1/4" doors)		20-745-RP (1 3/8"-1 3/4" doors) 20-746-RP (>1 3/4"-2 1/4" doors)
				61,	20-071-RP (1 3/8"-2 1/4" doors)		
	Primus XP	6	S, T (Everest 29)	60, 63	20-188-XP (1 3/8"-1 3/4" doors) 20-189-XP (>1 3/4"-2 1/4" doors)		20-745-XP (1 3/8"-1 3/4" doors) 20-746-XP (>1 3/4"-2 1/4" doors)
Primus XP SL	7	R (Everest 29)	60, 63	91-702-XP (1 3/8"-1 3/4" doors) 91-703-XP (>1 3/4"-2 1/4" doors)			
High security All Primus benefits plus added UL 437 physical security	Legacy Primus	6	S, T (Everest 29)	60, 63	20-190 (1 3/8"-1 3/4" doors) 20-191 (>1 3/4"-2 1/4" doors)	20-545 (1 3/8"-1 3/4" doors) 20-546 (>1 3/4"-2 1/4" doors)	
	Primus RP	6	Obverse ¹ (Classic)	60, 63	20-190-RP (1 3/8"-1 3/4" doors) 20-191-RP (>1 3/4"-2 1/4" doors)		20-545-RP (1 3/8"-1 3/4" doors) 20-546-RP (>1 3/4"-2 1/4" doors)
				61	20-072-RP (1 3/8"-2 1/4" doors)		
	Primus XP	6	S, T (Everest 29)	60, 63	20-190-XP (1 3/8"-1 3/4" doors) 20-191-XP (>1 3/4"-2 1/4" doors)		20-545-XP (1 3/8"-1 3/4" doors) 20-546-XP (>1 3/4"-2 1/4" doors)
				61	20-072-XP (1 3/8"-2 1/4" doors)		
	Primus XP SL	7	R (Everest 29)	60, 63	91-502-XP (1 3/8"-1 3/4" doors) 91-503-XP (>1 3/4"-2 1/4" doors)		91-512-XP (1 3/8"-2" doors)
61				91-501-XP (1 3/8"-2 1/4" doors)			

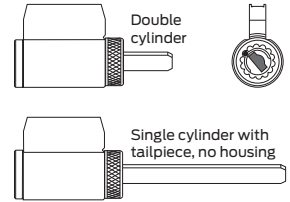

1. Out-of-patent keyways like Classic Obverse are available. Obverse, however, can gain patent protection in a Primus RP or XP cylinder. RP is recommended because patent coverage carries to 2029 versus 2024 for Primus XP.
 2. Part numbers for double-sided deadbolts represent one cylinder only.

Mortise cylinders for Schlage L and HL Series locks

Security	Key mechanism	Pins	Patent protected keyway families	Functions	Full-face cylinders for L and N escutcheons	Concealed body cylinder for L escutcheon	Cylinders for sectional (rose) trim
					L Series	L Series	L and HL
Basic security	Standard pin and tumbler	6	— ¹	All except below	30-021	30-004	30-001
				L9060 outside	26-021 ²	26-023	20-001 ²
	Open keyways	6	S (Everest 29)	LM9280, LM/LMV9380 storeroom	30-019	--	30-000 ⁵
L9485, L9486 ⁴ faculty restroom/hotel				30-022 ³	30-005 ³	30-002 ³	
Enhanced security	Check pin	6	T (Everest 29)	All except below	30-021	30-004	30-001
				L9060 outside	26-021 ²	26-023	20-001 ²
				LM9280, LM/LMV9380 storeroom	30-019	--	30-000 ⁵
	Restricted use	6	T (Everest 29)	L9485, L9486 ⁴ faculty restroom/hotel	30-022 ³	30-005 ³	30-002 ³
				All except below	30-021	30-004	30-001
	SL	7	R (Everest 29)	L9060 outside	91-063	--	91-062
LM9280, LM/LMV9380 storeroom				91-059	--	91-051	
LM9280, LM/LMV9380 storeroom				91-130 (1 1/4")	--	91-129 (1 1/8")	
Upgraded security	Legacy Primus	6	S, T (Everest 29)	All except below	20-793	20-789	20-787
				L9060 outside	20-701 ²	24-767	20-700 ²
				LM9280, LM/LMV9380, L9485, L9486	--	--	--
Primus level restricted use, geographic exclusivity, and independent sidebar	Primus RP	6	Obverse ¹ (Classic)	All except below	20-793-RP	20-789-RP	20-787-RP
				L9060 outside	20-701-RP ²	24-767-RP	20-700-RP ²
				LM9280, LM/LMV9380, L9485, L9486	--	--	--
Primus XP	6	S, T (Everest 29)	All except below	20-793-XP	20-789-XP	20-787-XP	
			L9060 outside	20-701-XP ²	24-767-XP	20-700-XP ²	
			LM9280, LM/LMV9380, L9485, L9486	--	--	--	
Primus XP SL	7	R (Everest 29)	All except below	91-760-XP	--	91-757-XP	
			L9060 outside	91-754-XP	--	91-751-XP	
			LM9280, LM/LMV9380, L9485, L9486	--	--	--	
High security	Legacy Primus	6	S, T (Everest 29)	All except below	20-593	20-589	20-587
				L9060 outside	20-501 ²	24-567	20-500 ²
				LM9280, LM/LMV9380, L9485, L9486	--	--	--
	Primus RP	6	Obverse ¹ (Classic)	All except below	20-593-RP	20-589-RP	20-587-RP
				L9060 outside	20-501-RP ²	24-567-RP	20-500-RP ²
	Primus XP	6	S, T (Everest 29)	All except below	20-593-XP	20-589-XP	20-587-XP
L9060 outside				20-501-XP ²	24-567-XP	20-500-XP ²	
LM9280, LM/LMV9380, L9485, L9486				--	--	--	
Primus XP SL	7	R (Everest 29)	All except below	--	--	91-557-XP	
			L9060 outside	91-564-XP	--	91-751-XP	
Primus XP SL	7	R (Everest 29)	LM9280, LM/LMV9380, L9485, L9486	--	--	--	

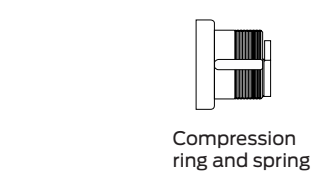
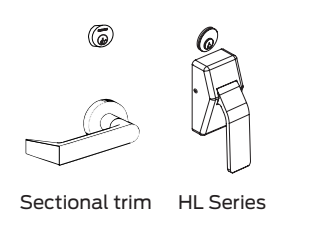
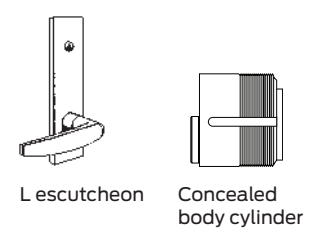
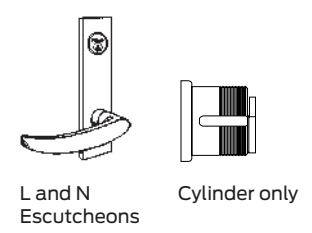

1. Out-of-patent keyways like Classic Obverse are available. Obverse, however, can gain patent protection in a Primus RP or XP cylinder. RP is recommended because patent coverage carries to 2029 versus 2024 for Primus XP.
 2. For L9060 outside applications that may require a longer cam - use L583-941 (1 1/8", 1 3/8", 1 1/2") and L583-942 (1 1/4", 1 1/2", 1 3/4").
 3. Specify handing for faculty restroom/hotel cylinders.
 4. L9486 available in Sectional (Rose)trim only.
 5. Includes the L/LV9081 Accessible Storeroom function.
 Note: 1 1/8" length standard. Optional lengths available in 1/8" (4mm) increments up to 1 3/4" (44mm).

Selection guide
Classic
Everest 29
Primus
Cylinders | Cores
Competitor lock cams
Key blanks
Equipment
Ordering | Other

Conventional cylinders

Cams for all Schlage L Series functions

Schlage L Series (except L9060 outside) cams - Current
(cylinders made after August 2010)



L583-474
Modular cylinder
lengths 1 1/8",
1 3/8" and 1 5/8"



L583-475
Modular cylinder
lengths 1 1/4", 1 1/2"
and 1 3/4"

Von Duprin and other straight cam applications (Schlage L9060 outside) - Current
(cylinders made after August 2010)



L583-476
Modular cylinder
lengths 1 1/8",
1 3/8" and 1 5/8"



L583-477
Modular cylinder
lengths 1 1/4", 1 1/2"
and 1 3/4"

SL cylinders - Schlage L Series (except L9060 outside) cams

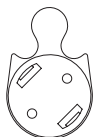

L583-800
Modular SL
cylinder length 1 1/8"

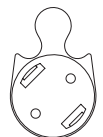

L583-801
Modular SL
cylinder length 1 1/4"

SL cylinders - Von Duprin and other straight cam applications (Schlage L9060 outside)



L583-802
Modular SL
cylinder length 1 1/8"

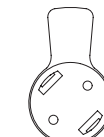

L583-803
Modular cylinder
SL cylinder length 1 1/4"

Schlage L Series (except L9060 outside) cams - non-modular
(cylinders made before August 2010)

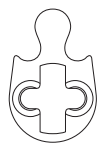

L583-254
Classic keyways



L583-153
Everest and Primus

Von Duprin and other straight cam applications (Schlage L9060 outside) - non-modular
(cylinders made before August 2010)

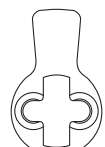

B502-191
Classic
keyways



B502-948
Everest and Primus

Mortise and rim front housing finish options

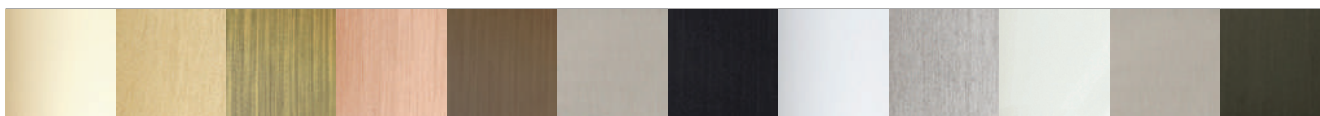

Bright Brass (605)	Satin Brass (606)	Antique Brass (609)	Satin Bronze (612)	Oil Rubbed Bronze (613)	Satin Nickel (619)	Matte Black (622)	Bright Chrome (625)	Satin Chrome (626)	Bright Stainless Steel (629)	Satin Stainless Steel (630)	Aged Bronze (643e)
Faceplate	Faceplate and plug	Faceplate	Faceplate	Faceplate	Faceplate	Faceplate and plug	Faceplate	Faceplate and plug	Faceplate	Faceplate	Faceplate and plug

Cylinders to use with rim, mortise exit and competitive devices

Security	Key mechanism	Pins	Patent protected keyway families	Schlage rim cylinders for exit devices			Schlage mortise cylinders for Von Duprin and other straight cam applications	
				Cylinder (horizontal tailpiece)	Cylinder (vertical tailpiece)	Lockout cylinder (horizontal tailpiece)	Cylinder with compression ring, spring and blocking ring	Cylinder with compression ring and spring
Basic security Open keyways	Standard pin and tumbler	6	— ¹	20-022	20-021	—	20-002	20-001
	Check pin	6	S (Everest 29)					
Enhanced security Restricted use	Check pin	6	T (Everest 29)	20-022	20-021	—	20-002	20-001
	SL	7	R (Everest 29)	91-075	91-074	—	91-052	91-051
Upgraded Security Primus level restricted use, geographic exclusivity, and independent sidebar	Legacy Primus	6	S, T (Everest 29)	20-710	20-709	20-716	20-703	20-700
	Primus RP	6	Obverse ¹ (Classic)	20-710-RP	20-709-RP	20-716-RP	20-703-RP	20-700-RP
	Primus XP	6	S, T (Everest 29)	20-710-XP	20-709-XP	20-716-XP	20-703-XP	20-700-XP
	Primus XP SL	7	R (Everest 29)	91-775-XP	91-774-XP	—	91-752-XP	91-751-XP
High security All Primus benefits plus added UL 437 physical security	Legacy Primus	6	S, T (Everest 29)	20-510	20-509	20-516	20-503	20-500
	Primus RP	6	Obverse ¹ (Classic)	20-510-RP	20-509-RP	20-516-RP	20-503-RP	20-500-RP
	Primus XP	6	S, T (Everest 29)	20-510-XP	20-509-XP	20-516-XP	20-503-XP	20-500-XP
	Primus XP SL	7	R (Everest 29)	91-575-XP	91-574-XP	—	91-562-XP	91-561-XP



Security	Key mechanism	Pins	Patent protected keyway families	Adams Rite ² MS, 4500 and 4700 Series; Lori 4500 Series and Corbin Russwin DL3000 Series deadlocks			Adams Rite ² 4070 deadbolt
				Cylinder only	Lockout function ³	Cylinder with 3/8" blocking ring	Cylinder only
Basic security Open Keyways	Standard pin and tumbler	6	— ¹	26-072	--	20-013	26-073
	Check pin	6	S (Everest 29)				
Enhanced security Restricted Use	Check pin	6	T (Everest 29)	26-072	--	20-013	26-073
	SL	7	R (Everest 29)	91-060	--	91-054	91-061
Upgraded security Primus level restricted use, geographic exclusivity, and independent sidebar	Legacy Primus	6	S, T (Everest 29)	--	20-718	20-706	20-708
	Primus RP	6	Obverse ¹ (Classic)	--	20-718-RP	20-706-RP	20-708-RP
	Primus XP	6	S, T (Everest 29)	--	20-718-XP	20-706-XP	20-708-XP
	Primus XP SL	7	R (Everest 29)	91-758-XP	--	91-755-XP	91-759-XP
High security All Primus benefits plus added UL 437 physical security	Legacy Primus	6	S, T (Everest 29)	--	20-518	20-506	20-508
	Primus RP	6	Obverse ¹ (Classic)	--	20-518-RP	20-506-RP	20-508-RP
	Primus XP	6	S, T (Everest 29)	--	20-518-XP	20-506-XP	20-508-XP
	Primus XP SL	7	R (Everest 29)	91-558-XP	--	91-555-XP	91-559-XP

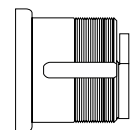

Cylinder only

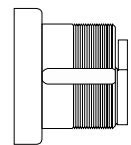

Cylinder with compression ring and spring (lockout function)

1. Out-of-patent keyways like Classic Obverse are available. Obverse, however, can gain patent protection in a Primus RP or XP cylinder. RP is recommended because patent coverage carries to 2029 versus 2024 for Primus XP.
 2. All cylinders include a set screw pack (B220-050) for Adams Rite locks.
 3. Includes cylinder, compression ring and spring. Lockout keys must be ordered separately and lockout cylinders will not be master keyed by Schlage.
 Note: 1 1/8" length standard. Optional lengths available in 1/8" (4mm) increments up to 1 3/4" (44mm).

Conventional cylinders

Cylinders for other manufacturers' products

Corbin Russwin

CL3300

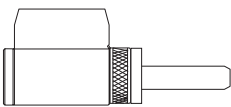

CK4200, and UT5200
(since 1963)

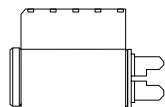

Sargent

7L, 8L, and 10L
(levers)

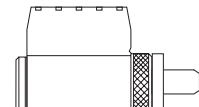

7, 8, and 9
(knobs)

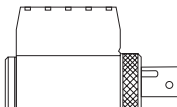

Yale

5300LN, 5400LN, 6400LN
(levers)

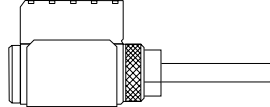

CL3400 and CL3600

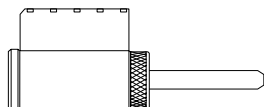

6L (except B knob)

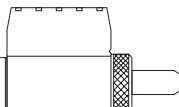

5300, 5400, 6200 (knobs)

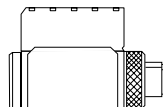

Security	Key mechanism	Pins	Patent protected keyway families	Corbin Russwin	Sargent	Yale	
Basic security	Standard pin and tumbler	6	— ¹	24-022 (CL3300) 24-139 (CL3400, CL3600) 24-127 (CK4200, UT5200)	24-119 (7L, 8L, 10L levers) 24-120 (7, 8, 9 knobs) 24-126 (6 except B knobs)	24-147 (5300LN, 5400LN, 6400LN levers) 24-123 (5300, 5400, 6200 knobs)	
	Open keyways	Check pin	6	S (Everest 29)			
Enhanced security	Check pin	6	T (Everest 29)	24-022 (CL3300) 24-139 (CL3400, CL3600) 24-127 (CK4200, UT5200)	24-119 (7L, 8L, 10L levers) 24-120 (7, 8, 9 knobs) 24-126 (6 except B knobs)	24-147 (5300LN, 5400LN, 6400LN levers) 24-123 (5300, 5400, 6200 knobs)	
	Restricted use	SL	7	R (Everest 29)	91-020 (CL3300) 91-027 (CL3400, CL3600) —	91-042 (7L, 8L, 10L levers) 91-043 (7, 8, 9 knobs) 91-045 (6 except B knobs)	91-046 (5300LN, 5400LN, 6400LN levers) 91-044 (5300, 5400, 6200 knobs)
Upgraded security	Legacy Primus	6	S, T (Everest 29)	20-762 (CL3300) 20-739 (CL3400, CL3600) 20-727 (CK4200, UT5200)	20-719 (7L, 8L, 10L levers) 20-720 (7, 8, 9 knobs) 20-726 (6 except B knobs)	20-747 (5300LN, 5400LN, 6400LN levers) 20-723 (5300, 5400, 6200 knobs)	
	Primus level restricted use, geographic exclusivity, and independent sidebar	Primus RP	6	Obverse ¹ (Classic)	20-762-RP (CL3300) 20-739-RP (CL3400, CL3600) 20-727-RP (CK4200, UT5200)	20-719-RP (7L, 8L, 10L levers) 20-720-RP (7, 8, 9 knobs) 20-726-RP (6 except B knobs)	20-747-RP (5300LN, 5400LN, 6400LN levers) 20-723-RP (5300, 5400, 6200 knobs)
		Primus XP	6	S, T (Everest 29)	20-762-XP (CL3300) 20-739-XP (CL3400, CL3600) 20-727-XP (CK4200, UT5200)	20-719-XP (7L, 8L, 10L levers) 20-720-XP (7, 8, 9 knobs) 20-726-XP (6 except B knobs)	20-747-XP (5300LN, 5400LN, 6400LN levers) 20-723-XP (5300, 5400, 6200 knobs)
		Primus XP SL	7	R (Everest 29)	91-720-XP (CL3300) 91-708-XP (CL3400, CL3600) —	91-742-XP (7L, 8L, 10L levers) 91-743-XP (7, 8, 9 knobs) 91-745-XP (6 except B knobs)	91-746-XP (5300LN, 5400LN, 6400LN levers) 91-744-XP (5300, 5400, 6200 knobs)
High security	Legacy Primus	6	S, T (Everest 29)	20-562 (CL3300) 20-539 (CL3400, CL3600) 20-527 (CK4200, UT5200)	20-519 (7L, 8L, 10L levers) 20-520 (7, 8, 9 knobs) 20-526 (6 except B knobs)	20-547 (5300LN, 5400LN, 6400LN levers) 20-523 (5300, 5400, 6200 knobs)	
	All Primus benefits plus added UL 437 physical security	Primus RP	6	Obverse ¹ (Classic)	20-562-RP (CL3300) 20-539-RP (CL3400, CL3600) 20-527-RP (CK4200, UT5200)	20-519-RP (7L, 8L, 10L levers) 20-520-RP (7, 8, 9 knobs) 20-526-RP (6 except B knobs)	20-547-RP (5300LN, 5400LN, 6400LN levers) 20-523-RP (5300, 5400, 6200 knobs)
		Primus XP	6	S, T (Everest 29)	20-562-XP (CL3300) 20-539-XP (CL3400, CL3600) 20-527-XP (CK4200, UT5200)	20-519-XP (7L, 8L, 10L levers) 20-520-XP (7, 8, 9 knobs) 20-526-XP (6 except B knobs)	20-547-XP (5300LN, 5400LN, 6400LN levers) 20-523-XP (5300, 5400, 6200 knobs)
		Primus XP SL	7	R (Everest 29)	— 91-508-XP (CL3400, CL3600) —	91-542-XP (7L, 8L, 10L levers) 91-543-XP (7, 8, 9 knobs) 91-545-XP (6 except B knobs)	91-546-XP (5300LN, 5400LN, 6400LN levers) 91-544-XP (5300, 5400, 6200 knobs)

1. Out-of-patent keyways like Classic Obverse are available. Obverse, however, can gain patent protection in a Primus RP or XP cylinder. RP is recommended because patent coverage carries to 2029 versus 2024 for Primus XP.
Note: Other manufacturers' registered trade names are for identification and reference only.

Full size interchangeable core (FSIC) applications

A full size interchangeable core (FSIC) is usually manufacturer specific and cannot interchange with competitive cores.



A Series
Orbit design



AD Series



ALX Series
All designs
except Saturn

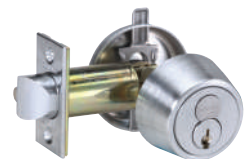

B250 Series



B500 Series



B600/700/800 Series



CL Series



CO Series



CS210



HL Series



KS Series



L Series
all designs except
concealed



ND Series lever



S Series
all designs
except Flair



S200 Series
all designs for S210

All except Flair for
other functions

Full size interchangeable cores

FSIC cylinders for Schlage and other manufacturers' locksets

Schlage FSIC cylinders (core only)

Security	Key mechanism	Pins	Patent protected keyway families	With logo	Less logo
Basic security Open keyways	Standard pin and tumbler	6	— ¹	23-030 30-120 ² (L9485/9486 faculty restroom)	23-031 30-121 ² (L9485/9486 faculty restroom)
	Check pin	6	S (Everest 29)		
Enhanced security Restricted use	Check pin	6	T (Everest 29)	23-030 30-120 ² (L9485/9486 faculty restroom)	23-031 30-121 ² (L9485/9486 faculty restroom)
	SL	7	R (Everest 29)	91-161	91-162
Upgraded security Primus level restricted use, geographic exclusivity, and independent sidebar	Legacy Primus	6	S, T (Everest 29)	20-740	20-741
	Primus RP	6	Obverse ¹ (Classic)	20-740-RP	20-741-RP
	Primus XP	6	S, T (Everest 29)	20-740-XP	20-741-XP
	Primus XP SL	7	R (Everest 29)	91-861-XP	91-862-XP

1. Out-of-patent keyways like Classic Obverse are available. Obverse, however, can gain patent protection in a Primus RP or XP cylinder. RP is recommended because patent coverage carries to 2029 versus 2024 for Primus XP.
2. Specify handing for faculty restroom/hotel cylinders.

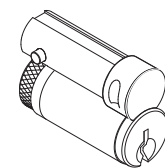
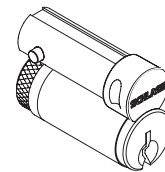

FSIC housings for Schlage bored deadbolts and deadlocks, less core

Lockset series	Description	Number	Specify finish
B500 Series	Outside	B610-203 (single) B610-205 (double)	605, 606, 609, 612, 613, 619, 625, 626, and 643e
	Inside	B610-028 ¹	See note below
B250	Outside	22-061	605, 606, 609, 613, 625, 626
	Inside of B252	22-062	
S200 Series	Outside	S306-135	605, 606, 609, 612, 613, 625, 626
B600 / 700 Series	Outside	B610-203 (single) B610-205 (double)	605, 606, 609, 612, 613, 619, 625, 626, 643e
	Inside	B610-028	See note below

Specify finish of B610-031 inside snap-on faceplate ordered separately for B662/762, and B562.

1. Inside housing does not include snap-on faceplate.

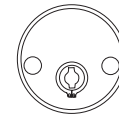
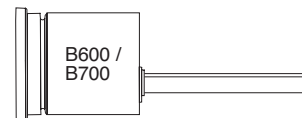
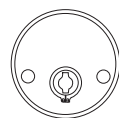
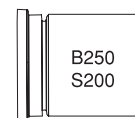
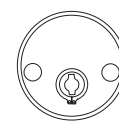
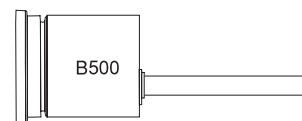

Competitive LFIC formats in Schlage Everest 29 keyways

Security	Key mechanism	Pins	Patent protected Everest 29 keyway families	Corbin Russwin ¹	Sargent ¹
Basic security	Check pin	6	S	47492854	47492846
Enhanced security Restricted use	Check pin	6	T		
Upgraded security Primus level restricted	Primus XP	6	S, T	47505697	47505672

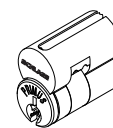

47505697

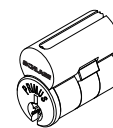

47505672

1. Use existing lock tailpiece driver. IMPORTANT: Primus installation will require field modification of driver. NOTE: LFIC are the competitive equivalent of Schlage FSIC formats).

FSIC mortise cylinders for Schlage L and HL Series locks



L & N escutcheons (cylinders with compression ring)

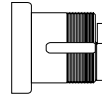

Compression ring and spring



Sectional trim (cylinder with compression ring, spring and 3/8" blocking ring)

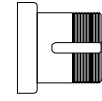

Compression ring and spring

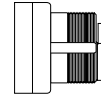

With blocking ring

Security	Key mechanism	Pins	Patent protected keyway families	Functions	L and N Escutcheons (cylinder with compression ring and spring)	Sectional (rose) trim (cylinder with compression ring, spring, and 3/8" blocking ring)
					L Series	L and HL Series
Basic security Open keyways	Standard pin and tumbler	6	- ¹	All except below	30-008	30-138
	Check pin	6	S (Everest 29)	L9060 outside	30-030	30-030 + 36-082-050 ³
				L/LV9081, LM9280, LM/LMV9380	26-101 ²	26-101 ² + 36-082-037 ⁴
Enhanced security Restricted use	Check pin	6	T (Everest 29)	All except below	30-008	30-138
				L9060 outside	30-030	30-030 + 36-082-050 ³
				L/LV9081, LM9280, LM/LMV9380	26-101 ²	26-101 ² + 36-082-037 ⁴
SL	7	R (Everest 29)	All except below	91-163	91-169	
			L9060 outside	91-165	91-165 + 36-082-050 ³	
			L9485, L9486 faculty restroom/hotel	-	-	
Upgraded Security Primus level restricted use, geographic exclusivity, and independent sidebar	Legacy Primus	6	S, T (Everest 29)	All except below	20-798	20-776
	Primus RP	6	Obverse ¹ (Classic)	L9060 outside	20-782	20-783
				L9485, L9486 faculty restroom/hotel	-	-
Primus XP	6	S, T (Everest 29)	All except below	20-798-XP	20-776-XP	
			L9060 outside	20-782-XP	20-783-XP	
			L9485, L9486 faculty restroom/hotel	-	-	
Primus XP SL	7	R (Everest 29)	All except below	91-863-XP	91-869-XP	
			L9060 outside	91-865-XP	91-865-XP + 36-082-050 ³	
			L9485, L9486 faculty restroom/hotel	-	-	
Housing less core				All except below	30-007	30-137
				L9060 outside	30-032 + 36-083	30-032 + 36-083 + 36-082-050 ³
				L/LV9081, LM9280, LM/LMV9380	26-102	26-102 + 36-082-037 ⁴



L583-255
Cam for all functions except L9060 outside



K510-680
Cam for L9060 outside

1. Out-of-patent keyways like Classic Obverse are available. Obverse, however, can gain patent protection in a Primus RP or XP cylinder. RP is recommended because patent coverage carries to 2029 versus 2024 for Primus XP.
 2. Specify handing.
 3. L9060 requires a 1/2" blocking ring (part 36-082-050).
 4. LM9280, LM/LMV9380 and L/LV9081 require a 3/8" blocking ring (part 36-082-037).
 Note: all cylinders are 1 1/2" long.

Full size interchangeable cores

FSIC cylinders to use with rim and mortise exit devices

Security	Key mechanism	Pins	Patent protected keyway families	Rim cylinders for exit devices	Mortise cylinders for Von Duprin and other straight cam applications	
				Core and housing	Cylinder with compression ring, spring and blocking ring	Cylinder with compression ring and spring
Basic security Open keyways	Standard pin and tumbler	6	- ¹	20-057	20-061	26-091
	Check pin	6	S (Everest 29)			
Enhanced security Restricted use	Check pin	6	T (Everest 29)	20-057	20-061	26-091
	SL	7	R (Everest 29)	91-170	91-173	91-171
Upgraded security Primus level restricted use, geographic exclusivity, and independent sidebar	Legacy Primus	6	S, T (Everest 29)	20-757	20-771	20-763
	Primus RP	6	Obverse ¹ (Classic)	20-757-RP	20-771-RP	20-763-RP
	Primus XP	6	S, T (Everest 29)	20-757-XP	20-771-XP	20-763-XP
	Primus XP SL	7	R (Everest 29)	91-870-XP	91-873-XP	91-871-XP
Housing less core				20-079	26-094	26-064

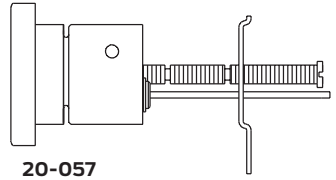

1. Out-of-patent keyways like Classic Obverse are available. Obverse, however, can gain patent protection in a Primus RP or XP cylinder. RP is recommended because patent coverage carries to 2029 versus 2024 for Primus XP.

Security	Key mechanism	Pins	Patent protected keyway families	Adams Rite MS, 4500 and 4700 Series, Lori 4500 Series, and Corbin Russwin DL3000 Series deadlocks/deadlatches	Adams Rite 4070 deadbolt	
				Cylinder with compression ring, spring and 3/16" plus 3/8" blocking rings	Cylinder with compression ring and spring	Cylinder with compression ring, spring and 3/16" plus 3/8" blocking rings
Basic security Open keyways	Standard pin and tumbler	6	- ¹	20-062	26-098	20-091
	Check pin	6	S (Everest 29)			
Enhanced security Restricted use	Check pin	6	T (Everest 29)	20-062	26-098	20-091
	SL	7	R (Everest 29)	91-174	91-172	91-175
Upgraded security Primus level restricted use, geographic exclusivity, and independent sidebar	Legacy Primus	6	S, T (Everest 29)	20-766	--	20-722
	Primus RP	6	Obverse ¹ (Classic)	20-766-RP	--	20-722-RP
	Primus XP	6	S, T (Everest 29)	20-766-XP	--	20-722-XP
	Primus XP SL	7	R (Everest 29)	91-874-XP	--	91-875-XP
Housing less core				20-060 ²	--	20-090 ²



K510-711
Adams Rite MS cam



B520-378
Adams Rite 4070 cam

1. Out-of-patent keyways like Classic Obverse are available. Obverse, however, can gain patent protection in a Primus RP or XP cylinder. RP is recommended because patent coverage carries to 2029 versus 2024 for Primus XP.
 2. Housing only - does not come with compression ring, spring, or blocking ring.

Small format interchangeable cores

Small format interchangeable core (SFIC) application

A small format interchangeable core (SFIC) has a universal design and can replace any other SFIC.



AD Series



ALX Series
All designs except Saturn



B500 Series



B600 Series



CL Series



CO Series



HL Series



KC Series



KS Series

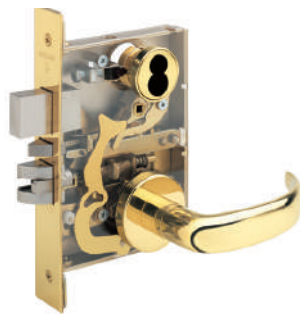

L Series
all designs except concealed



ND Series lever

Small format interchangeable cores

SFIC cylinders for Schlage locksets and exits

SFIC cylinders (core only)			Patent protected keyway families	Combinated	Uncombinated
Security	Key mechanism	Pins			Furnished less pins, springs, and keys
Basic security Open keyways	Best keyways	6, 7	–	–	80-043 ² (6-pin) 80-033 ² (7-pin)
Enhanced security¹ Restricted use	Check pin	7	R (Everest 29)	80-037	80-036



80-037



80-033

1. Upgraded and high security options for the R and legacy B keyways can be found in the Conventional and FSIC sections using SL cylinders.
2. 80-043 and 80-033 available in 606 and 626 only. Best A, B, C, D, DD, E, F, G, H, J, K, L, M, N, Q, R, TB, and TD keyways only. Suffix "B" to keyway letter, e.g. AB, DB, etc.

SFIC housings for commercial deadlocks, less core

Lockset series	Description	Number	Specify finish
B500 Series	Outside	B610-204	605, 606, 609, 612, 613, 622, 625, 626, and 643e
	Inside	B610-281 ¹	See note below
B600 Series	Outside	B610-204	605, 609, 612, 613, 619, 622, 625, 626, and 643e
	Inside	B610-281	See note below

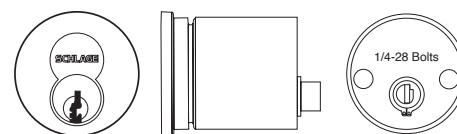

1. Inside housing does not include snap-on faceplate. Specify finish of B610-014 snap-on faceplate ordered separately for inside of B562 and B662.

Note: Tailpieces not included.

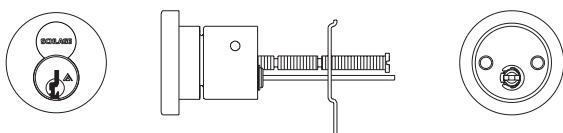

SFIC Exits

Security	Key mechanism	Pins	Patent protected keyway families	Rim cylinders for exit devices	Mortise cylinders for Von Duprin and other straight cam applications
				Core and housing	Cylinder with compression ring, spring and 1/4" blocking ring
Enhanced security¹ Restricted use	Check pin	7	R (Everest 29)	80-329	80-302
Housing less core²				80-129	80-102



K510-730
Straight cam,
other applications

1. Upgraded and high security options for the R and legacy B keyways can be found in the Conventional and FSIC sections using SL cylinders.
- Note: All Von Duprin and straight cam mortise cylinders are 1 3/8" long.

SFIC cylinders for Schlage mortise and other competitive locksets

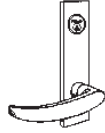

L & N escutcheons (cylinders with compression ring)

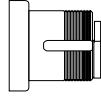

Compression ring and spring



Sectional trim (cylinder with compression ring, spring and 1/4" blocking ring)

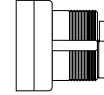

With blocking ring

SFIC Mortise			Patent protected keyway families	L and N Escutcheons (cylinder with compression ring and spring)		Sectional (rose) trim (cylinder with compression ring, spring, and 1/4" blocking ring)	
Security	Key mechanism	Pins		Functions	L Series	L and HL Series	
Enhanced security¹ Restricted use	Check pin	7	R (Everest 29)	All except below	80-308	80-301	
				L9060 outside	80-304	80-304 + 36-082-050 ²	
				LM9280, LM/LMV9380, L/LV9081	26-106	26-106 + 36-082-025 ³	
Housing less core				All except below	80-108	80-101	
				L9060 outside	80-104	80-104 + 36-082-050 ²	
				LM9280, LM/LMV9380, L/LV9081	26-104	26-104 + 36-082-025 ³	

1. Upgraded and high security options for the R and legacy B keyways can be found in the Conventional and FSIC sections using SL cylinders.
 2. L9060 requires a 1/2" blocking ring (part 36-082-050).
 3. L/LV9081, LM9280, LM/LMV9380 require a 1/4" blocking ring (part 36-082-025).
 Note all cylinders are 1 3/8" long.



K583-255
Cam for all functions except L9060 outside



K510-680
Cam for L9060 outside

SFIC for competitive locksets			Patent protected keyway families	Adams Rite MS, 4500 and 4700 Series, Lori 4500 Series, and Corbin Russwin DL3000 Series deadlocks/deadlatches		Adams Rite 4070 deadbolt	
Security	Key mechanism	Pins		Cylinder with 7/16" blocking ring	Housing less core		
Enhanced security Restricted use	Check pin	7	R (Everest 29)	80-303	80-305 ¹		
				Housing less core	80-103	80-105	

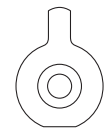

K510-711
Adams Rite MS Cam



B520-378
Adams Rite 4070 cam

Finish options



Bright Brass (605)	Satin Brass (606)	Antique Brass (609)	Satin Bronze (612)	Oil Rubbed Bronze (613)	Satin Nickel (619)	Matte Black (622)	Bright Chrome (625)	Satin Chrome (626)	Aged Bronze (643e)
--------------------	-------------------	---------------------	--------------------	-------------------------	--------------------	-------------------	---------------------	--------------------	--------------------

Housing	Housing and core	Housing	Housing	Housing	Housing	Housing and core	Housing	Housing and core	Housing and core
---------	------------------	---------	---------	---------	---------	------------------	---------	------------------	------------------

Cams

Cams for Schlage mortise cylinders in other manufacturers' mortise locks

Conventional (modular) mortise cylinders made after July 2010, FSIC and SFIC cylinders can be supplied with the cam substituted to fit other manufacturers' mortise locks. Substitutions are made at no additional charge. Only cylinders listed here qualify. Select cam from left half of chart below and order following this example: 20-001 x B520-731 626 S123.

Conventional modular	Standard	Primus	Primus UL 437
Cylinder with compression spring	26-021	20-701	20-501
Cylinder with compression ring and spring	20-001	20-700	20-500
Cylinder with compression ring, spring and 1/8" blocking ring	20-002	-	-
Lockout function - cylinder only	-	20-715	20-515
Full Size Interchangeable Core (FSIC)	Standard	Primus	
Less core - housing only	20-059	-	
Less core - housing with compression ring and spring	26-064	-	
Less core - housing with compression ring, spring and 3/8" blocking ring	26-094	-	
Core with housing, compression ring and spring	26-091	20-763	
Core with housing, compression ring, spring and 3/8" blocking ring	20-061	20-771	
Small Format Interchangeable Core (SFIC)	Standard	Keyed construction	Disposable construction
Less core - housing with compression ring, spring and 1/4" blocking ring	80-102	-	-
Core with housing, compression ring, spring and 1/4" blocking ring	80-302	80-132	80-110

	For conventional (modular) cylinders made after July 2010 and all interchangeable core (FSIC and SFIC) cylinders Cam substitutions allowed only on above listed cylinders			For conventional (non-IC) cylinders manufactured before August 2010 Order separately, not available with cylinder	
	Modular cylinders 1 1/8", 1 3/8", 1 5/8"		FSIC and SFIC 1 1/4", 1 1/2", 1 3/4"	Classic keyways	Everest keyways and Primus
Corbin Russwin® DL4000 Series (Old Corbin 420 and Russwin 1503)	B520-730 Dim. X = .155 Y = .761	B520-731 Dim. X = .155 Y = .761	B520-254 (was XB11-426) Dim. X = .155 Y = .761	B520-295 (was XB11-458) Dim. X = .155 Y = .761	B520-366 (was XB11-656)
Corbin Russwin® ML2200 Series (Old Corbin 7000-9000 and Russwin 4000-5000) All functions except ML2255 and ML2242 inside (see straight cam)	B520-732 Dim. X = .236 Y = .731	B520-733 Dim. X = .236 Y = .731	B520-253 (was XB11-352) Dim. X = .232 Y = .727	B520-233 (was XB08-899) Dim. X = .232 Y = .729	B520-309 (was XB11-629)
Corbin Russwin A65 ML2200 master ring deadbolt functions manufactured before 6/10/93 and old Russwin cast iron residential locks. For all Best 40H Series and 30H Deadbolt function	B520-734 Dim. X = .242 Y = .757	B520-735 Dim. X = .242 Y = .757	B520-360 (was XB11-817) Dim. X = .235 Y = .752	B520-223 (was XB03-142) Dim. X = .235 Y = .729	B520-367 (was XB11-887)
Yale® 2160 Arrow® #004 Sargent® 13-0660 All functions except 16 inside and 50 outside	B520-736 Dim. X = .187 Y = .727	B520-737 Dim. X = .187 Y = .727	B520-296 (was XB11-461, replaces XB11-484) Dim. X = .186 Y = .725	B520-256 (was XB11-430, replaces XB10-659) Dim. X = .189 Y = .718	B520-329 (was XB11-631, replaces XB11-630)
Best 30H Latch functions only	L583-476 Dim. X = .338 Y = .71	L583-477 Dim. X = .338 Y = .71	K510-730 Dim. X = .338 Y = .71	B502-191 Dim. X = .338 Y = .71	B502-948 Dim. X = .338 Y = .71

Note: Other manufacturers' registered trade names are for identification and reference only.

Cams for Schlage SL modular, conventional cylinders in other manufacturer's locks

Cam substitutions only allowed on these cylinder numbers:

Order example:
91-051 X B520-780 626 R123

91-051 118

91-051 114

1 1/8"

1 1/4"

Corbin Russwin® DL4000 Series
(Old Corbin 420 and Russwin 1503)

B520-780

B520-781

Dim. X = .155 Y = .761

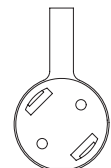
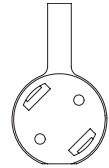

Corbin Russwin ML2200 Series
(Old Corbin 7000-9000 and
Russwin 4000-5000)

B520-782

B520-783

All functions except ML2255 and ML2242
inside (see straight cam)

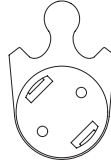

Dim. X = .236 Y = .731

Corbin Russwin A65 ML2200 master ring
deadbolt functions manufactured before
6/10/93 and old Russwin cast iron
residential locks. For all Best 40H Series
and 30H deadbolt functions.

B520-784

B520-785



Dim. X = .242 Y = .757

Yale® 2160
Arrow® #004
Sargent® 13-0660

B520-786

B520-787

All functions except 16 inside and 50 outside



Dim. X = .187 Y = .727

Best 30H Latch only functions
(SFIC cam substitutions allowed on 80-302,
80-110, 80-132, and 80-102 only.)

L583-802

L583-803

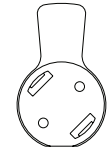
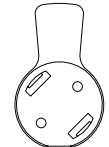

Dim. X = .338 Y = .71

Cams

Cams for other manufacturer's locks to fit aluminum doors

Adams Rite MS 4500 and 4700 Series, Lori 4500 Series and Corbin Russwin DL3000 Series

Current modular
(cylinders made after August 2010)



L583-446
Modular cylinder
lengths 1 1/8",
1 3/8" and 1 5/8"



L583-447
Modular cylinder
lengths 1 1/4",
1 1/2" and 1 3/4"

SL modular cylinders



L583-773
Modular SL cylinder
length 1 1/8"



L583-774
Modular SL cylinder
length 1 1/4"

Schlage L Series (except L9060 outside) cams - non modular
(cylinders made before August 2010)

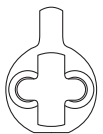

B502-292
Classic keyways

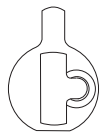

B502-944
Everest and Primus

Adams Rite MS 4070 Series

Current modular
(cylinders made after August 2010)



B520-743
Modular cylinder
lengths 1 1/8",
1 3/8" and 1 5/8"



B520-744
Modular cylinder
lengths 1 1/4",
1 1/2" and 1 3/4"

SL modular cylinders



B520-788
Modular SL cylinder
length 1 1/8"



B520-789
Modular SL cylinder
length 1 1/4"

Von Duprin and Other straight cam applications (Schlage L9060 outside) - non modular
(cylinders made before August 2010)



B502-380
Classic keyways



B502-945
Everest and Primus

Mortise and rim cylinder finish options

Bright Brass (605)	Satin Brass (606)	Antique Brass (609)	Satin Bronze (612)	Oil Rubbed Bronze (613)	Satin Nickel (619)	Matte Black (622)	Bright Chrome (625)	Satin Chrome (626)	Bright Stainless Steel (629)	Satin Stainless Steel (630)	Aged Bronze (643e)
Faceplate	Faceplate and plug	Faceplate	Faceplate	Faceplate	Faceplate	Faceplate and plug	Faceplate	Faceplate and plug	Faceplate	Faceplate	Faceplate and plug

Key blanks

Classic key blanks

Numbers shown are for key blanks. For cut keys, change “35” prefix to “48” for change keys and “49” for master keys. Suffix key section, e.g. 35-101 E. See facing page for available key sections.

Standard

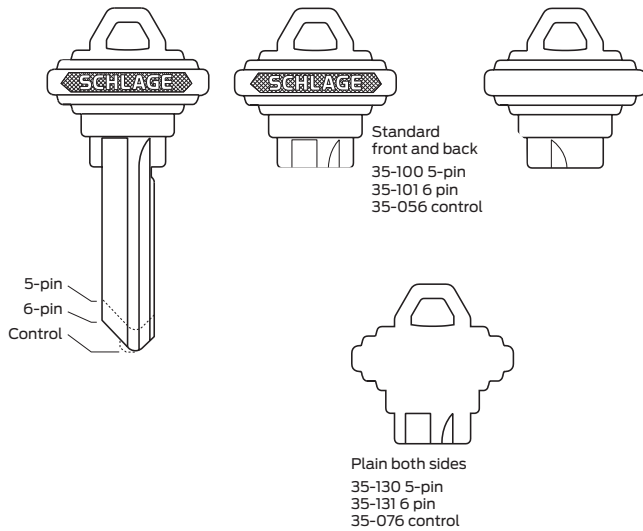

Standard bow

To order conventional key blanks with DO NOT DUPLICATE, specify XQ06-878. Specify plain bow keys for applications when keys must be stamped with additional information such as special die stamps, serial numbering, etc.

Primus

Standard front
35-157-RP operating
35-157-XP operating
35-158-RP control
35-158-XP control

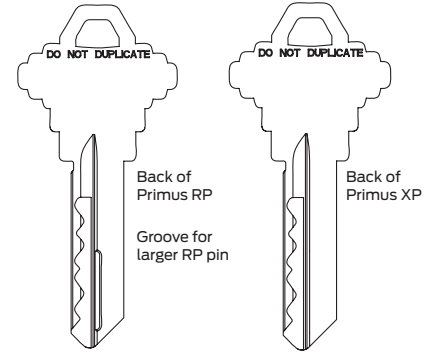
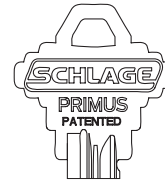

Legacy Primus

Standard front
35-157 operating
35-158 control

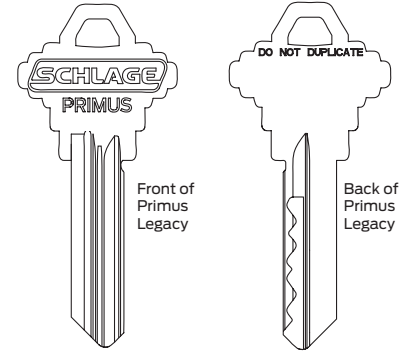

To order standard legacy Primus key blanks with DO NOT DUPLICATE, specify XQ06-878.

Specialty key blanks

Large bow

Ideal for special keys which must be visibly distinctive within a key system, or for very specialized marking.

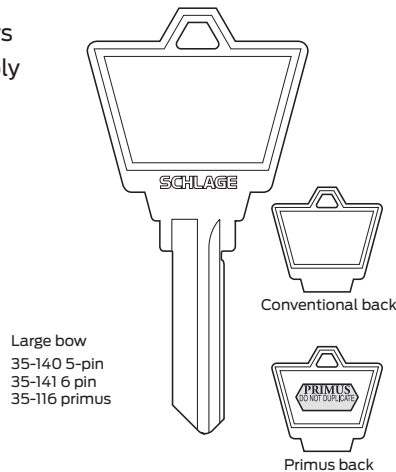

Access bow

Conforms to California Title 24 for handicap access.

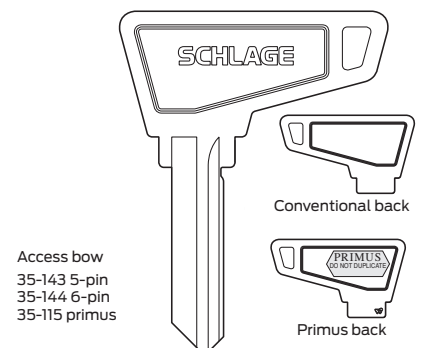

Specify control keys in architectural specifications and on purchase orders.

Key blanks

Everest full size key blanks

Numbers shown are for key blanks. For cut keys, change “35” prefix to “48” for change keys and “49” for master keys. Suffix key section, e.g. 35-013-XP T123.

Standard

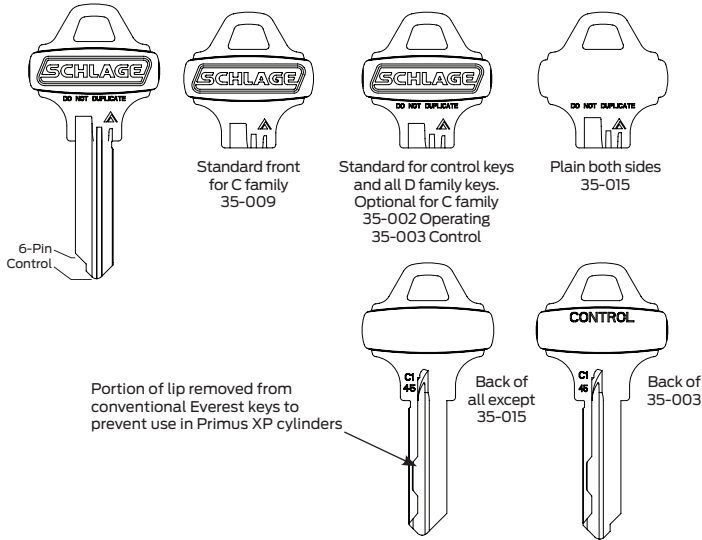

Everest Primus XP

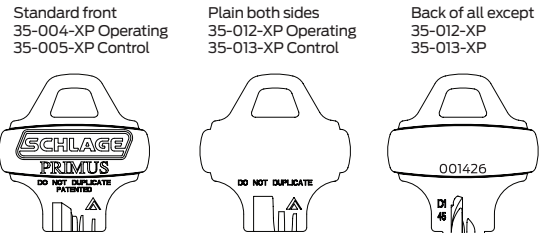

Everest Legacy Primus

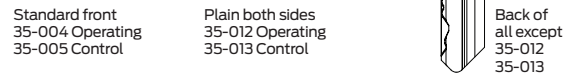

To order, specify quantity, 6-digit ID number, and key section. Key blanks are packed 50 per box, 1000 per case. Specify Control Keys in architectural specifications and on purchase orders.

Everest conventional keys are available with and without DO NOT DUPLICATE. Specify plain bow keys for applications when keys must be stamped with additional information such as special die stamps, serial numbering, etc.

Everest 29 full size key blanks

Numbers shown are for key blanks. For cut keys, change “35” prefix to “48” for change keys and “49” for master keys. Suffix key section, e.g. 35-270 S123. See facing page for available key sections.

Standard

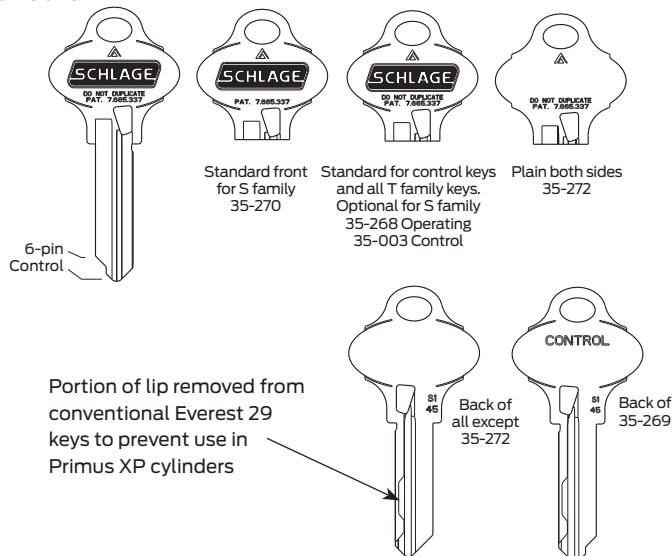

Everest 29 Primus XP

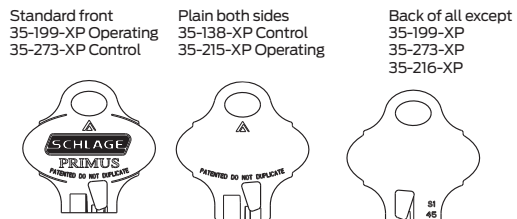

Everest 29 Legacy Primus

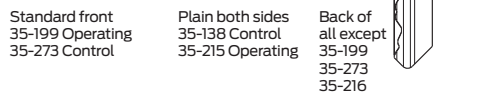

To order, specify quantity, 6-digit ID number, and key section. Key blanks are packed 50 per box, 1000 per case. Specify Control Keys in architectural specifications and on purchase orders.

Everest 29 conventional keys are available with and without DO NOT DUPLICATE. Specify plain bow keys for applications when keys must be stamped with additional information such as special die stamps, serial numbering, etc.

Key blanks

Small format key blanks

For cut keys, change “35” prefix to “48” for change keys and “49” for master keys.
 Suffix key section, e.g. 35-009 R123. All keyways are restricted so they are not published.

Everest B and Everest 29 R family end user restricted keyways are not stocked by locksmiths or other dealers. They are drop shipped directly to the end user and offer restricted protection without geographical exclusivity. All orders for these key blanks require a letter of authorization from the end user. Dedicated SFIC keyways are available to locksmiths and service-oriented contract hardware dealers, this keyway is controlled similar to Primus XP Levels 1+ and 7. See page 19 for details.

Everest B restricted key blanks

Standard and SL

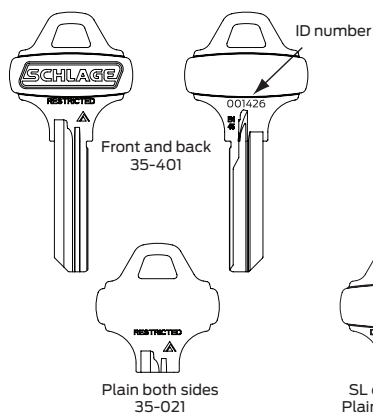

SL Control

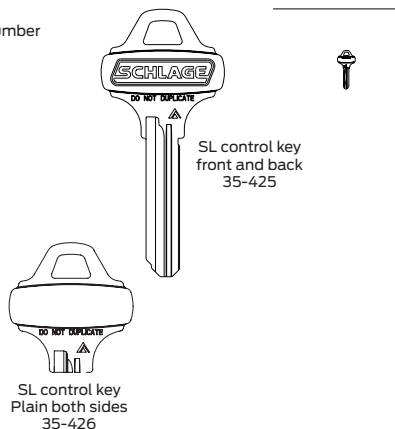

Everest B Primus XP key blanks

Standard and SL

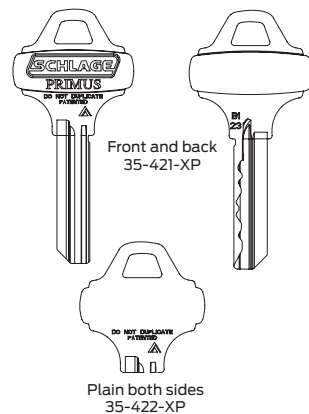

SL Control

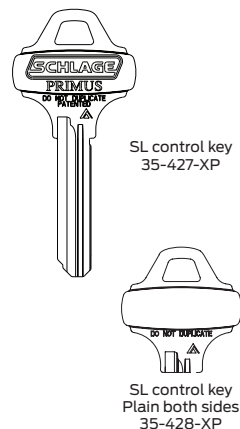

Everest 29 R patented, restricted key blanks

Standard and SL

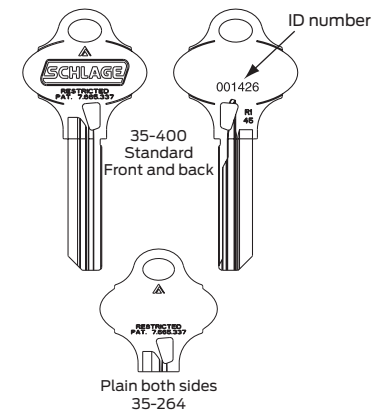

SL Control

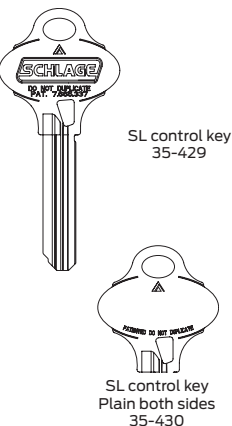

Everest 29 R Primus XP key blanks

Standard and SL

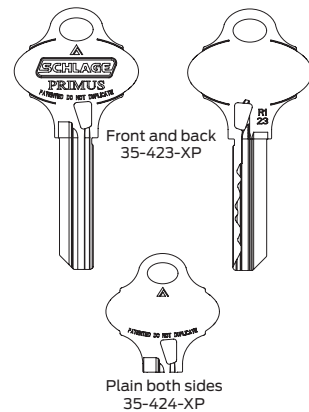

SL Control

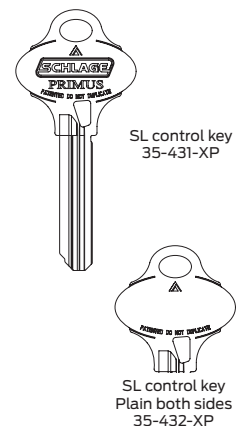

Best® type key blanks

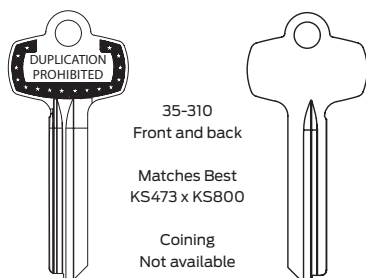

Available in the ten most popular Best key sections. Suffix key section plus “B” to number when ordering, (example 35-310 AB).

Equipment

Cylinder service equipment and tools

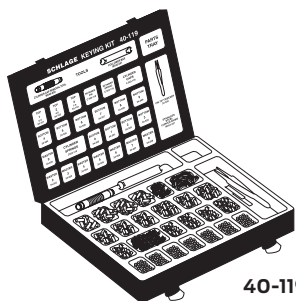

40-119

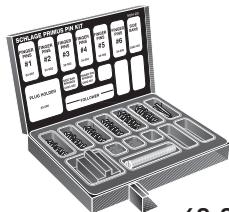

40-070

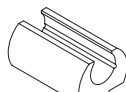

40-066

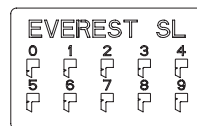

40-245

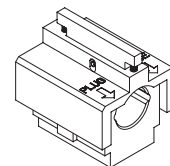

40-296

Pin kits

40-119	For full size conventional cylinders Contains bottom, top and master pins, springs, cap pins, cap pin springs, caps, follower, tweezers, key gauge, shims, cap removal tool.
40-070	Primus finger pin kit Contains finger pins, sidebars, springs and plug holder.
40-129	SFIC wooden pin kit for A2 System Contains all pins and springs, key gauge, tweezers.
40-247	Everest 29 SL A2 pin kit Contains standard (single notch) and master (2 notch) L pins, springs, tweezers, pin gauge and locking sidebars.

To service RP cylinders, the appropriate RP finger pin (parts 34-223 through 34-229) can be placed in open compartment of existing Primus pin kit (40-070).

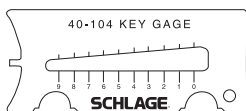

Key gauge

40-104	Full size keys
40-128	A2 System SFIC keys



Modular cylinder service kit

40-223	Full kit with parts and travel box Includes cylinder front housings, back housings, key cams, and cam screws
--------	--

Full size cylinder tools

40-293	Primus plug holder
40-116	Shell loading tool
M204-200	Pin tweezers
M540-056	Cylinder cap removal tool
M504-548	Modular follower bar
40-296	SL and SL Primus XP holder and crimp tool
40-245	SL pin gauge

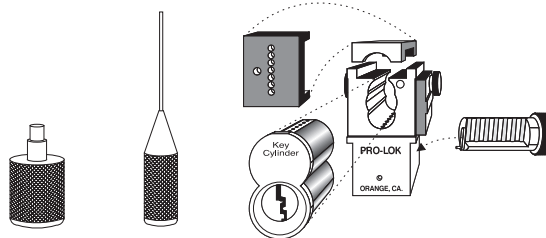

40-173

40-172

40-171

Small format IC tools

(included in 40-129 kit)

40-173	Staking tool
40-172	Ejector tool
40-171	IC decode, rekey, dump tool

Equipment

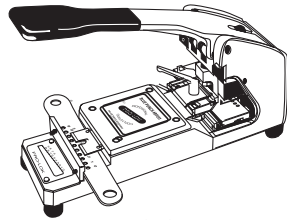

40-075

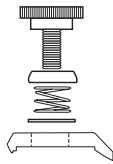

40-074

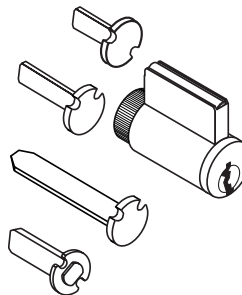

Blue punch key machine

40-071	Everest B Family small format IC keys and Everest 29 R Family small format IC keys only
40-075	Classic Obverse, Everest C, and Everest 29 S Family keys only (Conventional and Primus)
40-099	Key biting punch for Everest D Family and Everest 29 T Family
40-074	Upgrade jaw kit adds Everest C Family and Everest 29 S Family capability Blue Punch machines with serial numbers below 990358, made before July 1999

Multiple tailpiece cylinders

Reduce cylinder inventory by stocking these cylinders packed with tailpieces to fit these locks:

- A Series (all designs)
- AL Series
- D Series knobs
- D Series levers
- H Series knobs (all designs)
- ND Series levers

40-100	Conventional
40-700	Legacy Primus
40-700-XP	Primus XP
40-700-RP	Primus RP
40-500	Legacy Primus UL
40-500-XP	Primus XP UL
40-500-RP	Primus RP UL
91-200	Everest 29 SL
91-700	Primus XP Everest 29 SL

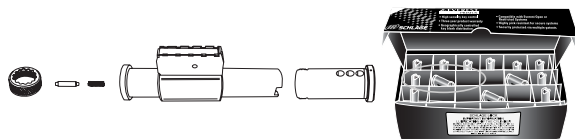

Bulk pack cylinder kit

Bulk packs are 10-packs that contain the components you need to quickly build 10 cylinders. All shells are pre-loaded with top pins and springs.

Key mechanism	Standard pin and tumbler	Check pin	SL	All Primus (except SL)	SL Primus
Keyways	All Classic	Everest C, D Everest 29 S, T	Everest B Everest 29 R	Noted below	Everest B Everest 29 R
Conventional (KIK/KIL)	09-409	09-751	91-451 ¹	09-764 (Everest C, D/Everest 29 S, T) 09-833 (Classic)	91-551 ³
Mortise (specify length)	09-412	09-754	91-452 ²	09-767 (Everest C, D/Everest 29 S, T) 09-835 (Classic)	91-552 ³
Rim	09-410	09-752	91-453 ¹	09-765 (Everest C, D/Everest 29 S, T) 09-834 (Classic)	91-553 ³
FSIC	09-411	09-753	91-454	09-766 (Everest C, D/Everest 29 S, T) 09-836 (Classic)	91-554

Note: Specify keyway and finish. Keys and tailpieces or cams must be ordered separately.

1. Cylinder is shipped unassembled. Does not include L pins, L pin springs or key blanks.
2. Cylinder is shipped unassembled. Does not include cam, collar, L pins, L pin springs or key blanks.
3. Cylinder is shipped unassembled. Does not include L pins, L pin springs, Primus finger pins, Primus finger pin springs or key blanks.

Ordering

Order authorizations

Overtur Keying - Restricted Products

The <https://restrictedproduct.allegion.com> website allows users to easily manage all order authorizations for restricted key systems. It eliminates paperwork by providing a secure communication portal for generating restricted product authorizations.

Overtur Keying allows you to:

- Manage who can generate restricted product authorizations for your key system
- Get validations completed quicker, rather than waiting on them through the mail
- Ability to review order authorization history

Fax or mail in method

An alternate means of providing authorization can be done on company letterhead for end users. The sample below illustrates the information needed when using this method.

Primus XP I.D. cards

Primus XP I.D. cards are used as authorization credentials for Primus XP Level 7 and 8 keys. Cards have a signature panel on the back and are issued by the servicing locksmith or dealer who directly supports the system owner. The owner must present the I.D. card to obtain duplicate keys or additions to his system. The signature will be validated by the dealer.

Primus XP Cards

Level	Number
Levels 7 & 8	40-060-XP



FORMS & EXAMPLES • Sample Letter of Authorization For All Restricted Key Products



DISTRICT 10

End User Letterhead - REQUIRED

District 10 Schools
555 Main Street
End User City, State 55555
(555) 555-5555

May 1, 2003 ← **Date - REQUIRED**

Dealer Name - RECOMMENDED

Facility Name - REQUIRED

To: Schlage Dealer
100 East Avenue
Dealer City, State 11111

Include Registry Number & Facility Code (stamped on keys) for existing key systems

RE: District 10, Jones Elementary School

Master Keyed Products, Construction Keys, Locks Less
Cylinders, and Locks with Construction Cores
Attn: Building Project Manager
District 10 Schools
555 Main Street
End User City, State 55555

Master Keys, Change Keys, Control Keys, and Key Blanks
Attn: Locksmith
District 10 Lockshop
1201 Fifth Avenue
End User City, State 55555

Authorized Ship-To Addresses - REQUIRED

Sincerely,

End User Representative
Facilities Manager

End User Representative Signature - REQUIRED

Letter may be mailed or faxed to Schlage
Schlage Restricted Order Processing
3899 Hancock Expressway
Colorado Springs, CO 80911

Specifications

Standard conventional keying

Everest 29

Everest 29 products are available to commercial customers. When no other keyway is specified on a commercial customer's order, Schlage supplies Everest 29 as an S123 keyway for stock products and as S145 keyway for master keyed products. All Everest 29 conventional cylinders have six standard pins and a check pin. Legacy Everest keyways are available, but must be specified at the time of ordering.

Classic keyway

Classic keyway products are supplied upon request to commercial customers and are the default keyway for residential customers. All residential products are shipped Schlage 'C' as default, 'E' if masterkeyed.

Primus

Primus products are available to qualifying commercial customers. All Primus cylinders (legacy, RP, and XP) have six standard pins and five finger pins.

Keys

Classic keyway cylinders are supplied with two 6-pin keys unless otherwise specified. All Everest 29, Primus RP, and Primus XP pinned cylinders are supplied with two 6-pin keys, except certain stocking levels of Primus cylinders which are supplied less key blanks (LKB) for security reasons.

Keying options

Keying options include master keying and construction keying. Construction master keying is not available for Primus cylinders; however, construction cores can be furnished if the job is interchangeable core.

Warranty

Three-year limited mechanical warranty. All Everest and Everest 29 Primus products feature a limited lifetime key breakage warranty. Portable security products feature a lifetime warranty.

Software

All Schlage cylinders and keys can be used in conjunction with SITEMASTER 200® key control management software for highly effective key control.

Certifications

UL / cUL

20-5XX part numbered Primus cylinders are UL 437 Listed locking cylinders.

Keyway diagrams

The Classic Obverse keyway family

Obverse keyways for classic conventional cylinders

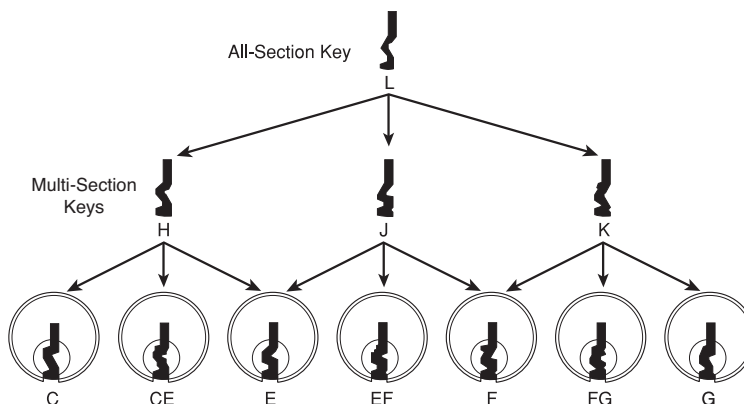

Obverse keyways for Classic Primus RP cylinders levels 1 through 4

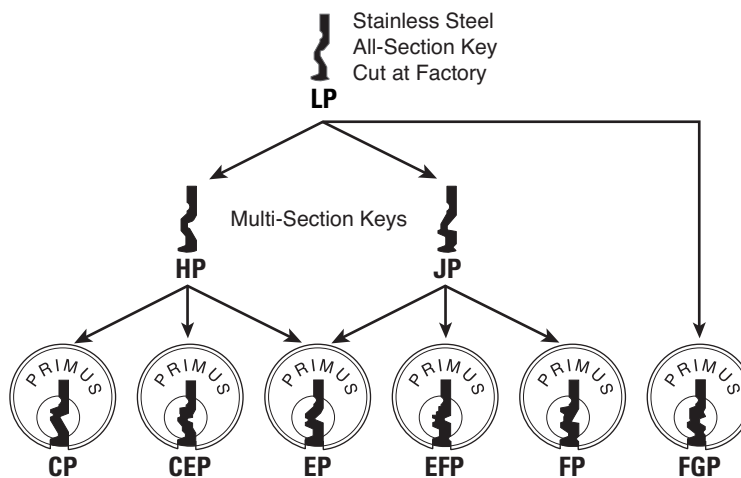

Everest 29 S keyway family

S family keyways for Everest 29 conventional cylinders and Primus XP levels 7, 8, and 9

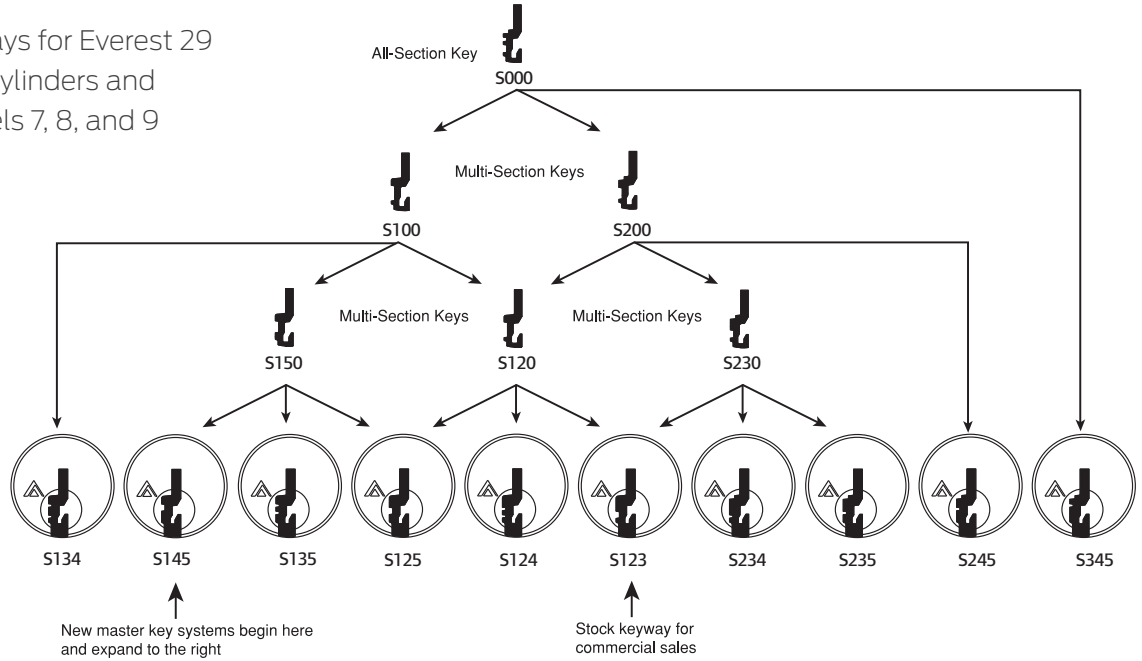

Everest C keyway family

C family keyways for Everest conventional cylinders and Primus XP levels 7, 8, and 9

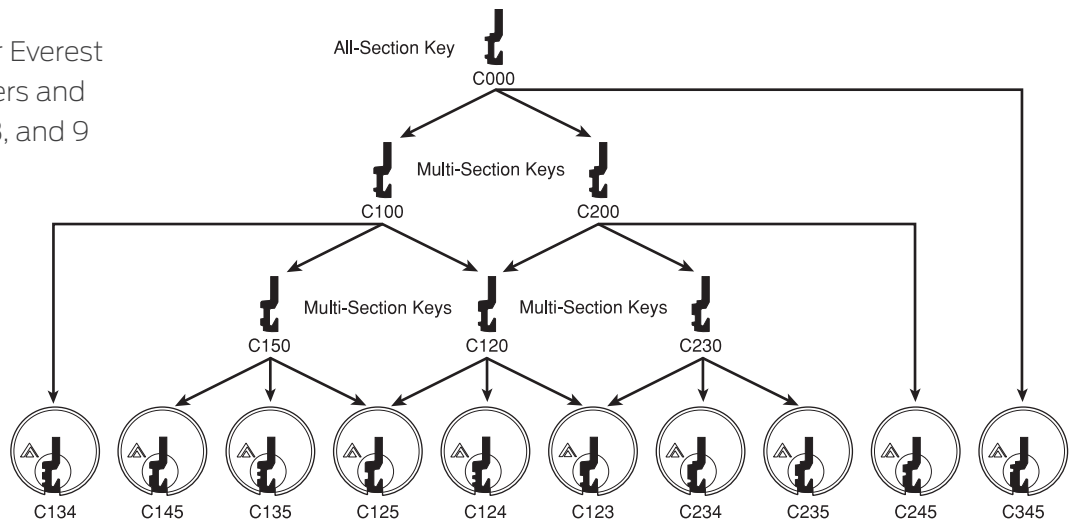

Useful definitions

Bitting - the numbers which represent the cuts of a key; the actual cuts or combination of a key.

Blade - the part of a key that may contain the cuts and the millings.

Body - the part of the cylinder that surrounds the plug, usually containing tumbler chambers corresponding to those in the plug.

Bottom pin - a cylindrical shaped tumbler with a conical point at the end that comes in direct contact with a key.

Bow - the portion of the key that serves as the grip or handle.

Cam - a lock or cylinder component that transfers the rotational motion of a key or cylinder plug to the bolt that works the lock.

Capping block - a fixture used to aid installation of caps on small format interchangeable cores.

Change key - a key that operates one cylinder or a group of keyed alike cylinders in a key system.

Construction cores - temporary cores for use during the construction phase of a building that can later be easily removed and replaced with permanent cores.

Control key - a special key used for the removal and replacement of an interchangeable core.

Ejector pin - a tool used to drive all the elements of a pin chamber out of small format interchangeable cores.

High security cylinder - a cylinder that offers a greater degree of resistance to picking, bumping, impressioning, key duplication, drilling or other forms of forcible entry. The keys also are controlled so only authorized people can make duplicates.

Housing - that part of a locking device designed to enclose the core.

Interchangeable core - a cylinder designed to be removed and/or installed with only a special key called a control key; no tools or removal of the lock required to change the core.

Key blank - an uncut key manufactured to allow its entry into the keyway of a specific cylinder.

Master key - a key that operates all master keyed locks or cylinders in a key system or a part thereof.

Master pin - a cylindrical shaped tumbler, flat or crowned on both ends, used between the bottom and top pins to create additional shear lines.

Pin tumbler - usually a cylindrical shaped tumbler; three types are used: bottom pin, master pin, and top pin.

Plug - the part of the cylinder which contains the keyway, with tumbler chambers usually corresponding to those in the cylinder shell.

Plug follower - a tool used to remove the plug while retaining the top pins and springs, and possibly other components in the shell.

Rim cylinder - a cylinder with a tailpiece to actuate the lock mechanism typically used with surface applied locks and attached to the lock or door with a mounting plate and machine screws.

Shim - a thin piece of curved stainless steel used to unlock the cylinder plug from the body by separating the pin tumblers at the shear line.

Sidebar - the secondary locking device operated with a patented side bit milling design such as found in the Primus XP cylinder mechanism.

Tailpiece - an actuator attached to the rear of a cylinder, parallel to the plug, used on rim, key-in-knob or other special cylinders.

Top pin - a cylindrical shaped tumbler, flat or crowned on both ends, that is installed in direct contact with the tumbler spring.

Tumbler - a movable obstruction of varying length in a cylinder that makes direct contact with a key or another tumbler and prevents an incorrect key from operating the lock or cylinder.

About Allegion

Allegion (NYSE: ALLE) is a global pioneer in seamless access, with leading brands like CISA®, Interflex®, LCN®, Schlage®, SimonsVoss® and Von Duprin®. Focusing on security around the door and adjacent areas, Allegion secures people and assets with a range of solutions for homes, businesses, schools and institutions.

For more, visit www.allegion.com

KRYPTONITE ■ LCN ■  ■ STEELCRAFT ■ VON DUPRIN