

# Cylinders & Components

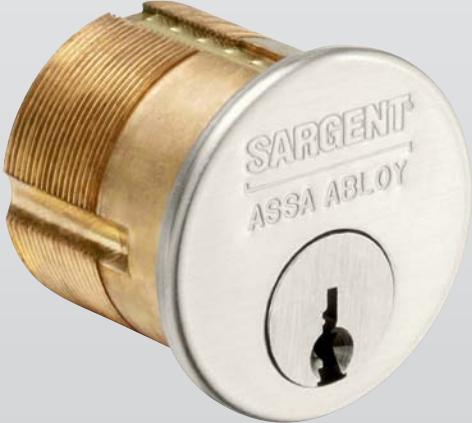
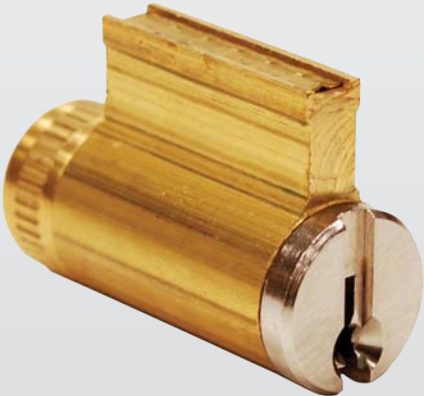

## Cylinders and Components

### Table of Contents

KeyWizard™ Key Management Software . . . . .	3
Cylinders for Bored, Auxiliary, Integra lock and Mail Box locks . . . . .	4
Cylinder Parts: Bored, Auxiliary and Integra locks. . . . .	5
40 Series Mortise Cylinders and 34 Series Rim Cylinders . . . . .	6
Cylinder Parts: Mortise and Rim Cylinders. . . . .	7
Cams for Mortise Cylinder . . . . .	8
Installation Tools for 6300 and 7300 Cylinders . . . . .	9
6300 Large Format Interchangeable (Removable) Cores . . . . .	10
7300B Small Format Interchangeable Cores . . . . .	11
Old Style Removable Cores, Mortise/Rim Cylinders . . . . .	12
Competitive Keyway Cylinders, Bump Resistant Cylinders, Kits and Top Loading Kits . . . . .	13
124 Mortise Turn Lever Cylinders, Rosettes and Blocking Rings. . . . .	14
Construction Master Keying Lost Ball, Split Keying Construction Keying Kit (Lost Ball). . . . .	15
Bitting Dimensions, Pins and Springs . . . . .	16
Conventional, Signature and LFIC (Removable) Core Keying Kits & Depth Key Sets. . . . .	17
Key Blanks/Key Sections, Bitting Lists . . . . .	18
Visual Key Control and Tamper Proof Packaging . . . . .	19
Master Keying and Cylinder Terms . . . . .	20

## SARGENT Cylinder & Key Control Products

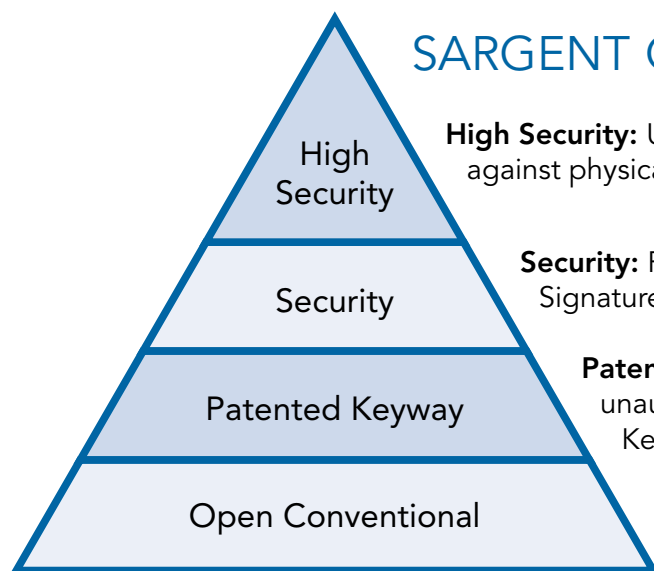

**High Security:** UL437 Drill & Pick-Resistant Systems offer protection against physical attacks. Includes Degree DG3, and UL-Keso.

**Security:** Protection against picking. Includes Degree DG2, Signature, Keso and Keso F1.

**Patented Keyway:** Keys are protected against unauthorized duplication. Includes Degree DG1, XC and Keso F1.

**Open Conventional:** Legacy systems whose patents have run out and are not protected.

Copyright © 2006-2022, Sargent Manufacturing Company, an ASSA ABLOY Group company. All rights reserved. Reproduction in whole or in part without the express written permission of Sargent Manufacturing Company is prohibited.

### On The Cover

#41 Mortise Cylinder

1-800-727-5477 • [www.sargentlock.com](http://www.sargentlock.com)

Experience a safer  
and more open world

# KeyWizard™ Key Management Software

## Cylinders and Components

### **SARGENT'S KeyWizard™ 5.5 Software Package Tracks Multiple Key Systems Including Keys, Keyholders, Locations, and Hardware Information**

This comprehensive key management software package was developed for locksmiths and end-users to track detailed information.

The program features easy to navigate, non-cluttered screens and uses a format similar to Microsoft® Outlook™.



#### Features:

- Free Technical Support at 1-800-610-1706 and system upgrades for 1 year
- Website support at www.keywizard.net
- Multi-level passwords and access levels
- Clear, easy to read screens
- Manages multiple end user key systems
- Customized query, reporting and search capability
- Global searching across multiple key systems
- Comprehensive hardware schedules
- Keyholder photos and signatures for identity verification
- Scheduled maintenance and reminders for overdue keys and back-ups
- Accurate key symbol sorting
- Multi-level key authorizations and key deposits
- Network and stand-alone versions
- Pinning calculators
- Reports options including printing in a variety of formats and e-mail
- Cylinder and key random serial ID generator
- Key authorization forms that can be printed at will
- Editable field titles
- Ability to connect to a website and search for any updates

#### How to order for new users:

Single License Version — KW-SS1  
Network Version — KW-SSN1  
Demonstration Version — KW-DEMO1

#### How to order, if upgrading from KeyMinder\*:

Single License Version — UP-KW-SS1  
Network Version — UP-KW-SSN1

\*consult factory for eligibility requirements

#### Keying Data

Keying data (key sets and bittings) is available for order with new or existing systems to eliminate the need for manual data entry into Key Wizard. Place order based on size of system.

Part Number	Description
DLKW1	1 to 50 bittings
DLKW2	51 to 200 bittings
DLKW3	201 to 1000 bittings
DLKW4	1001-3000 bittings
DLKW5	3001-6000 bittings
DLKW6	6001-9000 bittings
DLKW7	Over 9000 bittings

#### Computer System Recommendations:

##### REQUIRED:

- 350 MHz processor
- 60 MB hard disk space
- Windows® 7, Vista, XP, NT, ME, 2000 or 98
- 64MB Ram
- CD drive

##### RECOMMENDED For Better Performance:

- 500 MHz or faster
- 70 MB or more
- Windows® 7, Vista, XP, NT, ME, 2000 or 98
- 64MB Ram
- CD drive

#### BITTING LISTS

Paper bitting lists provided at no charge for factory corresponding keyed orders when requested at time of hardware order. An owners letter of authorization must be attached to all purchase orders. Existing key system bittings lists are also available contact key records for more information.

# Cylinders for Bored, Auxiliary, Integra Lock and Mail Box Locks

**SARGENT**  
**ASSA ABLOY**

## Cylinders and Components

### 10, 7, 6500 & 7500 (Lever) Line Standard Cylinders



Part Numbers:  
C10-1 for all functions (except 50)  
C10-2 for Hotel 50 function

### 10X Line Cylinder



Part Numbers:  
C10X-1 for all functions (except 50)  
C10X-2 for Hotel 50 function

### 8 and 9 Line Cylinders\* (Knob Locks)



Part Numbers:  
C8-1 for all functions (except 50)  
C8-2 for Hotel 50 function

### 11 Line Cylinder



Part Numbers:  
C11-1 for all functions (except 50)  
C11-2 for Hotel 50 function

### 6 Line Cylinder

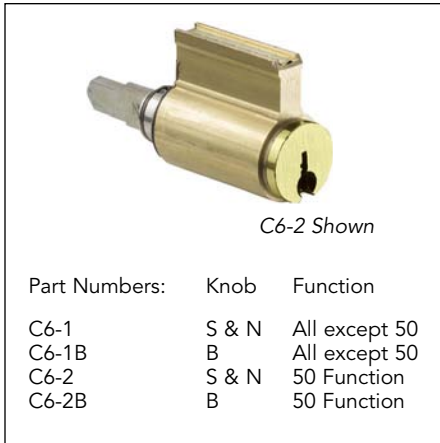

Part Numbers:	Knob	Function
C6-1	S & N	All except 50
C6-1B	B	All except 50
C6-2	S & N	50 Function
C6-2B	B	50 Function

### 4101 Mailbox Cylinder



Consult mailbox manufacturer to determine compatibility of cylinder and mailbox. 5 or 6 pin systems

- 2 cut day keys provided
- US Postal regulations prohibit master keyed cylinder

### 460, 470 and 480 Deadbolt & 7500 Interconnected Deadbolt Cylinders

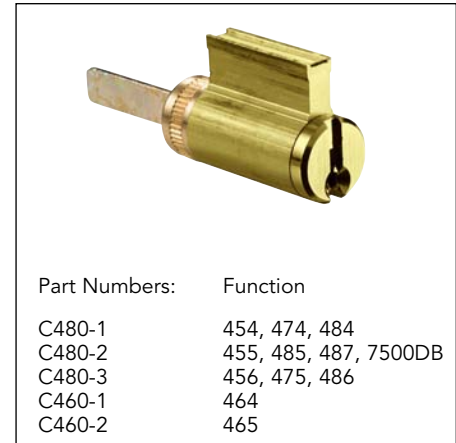

Part Numbers:	Function
C480-1	454, 474, 484
C480-2	455, 485, 487, 7500DB
C480-3	456, 475, 486
C460-1	464
C460-2	465

### 7600\* Integralock Cylinder



Part Number:  
C7600-1 for all functions (except 26, 27, 50)



### 5\*, 8X and 5500 Line Cylinders



Part Numbers:  
C5500-1 for all functions (except 5 line 50)  
C5500-2 5 line 50 function hotel  
C8X-1

### 758/858 Padlock Cylinder



Part Numbers:  
C750-1 for 758/858 Padlocks  
04 Finish only

### 1655 Locker Lock Cylinder



Part Numbers:  
C1655-1  
13-1813 (tail piece)

\* Discontinued products but cylinders still offered.

All cylinders are 6 Pin and are supplied with 2 nickel silver keys offered in the keyways listed on Page 18 unless noted otherwise.

When cylinders are ordered keyed to 5 pin systems, the (6th) last chamber will be empty.

Cylinder finishes: 4, 15, BSP.

For cylinders in competitive keyways, see Page 13.

When double cylinder locksets are keyed alike on both sides, 2 change keys are supplied

Cylinders supplied as 1 bitted unless otherwise specified random or master keyed. For master keyed orders provide keying details as requested on SARGENT Keyed Order Lead Sheets, located in the price book or contact customer service.

Cylinders ordered from SARGENT Turbo program are supplied as 1 bitted as standard unless otherwise specified.

Cylinders BHMA A156.5 Grade 1 listed except hotel functions, C5500 and C7600.

Copyright © 2006-2022, Sargent Manufacturing Company, an ASSA ABLOY Group company. All rights reserved. Reproduction in whole or in part without the express written permission of Sargent Manufacturing Company is prohibited.

90622 08/22

# Cylinder Parts: Bored, Auxiliary and Integra Locks

## Cylinders and Components

### Hotel Function Not Shown

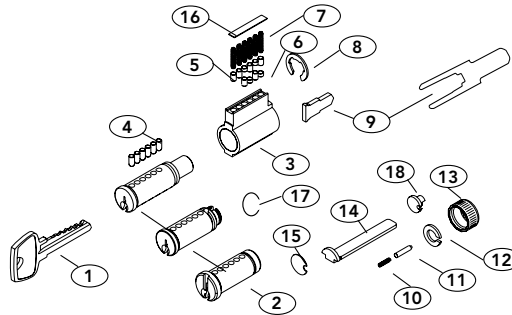

Item	Description	Lock Line	Part Number	Comment
1	6 Pin Key Blank		See Table Page 18	
2	Plug	7600	13-0090	New 7600 Only
	Plug	470, 480, 1655, 7500	13-0874	
	Plug	460	13-0904	
	Plug	5500*, 8X	13-0920	
	Plug & Pin Assembly	7, 8, 9* Knobs	13-3425	
	Plug & Ring Assembly	6, 7 Lever, 8L*, 10, 10X, 11, 6500, 7500, 758, 858	13-3142	
3	Shell Only	7600	13-1139	7600 (No Slide) Illustration Shows Slide Disassembled
	Cylinder Shell & Slide Assembly Without Pins & Springs	7, 8L*, 10, 10X, 11 Levers, 758, 858	13-3257	
		7, 8*, 9* Knobs	13-2048	
		6, 6500	13-3257 – Effective 9/03	
		460, 470, 480, 1655	13-3493	
		5500*, 8X	13-3514	
4	Bottom Pin	All Cylinders	See Table Page 16	
5	Top Pin	All Cylinders	13-0059	Pin No. 10 (Length .200)
6	Master Pin	All Cylinders	See Table Page 16	
7	Compression Spring	All Cylinders	13-0265	
8	Plug Retainer	5*	01-0870	
	Plug Retainer Ring	7, 8*, 9 Knob Plug manufactured prior to March 2005	06-0166	
	Plug Retainer Ring	6, 7 Lever, 8L*, 10, 10X, 11, 6500 and 8 line* knob manufactured after April 2005	13-0205	
	Plug Retainer Ring	5500, 8X	01-0870	
9	60-70 Tail Piece	60-70 6500	05-0033	6 Pin Only
	70 Tail Piece	70-6500	05-0034	7 Pin Only
	60 Tail Piece	60-7, 10	10-0239	Except 54 Function
	70 Tail Piece	70-7, 10	10-0239	6 Pin Except 54 Function
	70 Tail Piece	70-7, 10	10-0240	7 Pin Except 54 Function
	70 Tail Piece	70-7, 10	10-0286	6 Pin 54 Function
	70 Tail Piece	70-7, 10	10-0287	7 Pin 54 Function
	60 Tail Piece	60-11	11-0171	All Functions
	Tail Piece	11	13-1385	Except 50 Function
	Tail Piece	10X	10-3629	
	Tail Piece	7, 8L*, 10, 6500	13-0895	
	Tail Piece	6 (S & N Knobs)	13-0907	05, 24, 37, 38-2, 44
	Tail Piece	6 (B Knob)	13-0908	
	Tail Piece	5500	13-0919	
10	Cylinder Cap Spring	460, 470, 480, 1655	13-1555 – Effective 6/03	
			13-0693 – Prior to 6/03	
11	Cylinder Cap Pin	460, 470, 480, 1655	13-1554 – Effective 6/03	
			13-0691 – Prior to 6/03	
12	Cylinder Tail Washer	464, 474, 484	13-0882	
			464, 465, 485, 486, 487, 1655	13-0883
13	Cylinder Endcap	460, 470, 485, 1655 series	13-0875	
			464, 474, 484	13-0878
			465, 485, 487	13-0880
14	Tail Piece	475, 486	13-0881	1-3/4" to 2" (44mm to 51mm) Door Thickness
			460, 470, 480, 1655	
15	Blocking Piece	460, 470, 480, 1655	13-0779	
			7 Old*, 7, 8*, 8L*, 9, 10, 11, 6500	13-0816
16	Slide (Mfg prior June 2008)	7600	13-0816	
		7, 8*, 8X, 9*, 10, 10X, 11, 1655, 6500	13-1341**	
17	Tail Piece Retainer	6, 7, 10, 10X, 11, 6500	13-0680	
18	Cam Connector	1655	13-1813	

\* Discontinued Product  
\*\* See page 13 for Details

# 40 Series Mortise Cylinders and 34 Series Rim Cylinders

## Cylinders and Components



### 40 Series Mortise Cylinder

- Cylinder: Solid brass, 1-5/32" (29mm) diameter
- Cap: Brass, bronze or stainless steel
- Furnished standard with No. 97 rosette and compression spring
- Optional Collars/Spacers available and ordered separately, refer to product catalogs for additional information
- See Cam Chart on Page 8 for cam required
- 6 pin standard; for 7 pin specify "7 pin", size 42 minimum
- No. 41 cylinder not available in 7 pin
- Mortise cylinder assemblies that are ordered without hardware are supplied with standard SARGENT offset cam 13-0664
- Cylinder finishes: 3, 4, 9, 10, 10B, 10BE, 10BL, 14, 15, 20D, 32, 32D, BSP, and WSP
- Plug finishes: 4, 15, BSP

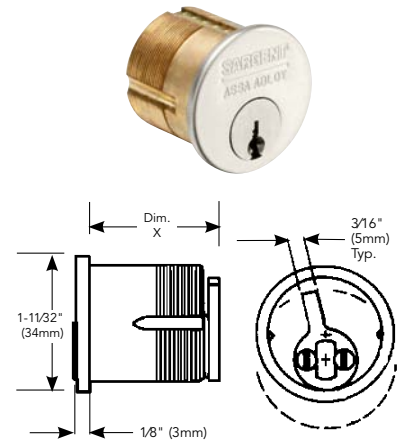

		Length under cylinder head									
Cylinder No.		41	42	43	44	46	48	50	52	54	56
Dim. X		1-1/8" (29mm)	1-1/4" (32mm)	1-3/8" (35mm)	1-1/2" (38mm)	1-3/4" (44mm)	2" (51mm)	2-1/4" (57mm)	2-1/2" (64mm)	2-3/4" (70mm)	3" (76mm)

### 50-40 Series Hotel Type Cylinder

Features same as standard 40 Series cylinders except:

- For use with 7850, 8250, and 9250 only.
- For 6 pin systems only. Note: emergency key is 7 pin.
- Contact factory for compatibility requirements for existing 6 pin systems
- Uses only cam #115 (13-2045)
- Guest and Master keys will only retract the latch bolt but not project or retract the dead bolt
- Emergency keys (catalog # 7268 EMK) retract the latchbolt and deadbolt and can also project the deadbolt
- C Series keyways supplied standard, specify if different keyway is required. On 1 bitted or KD, CA key way will be supplied if not otherwise specified
- Consult Sargent Key records dept. when adding Hotel cylinders to existing key systems for compatibility
- Length under cylinder head (Dim. X)  
50-43 1-3/8" (35mm); 50-44 1-1/2" (38mm)

### 78-40 Series Exposed Shell Only Cylinders

- Cylinder: Solid brass, 1-5/32" (29mm) diameter
- 6 pin standard, for 7 pin specify "7 pin"
- For use with SARGENT mortise locks with Escutcheon Trim (KE 3/4, LE 3/4) only
- See Function Table on Page 8 for cam required
- 78-41 6 pin; single cylinder function only except 50
- 78-42 6 or 7 pin; single cylinder functions only
- 78-43 6 or 7 pin; all functions except 50
- Plug finishes: 4, 15, BSP



### 34 Series Rim Type Cylinder

- 27/32" (21mm) screw pattern for through-bolted SARGENT exit devices
- Cylinder: Solid brass
- Cap: Brass, bronze or stainless steel
- Furnished standard with No. 97 rosette and compression spring, "break-off" screws and back plate
- 6 pin standard, for 7 pin specify "7 pin"
- Horizontal tail piece only
- Cylinder finishes: 3, 4, 9, 10, 10 B, 10 BE, 10 BL, 14, 15, 20D, 32, 32D, BSP, and WSP
- Plug finishes: 4, 15, BSP



No. of Pins	Door Thickness when used without outside trim	Dim. A (Min.)
6	2-3/8" to 3-1/4" (60mm to 82mm)	1-1/16" (27mm)
7	2-1/2" to 3-1/2" (64mm to 89mm)	1-7/32" (31mm)

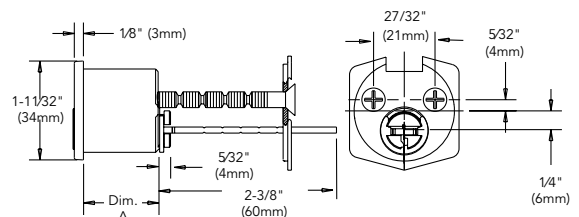

All cylinders are 6 Pin and are supplied with 2 nickel silver change keys offered in the keyways listed on Page 18 unless noted otherwise. In cylinders ordered for 5 pin systems the (6th) last chamber will be empty.

When double cylinder locksets are keyed alike on both sides, 2 change keys are supplied.

For cylinders in competitive keyways, see Page 13.

Cylinders supplied as 1 bitted unless otherwise specified random or master keyed. For master keyed orders provide keying details as requested on SARGENT Keyed Order Lead Sheets, located in the price book or contact customer service.

Cylinders BHMA A156.5 Grade 1 listed except hotel functions.

Copyright © 2006-2022, Sargent Manufacturing Company, an ASSA ABLOY Group company. All rights reserved. Reproduction in whole or in part without the express written permission of Sargent Manufacturing Company is prohibited.

90622 08/22



1-800-727-5477 • www.sargentlock.com

Experience a safer and more open world

# Cylinder Parts: Mortise and Rim Cylinders

## Cylinders and Components

### 34 Rim/40 Series Mortise Cylinder Parts

Item	Description	Part Number	Where Used	Comment
1	Plug	See Table Below	40 Mortise & 34 Rim	
2	Cylinder Shell, Cap & Slide Assy.	See Table Below	40 Mortise & 34 Rim	Illustration Shows Slide Disassembled
3	Bottom Pin	See Table Page 15	40 Mortise & 34 Rim	
4	Master Pin	13-0062	40 Mortise & 34 Rim	Pin No. 10 (Length .260)
5	Top Pin	See Table Page 15	40 Mortise & 34 Rim	
6	Compression Spring	13-0265	40 Mortise & 34 Rim	
7	Cam	See Table Page 8	40 Mortise	
8	Screw	01-1121	40 Mortise	#3-48 x 5/16" (8mm) PH. FL.
9	Plug Retainer	13-0080	34 Rim	
10	Tail Piece	13-0085	34 Rim	
11	Cylinder Back Plate	13-0086	34 Rim	
12	Connecting Screws Standard Connecting Screws	13-0075 13-0074	34 Rim 34 Rim	#12-24 x 2-5/8" (67mm) #12-24 x 2-1/8" (54mm)
13	6 Pin Slide 7 Pin Slide	13-0779 13-0780	40 Mortise & 34 Rim 40 Mortise & 34 Rim	Mfg prior to 06-2008* Mfg prior to 06-2008*
13	6 Pin Slide 7 Pin Slide	13-1341 13-1797 v	40 Mortise & 34 Rim 40 Mortise & 34 Rim	Mfg after 06-2008* Mfg after 06-2008*

\* See page 12 for Details

#### Standard Cylinders (Hotel Function Not Shown)

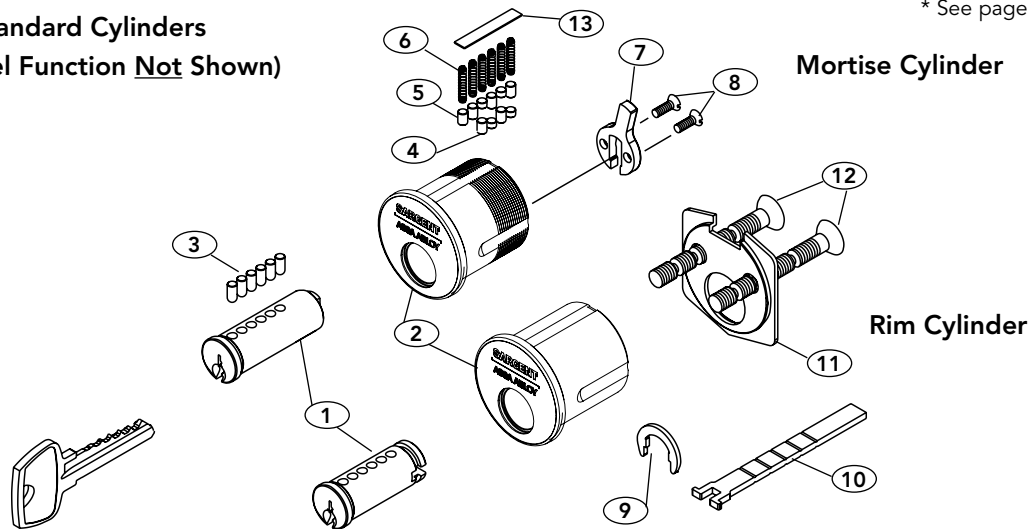





No.	Cylinder Length	6 Pin Plug Part Number	7 Pin Plug Part Number	6 Pin Shell & Slide Assy. Part Number	7 Pin Shell & Slide Assy. Part Number
34	—	13-0090	13-0587	13-2005	13-2712
41	1-1/8" (29mm)	13-0401	N/A	13-2005	N/A
42	1-1/4" (32mm)	13-0402	13-0402	13-2006	13-2765
43	1-3/8" (35mm)	13-0403	13-0403	13-2766	13-2766
44	1-1/2" (38mm)	13-0404	13-0404	13-2767	13-2767
46	1-3/4" (44mm)	13-0405	13-0405	13-2768	13-2768
48	2" (51mm)	13-0406	13-0406	13-2769	13-2769
50	2-1/4" (57mm)	13-0407	13-0407	13-2770	13-2770
52	2-1/2" (64mm)	13-0408	13-0408	13-2771	13-2771
54	2-3/4" (70mm)	13-0409	13-0409	13-2772	13-2772
56	3" (76mm)	13-0474	13-0474	13-2773	13-2773



# Cams for Mortise Cylinder

## Cylinders and Components

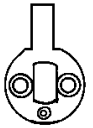
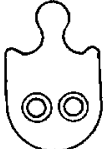
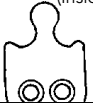
### Cams For Conventional Mortise Cylinders\* in SARGENT Keyways





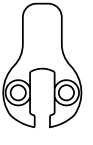

 <b>Standard Cam</b> (13-0664)  Standard open slotted cam provided on all 40 Series - standard. Except: 16, 50 & 92 function Mortise Locks	 <b>#105</b> (13-0665)  Short cam used for 78/8200 (16 & 92) function locks (Inside Cylinder) (Was -3 & -8)	 <b>22-Standard</b> (13-0662)  Cam used for Construction Key Systems (22-), except for 16 & 92 function inside cylinder & 50 function mortise locks	 <b>22-105</b> (13-0663)  Cam used for Construction Key Systems (22-), 16 & 92 function mortise locks (Inside Cylinders)	 <b>#115</b> (13-2045)  Cam used for Hotel (7850/8250) function cylinders only (formally -2)
				

### Miscellaneous Cams\*

 <b>#101</b> (13-0512) Adams Rite 1850, 4700	 <b>#113</b> (13-0921) SARGENT 4370 Series key switches	 <b>#106</b> (13-0938) "Open" Schlage "L"	 <b>#112</b> (13-0097) "Open" Misc.
--	--	--	--

\* Two screws attach cam to cylinder, order as an 01-1121, when needed

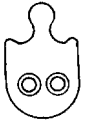
### Cams for 6300 Large Format Interchangeable (Removable) Core Mortise Cylinders (Factory assembled to housing)

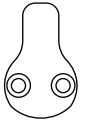
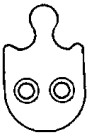
 <b>Standard</b> 6300 Series Cam	 <b>-105</b> Cam for inside of 8216/8292 functions	 <b>-115</b> Cam for Supplied standard with 50-63-43 Hotel 50 function cylinders/locks	 <b>-101</b> ADAMS RITE 1850 4710	 <b>-106</b> Schlage "L" 	 <b>-112</b> Wide Straight	 <b>-113</b> 4370 Series key switch
--	--	--	--	---	--	---

- 6300 Cams are factory installed and are not removable
- 6300 Cams are not sold separately
- Specify required Cam as a suffix 63-42-101 cam
- For Standard Cam: No Suffix is required



# Installation Tools for 6300 and 7300 Cylinders

## Cylinders and Components

**432 RC**  
**6300 Large Format**  
**Interchangeable (Removable)**  
**Core Installation Tool**



**432 IC**  
**7300 Small Format**  
**Interchangeable Core**  
**Installation Tool**



- The 432 RC and 432 IC are tools to assist in installing SARGENT Large Format Interchangeable (Removable) Core and Small Format Interchangeable Core Mortise Housings. These tools make it easy to thread a cylinder body into a Mortise lock and can also help check the cylinder function in a lock before installing the cylinder core
- Order: 432 RC for the SARGENT Large Format Interchangeable (Removable) Core Installation Tool
- Order: 432 IC for the Small Format Interchangeable Core Install Tool

# 6300 Series Large Format Interchangeable (Removable) Cores

## Cylinders and Components

**SARGENT**  
**ASSA ABLOY**

### 60- Prefix Disposable Plastic Core



- During the construction phase in non restricted areas, disposable plastic cores can be used, eliminating use and distribution of the actual keys
- Once construction is near completion, the permanent keyed cores will be installed and the building secured; permanent keyed cores are ordered separately as 6300 Cores
- Disposable cores are available for Mortise, Exits and most cylindrical lock sets
- Operate with coin or flat screw driver
- One piece design allows for easy installation
- To order separately: Use p/n 13-5177
- Mortise Sizes available: 60-42, 60-43, 60-44 & 60-46
- Available 6300 Mortise Cams on Pg 6
- Specify required Cam as a suffix: 60-44-105 cam
- For Standard Cam: No Suffix is required

### 64- Prefix Construction Keyed Large Format Interchangeable (Removable) Core Keyed Cylinders

- The SARGENT 6400 interchangeable brass construction core enables doors to be locked during project construction period
- Using 6400 cores prevents keys for the permanent key system from becoming available during the construction process
- After construction is completed, the 6400 brass cores are removed and replaced with 6300 keyed-permanent interchangeable Cores
- A special control key releases the locking sleeve of the cylinder core allowing immediate removal of the core
- Construction cores are all keyed alike in one KA keyset
- Furnished with 6 keys and 1 control key per order
- Plug face dimpled for easy identification
- Order as a 64- prefix with products
- Mortise Sizes available: 64-42, 64-43, 64-44 and 64-46
- Available 6300 Mortise Cams on Page 8
- Specify required Cam as a suffix: 64-44-105 cam
- For Standard Cam: No Suffix is required
- For keyed temp core sold separately use catalog # 6400
- For Construction Control Key use catalog # 6251 CTL
- For Construction Master Key use catalog # 6251 CMK

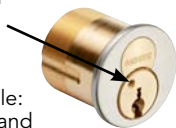

### 6300 Permanent Large Format Interchangeable (Removable) Cores Cylinders

- SARGENT LFIC (Removable) Core Cylinders and Master Key Systems are available for a quick change of cylinders for increased security. It is not necessary to remove the lock from a door to rekey the opening
- Special "control" key is used to release a locking cam allowing immediate removal of the core
- Available for use in many SARGENT products (Exit Devices, Mortise locks, Bored locks and padlocks)
- LFIC Key Systems can also include conventional cylinders operated by the same Master/change keys when the 6300 quick change feature is not needed
- Can be master or grand-master keyed
- 2 Change keys provided
- 6 pin standard
- 1 bitted available for field keying
- 1 bitted cylinders supplied with 2 key blanks, pins and springs in chambers in 3 and 4 only
- Order 1 bitted core control key p/n 6255 CTL to be ordered separately
- HA keyway will be supplied unless otherwise specified
- Wide variety of master key systems available
- Permanent (keyed Large Format Interchangeable) cores supplied with hardware unless specified otherwise
- Available in the following SARGENT keyway families: A, B, C, G, H, K, L, N, R, and V
- Also available in the following single key sections: CR and S
- Control key is 6272 CTL, ordered separately
- Finishes: 4, 15, BSP
- Ordering as a: 6300 LFIC Core x finish and give all keying information



### 65-6300 Unassembled Core Only

- Unassembled core for field rekeying. Includes Control Sleeve and two key blanks
- Springs and pins to be ordered separately (see Pages 16 & 17)
- 65- Prefix - Uncombine Cores
- Finishes: 4, 15, BSP
- HA key way will be supplied standard, unless otherwise specified
- Order as: 65-6300 x finish x keyway (6 pin only)

### 6300 Series Parts Only

- 13-0795 Plug, Finishes: 4, 15, BSP
  - 13-3424 Inner Shell & Slide Assy, Finishes: 4, 15, BSP
  - 13-0796 Control Sleeve
  - 01-0660 Plug retaining ring
  - 13-0797 Slide for Cylinders with a box around the word SARGENT (Mfg prior to 4/06)
  - 13-1341 Slide for Cylinders WITHOUT a box around the word SARGENT (Mfg after 3/06)
- For pins, springs & keying kits see Pages 16 & 17

### 63-34 Rim Cylinder

- Housing: Solid brass
- Cap: Brass, bronze or stainless steel
- Furnished standard with No. 97 rosette and compression ring
- Includes the same tailpiece and screw hole pattern as the #34 cylinder
- Finishes: 3, 4, 9, 15, 10, 10B, 10BE, 10BL, 20D, 32, 32D, BSP
- Order as: 63-34 x Finish
- Also available: 60-34 & 64-34 Rim Cylinders

### 63-40 Series Mortise Cylinders Standard & Hotel Function Cylinders



- Cylinder: Solid brass 1-5/32" diameter
- Cap: Brass, bronze and stainless steel
- Furnished standard with No. 97 rosette and compression ring
- Optional Collars/Spacers available and ordered separately, refer to product catalogs for additional information
- HA Standard Keyway (Except Hotel)
- For use in Sargent 78/8250s hotel function only, "C" series keyway supplied standard, unless otherwise specified. Offered in 50- 63-43 size only (1-3/8") with 115 cam only
- Hotel emergency key is 7269 EMK, ordered separately
- Order hotel cylinders as 50-63-43 or 50-60-43 which will include the 115 cam as standard
- Other SARGENT keyways available
- Mortise Sizes available: 63-42, 63-43, 63-44 & 63-46
- Available 6300 Mortise Cams on Pg 6
- Specify required Cam as a suffix: 63-42 x 32D x 101 cam
- For Standard Cam: No Suffix is required
- Finishes: 3, 4, 9, 15, 10, 10B, 10BE, 10BL, 20D, 32, 32D, BSP
- Order as: 63-42 x Finish
- 60-42 same as above, but supplied with plastic disposable plastic core

### 63-40 Series Mortise Cylinder Sizes

Cylinder #	63-42	63-43	63-44	63-46
Length	1-1/4" (32mm)	1-3/8" (35mm)	1-1/2" (38mm)	1-3/4" (44mm)

### 436-1 Slide Block Kit

- Includes fixture and staking tool for use only with the (10)- 6300 Series Cylinders manufactured after March 2006 for the ease of top loading in the field
- The kit includes 100 each slides p/n 13-1341, Staking Block and staking tool

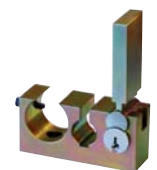
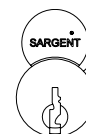

# 7300B Small Format Interchangeable Cores

## Cylinders and Components

### 73- & 73-7P Series Small Format Interchangeable Core Cylinders 6 & 7 Pin

- SARGENT Interchangeable Core Cylinders and Master Key Systems are available for a quick change of cylinders for increased security. It is not necessary to remove the lock from the door to rekey the opening
  - SARGENT 7300B Interchangeable Cores are available in SARGENT 4A and 4B keyways as well as the following standard competitor keyways: A, B, C, D, E, F, G, H, J, K, L, M. SARGENT will extend any key system after receipt of an existing bitting list from the end user
  - New key systems are available in either 4A or 4B keyways. 4A in a 2 step system will be supplied standard on new systems
  - A2 or A4 systems available
- For hardware to be supplied with keyed cores use 73- prefix for 6 pin cores and 73-7P for 7 pin permanent cores provided

### 7300B Keyed Interchangeable Core

- Supplied keyed with two nickel silver change keys as standard
- Face includes SARGENT logo
- If Control keys are required order as 6282BCTL for 6 pin systems or 7282BCTL for 7 pin systems
  - 6 pin system master keys are ordered as 6282BMK
  - 7 pin system master keys are ordered as 7282BMK
- Finishes: 4, 15
- Order separately as:
  - 7300B x Finish (for 6 pin)
  - 7P-7300B x Finish (for 7 pin)

### 65-7300B Uncombined Interchangeable Cores

- Cores for field keying
- No pins, springs or key blanks provided
- No logo on face
- 65- Prefix — uncombined Cores
- Finishes: 4, 15
- Order as:
  - 65-7300B x Finish (for 6 pin)
  - 65-7P-7300B x Finish (for 7 pin)



65-7300B Shown

### 70- Prefix Disposable Plastic Construction Core For SFIC

- Used for doors that do not require key locking during the construction period
- Operate with coin or flat screw driver
- Mortise and rim cylinders accepts either 6 or 7 pin permanent cores. Cylindrical lock sets ships with plastic core and 6 pin tail piece installed while the 7 pin tail piece is packed loose with the lock set
- One piece design allows for easy installation
- Only available with standard cams
- To order separately use p/n 13-5176



### 72- Prefix Brass Interchangeable Construction Core

- SARGENT 7200 Interchangeable 6 pin brass construction core (order 72-prefix with your SARGENT products) enables doors to be locked during the project construction period. Hardware prepared to accept 6 or 7 pin cores installed at job completion
- Using 7200 cores prevents keys for the permanent key system from becoming available during the construction process
- After construction is completed, the 7200 brass cores are removed and replaced with 7300 keyed-permanent interchangeable cores. Mortise and rim cylinders accept either 6 or 7 pin permanent cores. Key in lever locks ship with 6 pin tail installed and 7 pin tail piece shipped loose for use with 7 pin cores
- Plug face is blue for easy identification
- A special Construction Control key 6254 B CTL releases the locking sleeve of the construction core and allows for immediate removal of the core
- Construction cores are 6 pin and keyed alike construction master 6282 B CMK
- Six (6) change keys and one (1) Control key are included per order
- Cores shipped with hardware
- Only available with standard cams
- For keyed temp core sold separately use catalog # 7200

### Key Blanks/Cut Master Type Keys (Nickel Silver)

- 6 pin key blank — order as 6285B x keyway
- 7 pin key blank — order as 7285 B x keyway
- Packed 50 per box
- SARGENT Keyways: 4A, Restricted 4B Competitors: A, B, C, D, E, F, G, H, J, K, L, M
- Cut 6 pin master key, order as cat #6282BMK
- Cut 7 pin master key, order as cat. # 7282BMK
- Cut 6 pin control key order as cat. # 6282BCTL
- Cut 7 pin control key order as cat. # 7282BCTL

### 73-34 Rim Cylinder

- Brass cylinder and housing
- Furnished with No. 97 rosette, break off screws and back plate
- Optional Collars/Spacers available and ordered separately, refer to product catalogs for additional information
- Housing accepts 6 or 7 pin core
- Mounting holes located to match SARGENT hardware
- Finishes: 3, 4, 26, 26D



### 73-43 or 73-46 Series Mortise Cylinders

- Two cylinder sizes
- #43, 1-3/8" (35mm) length under cylinder head including cam
  - 73-43 (6 pin)
  - 73-7P-43 (7 pin),
  - 70-43 housing less core
- #46, 1-3/4" (44mm) length under cylinder head including cam
  - 73-46 (6 pin), 73-7P-46 (7 pin)
  - 70-46 housing less core
- 1-5/32" (29mm) diameter housing
- Furnished with No. 97 cylinder rosette as standard
- Optional Collars/Spacers available and ordered separately, refer to product catalogs for additional information
- Cam is permanently staked to housing
- Housing accepts 6 or 7 pin cores
- Only available with SARGENT off set cam
- Hotel Function not available
- Finishes: 3, 4, 9, 10, 10BE, 10BL, 20D, 26, 26D, BSP



# Old Style Removable Cores Mortise/Rim Cylinders

## Cylinders and Components



### 51- Prefix Old Style Removable Core Cylinder

- SARGENT Removable Core Cylinders and Master Key Systems are available for a quick change of cylinders for increased security. It is not necessary to remove the lock from the door to rekey the opening
  - Special "control" key is used to release a locking cam to allow immediate removal of the core
  - Available for use only in SARGENT products, such as exit devices or mortise locks, which use rim or mortise cylinders
  - SARGENT Offset Cams only
  - Available for existing systems only
  - Can be master or grandmaster keyed
- Note:** If ordering for existing construction key system, provide all keying information.
- Consult factory for existing system compatibility
  - Plug finishes: 4, 15
  - Finishes: 3, 4, 9, 10, 10B, 10BE, 20D, 32, 32D, BSP



### 52- Prefix Old Core Style Construction Removable

- A separate order for permanent cores, with keysets keying information, door and item numbers, should accompany the lockset order. The permanent cores will be shipped directly to the distributor and not to the job site.
- All locks ordered with removable construction core cylinders will be invoiced at the regular price established for 51- prefix
- A separate invoice will be issued to cover the permanent cores at prices listed for removable cores
- Plastic disposable cores not available
- For Construction Control Key use catalog # 6252 CTL
- For Construction Master Key use catalog # 6252 CMK

### Removable Core Cylinders

#### Mortise Type

Series	No. Pins	Length under cylinder head including cam			
		1-1/4" (32mm)	1-3/8" (35mm)	1-1/2" (38mm)	1-3/4" (44mm)
140 Cylinder	7	142	143	144	146
Core Only	7	5142	5143	5144	5146

#### Rim Type

Series	No. Pins	Maximum overall length
134	7	3-3/4" (95mm)

Furnished standard with No. 97 rosette, "break off" screws and back plate.

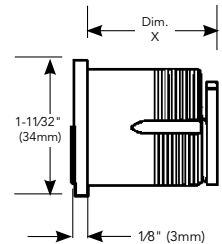

#### Rim Type "Core Only"

	No. Pins
5134	7

Note: These cylinders use the last chamber for the control sleeve. Standard keys contain a cut in this position to engage the control function.

To order mortise housing, order as:

- 13-2052 x finish (1-1/4")
- 13-2053 x finish (1-3/8")
- 13-2054 x finish (1-1/2")
- 13-2055 x finish (1-3/4")

Note dimensions are are with core/cam installed.

Note: Cams are attached to the core and not ordered with housings.

For rim housing only order as 13-2057 x finish.

Back plate 13-0086 and screws 13-0074 are to be ordered separately.

### How to Order

**Mortise** Add 52- prefix to removable core cylinder number (Example: 52-142)  
Not available for functions 50 and 52

**Rim Type** Add 52- prefix to removable core cylinder number (Example: 52-134)

To order removable cores only for mortise and rim type cylinders, add 52- prefix to core designation (Example: 52-5142 or 52-5134)

# Competitive Keyway Cylinders, Bump Resistant Cylinders, Kits and Top Loading Kits

## Cylinders and Components

### Conventional Mortise and Rim Cylinders

SARGENT offers 6-pin cylinders in other manufacturers' keyways. They can be ordered as a prefix for hardware or ordered separately by part numbers. The following product lines are available with SC- and SE- prefixes:

- #41 Mortise Cylinder applications only
  - 7800/8200 Mortise Locks
  - KP8200 Keypad Operated Product
  - 4870 Deadlock
  - 20, 30, 80 and 90 Series Exit Devices
- #34 Rim Cylinder applications
  - KP8877 Keypad Operated Products
  - 8877 Profile Series Access Control Products
  - 20, 30, 80 and 90 Series Exit Devices
- All cylinders 0 bitted and supplied with two brass key blanks as standard. Hotel function not available
- Mortise and rim cylinders supplied without SARGENT logo on face of cylinder and with No. 97 rosette when ordered without hardware
- Optional Collars/Spacers available and ordered separately, refer to product catalogs for additional information
- Mortise cylinders only supplied with SARGENT offset cam similar to 13-0664. Rim cylinders only with SARGENT mounting screw locations. Separate parts not available for these cylinders
- Master keyed cylinders not available
- All mortise cylinders 1-1/8" (29mm) long with standard 1-5/32" shell diameter
- Finishes: 3, 4, 10, 10B, 10BE, 32, 32D, BSP

Cylinder Type	Keyway	
	Schlage "C"	Schlage "E"
Mortise #41	SC-41	SE-41
Rim #34	SC- 34	SE-34

#### How to Order

Part number x SC or SE #34 or 41 x Schlage keyway type  
Example: SC-41 x Finish

### Conventional Bored/Cylindrical Lock Cylinders

The following cylinders can be ordered in competitor's keyways.

- All cylinders 0 bitted and supplied with two brass key blanks as standard. Hotel function not available.
- Cylinders include tail pieces
- Finishes: 4, 15, BSP

Lock Line	Keyway	
	Schlage "C"	Schlage "E"
7, 10, T-Zone (11) & 6500	SC-C10-1	SE-C10-1
470/480 Deadlock	SC-C480-1	SE-480-1

#### How to Order

Part number x SC or SE x finish Schlage keyway type  
Example: SC-C10-1 x 15

### SARGENT Bump Resistant Cylinders

These cylinders employ specially engineered patented components designed to resist bumping while maintaining the cylinder's strength.

#### Bump resistant cylinders offer these features:

- Added line of defense against intruders
- Prevents unauthorized entry

The bump resistant feature is available for the following conventional cylinders (6 and 7 pin only):

- Mortise Cylinders:  
Conventional and XC (11-)
- Rim Cylinders:  
Conventional and XC (11-)
- Bored Cylinders:  
Conventional and XC (11-)



BR is marked on the cylinder slide to identify Bump Resistant Cylinders

Specify bump resistance by adding BR Prefix.

Not available with 63- or 73- cylinder options

How to order example: BR-10G04 LL 26D

### 437BR Bump Resistant Re-Pinning Kit

The 437BR Kit is used to convert existing cylinders into bump resistant cylinders. Simply replace the drivers and springs in all chambers. Each kit includes 300 pins for use in mortise/rim cylinders, 300 pins for use in KIK/ KIL cylinders and 600 springs.



### 436-1 Top Loading Tool Kit

Top loading feature for conventional cylinders and LFIC simplifies the repinning process. The dovetail cut at the top of the cylinder body allows the slide to be "peeled" off easily, without removing the barrel from the cylinder. These conventional cylinders can be easily identified with the "figure eight" marking on the back of the cylinder body (Shown).

436-1 Kit is used for top loading of Large Format Interchangeable (Removable) Cores or Conventional Cylinders

#### This Kit includes the following components:

- Staking Block
- Staking Tool
- 100 Slides (6 Pin)

Addition Slides Available:  
7 Pin slides (Part#13-1797)  
6 Pin slides (Part#13-1341)  
ordered separately

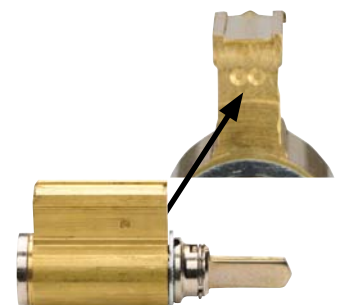
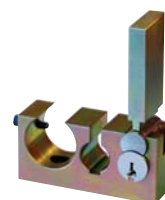
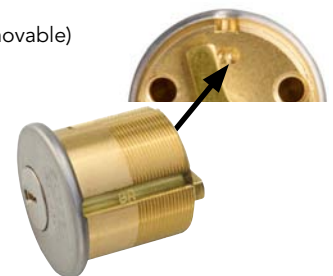

# 124 Mortise Turn Lever Cylinders Rosettes and Blocking Rings

## Cylinders and Components

**SARGENT**  
**ASSA ABLOY**

### 124 Series Turn Lever

- Used in mortise locks in lieu of cylinders when keyed cylinders are not required
- Furnished standard with No. 97 cylinder rosette when ordered separately
- Optional Collars/Spacers available and ordered separately, refer to product catalogs for additional information
- Cylinder: Brass
- Turn lever: Brass or bronze
- Cap: Brass, bronze, stainless steel
- Finishes:  
4, 10B, 10BE, 32D, BSP



No.	124-41	124-42	124-43	124-44	124-46
<b>Length Including Cam (Dim. x)</b>	1-1/8" (29mm)	1-1/4" (32mm)	1-3/8" (35mm)	1-1/2" (38mm)	1-3/4" (44mm)

#### Cam No. Suffix Description

None	Sizes 41, 42, 43, 44 & 46 for standard offset SARGENT cam
-101	Sizes 41, 42, 43, 44 & 46 x cam for Adams Rite 1850 lock
-105	Sizes 41, 42, 43, 44 & 46 x cam for inside of 16 and 92 mortise lock
-106	Sizes 41, 42, 43, 44 & 46 x cam for Open Schlage L
-112	Sizes 41, 42, 43, 44 & 46 x cam for Open Misc.
-113	Sizes 41, 42, 43, 44 & 46 x cam for 4370 Series Keyswitches

### 1KA Rosette with 8200 sectional trim

- Used with mortise cylinders
- Furnished standard with the E, E2, E3 and E4 roses
- Brass, bronze or stainless steel
- 1-1/2" (38mm) Square, includes compression spring
- Projection from door:  
1KA-1 5/16" (8mm) — Standard  
1KA-2 7/16" (11mm)  
1KA-3 9/16" (14mm)  
1KA-4 11/16" (16mm)
- Finishes: 3, 4, 10, 10B, 10BE, 10BL, 20D, 26, 26D, 32, 32D, BSP, WSP



### 1KB Rosette



- Used with 8200 Series mortise locks when cylinders project from door
- Free spinning to protect cylinder from vandalism
- Consult 8200 series catalog for Rosette application details
- Furnished standard with 8200 LN and L rose design mortise trim
- Cast brass, bronze or stainless steel
- 1-1/2" (38mm) diameter, includes compression spring
- Projection from door:  
1KB-1 5/16" (8mm)  
1KB-2 7/16" (11mm)  
1KB-3 9/16" (14mm)  
1KB-4 11/16" (16mm)
- Finishes: 3, 4, 10, 10B, 10BE, 10BL, 20D, 26, 26D, 32, 32D, BSP

### 1SB Cylinder Collar

- Standard for 7800 BHD, 8200 BHL & BHW mortise locks
- Stainless steel
- 1-29/32" diameter
- Projection from door:

1SB-1	5/16" (8mm)
1SB-2	7/16" (11mm)
1SB-3	9/16" (14mm)
1SB-4	11/16" (16mm)

- Finishes: 32, 32D

**Note:** Hardware ordered less cylinder will be provided with the standard collar and/or blocking rings for the standard 1-1/8" mortise cylinders

When using cylinders that are longer consult individual catalogs to order proper size collars and/or spacers.



### 1KB-5 Cylinder Retaining Cap

- Required for double cylinder functions on KS and LS Escutcheon *only*
- Steel or stainless steel
- 1-15/32" (37mm) diameter
- 9/16" (14mm) projection
- Finishes: 3, 4, 9, 10, 10B, 10BE, 10BL, 20D, 26, 26D, 32, 32D, BSP, WSP



### Cylinder Nut Wrench

- This wrench simplifies the installation and removal of mortise cylinder nuts used on 700 Series Auxiliary Control (80 Series ET Trim).
- Part number 97-0568



### 97 Rosette

- Standard for cylinders ordered separately from hardware
- Standard for 4800 dead bolts and 7900 and 7800 series mortise locks
- Brass, bronze or stainless steel
- 1-11/16" diameter (43mm), 9/32" (7mm) projection, includes compression spring
- Finishes: 3, 4, 10, 10B, 10BE, 10BL, 20D, 32, 32D, BSP



### 90 Blocking Ring

- Used with 1KB rosettes as spacer when mortise cylinder projects from face of door
- Brass, bronze or stainless steel
- Finishes: 3, 4, 10, 10B, 10BE, 10BL, 20D, 26, 26D, 32, 32D, BSP, WSP



# Construction Master Keying Lost Ball, Split Key Construction Keying Kit (Lost Ball)

## Cylinders and Components

### 21- Prefix Lost Ball Construction Keying

Cylinders ordered in SARGENT keyways with construction keying will include the 21- prefix Lost Ball feature as standard. This replaces the 22- split key, only available as additions to existing 22- mastered keyed systems. The 21- is not available with old or new style removable/interchangeable core (5100 & 6300s). If construction keying is required for removable/interchangeable cores, use 52- or 64- construction keyed cores.

With the lost ball option, construction keying is obtained easily without going back to each cylinder and removing the construction split key when the building gets turned over.

With this feature, the 21- cylinder is master keyed with small ball bearings in one of the chambers. The plug is drilled in two places along both sides of the same

chamber containing the balls. This allows the construction master key to be used, while leaving these balls in the chamber above the plug when the key is rotated. When it is time to void the construction key, by simply using the change (day) key these balls will fall into the holes in the plug. The construction master key will now no longer operate the lock.

Field construction (21- lost ball) keying can also be easily accomplished with the # 439 LOST BALL REKEYING KIT. The kit includes a drilling block, knurled pin, 500 balls and drill with collar.

Orders with 21- will have all change keys shipped separately from hardware. New key systems provided with six construction master keys unless otherwise specified.

Additions to orders to existing systems are not provided with construction masters unless ordered separately.

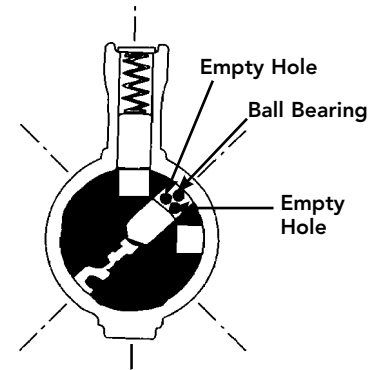

Cutaway cylinder showing construction master key being used. The ball bearings lie flat with one positioned behind the other. They are not stacked.

### To Void Construction Key

**Note:** Ball bearings shown are for illustration purposes only. They do not stack, they align next to each other and lay flat.

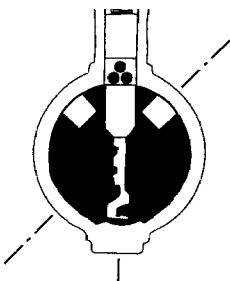

Change key inserted in cylinder

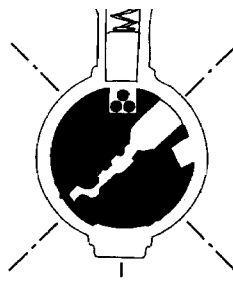

As change key rotates, construction balls fall into hole in the side of plug

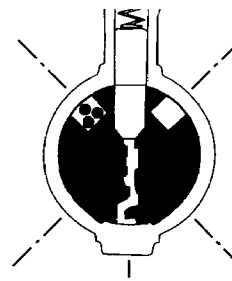

Change key rotated to position for extraction

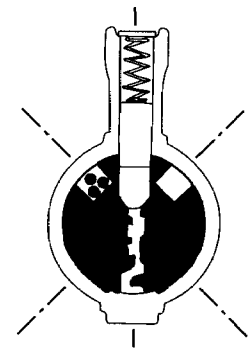

Construction key inserted after balls are trapped. Driver now extends into plug chamber. Construction key will not rotate

### 22- Prefix Split Key Construction Keying

The 22- prefix for split-key construction keying is available only for **existing systems**. When construction is completed, each cylinder must have the construction split key removed with extractor tool part number 14-0070 (one supplied per order). Orders with 22- prefix will have all change keys shipped separately from hardware. Not available with XC or Signature cylinders, non-SARGENT keyways or with cylinders used in other manufacturers' locks. Construction Master Keys part number 6250 CMK must be ordered separately.

### 439 Construction Keying Kit (Lost Ball)

This kit is designed to allow field construction master keying of SARGENT conventional, Signature and XC cylinders.

Each kit includes:

1. Drilling block
2. Drill bit
3. Knurled pin
4. Hex key (not shown)
5. Collar & Set screw Assy.
6. 500 each balls, P/N 13-1103 (not shown)

Drill block shown with plug being prepared for field construction keying

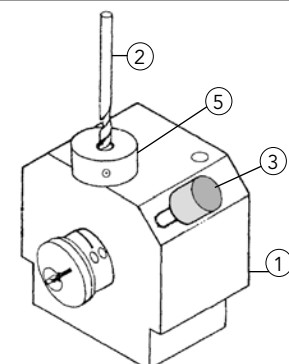

# Bitting Dimensions, Pins and Springs

## Cylinders and Components

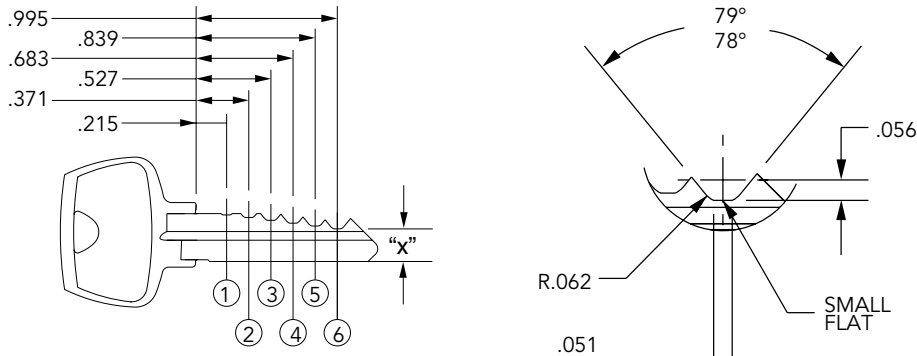

6 PIN POSITIONS Shown, depth and spacing are the same for 5 & 7 pin

Depth tolerance  
± .002", spacing  
tolerance ± .001"

Cut#	1	2	3	4	5	6	7	8	9	10
X	.330	.310	.290	.270	.250	.230	.210	.190	.170	.150

Above bitting dimensions are for SARGENT cylinders in the following keyway families: A, B, C, G, H, K, L, N, R, V

Note: Maximum Adjacent Cut Specification (MACS) = 7

### Springs

13-0265 or 13-1769 used in all cylinders except 3rd & 4th position of 6300 and 10-6300 cores.  
13-0487 used in 3rd & 4th position of 6300, 10-6300 and 11-6300 cores with hollow drivers.

### Brass Pins for SARGENT Keyways

Bottom Pins		Length	Master/Driver Pins		Length
SIZE #1	13-0064	.170	SIZE #2	13-0051	.040
SIZE #2	13-0065	.190	SIZE #3	13-0052	.060
SIZE #3	13-0066	.210	SIZE #4	13-0053	.080
SIZE #4	13-0067	.230	SIZE #5	13-0054	.100
SIZE #5	13-0068	.250	SIZE #6	13-0055	.120
SIZE #6	13-0069	.270	SIZE #7	13-0056	.140
SIZE #7	13-0070	.290	SIZE #8	13-0057	.160
SIZE #8	13-0071	.310	SIZE #9	13-0058	.180
SIZE #9	13-0072	.330	SIZE #10	13-0059	.200
SIZE #10	13-0073	.350	SIZE #11	13-0060	.220
			SIZE #12	13-0061	.240
			SIZE #13	13-0062	.260
			SIZE #14	13-0063	.280

All pins .115 diameter

### 10-34 & 10-40 Signature Pins

Hardened stainless steel bottom pins used only in the 1st chamber of 10-UL 40 Series mortise cylinders & 10-UL 34 Series rim cylinders.

SIZE #1	13-1210	SIZE #6	13-1215
SIZE #2	13-1211	SIZE #7	13-1216
SIZE #3	13-1212	SIZE #8	13-1217
SIZE #4	13-1213	SIZE #9	13-1218
SIZE #5	13-1214		

Stainless spool driver 13-1223 used in all position 10-UL 40 Series and 10-UL 34 Series cylinders.

### 6300, 10-6300 & 11-6300 Large Format Interchangeable (Removable) Core Hollow Top Pins

Different top pins are used only in the 3rd and 4th positions of 6300, 10-6300 and 11-6300 of factory keyed LFIC (Removable) Cores.  
All other chambers use standard top pins.

SIZE #3	13-1229	SIZE #8	13-1238
SIZE #4	13-1234	SIZE #9	13-1239
SIZE #5	13-1235	SIZE #10	13-1240
SIZE #6	13-1236	SIZE #11	13-1761
SIZE #7	13-1237		

Springs used with these Hollow drivers are 13-0487

### Pins Supplied with Keying Kits

Size #	437C/437S		437RC
	Bottom Pins	Master/Driver Pins	Hollow Top Pins used in chambers 3 and 4 of 6300s with spring 13-0487
1	13-0064		
2	13-0065	13-0051	
3	13-0066	13-0052	13-1229
4	13-0067	13-0053	13-1234
5	13-0068	13-0054	13-1235
6	13-0069	13-0055	13-1236
7	13-0070	13-0056	13-1237
8	13-0071	13-0057	13-1238
9	13-0072	13-0058	13-1239
10	13-0073	13-0059	13-1240
11		13-0060	13-1761
12		13-0061	
13		13-0062	
14		13-0063	



# Conventional, Signature and LFIC (Removable) Core Keying Kits and Depth Key Sets

## Cylinders and Components

### 437C Conventional Keying Kit

Includes the brass pins, springs and tools needed to rekey SARGENT conventional, XC cylinders (Except SFIC) and interchangeable cores master keyed after January 2009. This heavy duty steel kit prevents pins from mixing. The kit includes 100 each of top springs 13-0265, 100 each 13-1769 springs used with standard drivers in the (10-) 6300 cores and 100 each of bottom and master/driver pins used in the following multi-family keyways: LA, RA, HA, CA, AA, BA, GA, KA, NA and VA.

**Note:** When re-pinning SARGENT 6300 Large Format Interchangeable (Removable) Core cylinders use hollow drivers and springs in chambers 3 and 4 found in the 437 RC supplemental pinning kit.

Tools included with 437C kit are:

- Tweezers
- Bitting Gauge 435
- Loading Thimble ("Plug Holder" LT2)
- Loading Rod for 6, 8, 10, 11, mortise & rim cylinders, 13-1034
- Loading Rod for 480, 470, 460 and 6300 Cores, 13-1035
- Loading Rod Blades 13-1138 and 13-1037
- See Table on Page 15 for pins included

When pins are sold separately, they are packaged in easy to see and use foil & plastic packages in quantities of 100 per size.

### 437S Signature Keying Kit

Used to service SARGENT Signature cylinders. Includes all of the same components as the 437C plus:

- 100 Blocking Bar Springs, 13-0986
- 10 each Blocking Bars, 13-1109
- 1 each Field Service Tool, 13-3916

**Note:** When repinning 10-6300 Signature Large Format Interchangeable (Removable) Core cylinders made before January 2009 they contained special hollow drivers, the 437RC supplemental pinning kit is required

### 437 RC Large Format Interchangeable (Removable) Core Keying Kit

Use with the 437C or 437S kit. Includes additional pins to repin SARGENT 6300 and 10-6300 Large Format Interchangeable (Removable) Core cylinders that have been pinned using the hollow drivers.

The kit includes special hollow top driver pins and springs which were used in the 3rd and 4th chambers of master keyed cores prior to January 2009.

These pins are in the same increments as standard pins.

Each kit includes:

- 100 each hollow top pin springs, 13-0487
- 50 each cylinder retainers, 01-0660
- 50 each (hollow top pins). See Table on Page 16

### 437BR Bump Resistant Re-Pinning Kit

The 437BR Kit to convert existing cylinders to bump resistant cylinders. Order as a 437BR Kit (See page 13 for additional information)

### Depth Key Sets

Used for manual code key cutting. Each set includes 10 each SARGENT unwarded 6 pin keys. Each different key is cut with all the same bittings from 0 through 9. Order as "Depthkeys".

### Cylinder Spray Lubricant

3.0 oz aerosol pin number 18-0070

Cylinder Spray Cleaner/Deicer 3.0 OZ aerosol pin number 18-0435



437C shown



# Key Blanks/Key Sections, Bitting Lists

## Cylinders and Components



5 Pin		6 Pin		7 Pin					
Key Blank	Key Section	Key Blank	Key Section	Key Blank	Key Section				
265	U R	6265	U	7270	LD				
		6275	R		LH				
270	LD LH LM LDH LDM LHM LN RD RH RM RDH RDM RHM RN	6270	HD		LD	LM			
			HH		LH	LDH			
			HM		LM	LDM			
			HHM		LDH	LHM			
			HDH		LHM	LN			
			HDM		LDM	RD			
			HN		LN	RH			
			RD		RD	RM			
			RH		RH	RDH			
			RM		RM	RDM			
			RDH	RDH	RHM				
			RDM	RDM	RN				
273	CD CH CM CDH CHM CN	6273	CD	7273	CD				
			CH		CH				
			CM		CM				
			CDH		CDH				
			CHM		CHM				
CN	CN								
275	S LA LB LC LE LF LG LJ LK LL RA RB RC RE RF RG RJ RK RL	6275	HA		LA	LA			
			HB		LB	LC			
			HC		LC	LE			
			HE		LE	LF			
			HF		LF	LJ			
			HG		LG	LK			
			HJ	LJ	LL				
			HK	LK	RA				
			HL	LL	RB				
			278	CA CB CC CE CF CG CJ CK CL CR	6278	CA	7275	LC	
						CB		LE	
						CC		LF	
CE	LG								
CF	LJ								
CG	LK								
CJ	LJ								
CK	LK								
CL	LK								
CR	LL								
278	CA CB CC CE CF CG CJ CK CL CR	6278				CA		7278	RA
						CB			RB
			CC	RC					
			CE	RE					
			CF	RF					
			CG	RG					
			CJ	RJ					
			CK	RK					
			CL	RL					
			CR	CA					
									CB
									CC
					CE				
					CF				
					CG				
					CJ				
					CK				
					CL				
					CR				

### For Multiplex Masterkey Systems (L keyway family shown, others similar)

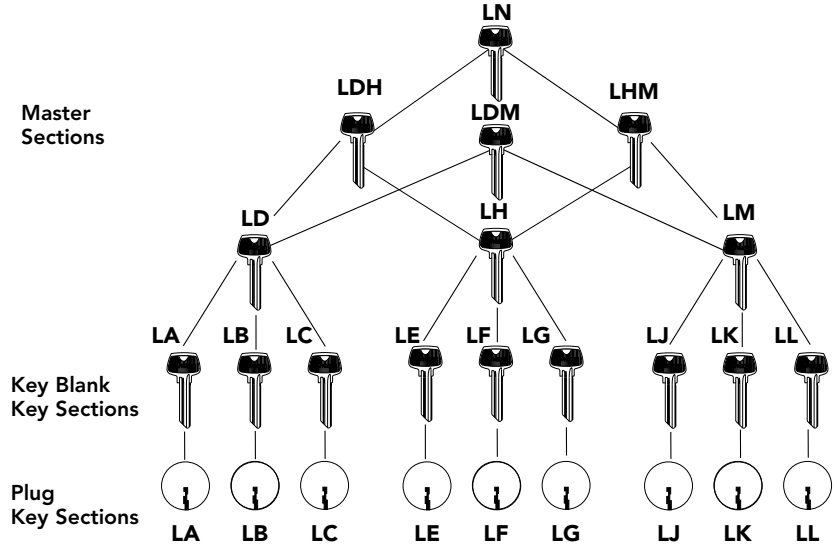

### Multi Keyway Systems

- L – System Stock Keyways
- C – System Hotel Keyway (Furnished in Large Bow only)
- H – System Contract Master Key Systems
- R – System Contract MasterKey Systems

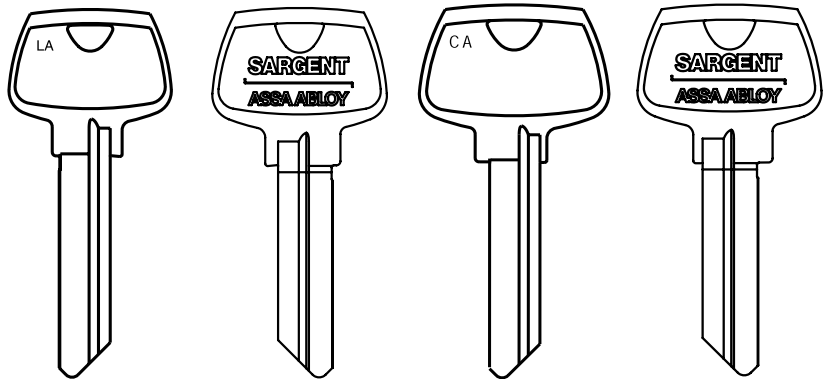

Standard 6 pin

Large Bow approximately 15% larger than standard bow. Provided for SARGENT "C" family as standard.

### Single Keyway Sections

- R Section \*
- S Section
- U Section\*
- CR Section

\* Cylinders ordered in either U or R single section only. Offered as 1 bitted for field keying

**Restricted Keyways:** Restricted keyways are SARGENT (factory) controlled geographically to limit sales and prevent unauthorized key duplication.

For availability of restricted keyways and key sections, contact SARGENT Key Records Department.

Orders for restricted keyway systems, key blanks and cylinders, require a letter of authorization from the system owner.

Key blanks sold in boxes of 50

### BITTING LISTS

Paper bitting lists provided at no charge for factory corresponding keyed orders when requested at time of hardware order. An owners letter of authorization must be attached to all purchase orders Existing key system bittings lists also available contact key records for more information.

Copyright © 2006-2022, Sargent Manufacturing Company, an ASSA ABLOY Group company. All rights reserved. Reproduction in whole or in part without the express written permission of Sargent Manufacturing Company is prohibited.

90622 08/22

# Visual Key Control and Tamper Proof Packaging

## Cylinders and Components

### Visual Key Control (Stamping)

To allow for easier key and cylinder identification, SARGENT offers the option for permanent stamping of keys and/or cylinder with industry standard alpha-numeric keyset symbols.

Non-visual key control stamped change (day) keys include bitting numbers as standard, (Item A) unless specified in keying order lead sheet submitted with order requesting to be omitted and key set substituted.

Degree, SFIC and Signature change keys are stamped with key set symbols as standard.

Master level keys do not include bitting numbers. Master level keys include system register numbers stamped on the first line, and the standard visual key control designations on the second line (Item B).

#### Up to 7 characters available for permanent stamping for Visual Key Control

- Key and cylinder identified by industry standard alpha-numeric keyset symbols
- Easy visual identification on the face of the plug (Item C or Item G or H) not available with XC, Signature or SFIC cylinders
- Concealed stamping on mortise and rim cylinders and bored lock cylinders available on the slide only (Item D or I)
- Cylinder-slide stamping available on 5100 and 6300 SARGENT Large Format Interchangeable (Removable) Cores, bored lock, mortise/rim cylinders (Item D, E & I)
- Core side engraving available for 7300B Series up to 7 characters (Item F)
- Special key stampings available, such as "DO NOT DUPLICATE" or "CITY OF PHOENIX"
- Degree, XC, and Signature cylinders not available with visual plug stamping
- Degree, XC, and Signature cylinders available with only concealed slide stamping (Item D, E and I) only
- Degree, XC, and Signature Large Format Interchangeable (Removable) Cores 10-6300 available with cylinder slide stamping (Item E, I D)

**Note:** SARGENT will stamp alternate identity codes on cylinders and/or keys whenever requested. This alternate stamping can not be different if both are to be stamped. Master Level Keys can also be stamped with a single alternate code. Alternate stamping must be consistent for key set on entire order for key and/or cylinder.

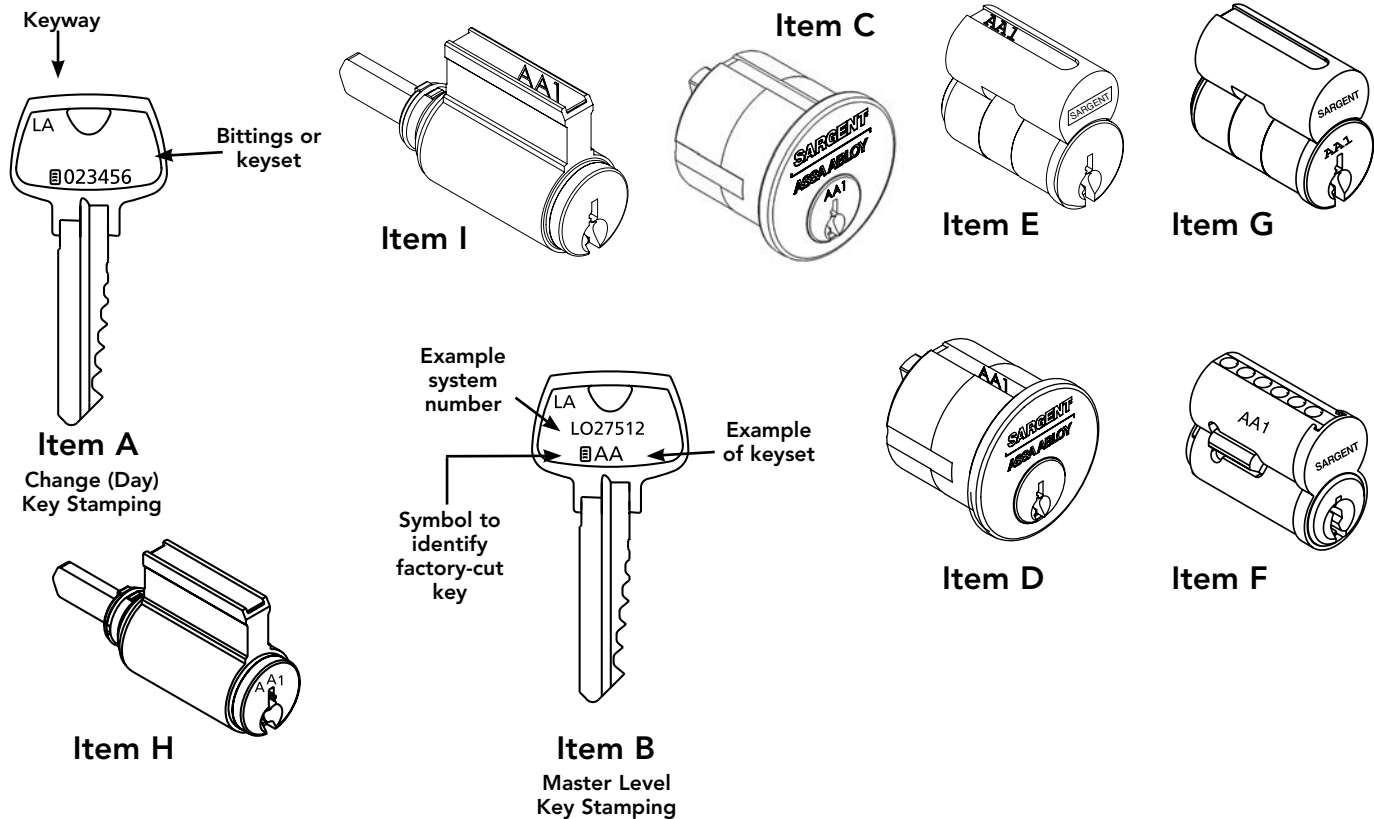

### Tamper Proof Packaging

For the highest level of security for the end user, Tamper Proof Packaging is used on all Master Keys, Signature key blanks and all restricted key blanks. This heat sealed shrink wrap identified with "SARGENT Sealed For Your Security" provides assurance of the integrity of the factory generated key system.

# Master Keying and Cylinder Terms

## Cylinders and Components

SARGENT requires all orders containing Master Keying details to be submitted using the industry standard D.H.I. ANSI/BHMA format. Key Symbols used on a master keyed order require combinations of letters and/or letters and numbers.

For complete details on proper structuring format of key symbols refer to:

D.H.I. Handbook Section 8 Finish Hardware KEYING SYSTEMS AND NOMENCLATURE or, ANSI/BHMA Standard A156.28, AMERICAN NATIONAL STANDARDS FOR KEYING SYSTEMS.

Or contact SARGENT for assistance.

### Basic Keying Terms

Keys and terms	Abbreviation	Definition
Change key	CK	Individual lock key
Masterkey	MK	Operates any given quantity of cylinders with different key changes
Grand Masterkey	GMK	Operates all individual locks already operated by masterkey(s)
Great Grand Masterkey	GGMK	Operates all locks under the various masterkey(s) and grand master key(s) already established
Emergency Key	EMK	Operates hotel locks having shut out feature which blocks entry by all other keys
Construction key	CMK	Operates all cylinders designated for a temporary period during construction
Control Key	CTL	Key to install or remove interchangeable or removable cores
Keyway	KWY	Broaching in a cylinder plug
Key section	KWY	Sidewarding on key to match broaching in plug
Single keyed	SKD	Cylinders operated by their change key only; not operated by any master key

### Cylinder Terms

ALOA* adopted terms	Alternate terms
Shell	Cylinder body, Cylinder shell
Plug	Barrel, Cylinder barrel
Tail Piece	Connecting bar
Bottom Pins	Key pin, Ball end pins
Master Pins	Splits, Chips
Top Pins	Drivers
Change Key	Day key
Key Cut	Bit

\* Associated Locksmiths of America

### Examples of Master Key System Levels and Symbol Structure\*\*

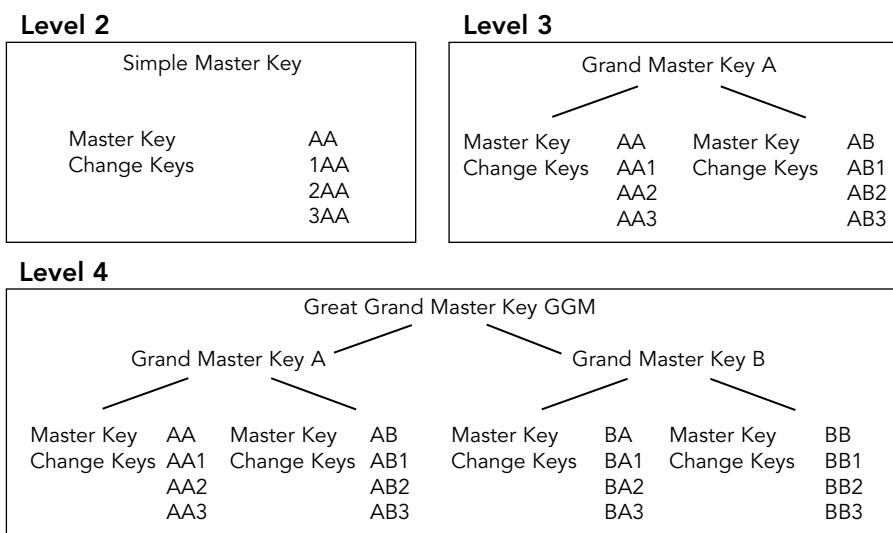

\*\* Master key system levels greater than Level 4 are not recommended. Contact SARGENT Key Records for additional information

# Master Keying and Cylinder Terms

## Cylinders and Components

All orders for keys require keyset symbols, system registry number, and catalog part number.

### **Cut change keys**

5 pin 272 CHK  
6 PIN 6272CHK  
7 PIN 7272 CHK

### **Cut Master key**

5 pin 272MK  
6 pin 6272 MK  
7 pin 7272 MK

### **Emergency Keys**

6267EMK bored locks emergency key 6 pin  
7268EMK mortise locks Emergency key 7 pin  
7269EMK Emergency key removable core mortise hotel function 7 pin /6 pin system

### **Control Key**

6272CTL (63-)  
6255CTL (63- 1 bitted)  
7253 CTL (51- 7 pin)

### **Construction master keys**

6272CMK for 6 pin 21-

### **Large format construction cores**

6251CMK (64-) construction master  
6251 CTL (64-) construction control key

### **Small Format construction core**

6282BCMK 6 pin 72- construction master  
6254BCTL 6 pin 72- Construction control key

7282BCMK 7 pin 11-72 (XC) Construction Master key  
7254BCTL 7 pin 11-72 (X)

The ASSA ABLOY Group is the global leader in access solutions. Every day, we help billions of people experience a more open world.

ASSA ABLOY Opening Solutions leads the development within door openings and products for access solutions in homes, businesses and institutions. Our offering includes doors, frames, door and window hardware, mechanical and smart locks, access control and service.

**SARGENT**<sup>®</sup>  
**ASSA ABLOY**

SARGENT Manufacturing Company  
100 Sargent Drive  
New Haven, CT 06511 USA  
800-727-5477  
[www.sargentlock.com](http://www.sargentlock.com)

Founded in the early 1800s, SARGENT<sup>®</sup> is a market leader in locksets, cylinders, door closers, exit devices, electro-mechanical products and access control systems for new construction, renovation, and replacement applications. The company's customer base includes commercial construction, institutional, and industrial markets.

Copyright © 2006-2022, SARGENT Manufacturing Company. All rights reserved. Reproduction in whole or in part without the express written permission of SARGENT Manufacturing Company is prohibited. Patent pending and/or patent [www.assaabloydss.com/patents](http://www.assaabloydss.com/patents).